

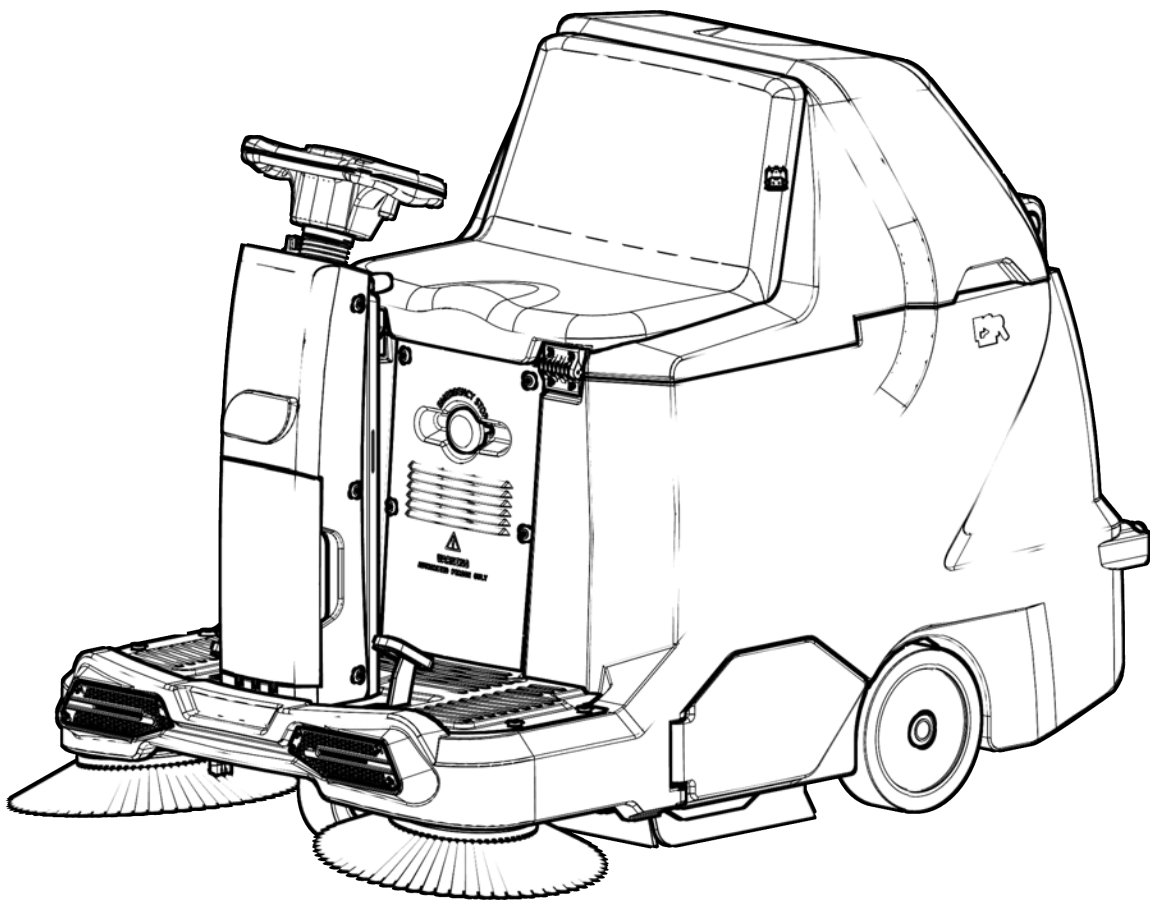

## WORKSHOP HANDBOOK

### FSR



Version: **AA**

Date: **February 11, 2014**

Document Number: **10046657**

# Contents

<b>I</b>	<b>Product Introduction</b>	<b>5</b>
<b>1</b>	<b>Serial Number and Technical Support</b>	<b>6</b>
1.1	The Serial Tag . . . . .	6
1.2	Serial Tag location . . . . .	6
<b>2</b>	<b>Main Technical Features</b>	<b>7</b>
<b>II</b>	<b>Anomalies Resolution Guide</b>	<b>9</b>
<b>3</b>	<b>Trouble-shooting for the most common anomalies</b>	<b>10</b>
3.1	Electrical system: what to do if. . . . .	10
3.2	Main broom system: what to do if. . . . .	13
3.3	Side broom system: what to do if. . . . .	14
3.4	Vacuum system: what to do if. . . . .	15
3.5	Frame and traction system: what to do if. . . . .	16
3.6	Endothermic Engine: what to do if. . . . .	17
<b>4</b>	<b>Disassembling Procedures</b>	<b>18</b>
4.1	Electrical Installation . . . . .	19
4.2	Main Broom System . . . . .	23
4.3	Side Broom System . . . . .	26
4.4	Vacuum System . . . . .	28
4.5	Frame and Traction System . . . . .	30
4.6	Endothermic Engine System . . . . .	33
<b>III</b>	<b>Machine Description</b>	<b>35</b>
<b>5</b>	<b>Electrical System</b>	<b>36</b>
5.1	Structure . . . . .	36
5.2	Description . . . . .	37
5.3	Adjustments . . . . .	49
5.4	Maintenance and Checks . . . . .	51
5.5	Alarm Table . . . . .	52
5.6	Menu tables . . . . .	53
5.7	Technical Features . . . . .	59
5.8	Recommended Spare Parts . . . . .	59

<b>6</b>	<b>Main Sweeping System</b>	<b>60</b>
6.1	Structure . . . . .	60
6.2	Description . . . . .	60
6.3	Adjustments . . . . .	61
6.4	Maintenance and checks . . . . .	61
6.5	Technical Features . . . . .	63
6.6	Consumable Spare Parts . . . . .	63
6.7	Recommended Spare Parts . . . . .	63
<b>7</b>	<b>Side Brush System</b>	<b>64</b>
7.1	Structure . . . . .	64
7.2	Description . . . . .	64
7.3	Adjustment . . . . .	65
7.4	Maintenance and checks . . . . .	66
7.5	Technical Features . . . . .	67
7.6	Consumable Spare Parts . . . . .	67
7.7	Recommended Spare Parts . . . . .	67
<b>8</b>	<b>Vacuum System</b>	<b>68</b>
8.1	Structure . . . . .	68
8.2	Description . . . . .	68
8.3	Adjustments . . . . .	70
8.4	Maintenance and Checks . . . . .	70
8.5	Technical Features . . . . .	72
8.6	Consumable Spare Parts . . . . .	72
8.7	Recommended Spare Parts . . . . .	72
<b>9</b>	<b>Collection System</b>	<b>73</b>
9.1	Structure . . . . .	73
9.2	Description . . . . .	73
9.3	Maintenance and Checks . . . . .	74
9.4	Technical Features . . . . .	75
9.5	Consumable Spare Parts . . . . .	75
<b>10</b>	<b>Machine Frame and Traction System</b>	<b>76</b>
10.1	Structure . . . . .	76
10.2	Description . . . . .	76
10.3	Adjustments . . . . .	77
10.4	Maintenance and Checks . . . . .	77
10.5	Technical Features . . . . .	80
10.6	Consumable spare parts . . . . .	80
10.7	Recommended Spare Parts . . . . .	80
<b>11</b>	<b>Endothermic engine (FSR Hybrid)</b>	<b>81</b>
11.1	Structure . . . . .	81
11.2	Description . . . . .	81
11.3	Operation of the Hybrid Model . . . . .	82
11.4	Endothermic Engine . . . . .	84
11.5	Maintenance and Checks . . . . .	85

11.6 Warnings . . . . .	87
11.7 Technical Features . . . . .	88

**IV Accessories and Add-On 89**

<b>12 Accessories 90</b>	<b>90</b>
12.1 Accessories List . . . . .	90
12.2 Blinking Kit - 223421 . . . . .	90
12.3 Onboard Charger Kit (only FSR B) - 223390 . . . . .	92

**Part I**

**Product Introduction**

# Chapter 1

## Serial Number and Technical Support

### 1.1 The Serial Tag

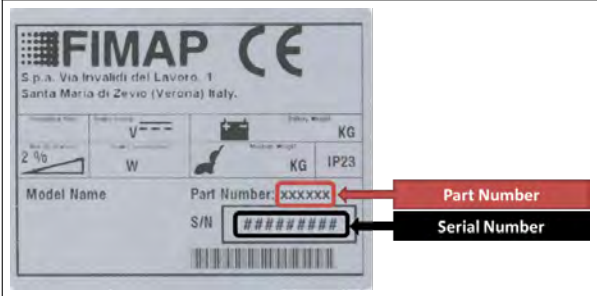

### 1.2 Serial Tag location

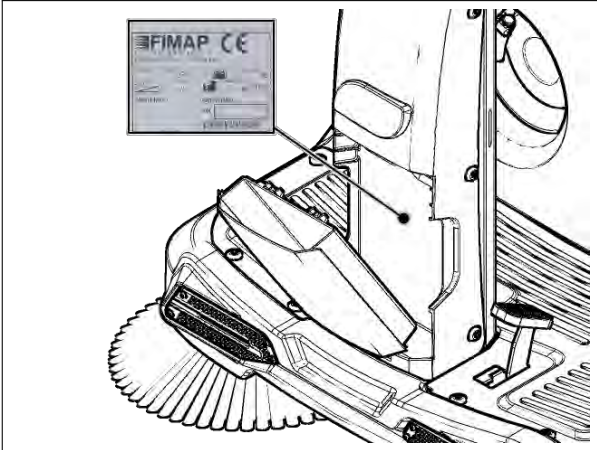

To have access to the Serial Tag is necessary to open the glove box on the steering column. The Serial Number is an extremely important information which has to be provided each time a Technical Support is required or is necessary to buy spare parts or accessories. The serial number is the only way to identify the machine by model, production date type equipments in general.

# Chapter 2

## Main Technical Features

### Technical Data

<b>TECHNICAL DESCRIPTION</b>	<b>U/M</b>	<b>FSR B</b>	<b>FSR Hybrid</b>
Working Width <i>(without side brush)</i>	mm	580	580
Working Width <i>(with side brush)</i>	mm	790	790
Working Width <i>(with double side brush)</i>	mm	1000	1000
Working capacity, up to	$\frac{m^2}{h}$	4500	4500
Steering Diameter	mm	3600	3600
Total Power	W	1250	1250
Maximum Ramp Gradient	%	10	10
Machine length	mm	1455	1455
Machine Width <i>(without side brush)</i>	mm	845	845
Machine Width <i>(with side brush)</i>	mm	920	920
Machine Width <i>(with double side brush)</i>	mm	1000	1000
Machine Height	mm	1030	1030
Machine Height <i>(with optional blinking kit)</i>	mm	1080	1080
Wheel Base	mm	700	700
Wheel Track	mm	720	720
Footrest height from the ground	mm	236	236
Seat height from the footrest	mm	503	503
Sound pressure level (ISO 11201)	LpA dB (A)	60.5	81.2
Sound power level (ISO 3744)	LWA dB (A)		
Hand vibration level (ISO 5349)	$\frac{m}{s^2}$	≤ 2.5	≤ 2.5
Body vibration level (ISO 2631)	$\frac{m}{s^2}$	≤ 0.5	≤ 0.5

## Weights and Pressures<sup>1</sup>

TECHNICAL DESCRIPTION	U/M	FSR B	FSR Hybrid
Machine Weight <i>(without batteries)</i>	kg	175	
Machine Weight <i>(without fuel)</i>	kg		252
Gross Weight of the machine in work conditions <i>(machine + batteries + brushes + operator)</i>	kg	323	
Gross Weight of the machine in work conditions <i>(machine + batteries + brushes + fuel + operator)</i>	kg		325
Weight front wheel	kg	81.00 ÷ 61.70	78.00 ÷ 58.70
Front wheel pressure	$\frac{kg}{cm^2}$	- ÷ -	- ÷ -
Weight rear right wheel	kg	85.20 ÷ 126.20	80.00 ÷ 121.5
Rear right wheel pressure	$\frac{kg}{cm^2}$	- ÷ -	- ÷ -
Weight rear left wheel	kg	82.20 ÷ 123.20	94.00 ÷ 135.50
Rear left wheel pressure	$\frac{kg}{cm^2}$	- ÷ -	- ÷ -

<sup>1</sup>Weight and Pressures depends on how many debris there are in the tray hopper and on what type of battery the machine fits.



# Part II

## Anomalies Resolution Guide

## Chapter 3

# Trouble-shooting for the most common anomalies

### 3.1 Electrical system: what to do if...

<b>The machine doesn't switch on</b>		
1. The emergency button is pressed	⇒	<i>Release the emergency button.</i>
2. The key is in position 0	⇒	<i>Rotate the key in position I.</i>
3. The key switch is not properly connected	⇒	<i>Restore the proper connections.</i>
4. The key switch doesn't work	⇒	<i>Replace the key switch (see section 4.1.1 at page 19).</i>
5. The machine is not supplied	⇒	<i>Check the proper section (see section 3.1 at page 11).</i>

---

### The batteries don't work properly

---

- |   |   |  |
|---|---|--|
| 1. The batteries are not properly connected   | ⇒ | <i>Restore the proper battery connections.</i>   |
| 2. The batteries are discharged   | ⇒ | <i>Perform a complete charge cycle.</i>  |
| 3. Battery terminal are oxidized  | ⇒ | <i>Disconnect the batteries, clean the batteries terminals and reconnect properly the batteries.</i>                         |
| 4. With the machine in working conditions one battery has a voltage lower (difference higher than 2 V) than the other one/s | ⇒ | <i>If the batteries have run less than 30 charge cycles, replace the battery with lower voltage, otherwise replace both.</i> |
| 5. The fuse on the loop wire is damaged   | ⇒ | <i>Check for possible short circuits, If not present replace the loop wire.</i>  |
| 6. The power wires are damaged  | ⇒ | <i>Replace the damaged wires.</i>  |
| 7. The battery charger doesn't work   | ⇒ | <i>Check the proper section (see section 3.1 at page 11).</i>  |
- 

---

### The battery charger doesn't work

---

- |   |   |  |
|---|---|--|
| 1. The battery charger is not connected to the power supply                   | ⇒ | <i>Connect the charger to a supplied electric socket.</i>  |
| 2. The battery charger is not connected to the batteries                      | ⇒ | <i>Connect the charger to the batteries.</i>   |
| 3. The battery charger is not properly adjusted                               | ⇒ | <i>Adjust properly the battery charger.</i>  |
| 4. The battery charger has one or more lights (or LEDs) blinking continuously | ⇒ | <i>The battery charger is in error conditions, verify the alarm tables and solve the issue by following the related instructions (see section 5.3.3 at page 50).</i> |
| 5. The battery charger is properly connected but it doesn't switch on         | ⇒ | <i>Replace the battery charger.</i>  |
-

---

### The display shows an alarm message

---

1. The display shows an alarm message ⇒ *Check what alarm message is shown and solve the related issue by following the proper instructions (see section 5.5.1 at page 52).*
- 

---

### The machine has a very limited working autonomy

---

1. The batteries connections are oxidized ⇒ *Unplug the connection wires, wash the wire connections with water and reconnect them protecting them with grease.*
  2. With the machine in working conditions one battery has a voltage lower (difference higher than 2 V) than the other ones ⇒ *If the batteries have run less than 30 charge cycles, replace the battery with lower voltage, otherwise replace both.*
  3. The battery charger is not properly adjusted ⇒ *Verify the type of battery in use and adjust the battery charger properly following the instructions (see section 5.3.3 at page 50).*
  4. The BDI (Battery Discharge Indicator) is not properly adjusted ⇒ *Verify the type of battery used on the machine and adjust properly the BDI.*
  5. Batteries have been working for several cycles ⇒ *Replace the batteries.*
-

## 3.2 Main broom system: what to do if...

<b>The machine doesn't clean well</b>		
1.	The machine is switched off	⇒ <i>Switch on the machine.</i>
2.	The machine doesn't switch on	⇒ <i>Refer to the proper section (see section 3.1 at page 10).</i>
3.	The display shows an alarm message	⇒ <i>Check what alarm message is shown and solve the related issue by following the proper instructions (see section 5.5.1 at page 52).</i>
4.	The microswitch of the main broom lifting lever doesn't work	⇒ <i>Replace the microswitch (see section 4.1.5 at page 20).</i>
5.	The main broom motor is not powered properly	⇒ <i>Check the power connections of the motor.</i>
6.	The carbon brushes are worn out	⇒ <i>Replace the carbon brushes.</i>
7.	The main broom motor is supplied but it doesn't work	⇒ <i>Replace the motor.</i>
8.	The brush rotates in opposite way	⇒ <i>Check the motor connections.</i>
9.	The brush is not properly engaged	⇒ <i>Release and engage properly the brush.</i>
10.	The brush is dirty or worn	⇒ <i>Release Clean or replace the brush.</i>

### 3.3 Side broom system: what to do if...

---

#### **The machine doesn't clean well**

---

1.	The machine is switched off	⇒	<i>Switch on the machine.</i>
2.	The machine doesn't switch on	⇒	<i>Refer to the proper section (see section 3.1 at page 10).</i>
3.	The display shows an alarm message	⇒	<i>Check what alarm message is shown and solve the related issue by following the proper instructions (see section 5.5.1 at page 52).</i>
4.	The microswitch of the side broom lifting lever doesn't work	⇒	<i>Replace the microswitch (see section 4.1.5 at page 20).</i>
5.	The side broom motor is not powered properly	⇒	<i>Check the power connections of the motor.</i>
6.	The carbon brushes are worn out	⇒	<i>Replace the carbon brushes.</i>
7.	The side broom motor is supplied but it doesn't work	⇒	<i>Replace the motor.</i>
8.	The brush rotates in opposite way	⇒	<i>Check the motor connections.</i>
9.	The brush is not properly engaged	⇒	<i>Release and engage properly the brush.</i>
10.	The brush is dirty or worn	⇒	<i>Release Clean or replace the brush.</i>

---

### 3.4 Vacuum system: what to do if...

---

#### **The machine does not vacuum well**

---

- |   |   |  |
|---|---|--|
| 1. The machine is switched off  | ⇒ | <i>Switch on the machine.</i>                                    |
| 2. The machine doesn't switch on                                      | ⇒ | <i>Refer to the proper section (see section 3.1 at page 10).</i> |
| 3. The vacuum motor is switched off                                   | ⇒ | <i>Switch on the vacuum motor.</i>                               |
| 4. The vacuum motor doesn't switch on                                 | ⇒ | <i>Refer to the proper section (see section 3.4 at page 15).</i> |
| 5. The rubbers of the central tunnel are worn or broken               | ⇒ | <i>Rotate or replace the rubbers.</i>                            |
| 6. The vacuum filter is dirty or clogged                              | ⇒ | <i>Remove and clean the vacuum filter.</i>                       |
| 7. The gaskets of the filter suction chamber does not adhere properly | ⇒ | <i>Check and if necessary replace the gaskets.</i>               |
- 

---

#### **The vacuum motor doesn't work properly**

---

- |   |   |   |
|---|---|---|
| 1. The vacuum motor is not powered properly         | ⇒ | <i>Check the power connections of the vacuum motor.</i>   |
| 2. The microswitch of the vacuum motor doesn't work | ⇒ | <i>Replace the microswitch.</i>   |
| 3. The display shows an alarm message               | ⇒ | <i>Check what alarm message is shown and solve the related issue by following the proper instructions (see section 5.5.1 at page 52).</i> |
| 4. The vacuum motor carbon brushes are worn out     | ⇒ | <i>Replace the carbon brushes.</i>  |
| 5. The vacuum motor is supplied but it doesn't work | ⇒ | <i>Replace the vacuum motor.</i>  |
- 

---

#### **The filter shaker doesn't work properly**

---

- |  |   |  |
|--|---|--|
| 1. The filter shaker is not powered properly         | ⇒ | <i>Check the power connections of the filter shaker.</i> |
| 2. The microswitch of the filter shaker doesn't work | ⇒ | <i>Replace the microswitch.</i>                          |
| 3. The filter shaker is supplied but it doesn't work | ⇒ | <i>Replace the filter shaker.</i>                        |
-

### 3.5 Frame and traction system: what to do if...

---

#### **The traction motor doesn't work properly**

---

1.	The machine is switched off	⇒	<i>Switch on the machine.</i>
2.	The machine doesn't switch on	⇒	<i>Check the proper section (see section 3.1 at page 10).</i>
3.	The batteries are discharged	⇒	<i>Connect the battery charger and perform a complete charge cycle.</i>
4.	The operator is not sitting on the seat	⇒	<i>The operator must sit on the seat.</i>
5.	The operator is sitting on the seat	⇒	<i>Check and / or replace the deadman seat microswitch.</i>
6.	The pedal is not pressed	⇒	<i>Press the pedal depending on the required speed.</i>
7.	The pedal is pressed	⇒	<i>Check and / or replace the potentiometer or the microswitch inside the pedal.</i>
8.	The display shows an alarm message	⇒	<i>Check what alarm message is shown and solve the related issue by following the proper instructions (see section 5.5.1 at page 52).</i>
9.	The traction motor is not supplied	⇒	<i>Check the power connections of the motor.</i>
10.	The traction motor carbon brushes are worn out	⇒	<i>Replace the carbon brushes.</i>
11.	The traction motor is supplied but it doesn't work	⇒	<i>Replace the motor.</i>
12.	The electrobrake doesn't disengage	⇒	<i>Check the connections of the electrobrake.</i>

---



### 3.6 Endothermic Engine: what to do if...

**Attention:** Refer to the specific manual of the manufacturer supplied with the machine.

---

#### The engine doesn't start

---

- |  |   |  |
|--|---|--|
| 1. Check the control positions on the motor        | ⇒ | <i>Turn engine switch to ON position. Open the fuel valve, Move the lever to CLOSED position unless the engine is warm.</i>  |
| 2. Check fuel                                      | ⇒ | <i>Make sure that the fuel is in the tank and that it is not of poor quality.</i>  |
| 3. Remove and inspect spark plug                   | ⇒ | <i>Make sure that the Spark plug is not faulty, fouled, or improperly gapped, different than 0,70 - 0,80 mm. if the spark plug is wet, dry and reinstall it. Start the engine with throttle lever in MAX position.</i> |
| 4. Check the engine oil level                      | ⇒ | <i>if the engine oil level is too low, drain the exhaust oil and fuel the tank with recommended oil to the proper level.</i>   |
| 5. Despite the controls, the problem is not solved | ⇒ | <i>Take the engine to an authorized Honda servicing dealer, or refer to the motor workshop manual.</i>   |
- 

---

#### The engine loses power

---

- |  |   |  |
|--|---|--|
| 1. Check the air filter                            | ⇒ | <i>Clean or replace filter element(s).</i>   |
| 2. Check the fuel                                  | ⇒ | <i>Drain the fuel tank and the carburetor. Refuel with fresh gasoline.</i>                             |
| 3. Despite the controls, the problem is not solved | ⇒ | <i>Take the engine to an authorized Honda servicing dealer, or refer to the motor workshop manual.</i> |
-

## Chapter 4

# Disassembling Procedures

**WARNING:** BEFORE TO PERFORM ANY OPERATION DESCRIBED BELOW VERIFY THAT THE MACHINE IS TURNED OFF. DISCONNECT THE BATTERIES AND REMOVE THEM FROM THE MACHINE. FURTHERMORE, VERIFY THAT THE PARKING BRAKE (ELECTROBRAKE) IS ENGAGED AND THE MACHINE IS IN A TOTALLY SAFE CONDITION. IN THE ENDOTHERMIC ENGINE VERSION, MAKE SURE THAT THE FUEL TANK IS EMPTY, IF NOT, DRAIN IT COMPLETELY.

## 4.1 Electrical Installation

### 4.1.1 Key Switch

- Put the machine in safe conditions.
- Remove the screws that secure the front carter to the steering column (see fig. 4.1.1-1).
- Disconnect the wires connected to the key switch.
- Unscrew the ring nut that secures the key switch to the steering column (see fig. 4.1.1-2).
- Remove the key switch.
- Proceed at reverse to refit the part.

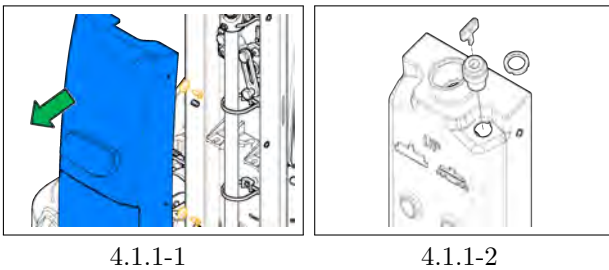

4.1.1-1

4.1.1-2

### 4.1.2 Steering Control Card

- Put the machine in safe conditions.
- Remove the screws that secure the upper and lower part of the steering wheel (see fig. 4.1.2-3).
- Separate the top part from the bottom part.
- Disconnect the communication cable between the Control card and the Main card (see fig. 4.1.2-4).
- Unscrew the screws on the control card from the top part and remove the card (see fig. 4.1.2-4).
- Proceed at reverse to refit the part.

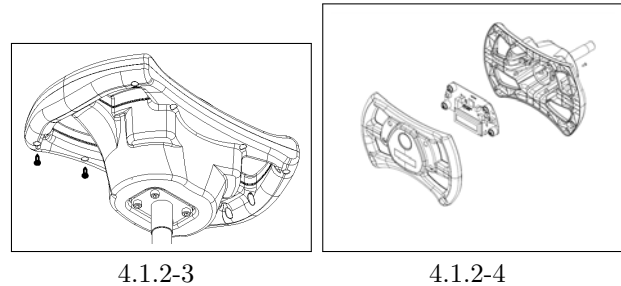

4.1.2-3

4.1.2-4

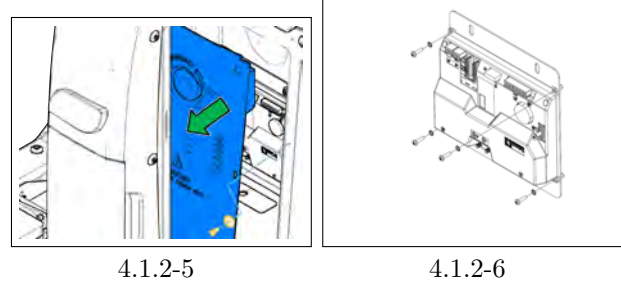

4.1.2-5

4.1.2-6

### 4.1.3 Main Card FSR B

- Put the machine in safe conditions.
- Remove the screws of the footrest without removing it.
- Remove the screws to remove the electrical system cover (see fig. 4.1.2-5).
- Disconnect the electrical wiring of the Main card.
- Remove the screws that secure the card to the support bracket and remove the card (see fig. 4.1.2-6).
- Proceed at reverse to refit the part.

### 4.1.4 Main Card FSR H

- Put the machine in safe conditions.
- Lift the upper body / seat.
- Loosen the screws to remove the card protection cover (see fig. 4.1.4-7).
- Disconnect the electrical wiring of the Main card.
- Remove the screws that secure the card to the support plate to the frame (see fig. 4.1.4-8).

- Remove the card.
- Proceed at reverse to refit the part.

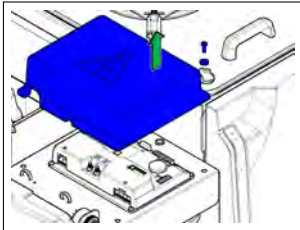

4.1.4-7

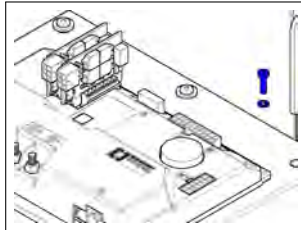

4.1.4-8

### 4.1.5 Microswitch

- Put the machine in safe conditions.
- Remove the screws that secure the front carter to the steering column (see fig. 4.1.5-9).
- Disconnect the wires connected to the microswitch.
- To remove the microswitch, unscrew the two screws and remove the device (see fig. 4.1.5-10).
- Proceed at reverse to refit the part.

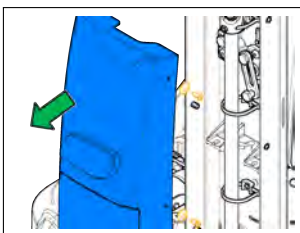

4.1.5-9

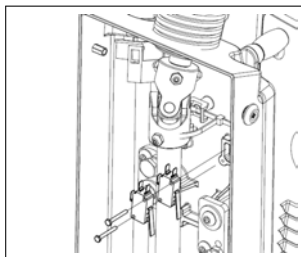

4.1.5-10

### 4.1.6 Emergency Button FSR B

- Put the machine in safe conditions.
- Remove the screws to remove the electrical system cover (see fig. 4.1.6-11).

- Disconnect the electrical wiring of the emergency button (see fig. 4.1.6-12).
- Remove the screws to remove the emergency button (see fig. 4.1.6-13).
- Proceed at reverse to refit the part.

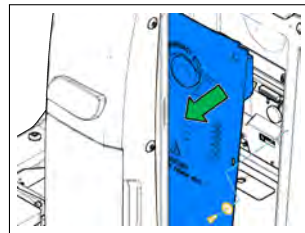

4.1.6-11

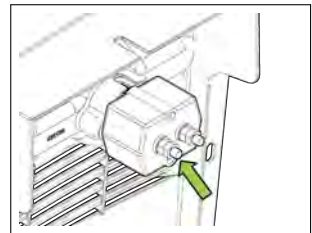

4.1.6-12

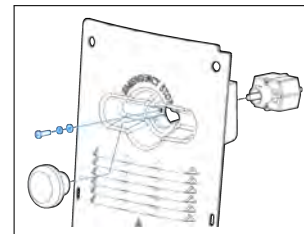

4.1.6-13

### 4.1.7 Emergency Button FSR H

- Put the machine in safe conditions.
- Remove the screws that secure the front carter to the steering column (see fig. 4.1.7-14).
- Disconnect the electrical wiring of the emergency button (see fig. 4.1.7-15).
- Remove the emergency button.
- Proceed at reverse to refit the part.

### 4.1.8 Traction Pedal

- Put the machine in safe conditions.
- Unscrew the screws that hold the traction pedal cover and remove it (see fig. 4.1.8-16).

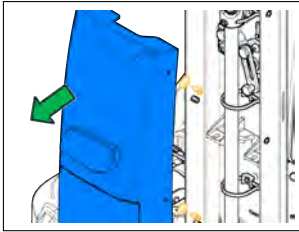

4.1.7-14

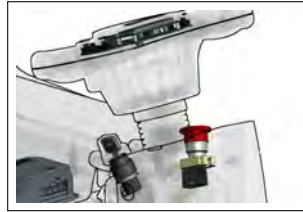

4.1.7-15

- Unscrew the screws that hold the flap pedal cover and remove it (see fig. 4.1.8-17).
- Remove the screws to remove the footrest (see fig. 4.1.8-18).
- Release the footswitch connector and unscrew the two screws holding the pre-assembly pedal (see fig. 4.1.8-19).
- Remove the pedal.
- Proceed at reverse to refit the part.

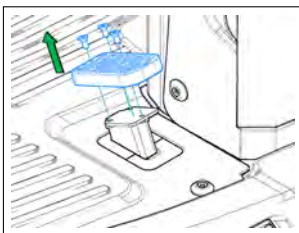

4.1.8-16

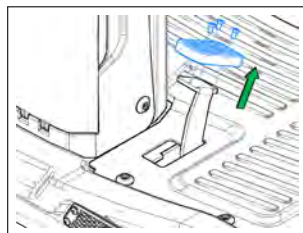

4.1.8-17

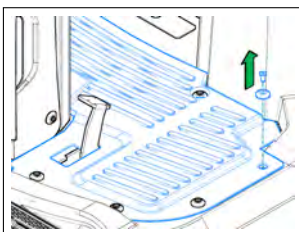

4.1.8-18

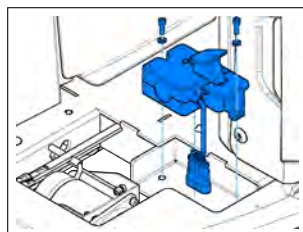

4.1.8-19

#### 4.1.9 Dead Man Switch (Seat microswitch)

- Put the machine in safe conditions.
- Remove the seat from the machine (see section 4.5.8 at page 32) (see fig. 4.1.9-20).

- Remove the switch connecting joints (see fig. 4.1.9-21).
- Remove the dead man Switch.
- Proceed at reverse to refit the part.

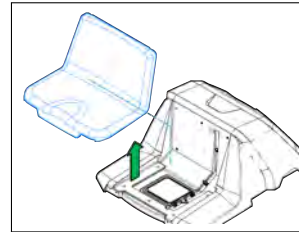

4.1.9-20

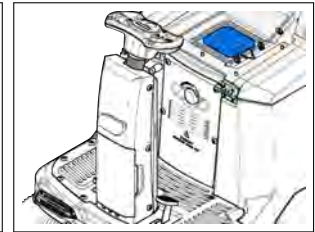

4.1.9-21

#### 4.1.10 Curve Speed Reduction Switch

- Put the machine in safe conditions.
- Unscrew the screws that hold the traction pedal cover and remove it (see fig. 4.1.10-22).
- Unscrew the screws that hold the flap pedal cover and remove it (see fig. 4.1.10-23).
- Remove the screws to remove the footrest (see fig. 4.1.10-24).
- Disconnect the wires connected to the switch (see fig. 4.1.10-25).
- Unscrew the two screws holding the switch to the frame and remove it together with the protective plate (see fig. 4.1.10-26).
- Proceed at reverse to refit the part.

#### 4.1.11 Headlight

- Put the machine in safe conditions.
- Remove the screws that secure the headlight cover to the machine body (see fig. 4.1.11-27).

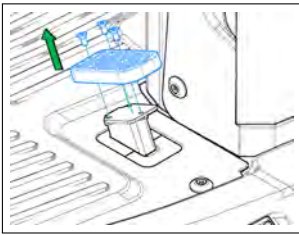

4.1.10-22

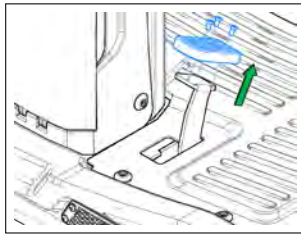

4.1.10-23

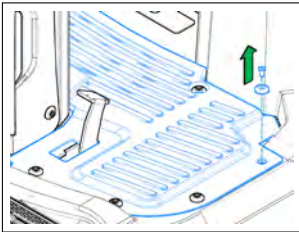

4.1.10-24

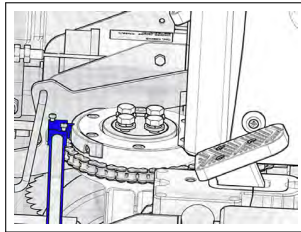

4.1.10-25

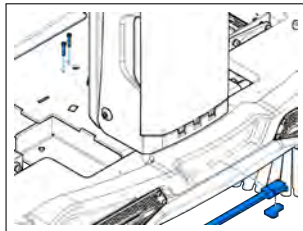

4.1.10-26

- Remove the screws that secure the main card support to the machine.
- Remove the batteries.
- Proceed at reverse to refit the part.



4.1.12-29

- Disconnect the headlight cables (see fig. 4.1.11-28).
- Remove the headlight from the headlight cover.
- Proceed at reverse to refit the part.

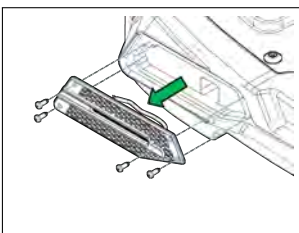

4.1.11-27

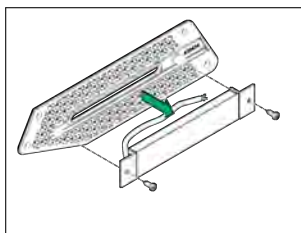

4.1.11-28

### 4.1.12 Batteries FSR H

- Put the machine in safe conditions.
- Remove the screws that secure the left side grid to the machine (see fig. 4.1.12-29).



## 4.2 Main Broom System

### 4.2.1 Side Carter

- Put the machine in safe conditions.
- Unscrew the pin and remove the side carter taking care not to lose the spacer (see fig. 4.2.1-30).
- Proceed at reverse to refit the part.

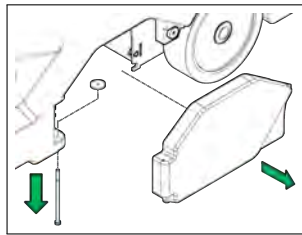

4.2.1-30

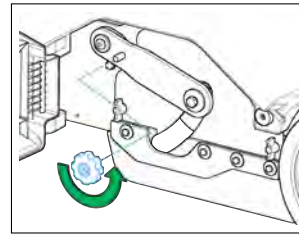

4.2.2-31

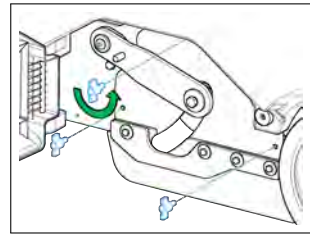

4.2.2-32

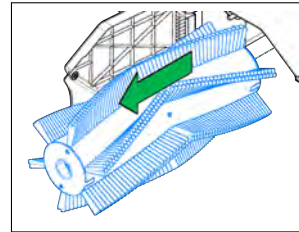

4.2.2-33

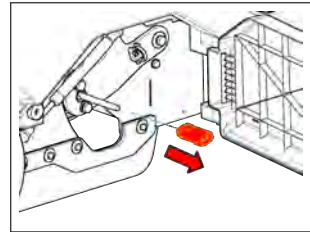

4.2.2-34

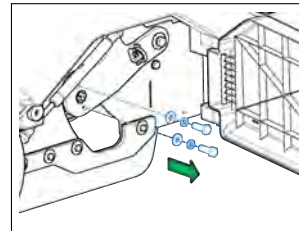

4.2.2-35

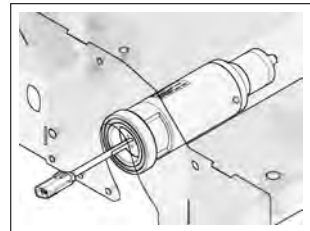

4.2.2-36

### 4.2.2 Main Broom

- Put the machine in safe conditions.
- Open the left side Carter.
- Unscrew the fixing knob (see fig. 4.2.2-31).
- Unscrew the fixing wing nuts and remove the lifting arm (see fig. 4.2.2-32).
- Pull the main brush lateral to the machine (see fig. 4.2.2-33).
- Remove the pentagon from the brush.
- Proceed at reverse to refit the part.

- Loosen the screws securing the motor to the machine (see fig. 4.2.2-35).
- Remove the motor (see fig. 4.2.2-36).
- Proceed at reverse to refit the part.

### 4.2.3 Main Broom Motor

- Put the machine in safe conditions.
- Open the right side Carter.
- Disconnect the brush motor connector (see fig. 4.2.2-34).

### 4.2.4 Main Broom Motor Bearing

- Put the machine in safe conditions.
- Disassemble the Main Broom Motor (see section 4.2.3 at page 23).
- Loosen the screws securing the motor bearing support.
- Remove the snap ring.
- Remove the bearing from the support (see fig. 4.2.4-37).
- Proceed at reverse to refit the part.

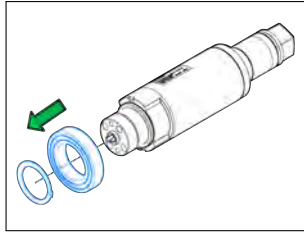

4.2.4-37

### 4.2.5 Main Broom Lifting Wire

- Put the machine in safe conditions.
- Remove the screws that secure the front carter to the steering column (see fig. 4.2.5-38).
- Remove the screw that secures the wire to the internal lifting lever of the the main broom (see fig. 4.2.5-39).
- Remove the connecting link that secures the lifting chain to the wire (see fig. 4.2.5-40).
- Unscrew the nuts securing the sheath to the frame and the steering column.
- Pull the main broom lifting wire.
- Proceed at reverse to refit the part.

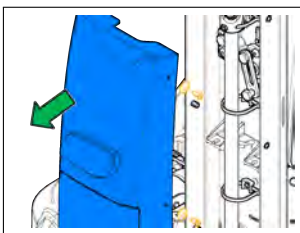

4.2.5-38

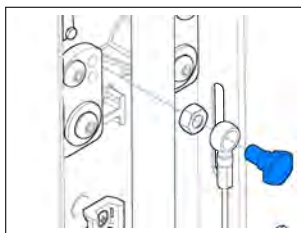

4.2.5-39

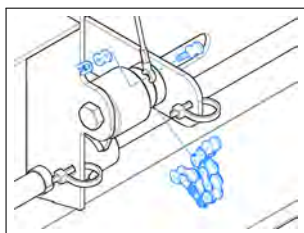

4.2.5-40

### 4.2.6 Main Broom Lifting Chain

- Put the machine in safe conditions.
- Remove the chain joints that fasten it to the wire and to the main brush lift lever (see fig. 4.2.5-40).
- Remove the chain.
- Proceed at reverse to refit the part.

### 4.2.7 Main Broom Gas Spring

- Put the machine in safe conditions.
- Open the right side carter.
- Loosen the fixing pins of the gas spring to the supports on the machine.
- Remove the Gas Spring (see fig. 4.2.7-41).
- Proceed at reverse to refit the part.

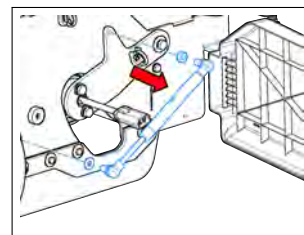

4.2.7-41

### 4.2.8 Side Flap

- Put the machine in safe conditions.
- Open the right side carter.
- Loosen the screws securing the flap to the support (see fig. 4.2.8-42).
- Remove the right side Flap being careful not to damage or lose the rubber blade.
- Do the same with the left side flap.
- Proceed at reverse to refit the part.



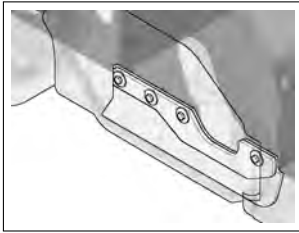

4.2.8-42

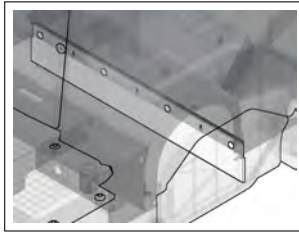

4.2.8-43

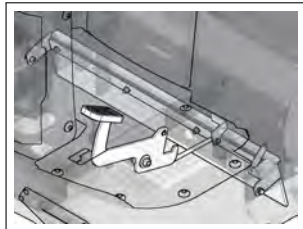

4.2.8-44

- Remove the screws to remove the footrest (see fig. 4.2.11-47).
- Unhook the flap control rod (see fig. 4.2.11-48).
- Unhook the return spring from the pedal.
- Unscrew the nut that hold the pedal to the frame (see fig. 4.2.11-49).
- Remove the pedal.
- Proceed at reverse to refit the part.

#### 4.2.9 Rear Flap

- Put the machine in safe conditions.
- Loosen the fixing screws of the rear flap (see fig. 4.2.8-43).
- Remove the rear Flap.
- Proceed at reverse to refit the part.

#### 4.2.10 Front Flap

- Put the machine in safe conditions.
- Loosen the fixing screws of the front flap to the support (see fig. 4.2.8-44).
- Remove the front Flap.
- Proceed at reverse to refit the part.



4.2.11-45

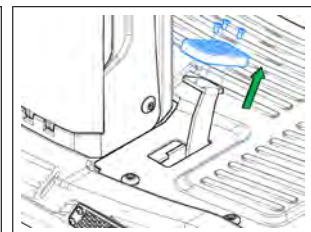

4.2.11-46

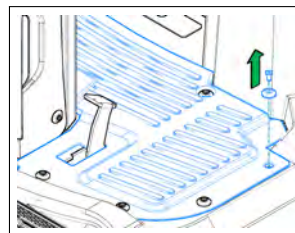

4.2.11-47

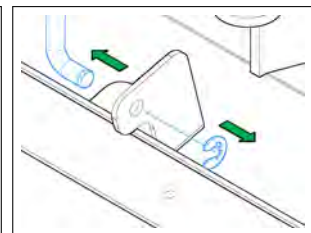

4.2.11-48

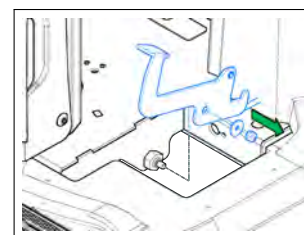

4.2.11-49

#### 4.2.11 Front Flap Pedal

- Put the machine in safe conditions.
- Unscrew the screws that hold the traction pedal cover and remove it (see fig. 4.2.11-45).
- Unscrew the screws that hold the flap pedal cover and remove it (see fig. 4.2.11-46).

#### 4.2.12 Front flap support

- Put the machine in safe conditions.
- Disconnect the front flap support release spring (see fig. 4.2.12-50).
- Remove the front flap pedal (see section 4.2.11 at page 25).

- Remove the screws that secure the front flap support to the machine frame (see fig. 4.2.12-51).
- Remove the front flap support (see fig. 4.2.12-52).
- Proceed at reverse to refit the part.

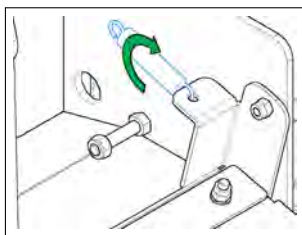

4.2.12-50

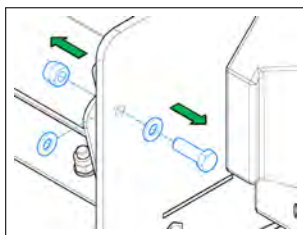

4.2.12-51

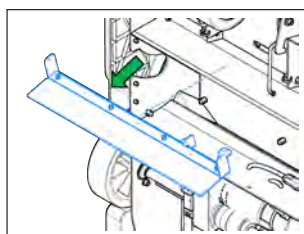

4.2.12-52

## 4.3 Side Broom System

### 4.3.1 Side Broom

- Put the machine in safe conditions.
- Make sure that the side broom is lifted.
- Unscrew the wing nut securing the brush to the support (see fig. 4.3.1-53).
- Remove the brush, paying attention to the fixing bushing.
- Proceed at reverse to refit the part.

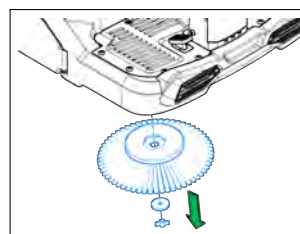

4.3.1-53

### 4.3.2 Side Broom Flange

- Put the machine in safe conditions.
- Remove the side broom (see section 4.3.1 at page 26).
- Unscrew the fixing dowel of the motor shaft (see fig. 4.3.2-54).
- Remove the flange (see fig. 4.3.2-55).
- Proceed at reverse to refit the part.

### 4.3.3 Side Broom Motor

- Put the machine in safe conditions.
- Remove the side broom (see section 4.3.1 at page 26).
- Remove the side broom flange (see section 4.3.2 at page 26).

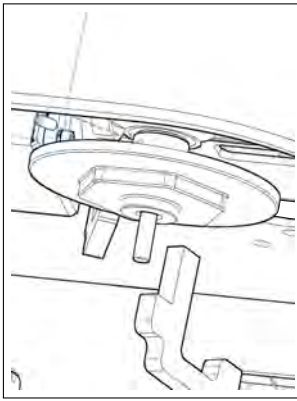

4.3.2-54

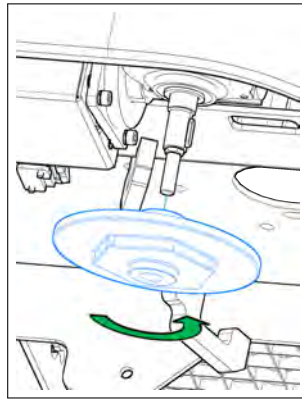

4.3.2-55

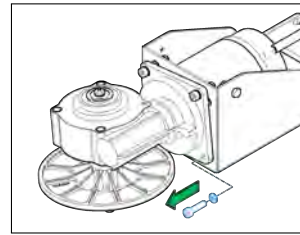

4.3.3-56

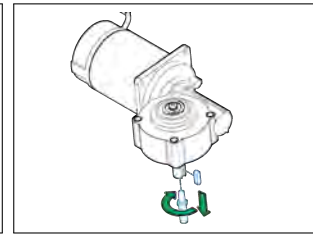

4.3.3-57

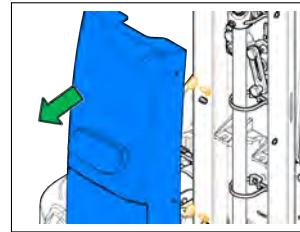

4.3.3-58

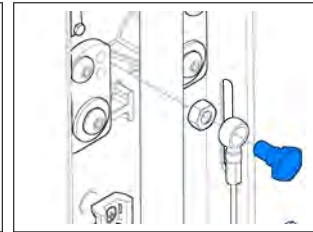

4.3.3-59

- Unplug the motor connector.
- Unscrew the screws fixing the motor to the mobile support (see fig. 4.3.3-56).
- Pull the motor to remove it.
- Remove the shaft and the key (see fig. 4.3.3-57).
- Proceed at reverse to refit the part.

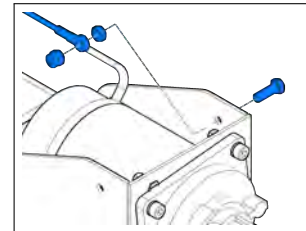

4.3.3-60

#### 4.3.4 Side Broom Lifting Wire

- Put the machine in safe conditions.
- Remove the screws that secure the front carter to the steering column (see fig. 4.3.3-58).
- Remove the screw that secures the wire to the internal lifting lever of the the side broom (see fig. 4.3.3-59).
- Loosen the screw that secures the wire to the support of the side brush motor (see fig. 4.3.3-60).
- Unscrew the nuts securing the sheath to the frame and the steering column.
- Pull the side broom lifting wire.
- Proceed at reverse to refit the part.

## 4.4 Vacuum System

### 4.4.1 Vacuum Motor

- Put the machine in safe conditions.
- Lift the upper body / seat.
- Remove the vacuum fan (see section 4.4.2 at page 28).
- Remove the vacuum motor support, by unscrewing the wing nuts (see fig. 4.4.1-61) (see fig. 4.4.1-62).
- Disconnect the motor connector.
- Unscrew the screws fixing the motor support plate to the vacuum group support plate (see fig. 4.4.1-63).
- Remove the fan hub and its key (see fig. 4.4.1-64).
- Unscrew the screws fixing the motor to the support plate (see fig. 4.4.1-65).
- Remove the motor.
- Proceed at reverse to refit the part.

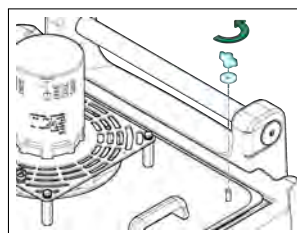

4.4.1-61

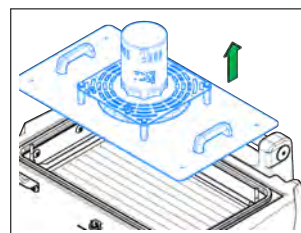

4.4.1-62

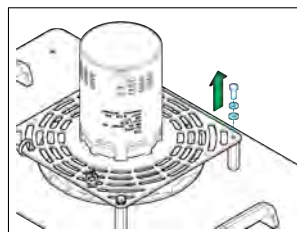

4.4.1-63

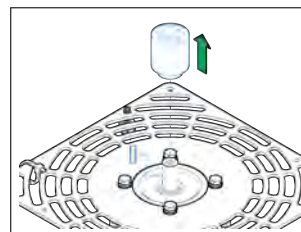

4.4.1-64

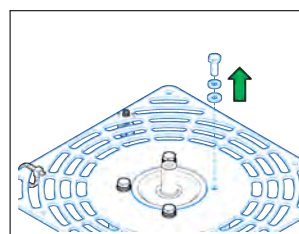

4.4.1-65

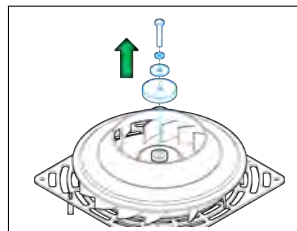

4.4.2-66

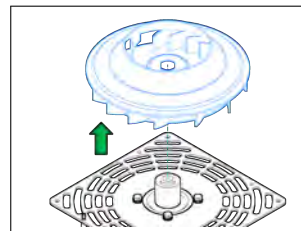

4.4.2-67

### 4.4.2 Vacuum Fan

- Put the machine in safe conditions.
- Remove the Vacuum motor (see section 4.4.1 at page 28).
- Unscrew the screw securing the Fan to the fan Hub (see fig. 4.4.2-66).
- Remove the Vacuum Fan (see fig. 4.4.2-67).
- Proceed at reverse to refit the part.

### 4.4.3 Air Filter

- Put the machine in safe conditions.
- Unscrew the wing nuts that secure the vacuum group support plate to the machine frame (see fig. 4.4.3-68) (see fig. 4.4.3-69).
- Unscrew the wing nuts of the filter locking bracket (see fig. 4.4.3-70).
- Remove the filter press bracket and then the filter (see fig. 4.4.3-71).
- Proceed at reverse to refit the part.

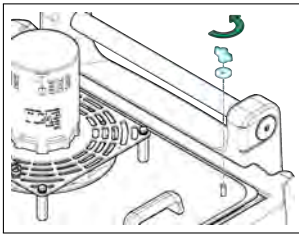

4.4.3-68

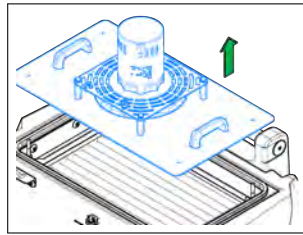

4.4.3-69

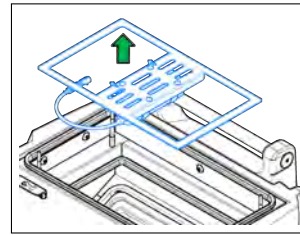

4.4.4-72

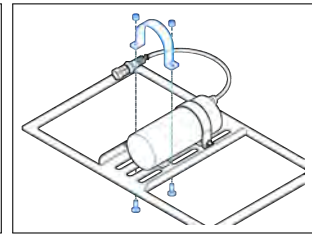

4.4.4-73

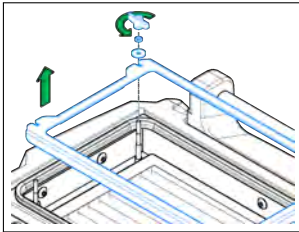

4.4.3-70

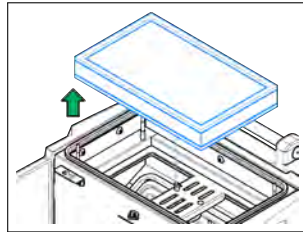

4.4.3-71

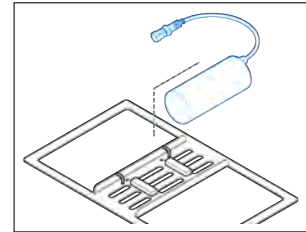

4.4.4-74

#### 4.4.4 Filter shaker

- Put the machine in safe conditions.
- Remove the air filter (see section 4.4.3 at page 28).
- Remove the filter shaker support (see fig. 4.4.4-72).
- Disconnect the filter shaker connector.
- Unscrew the screws securing the filter shaker to its support (see fig. 4.4.4-73).
- Remove the filter shaker (see fig. 4.4.4-74).
- Proceed at reverse to refit the part.
- Remove then wheel.
- Do the same for the other wheels of the hopper.
- Proceed at reverse to refit the part.

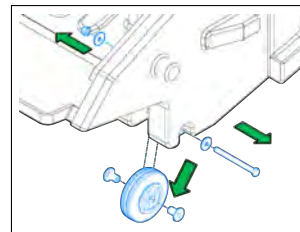

4.4.5-75

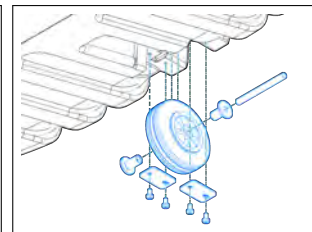

4.4.5-76

#### 4.4.5 Wheels of the Debris Hopper

- Put the machine in safe conditions.
- Remove the debris hopper from the machine.
- Remove the screw securing the wheel to the debris hopper (see fig. 4.4.5-75) (see fig. 4.4.5-76).



## 4.5 Frame and Traction System

### 4.5.1 Front Wheel

- Put the machine in safe conditions.
- Lift up the front wheel from the ground.
- Unscrew one of the fixing screws of the wheel shaft to the support (see fig. 4.5.1-77).
- Remove the wheel securing shaft to the support taking care not to lose the spacer.
- Proceed at reverse to refit the part.

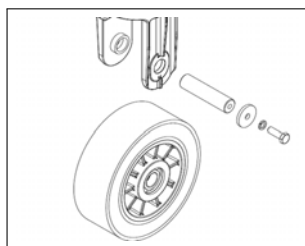

4.5.1-77

### 4.5.2 Rear Wheel

- Put the machine in safe conditions.
- Lift up the related rear wheel from the ground.
- (Only FSR B) Remove the hub cap by levering with a small flat screwdriver (see fig. 4.5.2-78).
- Loosen the fixing bolt of the wheel to the axle shaft (see fig. 4.5.2-79).
- Proceed at reverse to refit the wheel (Use the thread lock liquid on the screw during the assembling).

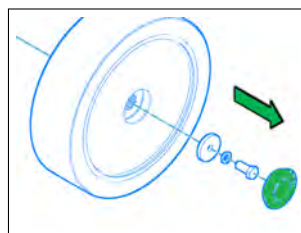

4.5.2-78

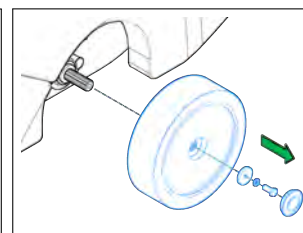

4.5.2-79

### 4.5.3 Drive shaft

- Put the machine in safe conditions.
- Remove the wheel connected to the concerned axle (see section 4.5.2 at page 30).
- Remove the flange and the bearing (see fig. 4.5.3-80).
- Remove the drive shaft from the traction motor using, if necessary, an extractor (see fig. 4.5.3-81).
- Proceed at reverse to refit the part.

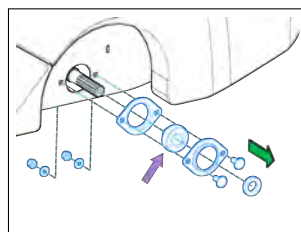

4.5.3-80

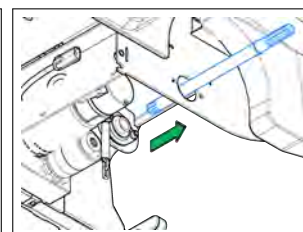

4.5.3-81

### 4.5.4 Traction Gearmotor

- Put the machine in safe conditions.
- Remove the rear wheels (see section 4.5.2 at page 30).
- Remove the drive shafts from the machine.
- Disconnect the electrical connector of the Traction Gearmotor.

- Remove the screws securing the Traction Gearmotor to the machine frame (see fig. 4.5.4-82).
- Remove the traction gearmotor.
- Remove the brackets and bearing by unscrewing the fixing screws.
- Proceed at reverse to refit the part.

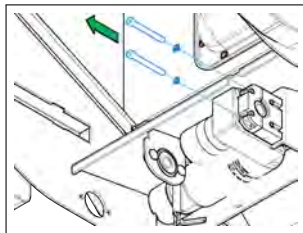

4.5.4-82

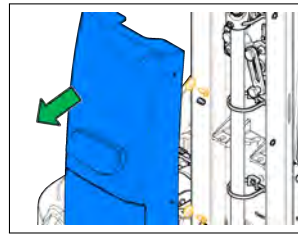

4.5.5-83

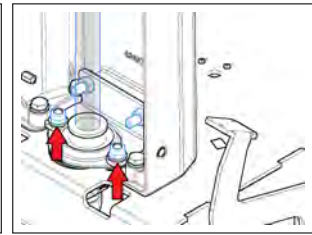

4.5.5-84

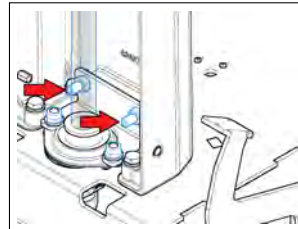

4.5.5-85

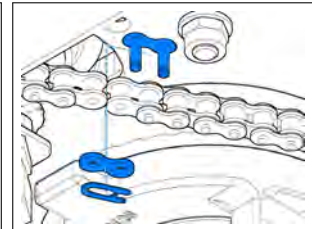

4.5.5-86

## 4.5.5 Steering Chain

- Put the machine in safe conditions.
- Remove the front carter from the steering column by loosening the screws (see fig. 4.5.5-83).
- Loosen the screws that secure the lower support of the steering shaft (see fig. 4.5.6-87).
- Loosen the chain draw dowels and the locknuts (see fig. 4.5.5-85).
- Remove the chain joint (see fig. 4.5.5-86).
- Remove the chain from the steering column.
- Proceed at reverse to refit the part.

## 4.5.6 Steering shaft

- Put the machine in safe conditions.
- Remove the front carter from the steering column by loosening the screws.

- Remove the Steering Chain (see section 4.5.5 at page 31).
- Loosen the upper dowels from the universal joint (see fig. 4.5.6-87).
- Remove the steering wheel from the machine.
- Remove the column support and the chain tensioner bracket by loosening the screws (see fig. 4.5.6-88).
- Loosen the dowels of the bearing.
- Pull out the steering column from the lower support.
- Proceed at reverse to refit the part.



4.5.6-87

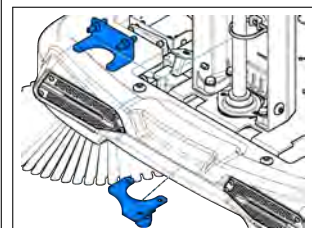

4.5.6-88

### 4.5.7 Sprocket, Support and Bearings Front Wheel

- Put the machine in safe conditions.
- Remove the footrest.
- Remove the steering chain (see section 4.5.5 at page 31).
- Lift the front wheel off the ground.
- Remove the screws securing the front wheel to the frame and remove the wheel (see fig. 4.5.7-89).
- Remove the sprocket fixing screws (see fig. 4.5.7-90).
- Remove bearing and the lever and disassemble the sprocket.
- Remove the Front Wheel (see fig. 4.5.7-91).
- Remove the bearings pin.
- Remove the bearings (see fig. 4.5.7-92) (see fig. 4.5.7-93).
- Proceed at reverse to refit the part.

**ATTENTION:** WHEN ASSEMBLING, PAY EXTREME ATTENTION AT THE CORRECT POSITIONING OF THE SPACER 436224, BECAUSE IT IS **FUNDAMENTAL** FOR THE PROPER FUNCTIONING OF THE PART.

### 4.5.8 Seat

- Put the machine in safe conditions.
- Loosen the screws securing the seat to the machine body (see fig. 4.5.8-94) (see fig. 4.5.8-95).
- Remove the seat (see fig. 4.5.8-96).
- Proceed at reverse to refit the part.

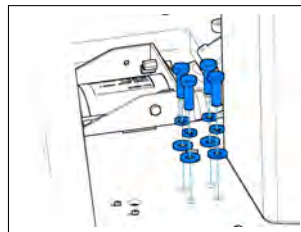

4.5.7-89

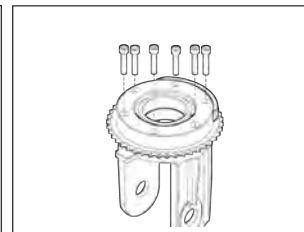

4.5.7-90

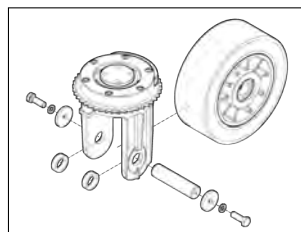

4.5.7-91

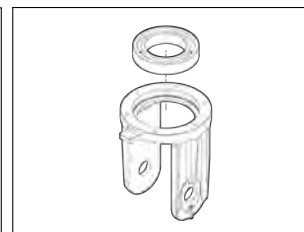

4.5.7-92

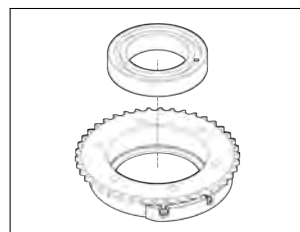

4.5.7-93

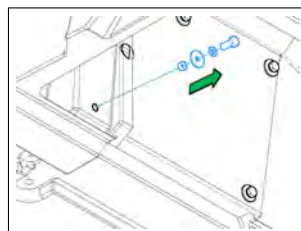

4.5.8-94

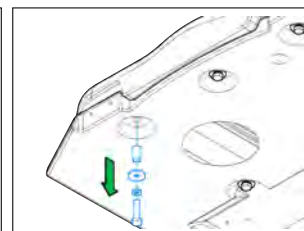

4.5.8-95

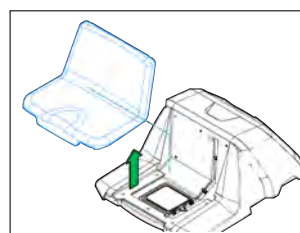

4.5.8-96



## 4.6 Endothermic Engine System

### 4.6.1 Motore Endotermico

- Put the machine in safe conditions.
- Lift the upper body / seat.
- Disconnect the machine connector (see fig. 4.6.1-97).
- Remove the right and left side grill (see fig. 4.6.1-98) (see fig. 4.6.1-99).
- Disconnect the battery loop wire (cable with 80 Amp. fuse) (see fig. 4.6.1-100).
- Remove the upper protection of the motor (see fig. 4.6.1-101).
- Remove the debris Hopper.
- Remove the cover alternator cover, unscrewing the screws (see fig. 4.6.1-102).
- Disconnect the alternator cable.
- Disconnect the ground wire from the motor.
- Disconnect the connection cables of the motor.
- Remove the air conveyor of the motor by unscrewing the screws.
- Remove the exhaust pipe of the engine by unscrewing the fixing screws (see fig. 4.6.1-103).
- ATTENTION. Once you remove the exhaust pipe, be sure to plug the hole on the motor to prevent impurities from entering the motor itself, risking to damage it.
- Remove the screws securing the motor to the machine frame (see fig. 4.6.1-104).
- Lift the motor, tilting toward the rear of the machine.

- Proceed at reverse to refit the part.



4.6.1-97



4.6.1-98



4.6.1-99



4.6.1-100



4.6.1-101



4.6.1-102



4.6.1-103



4.6.1-104

### 4.6.2 Alternator

- Put the machine in safe conditions.
- Remove the alternator cover, unscrewing the screws (see fig. 4.6.2-105).
- Disconnect the alternator cables (see fig. 4.6.2-106).
- Remove the screws securing the alternator to the motor (see fig. 4.6.2-107).

- Remove the screw securing the belt tensioner to the alternator (see fig. 4.6.2-108).
- Remove the belt of the alternator.
- Proceed at reverse to refit the part.



4.6.2-105



4.6.2-106



4.6.2-107



4.6.2-108

### 4.6.3 Silent Block

- Put the machine in safe conditions.
- Remove the motor (see section 4.6.1 at page 33).
- Remove the screws securing the silent block to the motor support.
- Proceed at reverse to refit the part.

### 4.6.4 Air Filter

- Put the machine in safe conditions.
- Remove the filter protective cover (see fig. 4.6.4-109).
- Remove the air filter (see fig. 4.6.4-110).
- Proceed at reverse to refit the part.



4.6.4-109



4.6.4-110

# Part III

## Machine Description

# Chapter 5

5-36

## Electrical System

The FSR sweeper is available in two versions, FSR B and FSR Hybrid. Both versions are equipped with a main card that controls all functions and the power output. FSR B model is battery powered while the Hybrid version offers a combined gasoline motor and battery power supply.

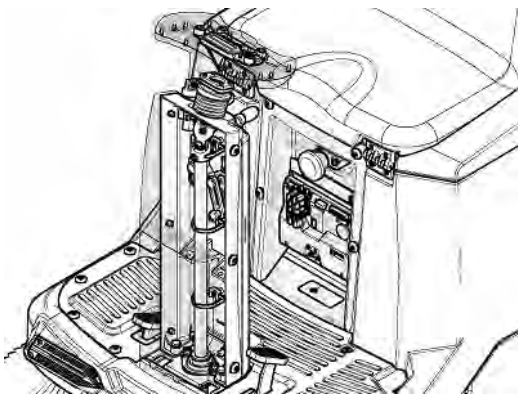

Figure 5.1: Electrical System FSR B



Figure 5.2: Electrical System FSR Hybrid

### 5.1 Structure

1. Main Card
2. Control Card
3. Microswitches: main broom motor, side broom motor, vacuum motor, curve speed reduction and deadman seat
4. Electrobrake
5. Emergency button
6. attery charger (FSR B only)
7. Traction Pedal
8. Batteries

## 5.2 Description

**A main card** runs all the functions of the machine, sweep, vacuum, traction and filtershake.

**The main card** receive as input, all the information from the control card, the deadman microswitch, the curve speed reduction microswitch, the brooms control microswitch, and all the electronic devices of the machine.

**These signals** are translated from the main card to run correctly the scrubber dryer and to prevent any safety problem to the operator.

**The dash board** can be used also as a programmer console to modify the parameter of all the machine's functions (traction, sweeping and vacuum) and, also, to check the consumption of all the motors and batteries.

## 5.2.1 Location of Electrical components FSR B

5-38

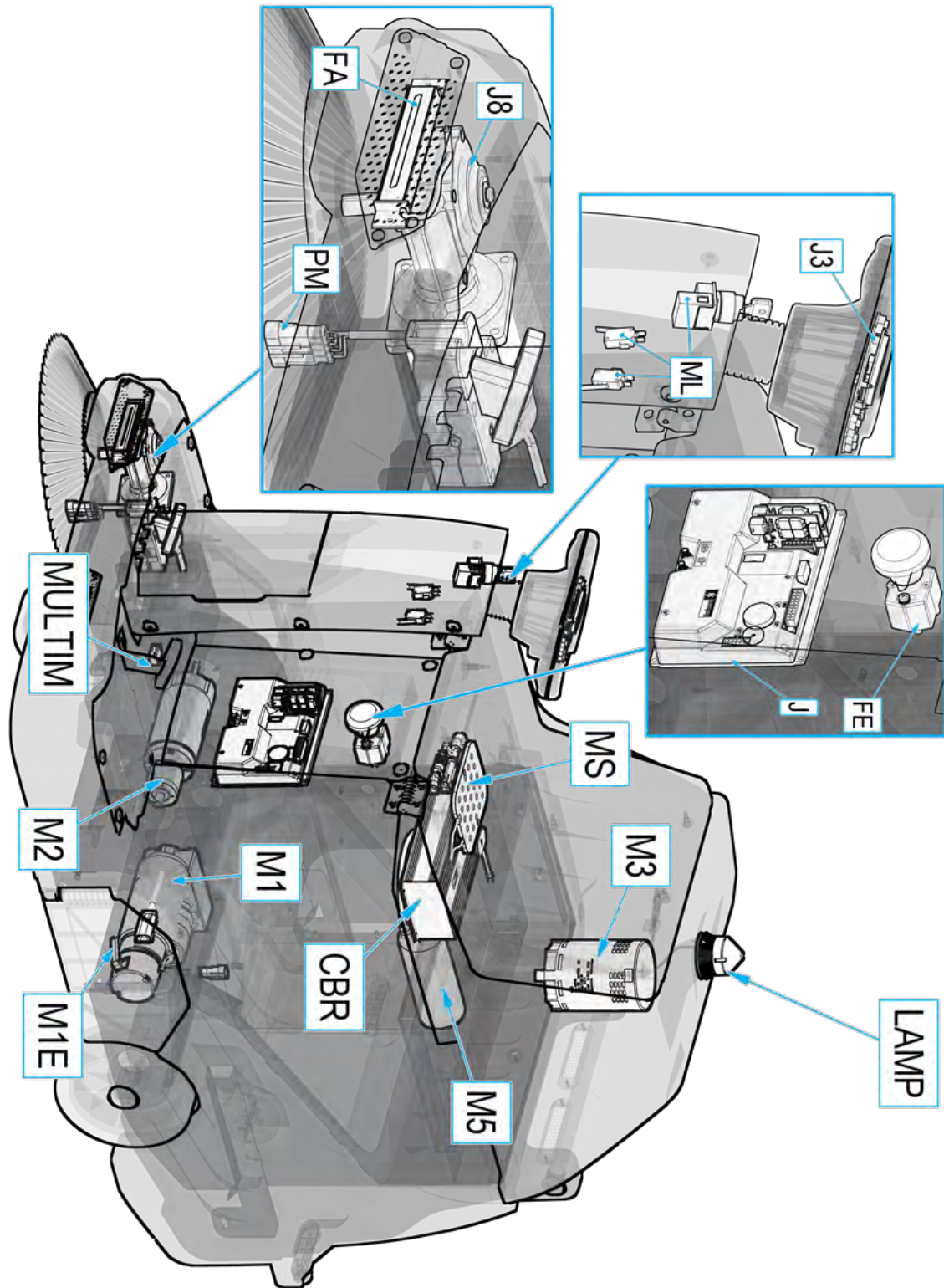



## List of Components

CBR Battery charger<sup>1</sup>

J3 Control Card

J Main Card

FE Emergency button

LAMP Safety blinking light

M1 Traction Motor

M1E Traction Motor electrobrake

M2 Main Broom Motor

M3 Vacuum Motor

ML Control microswitches

MS Seat microswitch

MULTIM Curve sensor microswitch

PM Potentiometer and pedal microswitch

M5 Filter Shaker Motor

FA Headlights

J8 Right/Left Side Broom Motor

---

<sup>1</sup>Optional

## 5.2.2 Location of Electrical components FSR Hybrid

5-40

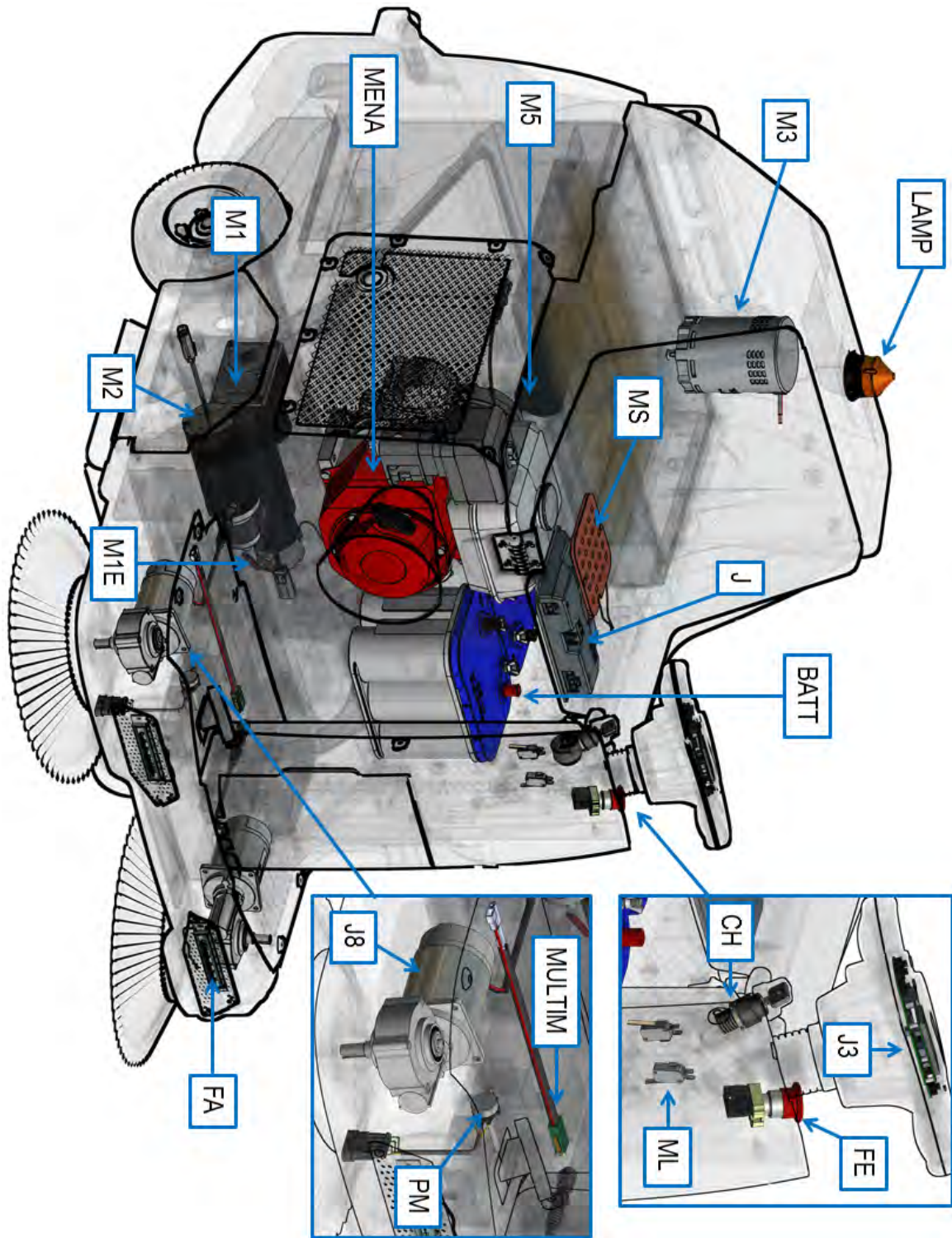



## List of Components

J3 Control Card

J Main Card

FE Emergency button

LAMP Safety blinking light

M1 Traction Motor

M1E Traction Motor electrobrake

M2 Main Broom Motor

M3 Vacuum Motor

ML Control microswitches

MS Seat microswitch

MULTIM Curve sensor microswitch

PM Potentiometer and pedal microswitch

M5 Filter Shaker Motor

FA Headlights

J8 Right/Left Side Broom Motor

CH General Key Switch

MENA Endothermic Motor and Alternator

BATT Rechargeable Batteries

### 5.2.3 Main Card

The Main Card is the heart of the machine and, depending of the input information, decides how to use the devices of the machine during normal work. On the table here below, is possible to identify the input/output signals of the card.

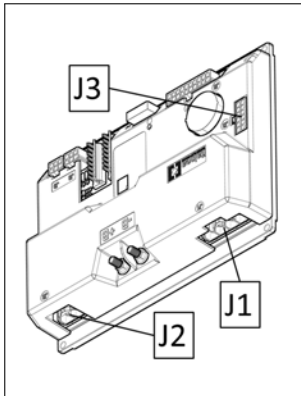

5.2.3-1

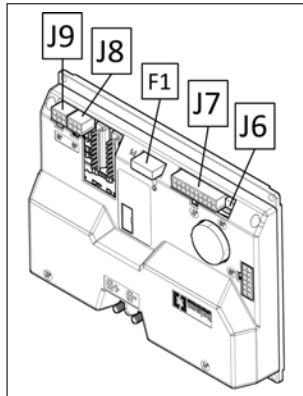

5.2.3-2

---

Input & Output Signals

---

F1	Key general fuse (3A).
J1	Vacuum motor and Main Broom motor.
J2	Traction motor.
J3	Electrobrake, blinking light, Headlights, filter shaker.
J6	Dashboard control buttons.
J7	Limit switch: Broom motor, vacuum motor, curve speed reduction, dead-man switch, traction control, battery charger (FSR B), alternator (FSR Hybrid), potentiometer.
J8	Right side broom Motor.
J9	Optional left side broom Motor.

---

### 5.2.4 Dashboard and Control card

Functions of Dashboard:

- Manage and set up the main functions and command of the machine during the normal work.
- Check the alarm code in order to detect a possible malfunction.
- Enter in three different menu:
  - The **“user menu”** to check the status of the batteries and the hourmeter of the machine (depending of the set up into “user menu”). If a defect is detected on the machine, this menu show a short message concerning the alarm.
  - The **“operator menu”** containing the basic adjustment, accessible by the user of the machine.
  - The **“advanced menu”** where is possible to modify the set up of the machine by expert technicians.

**ATTENTION:** THE **“OPERATOR MENU”** IS ACCESSIBLE WITHOUT ANY RESTRICTION, WHEREAS TO ENTER INTO THE **“ADVANCED MENU”** A PASSWORD IS NEEDED.

## Functions and Commands

During the normal working, the display shows the hourmeter and the battery control card (in percentage). When the charge of the batteries goes down to a fixed value, the battery control card disable the brush motor and, after that, the vacuum motor; in particular, the battery control card disable the brush motor (vacuum motor and traction motor still work) when the remaining charge of the batteries are 20% and disable also the vacuum motor when the remains charge of the batteries are 10%.

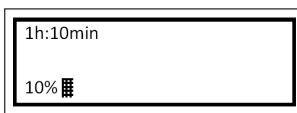

5.2.4-3

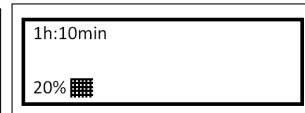

5.2.4-4

## Entry into “Operator Menu” and “Advanced Menu”

The dashboard could be used like a programming console. If you press a determinate combination of buttons you can enter into two menu:

- “Operator Menu”.
- “Advanced Menu”.

The structure of the menu can be shown in the section (see section 5.6.1 at page 53):

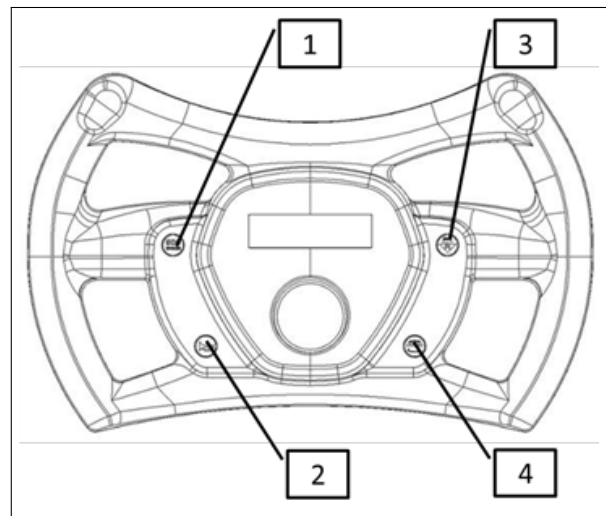

---

### Function of the buttons

---

- |   |  |
|---|--|
| 1 | Not Used                                     |
| 2 | ENTER (Confirm)                              |
| 3 | SCROLL UP/PLUS (Scroll up and Increase)      |
| 4 | SCROLL DOWN/MINUS (Scroll down and Decrease) |
-

## Operator Menu

To enter to the *Operator menu* go ahead as follow:

- With the machine off, press in the same time button “2”, “3” and “4”.
- Turn on the key, with the three buttons pressed.
- Waiting the upload of the “working menu”.
- Release the buttons.

To move inside of the menu, press the button “3” and the button “4”.

To modify a parameter or confirm a changed value, press the button “2”.

### Change a Parameter (in the Operator Menu)

To change a parameter proceed as follows:

- Run the menu with the button “3” or “4” and select the parameter to change.
- Select the submenu to be changed pressing the button “2”.
- Utilize the button “3” and “4”, to shift all the available values for the parameter necessary to modify.
- To confirm the new value press the button “2”.
- To save the change is necessary to return to the user menu; to exit from “working menu” select the menu “exit”.

For example, to modify the language from EN to IT

- Turn OFF the machine.
- Press in the same time, the buttons “2”, “3” and “4”.

- Until the buttons are pressed, turn ON the key and wait the upload of the “working menu”.
- Use the buttons “3” or “4” to select the submenu “language”.
- To modify the parameters of this menu, press the button “2”. To confirm the possibility to change parameters, the first line on the display will blink.
- Utilize buttons “3” or “4” to shift all the values on this menu and select the value “IT”.
- Confirm the new value by pressing the button “2”.
- To save this modification, select the submenu “exit” and confirm by pressing button “2”.

## Advanced Menu

The *Advanced Menu* can be reached from the “operator menu” by accessing the “password” parameter and setting the value **60**.

### Change a Parameter (in the Advanced Menu)

To change the value of a parameter, proceed as follows:

- Scroll through the submenus with the buttons “3” and “4”.
- Select the submenu that contains the parameters to be changed using the button “2”.
- Scroll through the parameters with the buttons “3” and “4” to find the parameter to be edited.
- Select the parameter with the button “2”.
- Use the buttons “3” and “4” to scroll through the list of available values of the parameter.
- Confirm the new value of the parameter using the button “2”.
- To enable the changes, it is necessary to return to the “menu work”; to exit the parameters and return to the “Advanced Menu” press simultaneously the buttons “3” and “4”, then find the sub-menu “Exit” and confirm with button “2”.

## Check/Monitor Function

It is possible to view all the values of the Check/monitor function during the normal work of the machine. To view the values, following the instruction:

- Turn OFF the machine.
- Press in the same time, the buttons “2”, “3” and “4”.
- Until the buttons are pressed, turn ON the key and wait the upload of the “working menu”.
- Use the buttons “3” or “4” to select the submenu “password”.
- Confirm pressing button “2”.
- Press button “3” or “4” until to select the password “60”.
- Confirm the password by pressing the button “2” to enter into the “advanced menu”.
- Press the button “3” or “4” to select the menu “Check/Monitor”.
- Confirm by pressing the button “2”.
- Press the button “3” or “4” to select the parameter you want to check during normal work.
- Press the button “2” to confirm.
- After confirmed, the display will return to normal view, but instead of the battery control card it will be displayed the value of the selected parameter.
- By pressing the button “2” it is possible to check the parameters of the Check/Monitor submenu.
- To exit form the “Check/Monitor” view, turn OFF and ON the machine.

### 5.2.5 Control Card

The Control Card is located inside of the steering wheel and transfers all the information and settings to the Main Card. The Control Card is linked to the Main Card by a connecting cable (item J6).

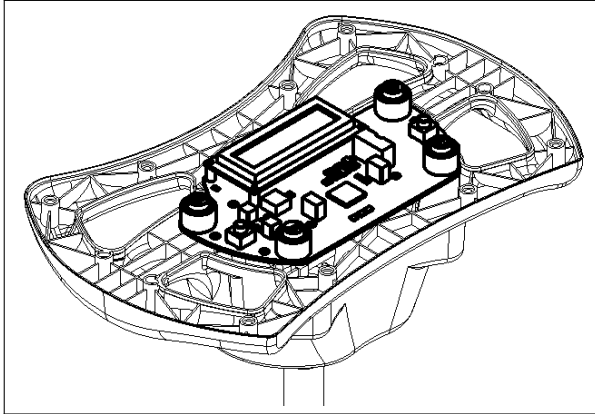

### 5.2.6 Microswitches

The machine is provided with a series of microswitches that send signals to the main card. In particular:

- Main broom and vacuum motor Microswitch. With lowered main broom lifting lever and closed micro, the deck goes down to the floor and, the broom motor and the vacuum motor, starts running (as long as the traction pedal is pressed and the operator is seated). The sweeping and vacuum function is active.

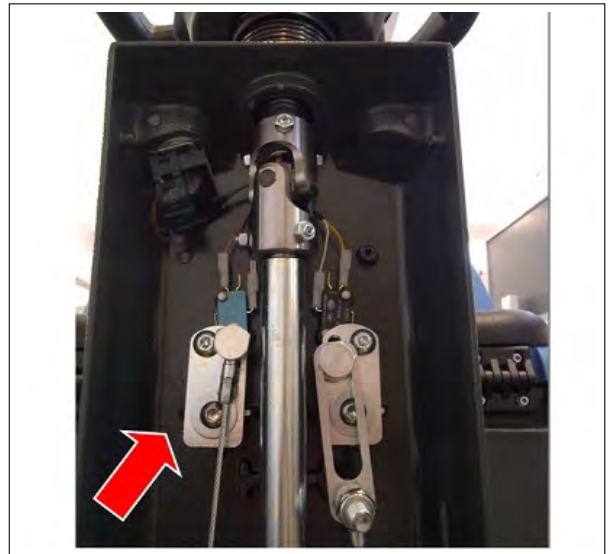

- Side broom motor Microswitch. Lowering the side broom lifting lever, and closed micro, the broom support goes down to the floor and the broom motor starts running (as long as the traction pedal is pressed, the main broom is lowered and the operator is seated).



In the case of double side brush, the process does not change.

- Curve speed reduction Microswitch. it is positioned below the platform, tangent to a cam. After a predetermined angle of rotation of the steering, the microswitch opens and the curve speed reduction function is activated. The percentage of the speed reduction is an adjustable parameter.

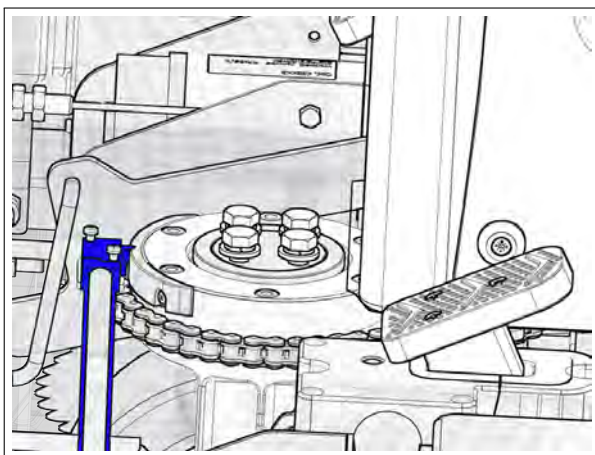

- Deadman Microswitch. The micro switch is located below the seat. With the operator on board, the traction and the brush deck can be activated.

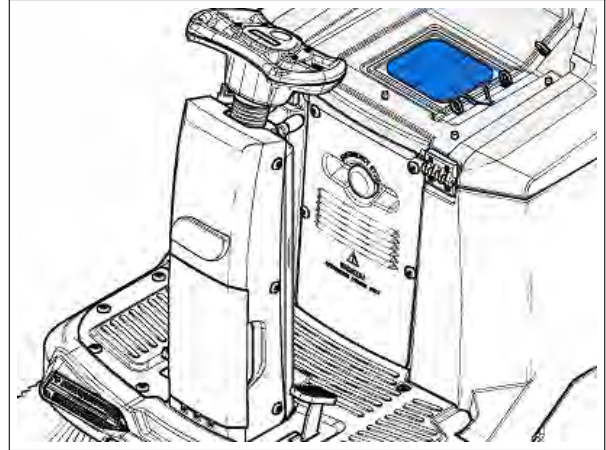

### 5.2.7 Electrobrake

The machine is equipped with electro-brake. The electro-brake is engageable through an appropriate control lever positioned on the electro-brake itself, close to the traction motor. Looking at a global security condition, even if the machine is switched off and the electrobrake is disengaged, the electrobrake blocks however, in case of exceeding a certain speed (when pushing the machine or if the machine is on an inclined floor). If the machine is switched on, the drive is inhibited if the electrobrake is disengaged.





### 5.2.8 Emergency button

The machine is equipped with an emergency button, aimed at the protection of the operator in case of sudden critical conditions. A press of the button switches off the power to the Main card and the machine stops immediately.

**FSR B:** the button is located on the electrical system cover.



**FSR Hybrid:** the button is located on the steering wheel column.



### 5.2.9 Traction Pedal

The traction pedal have an internal microswitch that closes when the pedal is pressed and a potentiometer to adjust the intensity of the traction speed.

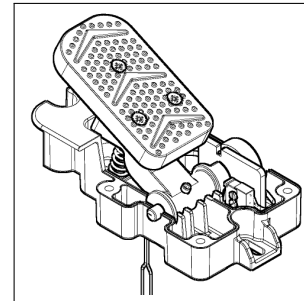

5.2.9-5

### 5.2.10 Battery charger

The machine with Battery power supply is available with the optional battery charger. To get access to the battery charger and the battery compartment is enough to lift the seat. On the batteries there is a loop wire with 80 Ampere general protection fuse.

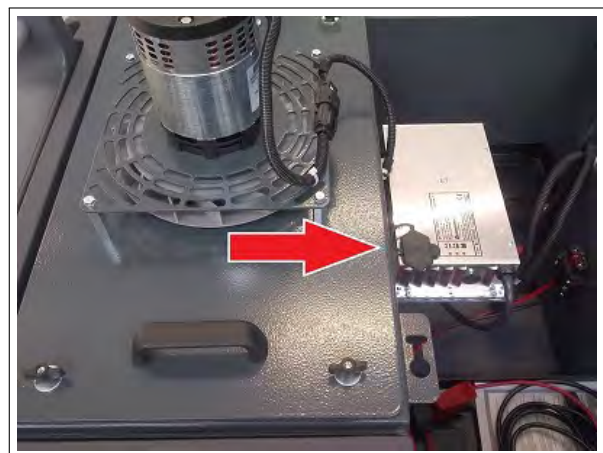



## 5.3 Adjustments

### 5.3.1 Traction Pedal

The microswitch and the potentiometer inside the traction pedal are properly adjusted during assembly of the pedal.

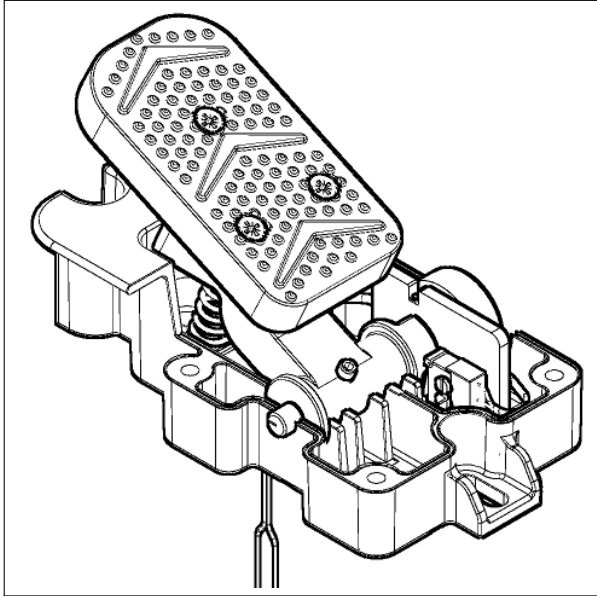

If it is necessary to calibrate the potentiometer remove the platform, release the control connector and pull the pedal out by unscrewing the two screws.

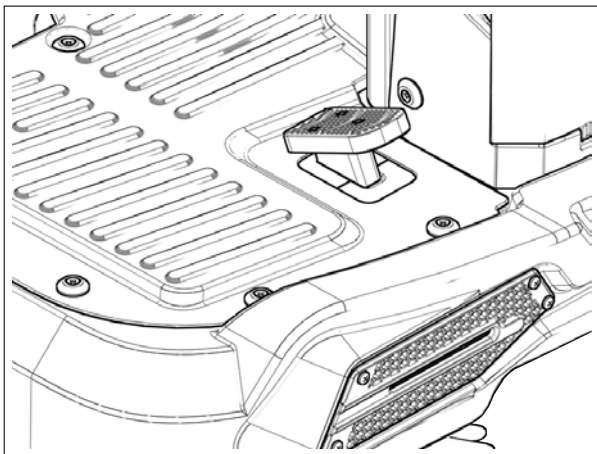

Procedure:

- Remove the plastic cap and loosen the adjustment dowel.
- Rotate the pedal lateral spindle clockwise, until it is in the zero position.

- Using the tester to measure the resistance ( $\Omega$ ) place the tester terminals corresponding to the green and yellow wires and check the resistance value to be approximately zero  $\Omega$ .
- Turn the potentiometer shaft counterclockwise until the tester gives  $0,5 \Omega (\pm 0,1)$ .
- Lock the dowel and replace the plastic cap.
- Reinstall the pedal and the footrest.

### 5.3.2 Microswitch

Check functionality and conditions of the vacuum/main broom microswitch, the side broom microswitch, and the curve speed reduction microswitch. Check that with microswitch pressed, remain about 0.5 mm clearance between the lever and the body of the device. Make sure the lever of the micro is working properly. Otherwise, proceed as follows:

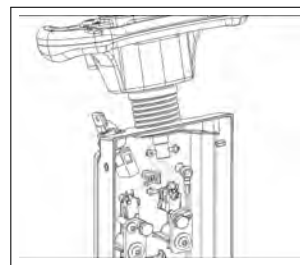

5.3.2-6

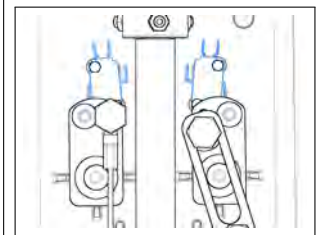

5.3.2-7

- Unscrew the fixing screws.
- Move the DIP switches using the loop adjustment.
- Fix the screws to lock the microswitches taking care not to over tighten in order not to ruin the devices.

- When the setting is finished, verify the correct functionality of the microswitches.

### 5.3.3 Battery Charger (FSR B)

The battery charger is positioned behind the operator’s seat and is easily accessible by pressing the release button on the recovery tank. When connected to the power supply, a red led will blink once, the yellow led blink once and the green led blink depending of the type of battery for which the charger is set. A Proper Charging cycle follows the below phases order.

Phase	LED	Description
A	Red	Blinking, check of battery status
B	Red	First charging phase
C	Yellow	Second charging phase
D	Green	Charged battery

Check if the charger is properly set according to the installed batteries.

#### Charging curve SetUp

To set up the charger, follow the instructions:

- Use a screwdriver to remove the small black plastic cap
- Set-up the internal dipswitches according to the following table

The dipswitches are divided in two couple. The higher couple are the dipswitches 1 and 2, the couple down are the dipswitches 3 and 4. The following table shows how to setup the dipswitches 1 and 2.

DP3: OFF (not used)

DP4: OFF (not used)

Restore the the small black plastic cap.

Set-up of Charging Curve			
DP1	DP2	Set Up	Flash
OFF	OFF	Wet cell batteries	1
ON	ON	Gel TROJAN	2
OFF	ON	Generic GEL or AGM batteries	3
ON	OFF	Gel EXIDE SON-NENSCHHEIN	4

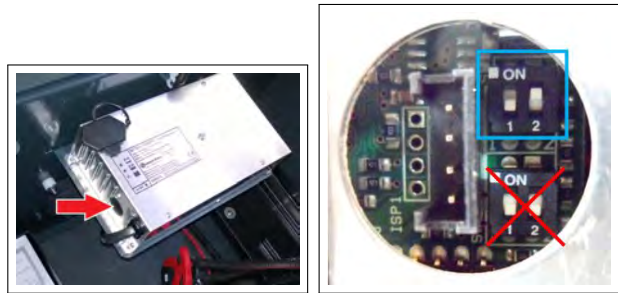

5.3.3-8

5.3.3-9

#### Error Codes of Charger

The charger have an alarm system. The alarm code is shown by blinks of the yellow led.

Error code	
Flash	Description
1	Wrong battery, Inverted polarity, short circuit to the exit
2	Timeout alarm, Defect of the battery
3	Defect of the Charger
4	Overtemperature alarm

## 5.4 Maintenance and Checks

### 5.4.1 Electrical System

**Check** (to perform every **150h**)

Check the functions and the proper connections of the switches, microswitches, motors, power fuses, battery loop wires and emergency button. Check periodically, the wiring connections status. To get access to the electrical system:

**FSR B:** remove the carter sited near the emergency button. **FSR Hybrid:** Lift the upper body/seat.

### 5.4.2 Emergency Button

**Check** (to perform every **150h**)

Check the correct functionality of the emergency button. Once pressed, the machine must stop immediately.

### 5.4.3 Electrobrake

**Check** (to perform every **150h**)

Check the functionality of the electrobrake.

With control lever rotated downward (electrobrake engaged), if you try to push the machine, it must be locked (regardless of whether the machine is powered or not).

With control lever rotated upward (electrobrake released), the machine must be free to move when pushed, regardless of whether the machine is powered or not.

With the machine powered up, if you try to work the drive must be inhibited. The display on the steering wheel has to show the alarm related to the electrobrake not engaged.



### 5.4.4 Batteries

**Check** (to perform every **150h**)

Check the proper connection of the Loop wire with 80 Ampere general fuse.



5.4.4-10 FSR B



5.4.4-11 FSR Hybrid

## 5.5 Alarm Table

### 5.5.1 Alarms

#### Alarms of Overcurrent and Temperature

Id Alarm	Meaning	Solution
AL_1: Function Brushes Ammeter	Brush Amperometric Protection	Check consumption of the brush motor. Detected high current on brush motor.
AL_2: Function Vacuum Ammeter	Vacuum Amperometric Protection	Check consumption of the vacuum motor. Detected high current on vacuum motor.
AL_3: Function Powerstage fail	Damage of Power	Damage power of brush or vacuum: replace the main card. This alarm could be shown also during the trailing of the machine.
AL_4: Function Overcurrent	Output overcurrent on brush or vacuum	Detect a shortcircuit on output brush motor or vacuum motor: Check connections and motors.
AL_5: Function Overtemperature	Thermal protection on brush/vacuum	Overtemperature of brush/vacuum motor: check consumption of motors.

#### Traction Alarms

Id Alarm	Meaning	Solution
AL_13: Traction Pedal failure	Pedal anomaly	Check the connections and the condition of the pedal potentiometer.
AL_14: Traction Release Pedal	Pedal pressed before starting	Detected pedal microswitch pressed before starting: release the pedal.
AL_15: Traction Overtemperature	Thermal protection on traction	Overtemperature on traction : check consumption of traction motor
AL_16: Traction Powerstage fail	Power of traction damage	Replace the main card.
AL_17: Traction Overcurrent	Traction Overcurrent	Detected a shortcircuit on the traction motor output: Check connections and status of the traction motor.
AL_18: Traction Traction Ammeter	Traction Amperometric protection	Check how the traction function is used. Detected too high working current on traction motor.
AL_19: Traction Electrobrake	Electrobrake not inserted	Check the condition of the electrobrake and its related microswitch.

#### General Alarms

Id Alarm	Meaning	Solution
AL_20: General EEPROM FAIL	Error reading internal memory	Replace the main card.
AL_21: General KEY-OFF FAILURE	Error key sequence	Error on key signal: Check the key connection. Check, also, the batteries connections and main card
AL_22: General Main relay fail	Damage of general relay	Check the traction motor connections. If the connection are OK, the general relay on the main card is damaged: replace the main card.
AL_23: General Overvoltage	Overvoltage	Detected a overvoltage on the main card. Check the batteries connections.
AL_24: Traction Batt.connection	Battery not connected to the main card	Check the traction motor, Detected high voltage on traction motor.
AL_25: General Keyboard com.	No communication between control card and main card	Check the connections between control card and main card.

## 5.6 Menu tables

### 5.6.1 Menu scheme

- Make sure the machine is turned off.
- Press simultaneously the buttons 2,3,4.
- Turn on the machine while holding down the buttons.
- Wait the loading of the Operator Menu.

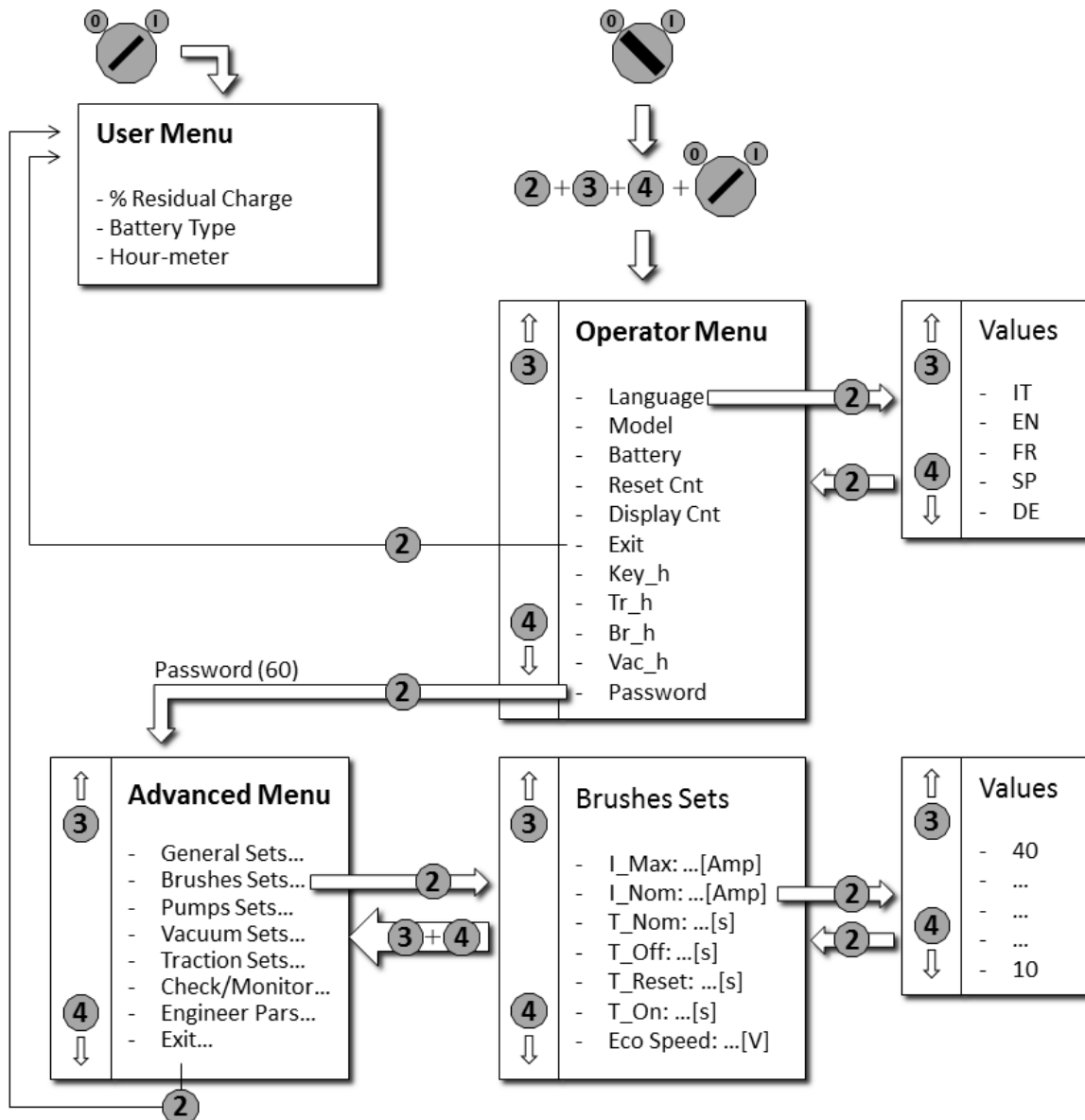

- For the submenus of the Advanced Menu, refer to the specific tables.

## 5.6.2 Working Menu

MENU	DEFAULT	CHOICES	DESCRIPTION
General Setup: Language: ##	IT	IT - EN - FR - SP - DE	Setup language
General Setup: Mod: #####	FSR	...	Setup type of machine
General Setup: Battery: ###	GEL	GEL - WET - AGM - GE1 - WE1	Setup kind of battery
General Setup: Reset Cnt: #	N		Reset partial hourmeter.
General Setup: Display Cnt: ###	TR	KEY - TR	Select the kind of hourmeter: <b>key</b> connect to the key - <b>tr.</b> connect to the traction motor
General Setup: Exit: .....	N		Exit from the menu.
General Setup: Key.h: #### h:## m			Total hourmeter connect to the key.
General Setup: Tr.h: #### h:## m			Total hourmeter connect to the traction.
General Setup: Br.h: #### h:## m			Total hourmeter connect to the brush motor.
General Setup: Vac.h: #### h:## m			Total hourmeter connect to the vacuum motor.
General Setup: password: ###	60		This password is necessary to enter into the "Advanced menu", utilized by expert technicians only.

## 5.6.3 Advanced Menu

MENU	DESCRIPTION
Options menu: General sets.	Enter to the general parameters (language, battery...).
Options menu: Brushes sets.	Enter to the parameters for the brush base.
Options menu: Pumps sets.	Parameter not managed.
Options menu: Vacuum sets.	Enter to the parameters of vacuum motor.
Options menu: Traction sets.	Enter to the parameters of traction motors.
Options menu: Check/Monitor.	Enter to view the list of working parameters.
Options menu: Engineer pars.	Protected parameters (calibrations and factory settings).
Options menu: Exit: ....	Exit and return to the main menu.

## General Sets

MENU	DEFAULT	VALUES	DESCRIPTION
General Sets: Language: ##	IT	IT - EN - FR - SP - DE	Setup the language of the display.
General Sets: Mod: ###	FSR	...	Setup of the machine model.
General Sets: Battery: ###	GEL	GEL - WET - AGM - GE1 - WE1	Setup of the battery type.
General Sets: Rst.Cnthr: #	N		Reset partial hourmeter (like on "working menu").
General Sets: Rst.Main Cnthr:	N		Reset total hourmeter (key, brush, vacuum, traction).

## Brushes Sets

Parameter	Default	Min ÷ Max	Description
Brushes Sets: I. Max: ## [Amp]	50	20 ÷ 80	Maximum current from the main card to the brush motor.
Brushes Sets: I. Nom: ## [Amp]	22	10 ÷ 40	Rated current; with T. Nom manages the amperometric protection (alarm + stop brush motor).
Brushes Sets: T. Nom: ## [s]	30	1 ÷ 60	Rated timer; with I. Nom manages the amperometric protection (alarm + stop brush motor).
Brushes Sets: T. Off: ### [s]	0,2	0,0 ÷ 10,0	Delay of switching off of the brush motor when the safety lever is released.
Brushes Sets: T. Reset: ## [s]	10	0 ÷ 100	Timing of reset amperometric protection (overcurrent).
Brushes Sets: T. On: ### [s]	0,5	0,0 ÷ 5,0	Delay to switching on of the brush motor when the safety lever is pressed.
Brushes Sets: Eco speed: ## [V]	17	15 ÷ 20	Parameter not managed.

## Pumps Sets

Parameter not managed



## Vacuum Sets

Parameter	Default	Min ÷ Max	Description
Vacuum Sets: I. Max: ## [Amp]	40	10 ÷ 50	Maximum current from the main card to the vacuum motor.
Vacuum Sets: I. Nom: ## [Amp]	18	5 ÷ 20	Rated current; with T. Nom manages the amperometric protection (alarm + stop vacuum motor).
Vacuum Sets: T. Nom: ## [s]	30	1 ÷ 100	Rated timer; with I. Nom manage the amperometric protection (alarm + stop vacuum motor).
Vacuum Sets: T. Off: ### [s]	0	0 ÷ 30	Delay of switching OFF of the vacuum motor when the pedal is released.
Vacuum Sets: T. reset: ## [s]	60	0 ÷ 100	Timing of reset amperometric protection (overcurrent).
Vacuum Sets: Eco Speed: ## [V]	17	15 ÷ 20	Parameter not managed.

## Traction Sets

Parameter	Default	Min ÷ Max	Description
Traction Sets: Acc. Ramp: ### [s]	3.0	0.5 ÷ 5.0	Acceleration ramp. The time necessary to arrive at the maximum speed.
Traction Sets: Dec. Ramp: ### [s]	0.7	0.5 ÷ 5.0	Deceleration ramp. The time necessary to stop the machine when the safety lever is released.
Traction Sets: Rev. Ramp: ### [s]	0.7	0.5 ÷ 5.0	The time necessary to invert the way.
Traction Sets: FW. Speed: ### [%]	100	20 ÷ 100	Maximum speed in forward way (expressed in %).
Traction Sets: BW. Speed: ### [%]	60	20 ÷ 100	Maximum speed in reverse way (expressed in % respect the maximum speed in forward way).
Traction Sets: Min. Speed: ### [%]	0	0 ÷ 20	Minimum speed when the safety lever is pressed.
Traction Sets: Ref. 0: ## [V]	0.7	0.0 ÷ 15.0	Minimum voltage of the potentiometer when released.
Traction Sets: Ref. FW: ## [V]	0.9	0.5 ÷ 15.0	Maximum voltage of the potentiometer in forward speed when safety lever is pressed.
Traction Sets: Ref. BW: ## [V]	0.9	0.5 ÷ 15.0	Maximum voltage of the potentiometer in backward speed when safety lever is pressed.
Traction Sets: Ref. DB: ##### [V]	0.200	0 ÷ 0.500	Potentiometer dead band.
Traction Sets: Brake. Del: ### [S]	1.5	0.0 ÷ 10	Engaging time of electronic brake when the machine is stopped.
Traction Sets: Model V: ## [%]	50	10 ÷ 100	Voltage setting for the curve speed reduction microswitch.
Traction Sets: Model I: ## [A]	25	0 ÷ 90	Current intensity setting for the curve speed reduction microswitch.
Traction Sets: Runaway: ### [Volt]	12	0 ÷ 20	Parameter not managed.
Traction Sets: optional3: ##	0	0	Parameter not managed.
Traction Sets: optional2: ##	0	0	Parameter not managed.
Traction Sets: optional1: ##	0	0	Parameter not managed.
Traction Sets: I. Max: ## [Amp]	70	10 ÷ 90	Maximum output from the main card to the traction motor.
Traction Sets: I. Nom: ## [Amp]	20	5 ÷ 30	Rated Current; with T. Nom detect the amperometric protection threshold. (Alarm + stop traction motor).
Traction Sets: T. Nom: ## [s]	10	1 ÷ 30	Rated Timer; with I. Nom detect the amperometric protection threshold. (Alarm + stop traction motor).

## Check / Monitor

Check / Monitor: I. Tr: ### [Amp]	Show current of traction motor.
Check / Monitor: I. Br: ## [Amp]	Show current of central broom motor.
Check / Monitor: I. Vac: ## [Amp]	Show current of vacuum motor.
Check / Monitor: V. Tr: ##### [V]	Show voltage of traction motor.
Check / Monitor: V. Batt: ##### [V]	Show battery voltage.
Check / Monitor: Vref: ### [V]	Show the voltage reference of the traction pedal.
Check / Monitor: Wtr. Pump: ### [%]	Parameter not managed.
Check / Monitor: Det. Pump: ### [%]	Parameter not managed.
Check / Monitor: BR Temp: ## [C]	Show temperature inside of main card, related to brush/vacuum.
Check / Monitor: TR Temp: ## [C]	Show temperature inside of main card, related to traction.
Check / Monitor: TR Ovrd: ### [%]	Show the percentage value of the amperometric protection of traction motor (when 100% the amperometric protection cuts the current).

## 5.7 Technical Features

TECHNICAL DESCRIPTION	U/M	FSR B	FSR Hybrid
Dimension of Battery compartment (l x L x h)	mm	(2x) 340x175x280	(1x) 270x360x250
Batteries Rated Voltage	$\frac{V}{Ah}$	2x(12/105)	2x(12/55)
Maximum batteries weight	kg	2x36,5	2x20

## 5.8 Recommended Spare Parts

PN	Description	FSR	
		B	Hybrid
438767	MAIN CARD	✓	✓
436267	CONTROL CARD	✓	✓
222367	TRACTION PEDAL ASSEMBLY	✓	✓
409261	COMPLETE KEY SWITCH	✓	
438121	COMPLETE KEY SWITCH		✓
409499	MICROSWITCH 3X22 L.C.FLAT	✓	✓
409503	SEAT MICROSWITCH	✓	✓
216691	COMPLETE SEALED MICROSWITCH	✓	✓
436144	EMERGENCY BUTTON ED80	✓	
435489	EMERGENCY BUTTON		✓
223390	BATTERY CHARGER KIT	✓	

# Chapter 6

## Main Sweeping System

6-60

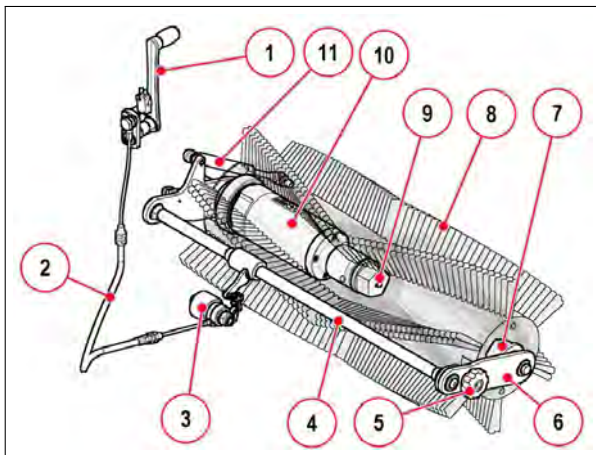

### 6.1 Structure

1. Command lever
2. Lifting wire
3. Wire guide
4. Broom support arm
5. Broom release knob
6. Broom left support
7. Broom left coupling
8. Broom
9. Broom right coupling
10. Main broom gearmotor
11. Gas spring

### 6.2 Description

**The sweeping function** of the machine is assigned to the central brush. This brush actively collects debris of medium and large dimensions and helps the vacuum system to collect dust. The brush has cusped bristles to prevent dirt from accumulating on the sides of the machine, not being collected.

**The support of the central brush** is moved by means of a steel cable directly connected to the control lever on the steering column. The steel cable and connected by a chain, to the lifting arm of the main brush.

**The rotation** of the brush is assigned to a motor with integrated gear housed in the core of the brush itself.

**There are different types** of central brush, generally when the dirt is heavy and of big size, it is recommended a hard bristle and vice versa.

Similarly, is recommended a mixed metal bristle (copper brass or similar) in the case the machine work on plastic material floors or carpet, so as to prevent the accumulation of electrostatic charges.

## 6.3 Adjustments

### 6.3.1 Lifting wire

The broom have move freely in his compartment. It has to touch the floor when it is placed in the working position (regardless of the level of wear) and must be able to be lifted without interfering with the machine frame.

**Requirements:** (New) Mounted brush, switched off machine.

**Procedure:**

- Lift the main brush by acting on the lever.
- Verify that the distance between the brush and the floor is between 15 and 20 mm.
- In case the distance is less act on the sheath nuts of the lifting wire to adjust the height.
- Once Adjusted verify the correctness and proceed to check tightness of all nuts and bolts.

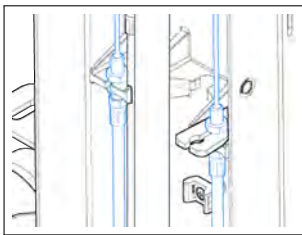

6.3.1-12 Brush lifting wire

## 6.4 Maintenance and checks

### 6.4.1 Motor

**Check** (to perform every **150h**)

The motor should rotate evenly and smoothly. It's important that the reduction case is not noisy and that the motor current consumption is not higher than the declared on the plate, regardless of the load which it is subjected. It is necessary that the motor carbon brushes are always in good condition and show no signs of abnormal wear.

**Maintenance** (to perform every **600h**)

Motor carbon brushes replacement: *Procedure:*

- Put the machine in safe conditions.
- Remove the motor from the machine (see section 4.2.3 at page 23).
- Remove the plastic covers by levering with a small screwdriver.



6.4.1-13 Hood opening

- Replace the carbon brushes being careful not to ruin them during assembly.
- Proceed to the reverse operations to reassemble it all.

## 6.4.2 Bearings

### **Check** (to perform every **150h**)

The bearings allow a fluid and little tiring rotational movement of the main broom. To prevent the main broom is locked in a position without the possibility of movement, is important that the bearings are in good condition and that the rotational movement is fluid. In case of excessive noise or difficulty in rotate, it is necessary to replace them.

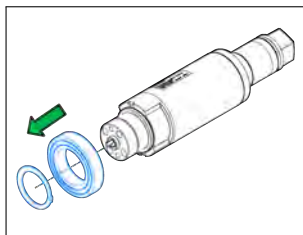

6.4.2-14 Motor bearings

## 6.4.3 Lifting mechanism

### **Check** (to perform every **150h**)

The lifting mechanism should be clean and lubricated. The lubrication of the cables must be done with silicone spray, it should not be used any grease or oil to prevent that the dirt paste itself to the classics lubricants, and lock the mechanism. The lubrication of the chain and of the lifting mechanism must be done with lubricant grease.



## 6.5 Technical Features

TECHNICAL DESCRIPTION	U/M	FSR B	FSR Hybrid
Width main broom	mm	580	580
Diameter main broom	$\phi$ mm	260	260
Main broom turns	rpm	550	550
Main broom motor voltage	V	24	24
Main broom motor power	W	380	380

## 6.6 Consumable Spare Parts

PN	Description	Width/ $\phi$ (mm)	$\phi$ Bristle (mm)	Bristle type
437902	MAIN BROOM	580 / 260	0.7/1.1	PPL/Bronze
438621	MAIN BROOM	580 / 260	0.7/1.1	Natural fibre
<b>Carbon Brushes</b>				
422462	BR.MOT.CARBON BR.	-	-	-

## 6.7 Recommended Spare Parts

PN	Description	FSR	
		B	Hybrid
437901	GEAR MOTOR 24V 380W 600RPM	✓	✓
438131	GAS SPRING	✓	✓
437879	MAIN BROOM LIFTING WIRE	✓	✓
415476	MAIN BROOM LEFT COUPLING	✓	✓
437896	MAIN BROOM RIGHT COUPLING	✓	✓

# Chapter 7

## Side Brush System

7-64

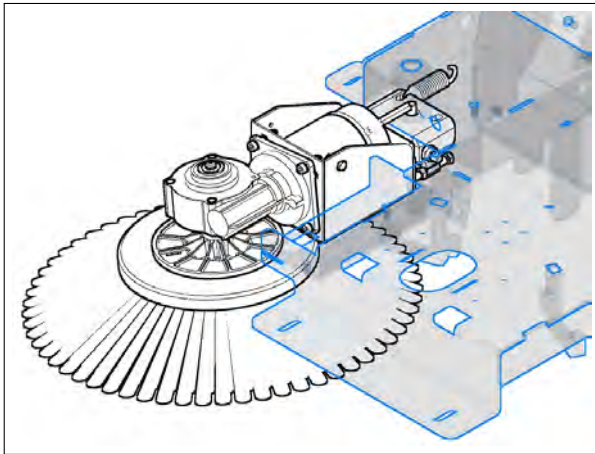

### 7.1 Structure

1. Lifting wire
2. Wire guide
3. Brush gearmotor support
4. Brush coupling flange
5. Brush
6. Side Brush gearmotor

### 7.2 Description

**FSR is equipped** with a side brush on its right side (on the left side, can also be mounted a second side brush upon request).

**This brush** is dedicated to move dirt close to the edges, due to the pedestrian areas or walls, towards the center of the machine where can be collected then by the main brush.

**For this reason** the side brush is not used in standard working conditions but only when it is necessary to clean a particular area.

## 7.3 Adjustment

### 7.3.1 Side brush support

The side brush support have to be adjusted with a new brush properly mounted. The adjustment of the support is twofold:

- Lifted position Adjustment. For a proper adjustment of the side brush in lifted position, it is necessary to act on the lifting wire.

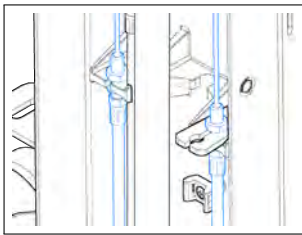

7.3.1-15 Brush lifting wire

- Lowered position Adjustment. For a proper adjustment of the side brush in lowered position, it is necessary to act on the adjusting screw.

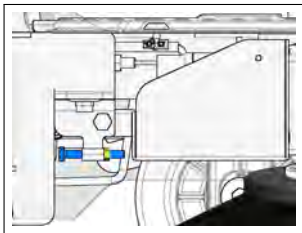

7.3.1-16 Adjusting screw

### Procedure

- Put the machine in safe conditions.
- Install a new side brush on the machine.
- Pull the brush in the lifted position through the control lever.
- Verify that in this position the side brush gearmotor rests on the machine body.
- In case it is necessary to adjust the position act on the nuts of the lifting cable sheath.
- Verify the functionality of the obtained setting.
- Lower the side brush to the floor.
- Make sure that the brush touches the ground only for 2/3 of its circumference.
- If necessary act on the end stroke screw to adjust the movement of the brush holder.

## 7.4 Maintenance and 7.4.3 Lifting mechanism checks

### 7.4.1 Side brush support

**Check** (to perform every **150h**)

In order to operate properly, the side brush support must be free to move properly. The brush must in fact be able to follow the floor and to operate freely to the ground.

**Check** (to perform every **150h**)

The lifting mechanism should be clean and lubricated. The lubrication of the cables must be done with silicone spray, it should not be used any grease or oil to prevent that the dirt paste itself to the classics lubricants, and lock the mechanism.

### 7.4.2 Side brush motor

**Check** (to perform every **150h**)

The motor should rotate evenly and smoothly. It's important that the reduction case is not noisy and that the motor current consumption is not higher than the declared on the plate, regardless of the load which it is subjected. It is necessary that the motor carbon brushes are always in good condition and show no signs of abnormal wear.

**Maintenance** (to perform every **600h**)

Motor carbon brushes replacement: *Procedure:*

- Put the machine in safe conditions.
- Remove the side brush motor from the machine (see section [4.3.3](#) at page [26](#)).
- Unscrew the screws that secure the rear hood to the motor.
- Replace the carbon brushes being careful not to ruin them during assembly.
- Proceed to the reverse operations to reassemble it all.

## 7.5 Technical Features

TECHNICAL DESCRIPTION	U/M	FSR B	FSR Hybrid
Diameter side brush	$\phi$ mm	400	400
Side brush turns	rpm	65	65
Side brush motor voltage	V	24	24
Side brush motor power	W	90	90

## 7.6 Consumable Spare Parts

PN	Description	$\phi$ (mm)	$\phi$ Bristle (mm)	Bristle type
437874	SIDE BRUSH	400	1.0	PPL
<b>Carbon Brushes</b>				
415981	BR.MOT.CARBON BR.	-	-	-

## 7.7 Recommended Spare Parts

PN	Description	FSR	
		B	Hybrid
437876	BRUSH LIFTING WIRE	✓	✓
410237	SECURING WINGNUT	✓	✓
438443	RIGHT/LEFT GEARMOTOR 90W 24V 65RPM	✓	✓

# Chapter 8

## Vacuum System

### 8.1 Structure

1. Vacuum Motor
2. Fan
3. Filter
4. Filter shaker
5. Front Flap
6. Rear Flap
7. Side Flap

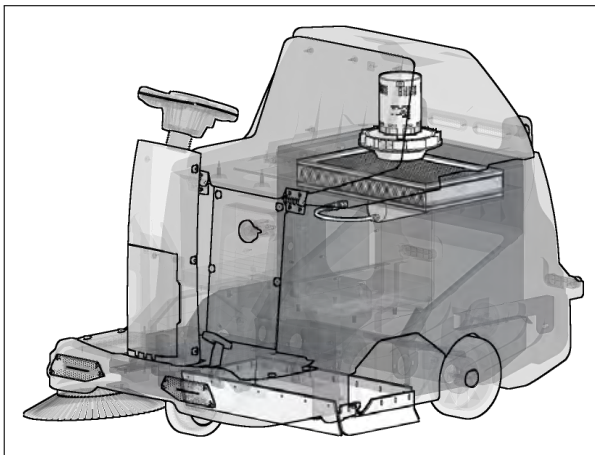

### 8.2 Description

The vacuum system is used to collect dust or the small residues that normally can not be collected by the mechanical action of the broom.

For this reason, **the main broom** works within a chamber composed of rubber blades.

In this chamber is created a depression by means of a vacuum system which generates a flow of air from the suction chamber that is conveyed through the debris hopper and then is filtered and finally reissued in the atmosphere.

**The vacuum system** is composed of a motor-fan system.

**The employed filter** can be of different type depending on the specific needs. The two most widely used filter types are:

- Cloth Filter (or bag filter)
- Panel Filter

The **Cloth Filter** is washable. This makes it an excellent solution in extremely dusty environments or where the machine must be used very frequently.

The **Panel Filter** can be replaced very easily also by the operator. On the other hand it has a limited filtration area, it is not washable, and if it is clogged, it has to be replaced.

In both cases, the machine uses in synergy to filter a **Filter Shaker**. This device is used to keep the filter as clean as possible in working condition.

8-68

It should be used **regularly** (with variable interval depending on the floor conditions) and can be operated manually by the operator.

**While using the Filter Shaker, the suction is turned off.**

In case of use of the machine on a **wet surface**, the vacuum system must be switched off. This system in fact, as stated at the beginning, is used to collect dust and, in the case of wet floor, the powder is mixed with water on the floor, and certainly does not need the vacuum to be collected.

The aspiration **can be disabled** manually by the operator.

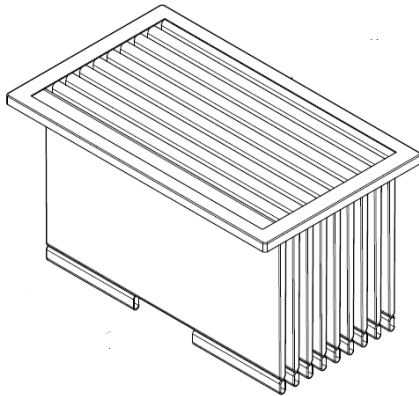

Figure 8.1: Cloth Filter



Figure 8.2: Panel Filter



## 8.3 Adjustments

### 8.3.1 Front Flap

The front flap practically has no type of adjustment, since the fixing screws of the flap to the frame have a unique possibility of fixing, as well as the flap rubber.

### 8.3.2 Rear Flap

The rear flap can be adjusted by means of the slots in the rubber. The rear flap must be adjusted in order to let the rubber be at 2mm from the ground.

### 8.3.3 Side Flap

The side flap can be adjusted by means of the slots in the rubber. The side flap must be adjusted in order to let the rubber be at 2mm from the ground.

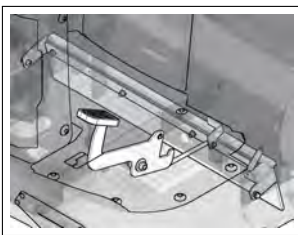

8.3.3-1 Front Flap

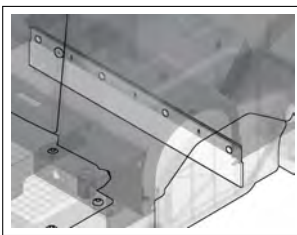

8.3.3-2 Rear Flap

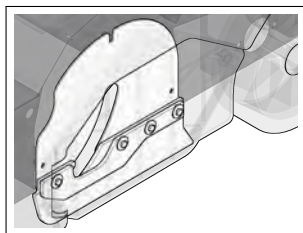

8.3.3-3 Side Flap

## 8.4 Maintenance and Checks

### 8.4.1 Front Flap

#### **Check** (to perform every 150h)

The front flap has to be flexible and should be very close to the ground. By using its pedal, the flap must be free to move. It doesn't have to show visible signs of wear or damage. Check the integrity of the flap and if it is necessary proceed to replace it.

### 8.4.2 Rear and Side Flap

#### **Check** (to perform every 150h)

The Rear and Side flaps have to be flexible and should be very close to the ground. They doesn't have to show visible signs of wear or damage. Check the integrity of the flap and if it is necessary proceed to replace it.

### 8.4.3 Vacuum Motor

#### **Check** (to perform every 150h)

In standard working conditions, the motor has a power consumption of about 20 Amps. Verify that this value is respected and verify that the motor is always clean. Check the integrity and size of the carbon brushes, and if necessary replace them.

#### **Maintenance** (to perform every 600h)

Motor carbon brushes replacement: *Procedure:*

- Put the machine in safe conditions.
- Lift the upper body / seat.
- Disconnect the battery connector.
- Loosen the screws that secure the collar brush guard.

- Disconnect the Carbon brushes from the input power line to the motor.
- Replace the carbon brushes being careful not to ruin them during assembly.
- Proceed to the reverse operations to reassemble it all.



#### 8.4.4 Vacuum Filter

**Check** (to perform every **4h**)

Make sure the filter is intact and has no cracks or visible damage. Verify, with machine totally in operation, that the air discharged by the vacuum system is clean and contain no dust.

**Maintenance** (to perform every **4h**)

Proceed thorough an accurate inspection and cleaning of the filter by blowing it, and in the case of cloth filter also to a possible washing. If necessary proceed to replace it (see section [4.4.3](#) at page [28](#)).

#### 8.4.5 Filter shaker

**Check** (to perform every **150h**)

Check the correct operation of the filter shaker and the integrity of its supports. Verify that the absorption of filter shaker is about 3.6 Amps.

## 8.5 Technical Features

TECHNICAL DESCRIPTION	U/M	FSR B	FSR Hybrid
Vacuum Motor Voltage	V	24	24
Filter shaker Voltage	V	24	24
Vacuum Motor Power	W	400	400
Filter shaker Power	W	80	80
Filtration area (Panel filter)	m <sup>2</sup>	3.2	3.2
Filtration area (Cloth filter)	m <sup>2</sup>	2.2	2.2

## 8.6 Consumable Spare Parts

PN	Description	FSR	
		B	Hybrid
438293	FRONT FLAP RUBBER	✓	✓
437880	REAR FLAP RUBBER	✓	✓
437882	LEFT SIDE FLAP RUBBER	✓	✓
437881	RIGHT SIDE FLAP RUBBER	✓	✓
411675	PANEL FILTER	✓	✓
<b>Carbon Brushes</b>			
415982	VAC.MOT.CARBON BR.	✓	✓

## 8.7 Recommended Spare Parts

PN	Description	FSR	
		B	Hybrid
223685	MOTOR MP80S/2 24V 2300G 400W + CONN.	✓	✓
223686	FILTER SHAKER MP50 W80 V24 + CONN.	✓	✓
416388	VACUUM FAN D.230	✓	✓

# Chapter 9

## Collection System

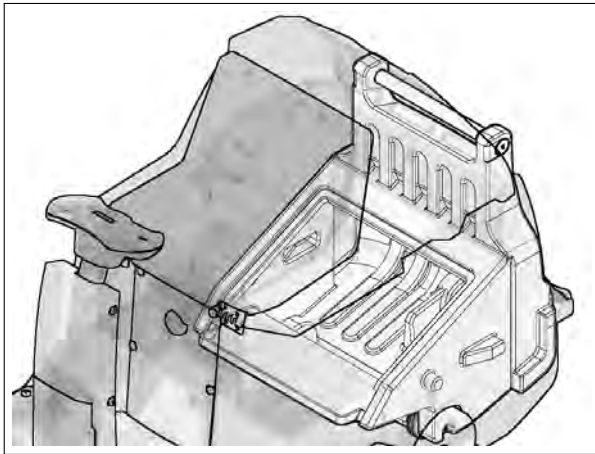

### 9.1 Structure

1. Debris Hopper

### 9.2 Description

**The function** of the collection system is to collect the dirt removed from the floor and to facilitate the discharge.

**The debris hopper** (the main part of the collection system) can be both front and rear. This hopper can be moved automatically or manually according to the type of machine where it is mounted.

In the **FSR** the debris hopper is rear and is manually operated.

## 9.3 Maintenance and Checks

### 9.3.1 Debris Hopper

**Check** *(to perform every 150h)*

The debris hopper must be kept clean. It is important to verify its integrity so that there are no leaks of pressure or loss of residues during work or transfer.

### 9.3.2 Wheels

**Check** *(to perform every 150h)*

The wheels must be intact and perfectly functioning in order to allow the correct movement of the debris hopper.

**Maintenance** *(to perform every 600h)*

The wheels should be checked and when the tread is no longer visible they must be replaced (see section [4.4.5](#) at page [29](#)).

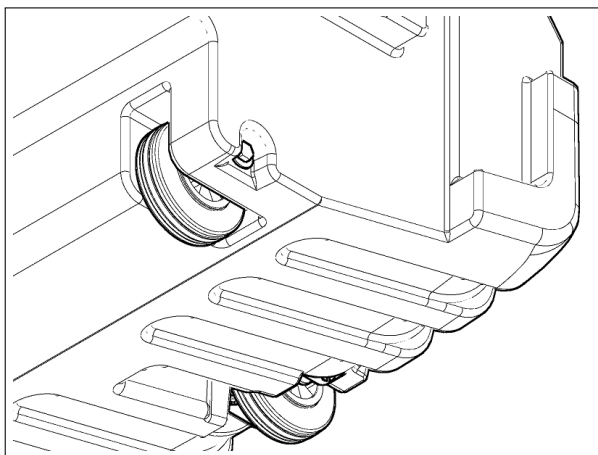

## 9.4 Technical Features

TECHNICAL DESCRIPTION	U/M	FSR B	FSR Hybrid
Debris Hopper Volume	dm <sup>3</sup>	20	20
Hopper Material	-	LLDPE	LLDPE
Handling system	-	Manual	Manual

## 9.5 Consumable Spare Parts

PN	Description	FSR	
		B	Hybrid
437904	BUSHING D=25-12 d=8 S=23 S235	✓	✓
414313	WHEEL D=100X35-45 PM55	✓	✓

# Chapter 10

## Machine Frame and Traction System

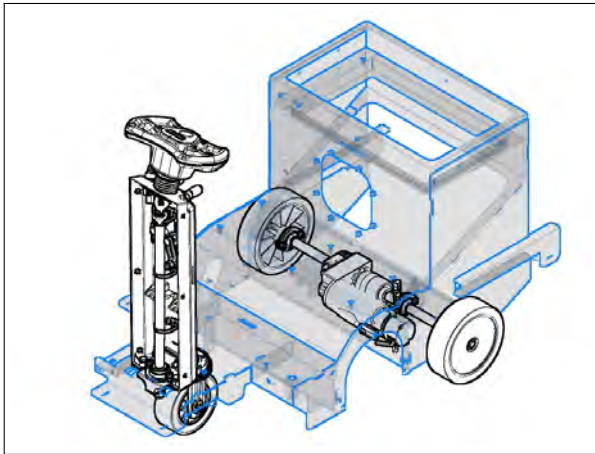

### 10.2 Description

**The frame** is a unique structure in painted steel. On it are coupled the steering system including the levers for the activation of the main broom and the side brush, and the traction system.

**The steering system** is composed by a steering column connected to a steering wheel, which acts directly on the front wheel. The steering is ensured by a pinion and a crown, connected by a chain. The pinion is welded directly onto the steering, while the crown is installed on the assembly front wheel.

**On top** of the steering column, there are the levers for the activation of the main broom and the side brush. To ensure the proper functioning of the two brush types, in the steering column are installed some microswitches that act directly on the affected systems.

**The traction** of the machine is guaranteed by an electric motor installed in combination with a gear, whose output shafts act directly on the rear wheels of the machine, ensuring traction.

**The gear motor** is equipped with an electrobrake which ensures the immobility of the machine when it is not moving. Both the front wheel the rear wheels are **non-marking** and **antiskid**.

### 10.1 Structure

1. Main broom and side brush lever system
2. Steering column
3. Front Wheel
4. Frame
5. Rear Wheels
6. Traction Motor

## 10.3 Adjustments

### 10.3.1 Steering wheel

The steering wheel should be adjusted when there is too much clearance between the chain that acts on the pinion connected to the steering bar of the steering wheel and the crown mounted on the front wheel.

#### Procedure

- Put the machine in safe conditions.
- Remove the steering wheel cover.
- Loosen the nuts securing the bottom support plate of the steering shaft.
- Release the grains locking nuts, set the optimum tension of the chain by acting on the grains, lock the adjustment by tightening the locking nuts.
- Once found the optimum tension retighten the fixing nuts to lock the bottom supporting plate of the steering shaft.
- Restore the steering wheel cover.

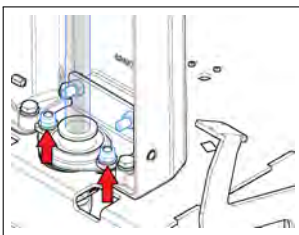

10.3.1-4 Steering adjustment

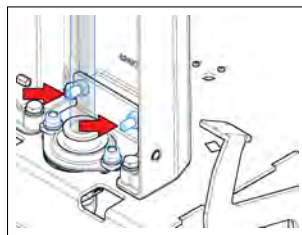

10.3.1-5 Steering adjustment

## 10.4 Maintenance and Checks

### 10.4.1 Levers

#### **Check** (to perform every 150h)

The operating levers of the main broom and the side brush, must always be operated with ease and without excessive effort from the operator.

#### **Maintenance** (to perform every 600h)

Replacement of the brass laminated bushings:

- Put the machine in safe conditions.
- Remove the steering wheel cover.
- Lower the main broom and the side brush.
- Unscrew the screws that hold the levers to the steering column and remove the internal levers.
- Proceed with the removal of the bushings and replace them with new bushings.
- Restore the steering wheel cover.

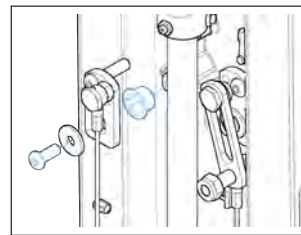

10.4.1-6 Bushings Replacement

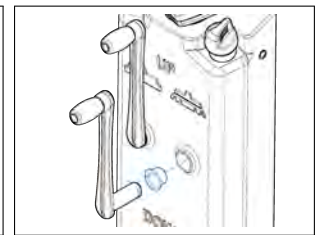

10.4.1-7 Bushings Replacement



## 10.4.2 Steering

### **Check** (to perform every 150h)

The steering must always be precise and free to rotate smoothly. Check that the ring and the pinion coupling chain has no excessive clearance and is not noisy.

### **Maintenance** (to perform every 600h)

Periodically grease the ring and pinion coupling chain. If the chain is too loose, adjust the chain tension as described in the "Settings" paragraph.

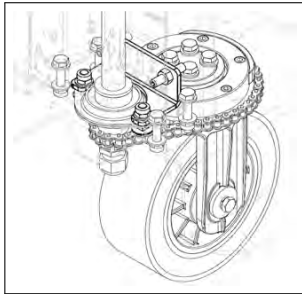

10.4.2-8 Steering system

## 10.4.3 Front Wheel

### **Check** (to perform every 150h)

The wheel must be free to rotate smoothly without friction. The wheel surface, must always be in good condition.

## 10.4.4 Rear Wheels

### **Check** (to perform every 150h)

The wheel surface, must always be in good condition.

### **Maintenance** (to perform every 600h)

Periodically check the wheel bearings status. Periodically grease the wheel bearings.

## 10.4.5 Traction motor

### **Check** (to perform every 150h)

During normal running, the current consumption must be between 5 and 7 Amps.

*ATTENTION* – At the start the absorption current of the motor is much higher.

The carbon brushes of the traction motor drive must be at least 6-8 mm long. The isolation of the power cables of the motor and the electrobrake, must be complete in all their parts and do not show signs of cracks. The cables must demonstrate flexibility. The activation lever of the electrobrake should activate only if a certain push is applied.

- With electrobrake engaged and the machine not powered, the machine itself should not move.
- With electrobrake engaged and the machine powered but not moving, the machine itself should not move.
- With electrobrake engaged, when acting the traction, the machine itself have to move.

Lifting the machine to make the rear wheels neutral, by spinning a wheel (in any sense) the other should turn in the opposite direction.

### **Maintenance** (to perform every 600h)

Motor carbon brushes replacement: *Procedure*:

- Put the machine in safe conditions.
- Remove the traction group from the machine (see section 4.5.4 at page 30).
- Mark the correct positioning of the motor hood before proceeding in the operation.
- Remove the plastic side covers and unscrew the screws that secure the hood to the motor (see fig. 10.4.5-10), (see fig. 10.4.5-11).

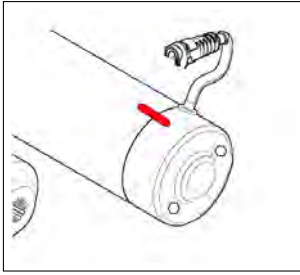

10.4.5-9 Motor Hood Positioning

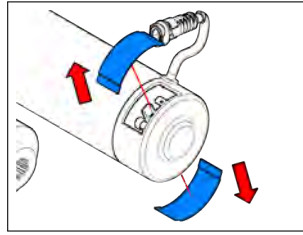

10.4.5-10 Side Covers

- Remove the connectors that fix the carbon brushes to the mains supply and remove the carbon brushes from the body of the hood (do not miss the compensating ring) (see fig. 10.4.5-12).

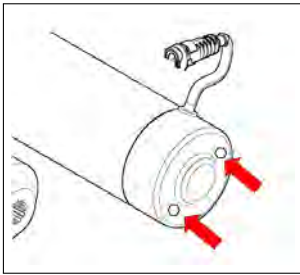

10.4.5-11 Fixing screws

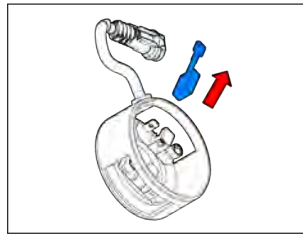

10.4.5-12 Carbon brushes removal

- Replace the carbon brushes being careful not to ruin them during assembly.
- Proceed to the reverse operations to reassemble everything.

## 10.5 Technical Features

TECHNICAL DESCRIPTION	U/M	FSR B	FSR Hybrid
Traction motor Voltage	V	24	24
Traction motor Power	W	300	300
Traction wheel ( <i>diam/width</i> )	Ømm/mm	175/60	175/60
Front Wheel material		Polyurethane	Polyurethane
Front Wheel hardness	Sh	85	85
Rear Wheel ( <i>diam/width</i> )	Ømm/mm	225/69	230/88
Rear Wheel material		Polyurethane	Pneumatic Rubber
Rear Wheel hardness	Sh	85	
Rear Wheel pressure	bar		3.5
Maximum forward speed	Km/h	4.8	4.8
Maximum reverse speed	Km/h	2.8	2.8

## 10.6 Consumable spare parts

PN	Description	FSR	
		B	Hybrid
436222	FRONT WHEEL D=175 d=20 S=60 WITH BEARINGS	✓	✓
426460	REAR WHEEL D=225 L=69	✓	
437947	PNEUMATIC REAR WHEEL D=230 L=88		✓
<b>Carbon Brushes</b>			
422462	TR. MOTOR CARBON BRUSHES	✓	✓

## 10.7 Recommended Spare Parts

PN	Description	FSR	
		B	Hybrid
222454	TRACTION MOTOR 24V 300W 115G 18A EL.BR.+ MOLEX	✓	✓

# Chapter 11

## Endothermic engine (FSR Hybrid)



Figure 11.1: Endothermic Engine

### 11.1 Structure

1. Description
2. Operation of the Hybrid Model
3. Endothermic Engine Components
4. Maintenance and Checks

### 11.2 Description

**The FSR Hybrid model** is equipped with an internal combustion engine powered by gasoline.

**The endothermic engine** is connected to an alternator so that, during gasoline operation, the on board batteries of the machine are properly recharged.

**At the same time**, always while operating with gasoline, the alternator has the task to provide adequate power supply to ensure the proper operation of the drive motor, vacuum motor, filter shaker motor and brushes motor.

**It is possible to alternate** working cycles on battery power to working cycles with power combustion engine.

**The operator** can easily select the power supply mode using the main switch (key).

**FSR is designed** to provide maximum efficiency in working condition and then whenever the power from the endothermic engine was shut down by the end of the fuel the sweeper machine automatically comes to work on battery power.

## 11.3 Operation of the Hybrid Model

### 11.3.1 Operation with battery power

To start the working cycle with battery power is sufficient to turn the main switch (key) in position I, the machine will start the work cycle by using the charge inside the battery installed on the machine until exhausted of the available charge.

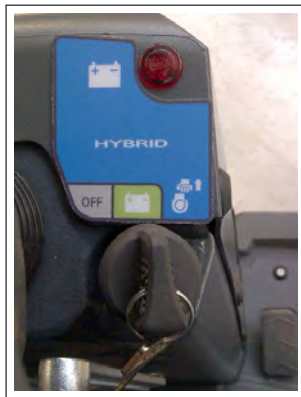

11.3.1-1 Main Switch - position I

### 11.3.2 Operation with Endothermic Engine

To start using the machine with power supply from Endothermic engine, it is necessary to:

- Turn the main switch (key) in position II (see fig. 11.3.2-2). On the machine's display will appear "START ENGINE" (see fig. 11.3.2-3).

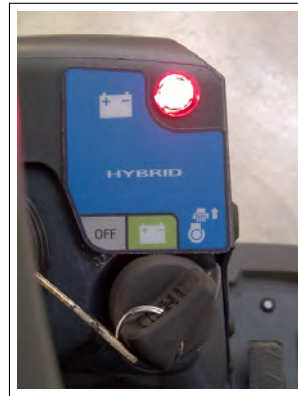

11.3.2-2 Main Switch - position II



11.3.2-3 Display signal

- To start a cold engine, move the choke lever to the CLOSED position.
- To restart a warm engine, leave the choke lever to the OPEN position.

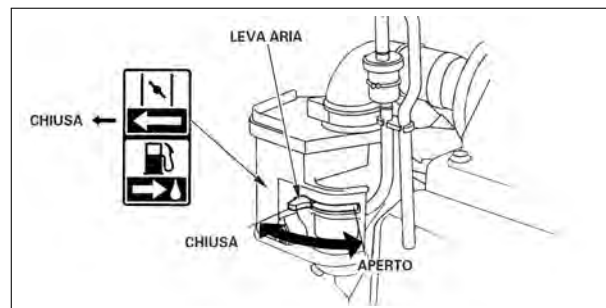

Figure 11.2: Choke lever

- Move the throttle lever to the middle position.



Figure 11.3: Throttle lever

- Pull the starter grip lightly until a certain resistance, then pull vigorously. Bring gently to the original position the starter handle. At this point the internal combustion engine is in operation.



Figure 11.4: Starter Handle

- If the choke lever has been put into the CLOSED position to start the engine, gradually move it to the OPEN position while the engine warms up.
- Place the choke lever on the maximum speed possible in order to allow the proper charging of the batteries.

At this point it is possible to start to use the machine for a normal working cycle.



## 11.4 Endothermic Engine

The Endothermic engine is composed of:

1. Fuel Tank
2. Choke Lever
3. Fuel Valve Lever
4. Starter Grip
5. Engine Switch
6. Air Filter
7. Oil Filler Cap/Dipstick
8. Spark Plug
9. Muffler
10. Oil Drain Hose
11. Throttle Lever / Motor turns

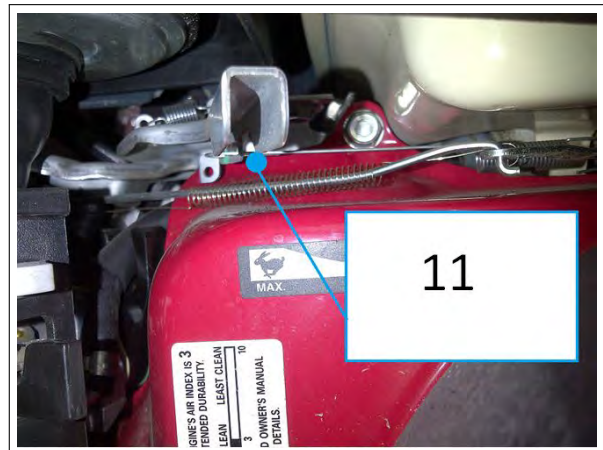
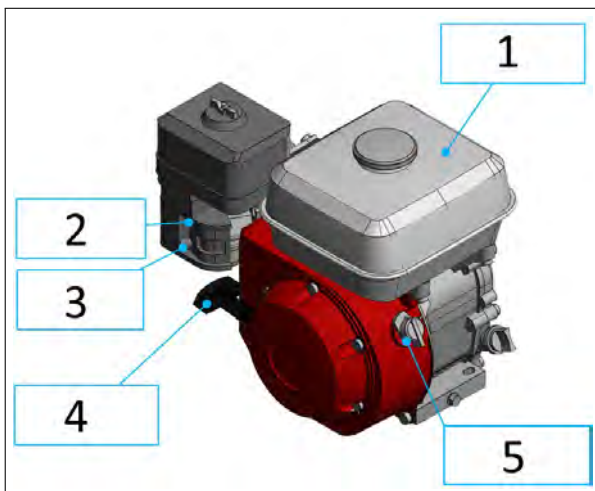
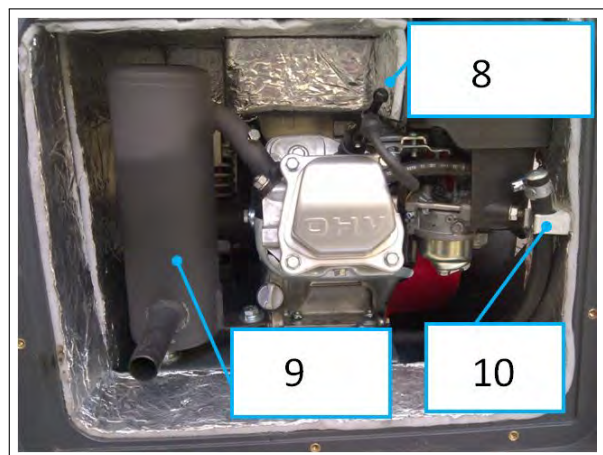
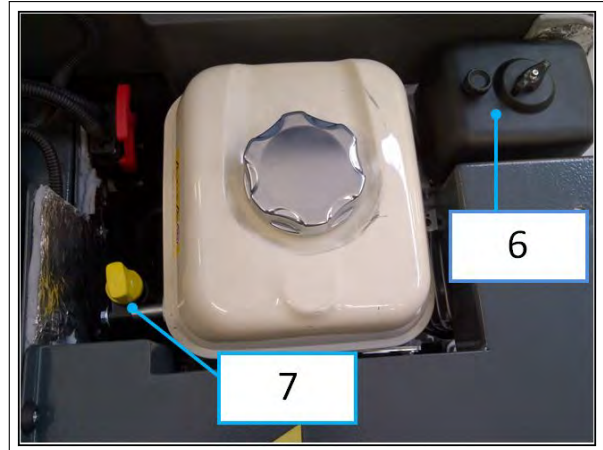

## 11.5 Maintenance and 11.5.2 Periodical Checks Checks

### 11.5.1 Checks before operation

Before using the sweeper machine powered by endothermic engine, it is necessary to check the following (make sure the engine is on a flat floor and that the engine switch is in the OFF position):

- Look around and underneath the engine for signs of oil or gasoline leaks, and remove them with a dry cloth.
- Remove any excessive dirt or debris, especially around the muffler and recoil starter.
- Check that all shields and covers are in place, and all nuts, bolts, and screws are tightened.
- Check the fuel level. Starting with a full tank will help to eliminate or reduce operating interruptions for refueling.
- Check the engine oil level. Running the engine with a low oil level can cause engine damage.
- Check the air filter element. A dirty air filter element will restrict air flow to the carburetor, reducing engine performance.

Good maintenance is essential for safe, economical and troublefree operation. The maintenance schedule applies to normal operating conditions. If you operate your engine under severe conditions, such as sustained high-load or high-temperature operation, or use in unusually wet or dusty conditions, consult your servicing dealer for recommendations applicable to your individual needs and use. For proper scheduling of periodic maintenance refer to the use and maintenance manual of the engine. In particular, for a prolonged and correct use of the engine it is necessary to take some precautions:

- This engine is certified to operate on unleaded gasoline with a pump octane rating of 86 or higher (a research octane rating of 91 or higher).
- Oil is a major factor affecting performance and service life. Use 4-stroke automotive detergent oil that meets or exceeds the requirements for API service classification SJ or later (or equivalent). SAE 10W-30 is recommended for general use.
- Check the engine oil level with the engine stopped and in a level position. If the oil level is near or below the lower limit mark on the dipstick, fill with the recommended oil to the upper limit mark. To Fill the oil level tank pull out the level dipstick and fill with recommended oil up to the upper limit mark. Do not overfill.





11.5.2-1 Oil Level check - Step 1.



11.5.2-2 Oil Level check - Step 2.

- From time to time and according to scheduled maintenance table in the endothermic engine manual, replace the engine oil. Use the special drain hose on the side of the engine to drain the oil tank. To drain the oil drain hose, remove the side protection ring, remove the hose from the clip and drain the contents of the tank by sliding the hose adjacent to the main brush.



11.5.2-3 Oil Replacement - Step 1.



11.5.2-4 Oil Replacement - Step 2.



11.5.2-5 Oil Replacement - Step 3.



11.5.2-6 Oil Replacement - Step 4.

- A dirty air filter will restrict air flow to the carburetor, reducing engine

performance. If the engine is operated in very dusty areas, clean the air filter often. To clean the filter remove the protective wing nut and remove the black plastic cover. At this point use a jet of air to properly clean the filtering body.

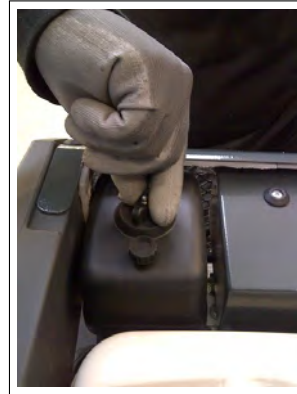

11.5.2-7 Air Filter Cleaning - Step 1.

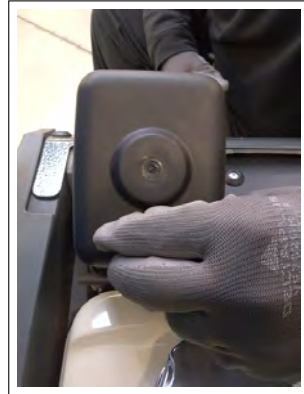

11.5.2-8 Air Filter Cleaning - Step 2.

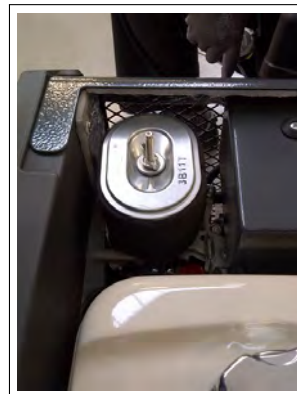

11.5.2-9 Air Filter Cleaning - Step 3.

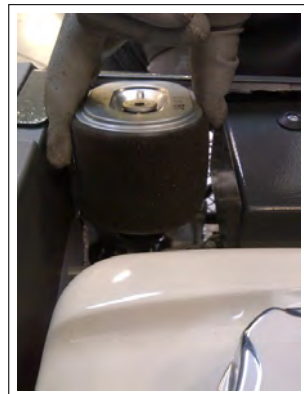

11.5.2-10 Air Filter Cleaning - Step 4.

- Choose a spark plug with the correct heat range for operating temperatures of the engine, as BP4ES (NGK) and W14EP-U (DENSO). To check the spark plug remove the side ring of protection and remove the spark plug cap. Measure the distance between the spark plug electrodes with a wire feeler gauge. Correct the distance as necessary, carefully bending the side electrode. The distance between the electrodes should be of from 0,70 to 0,80 mm.



11.5.2-11 Spark plug check - Step 1.

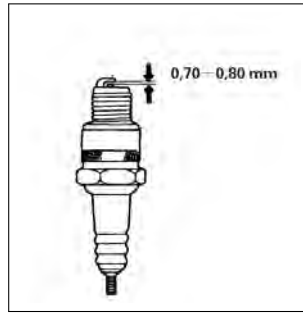

11.5.2-12 Spark plug check - Step 2.

## 11.6 Warnings

- Gasoline is highly flammable and explosive. Stop the engine and let it cool before refueling.
- The engine releases carbon monoxide which is a toxic poisonous gas. Do not operate in an enclosed area.

## 11.7 Technical Features

TECHNICAL DESCRIPTION	U/M	FSR Hybrid
Engine Dimensions (L x w x h)	mm	319 x 343 x 333
Dry mass (weight)	kg	18.6
Engine type		4 stroke single cylinder
Displacement	cm <sup>3</sup>	163
Net power	kW	3,6 at 3.600 rpm
Tank Fuel Capacity	l	3,1
Engine Oil Capacity	l	0,6
Cooling system		Forced air

# Part IV

## Accessories and Add-On

11-89

# Chapter 12

## Accessories

### 12.1 Accessories List

- Blinking Kit
- Onboard Charger Kit

### 12.2 Blinking Kit - 223421

#### 12.2.1 Description

The kit consists of a alarmflashing yellow light. Although this light is not considered mandatory by law, if the user requires it for their particular needs is possible to equip the machine with this accessory.

#### 12.2.2 Installing instructions

- Unplug the power cable of the batteries.
- Place the rubber circular base provided with the kit at the predisposition on the present on top of the rear body as shown in the following image.



12.2.2-13

- Place the blinker on the rubber base so as shown in the figure so as to match between rubber base and body of the blinker the three holes for the fixing screws crosswise (screws M3x16).
- Drill the appropriate holes for the three screws.
- Drill a similar central hole for the passage of the power cable (the hole must have be diameter 6). Final Result (see fig. 12.2.2-14).



12.2.2-14

- Pass the power cord into the diameter 6 hole and tighten the two power contacts to the body of the blinker.
- Secure to the rear body, the blinker and rubber base using the 3 screws and 3 nuts supplied with the kit.



12.2.2-15

- Connect the power cord connector of the blinker to the electrical system connector inside the rear body.
- Reconnect the battery cables and proceed to a functional check of the machine.

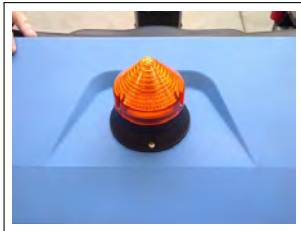

12.2.2-16

## 12.3 Onboard Charger Kit (only FSR B) - 223390

### 12.3.1 Description

The machine is available in "CB" version which is the version with the built in charger. Anyway, in a standard machine, the battery charger can be fitted acting as follows.

### 12.3.2 Machine Preparation

Before to start the kit installation is mandatory to put the machine in safe condition. Switch off the machine and unplug the batteries.

### 12.3.3 Installing instructions

- To properly install the Battery Charger remove from the rear compartment the vacuum motor, the filter and the filter shaker.



12.3.3-17



12.3.3-18

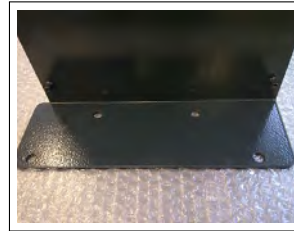

12.3.3-19 Battery charger support bracket

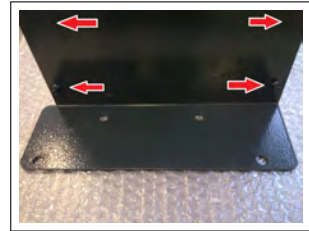

12.3.3-20 Battery charger fixing holes

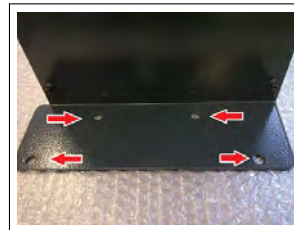

12.3.3-21 fixing holes to the machine frame

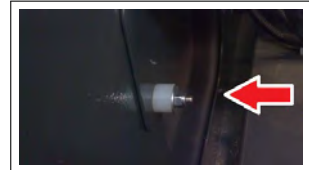

12.3.3-22 Spacer

- Attach the charger to the mounting plate using the 4 screws supplied with the kit and secure the wiring.

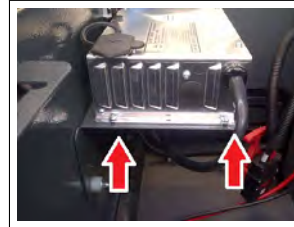

12.3.3-23

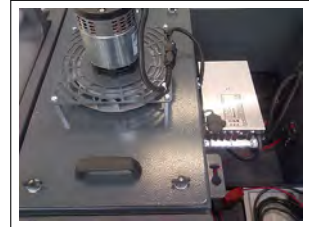

12.3.3-24

- Remove the screws in the clamp inserts in which will be fitted the support plate of the charger. Use the screws and spacers provided in the kit to secure the mounting plate.
- Attach the support plate using the screws and spacers provided in the kit. The slotted holes will be used for the support of the charger and the remaining holes for fixing the bracket to the frame machine.



Fimap S.p.A.  
Workshop Handbook FSR

Fimap S.p.A. Via Invalidi del Lavoro, 1 - 37050 S.Maria di Zevio Verona - ITALY  
Tel. +39 045 6060411 - Fax +39 045 6060417  
Edizione: February 11, 2014