

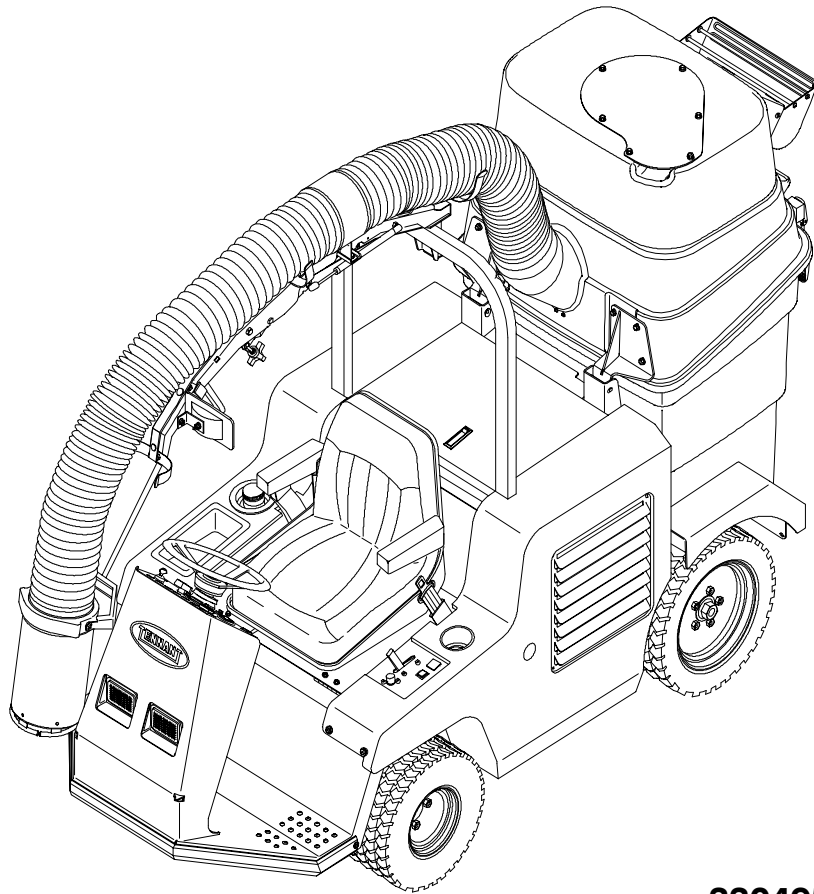

ATLV™ 4300

Service Manual



330495

Rev. 03 (5-02)





This service manual is intended to be used as an aid in the detailed service, repair, and troubleshooting of your TENNANT Model ATLV-4300.

The set is organized into six major groups: General Information, Chassis, Vacuuming, Electrical, Hydraulics, and Engine-D.

General Information: Safety precautions, machine specifications, machine maintenance chart, machine tieing, machine jacking, machine storing, machine pushing or towing, and hardware information.

Chassis: Tire/wheel replacement, brake adjustment and replacement, steering adjustment and replacement.

Vacuuming: Hopper repair/replacement, vacuum head repair/replacement, skirt/seal repair/replacement, and vacuuming troubleshooting.

Electrical: Battery maintenance and replacement, electrical schematics, and electrical troubleshooting.

Hydraulics: Valve replacement, motor replacement/repair, cylinder replacement/repair, pump replacement/repair, filter replacement, hydraulic schematic, and hydraulic troubleshooting.

Engine - D: Air filter replacement, oil changing, cooling system maintenance/repair, engine troubleshooting, engine removal, and engine repairs.

Manual Number - 330495

Revision: 03

Published: 5-02

CONTENTS

	Page
SAFETY PRECAUTIONS	1-3
SPECIFICATIONS	1-6
GENERAL MACHINE	
DIMENSIONS/CAPACITIES	1-6
GENERAL MACHINE PERFORMANCE	1-6
POWER TYPE	1-7
STEERING	1-7
HYDRAULIC SYSTEM	1-7
BRAKING SYSTEM	1-7
TIRES	1-7
MACHINE DIMENSIONS	1-8
MAINTENANCE	1-10
MAINTENANCE CHART	1-10
PUSHING, TOWING, AND	
TRANSPORTING THE MACHINE	1-12
PUSHING OR TOWING THE	
MACHINE	1-12
TRANSPORTING THE MACHINE	1-13
MACHINE JACKING	1-15
STORING MACHINE	1-15
HARDWARE INFORMATION	1-16
STANDARD BOLT TORQUE CHART	1-16
METRIC BOLT TORQUE CHART ...	1-16
BOLT IDENTIFICATION	1-16
THREAD SEALANT AND LOCKING	
COMPOUNDS	1-16
HYDRAULIC FITTING INFORMATION ..	1-17
HYDRAULIC TAPERED PIPE FITTING	
(NPT) TORQUE CHART	1-17
HYDRAULIC TAPERED SEAT FITTING	
(JIC) TORQUE CHART	1-17
HYDRAULIC O-RING FITTING TORQUE	
CHART	1-17

SAFETY PRECAUTIONS

The following symbols are used throughout this manual as indicated in their description:



WARNING: To warn of hazards or unsafe practices that could result in severe personal injury or death.

FOR SAFETY: To identify actions that must be followed for safe operation of equipment.

The machine is suited to vacuum disposable debris. Do not use the machine other than described in this Operator Manual.



WARNING: Machine Can Emit Excessive Noise. Consult With Your Regulatory Agency For Exposure Limits. Hearing Loss Can Result. Wear Hearing Protection.



WARNING: Moving fan blades. Keep away.



WARNING: Sharp objects in debris canister. Wear gloves.



WARNING: Spinning fan. Stop engine before opening debris canister.



WARNING: Engine Emits Toxic Gases. Severe Respiratory Damage Or Asphyxiation Can Result. Provide Adequate Ventilation. Consult With Your Regulatory Agency For Exposure Limits. Keep Engine Properly Tuned.

The following information signals potentially dangerous conditions to the operator or equipment:

FOR SAFETY:

1. **Do not operate machine:**
 - Unless trained and authorized.
 - Unless operation manual is read and understood.
 - In flammable or explosive areas unless designed for use in those areas.
 - In areas with possible falling objects unless equipped with overhead guard.
2. **Before starting machine:**
 - Make sure all safety devices are in place and operate properly.
 - Check brakes and steering for proper operation.
3. **When starting machine:**
 - Keep foot on brake and directional pedal in neutral.
4. **When using machine:**
 - Use brakes to stop machine.
 - Go slowly on inclines and slippery surfaces.
 - Use care when reversing machine.
 - Do not carry riders on machine.
 - Always follow safety and traffic rules.
 - Report machine damage or faulty operation immediately.
5. **Before leaving or servicing machine:**
 - Stop on level surface.
 - Set parking brakes.
 - Turn off machine and remove key.
6. **Before Opening Or Emptying Hopper:**
 - Stop on level surface.
 - Set parking brakes.
 - Turn off vacuum.
 - Turn off machine and remove key.
7. **When servicing machine:**
 - Avoid moving parts. Do not wear loose jackets, shirts, or sleeves.
 - Block machine tires before jacking machine up.
 - Jack machine up at designated locations only. Block machine up with jack stands.
 - Use hoist or jack that will support the weight of the machine.
 - Wear eye and ear protection when using pressurized air or water.
 - Disconnect battery connections before working on machine.
 - Avoid contact with battery acid.
 - Avoid contact with hot engine coolant.
 - Allow engine to cool.
 - Keep flames and sparks away from fuel system service area. Keep area well ventilated.
 - Use cardboard to locate leaking hydraulic fluid under pressure.
 - Use TENNANT supplied or approved replacement parts.

8. When loading/unloading machine onto/off truck or trailer:
- Use truck or trailer that will support the weight of the machine.
 - Use Winch. Do not drive the machine onto/off the truck or trailer unless the load height is 380 mm (15 in) or less from the ground.
 - Set parking brake after machine is loaded.
 - Block machine tires.
 - Tie machine down to truck or trailer.

The following safety labels are mounted on the machine in the locations indicated. If these or any label becomes damaged or illegible, install a new label in its place.

SHARP OBJECTS HAZARD LABEL - Located On The Air Deflector.



MOVING FAN HAZARD LABEL- Located On The Debris Canister.



FOR SAFETY LABEL - Located Below The Operator Seat.



FAN WARNING LABEL - Located In The Engine Compartment



EMISSIONS LABEL - Located Below The Operator's Seat.

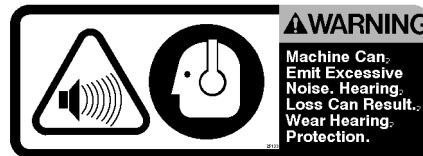

NOISE WARNING LABEL - Located Below The Operator's Seat.

GENERAL INFORMATION

SPECIFICATIONS

GENERAL MACHINE DIMENSIONS/CAPACITIES

Item	Dimension/capacity
Length	2590 mm (102 in)
Width	168 mm (46 in)
Height	2113 mm (83 in)
Track	965 mm (38 in)
Wheelbase	1320 mm (52 in)
Hopper weight capacity	68 kg (150 lb)
Hopper volume capacity	416 L (110 gal)
Water dust control tank capacity (option)	30 L (8 gal)
GVWR	910 kg (2600 lb)
Axle rating (front and rear)	680 kg (1500 lb)

GENERAL MACHINE PERFORMANCE

Item	Measure
Maximum forward speed	26 kmh (16 mph)
Maximum reverse speed	8 kmh (5 mph)
Minimum isle turn	4064 mm (160 in)
Minimum turning radius	457 mm (18 in)
Maximum rated climb and descent angle	12° / 21% Empty or Full hopper

POWER TYPE

Engine	Type	Ignition	Cycle	Aspiration	Cylinders	Bore	Stroke
Kubota	Piston	Diesel	4	Natural	3	78 mm (3.07 in)	78.5mm (3.09 in)
	Displacement		Net power, governed		Net power, maximum		
	1.1 L (60.9 cu in)		20.9 kw (28 hp) @ 3000 rpm Turbo engine-28.0 kw (38 hp)@ 3000		20.9 kw (28 hp) @ 3000 rpm Turbo engine-28.0 kw (38 hp)@ 3000		
	Fuel		Cooling system		Electrical system		
	Diesel Fuel tank: 31.42 L (8.3 gal)		Water/ethylene glycol antifreeze		12 V nominal		
			Total: 4 L (1 gal)		30 A alternator		
						12V Battery - 730 cca	
	Idle speed, no load		Governed speed, under load				
	1200 rpm		3000 rpm maximum				
	Engine lubricating oil with filter						
5.2 L (5.5 qt) 10W30 SAE-CD/SE rated engine oil							

STEERING

Type	Power source	Emergency steering
Front wheels, hydraulic cylinder, steering rod	Hydraulic accessory pump	Manual

HYDRAULIC SYSTEM

System	Capacity	Fluid Type
Hydraulic reservoir	19 L (5 gal)	TENNANT part no. 65869 - above 7° C (45°F)
Hydraulic total	21 L (5.5 gal)	TENNANT part no. 65870 - below 7° C (45°F)

BRAKING SYSTEM

Type	Operation
Service brakes	Cable actuated disc brakes, one per each rear wheel
Parking brake	Utilize service brakes on rear wheels, cable actuated

TIRES

Location	Type	Size	Ply Rating	Pressure
Front (2)	Pneumatic	216 mm (8.5 in) x 457 mm (18 in)	4 Ply	152 kPa (22 psi)
Rear (2)	Pneumatic	216 mm (8.5 in) x 584 mm (23 in)	4 Ply	124 kPa (18 psi)
Rear (2) (Optional)	Pneumatic Traction	216 mm (8.5 in) x 584 mm (23 in)	4 Ply	48 kPa (7 psi)

GENERAL INFORMATION

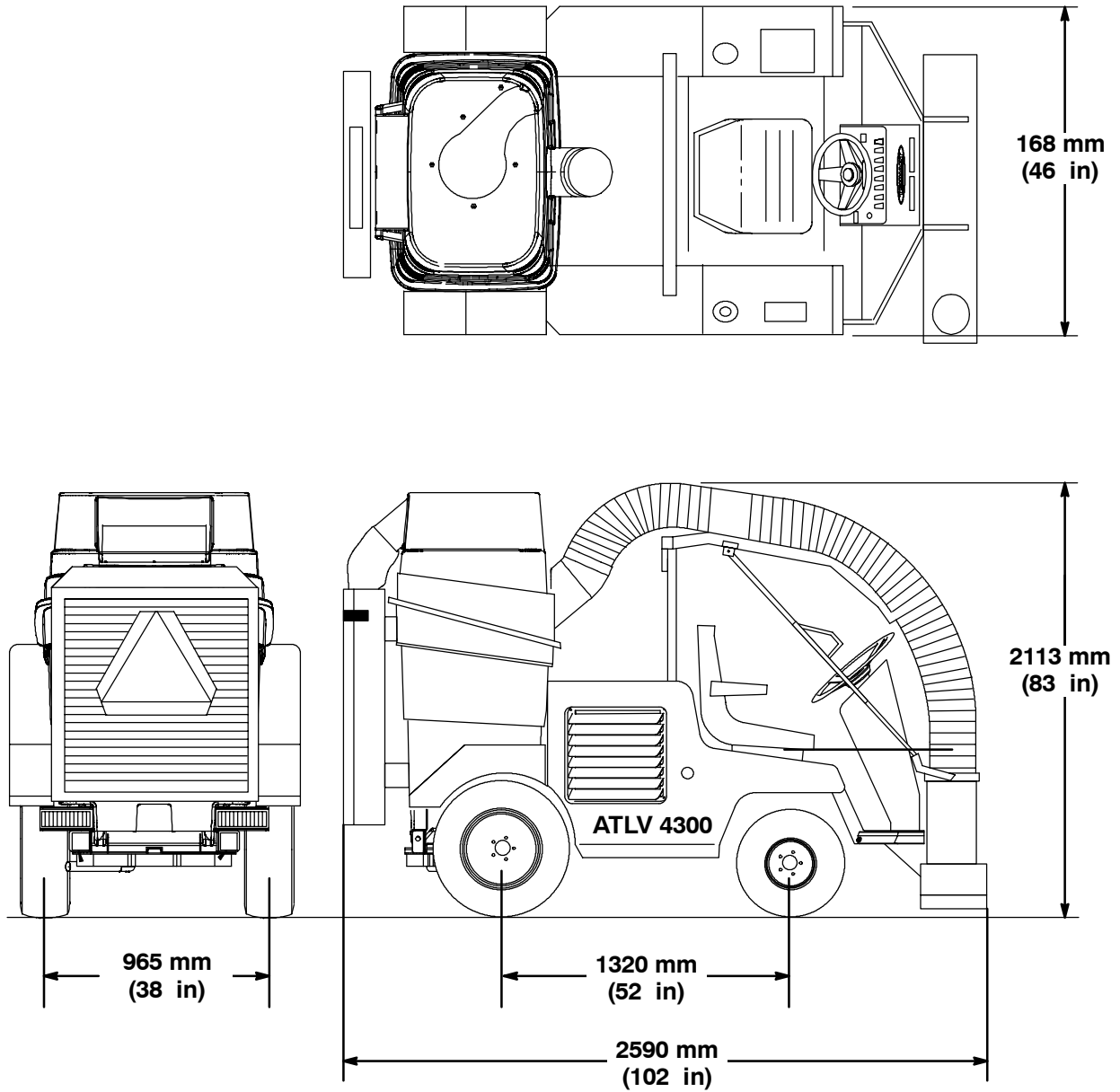

MACHINE DIMENSIONS

MAINTENANCE

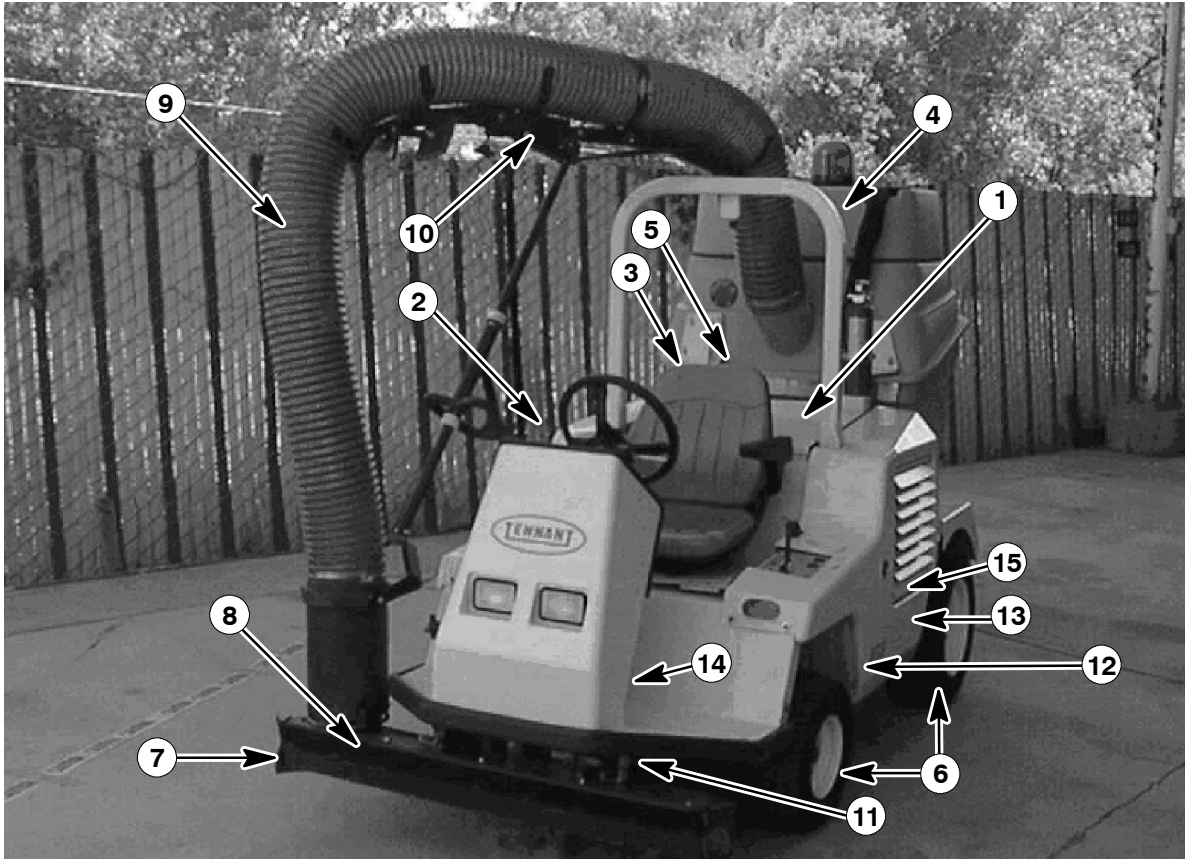

MAINTENANCE CHART

Interval	Key	Description	Procedure	Lubricant/ Fluid	No. of Service Points
Daily	1	Engine air filter	Check indicator	-	1
		Engine dust cap	Empty	-	1
		Engine crankcase	Check oil level	EO	1
	2	Radiator	Check and clean inlet screen	-	1
			Check coolant level in overflow reservoir	WG	1
	10	Vacuum hose support arm	Check for damage and wear	-	3
			Check gas cylinders for wear	-	2
	7	Vacuum head skirts (option)	Check for damage and wear	-	1
	8	Vacuum head (option)	Check for damage, wear, and adjustment	-	1
			Check for blockage	-	1
	9	Vacuum hose	Check for damage and blockage	-	1
	4	Vacuum fan screen	Check for debris and clean	-	1
		Vacuum bag	Check for debris and clean	-	1
		Dust filter bag (option)	Check for debris and clean	-	1
		Dust panel filter (option)	Check for debris and clean	-	1
Water dust control (option) spray nozzle		Check for debris and adjustment	-	1	

GENERAL INFORMATION

Interval	Key	Description	Procedure	Lubricant/ Fluid	No. of Service Points
50 Hours	5	Fuel lines and clamps	Check for tightness and wear		4
	2	Radiator core	Check and clean	-	2
	3	Hydraulic cooler core	Check and clean	-	1
	6	Tires	Check pressure	-	4
100 Hours	1	Engine crankcase	■ Change oil and filter element	EO	1
		Engine fan belt	Check tension	-	1
		Engine air filter	Replace	-	1
		Hydraulic reservoir	Check fluid level	-	6
	4	Vacuum bag	Check for wear and damage	-	1
		Dust panel filter (option)	Check for wear and damage	-	1
200 Hours	2	Radiator hoses and clamps	Check for tightness and wear	-	2
	11	Steering cylinder	Lubricate steering cylinder	SPL	2
	13	Brakes	Check brake adjustment	-	2
	12	Wheel pivot points	Lubricate pivots	SPL	2
	5	Fuel filter	Replace	-	1
	5	Fuel screen	Clean	-	1
	6	Tires	Check wear and rotate	-	4
	3	Hydraulic hoses	Check for wear and damage	-	All
	1	Battery	■ Clean and tighten battery cable connections	-	1
			Check electrolyte level	DW	1
	14	Directional pedal	Check for wear, lubricate	-	2
	1	Engine door seals	Check for wear	-	4
	4	Water dust control (option) waterlines and clamps	Check for tension and wear	-	6
	-	Windshield wiper blades (option)	Check for wear	-	2
800 Hours	3	Hydraulic reservoir	Replace filler cap and suction strainer	-	1
			Change hydraulic fluid	HYDO	1
		Hydraulic fluid filter	Change filter element	-	1
	-	Hydraulic drive motors	Check for wear and damage	-	1
	2	Cooling system	Flush	WG	1
6	Wheels	■ Check wheel nut torque	-	4	

LUBRICANT/FLUID

EO . . . Engine oil, 10W-30-CD/SE rated

HYDO . TENNANT or approved hydraulic fluid

SPL . . . Special lubricant, Lubriplate EMB grease (TENNANT part no. 01433-1)

WG . . . Water and permanent-type ethylene glycol anti-freeze, -34° C (-30° F)

DW . . . Distilled water

Note: Also check procedures indicated (■) after the first 50-hours of operation.

Note: More frequent intervals may be required in extremely dusty conditions.

GENERAL INFORMATION

PUSHING, TOWING, AND TRANSPORTING THE MACHINE

PUSHING OR TOWING THE MACHINE

If the machine becomes disabled, it can be pushed from the front or rear, but towed only from the front.

The propelling pump has a bypass valve to prevent damage to the hydraulic system when the machine is being pushed or towed. This valve allows a disabled machine to be moved for a *very short distance* and at a speed to not exceed 1.6 kp/h (1 mph). The machine is NOT intended to be pushed or towed a long distance or at a high speed.

ATTENTION! Do not push or tow machine for a long distance and without using the bypass valve, or the machine hydraulic system may be damaged.

Turn the bypass valve 90° from the normal position before pushing or towing the machine. **The illustration shows the bypass valve in the pushing or towing position.**

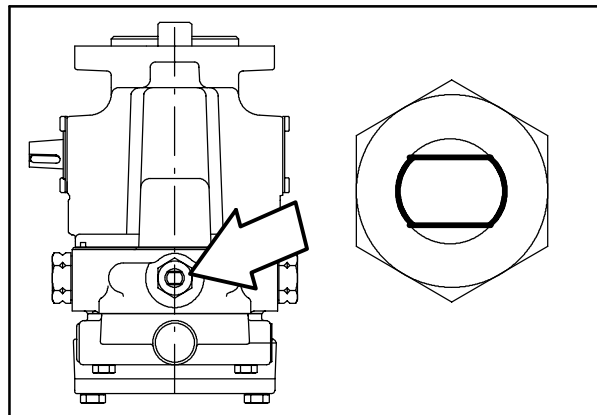
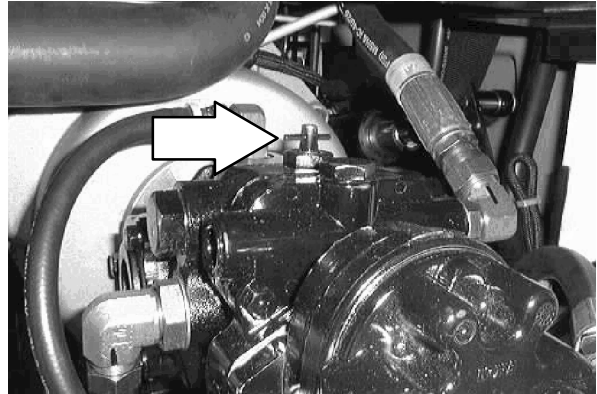

TRANSPORTING THE MACHINE

1. Position the rear of the machine at the loading edge of the truck or trailer.

FOR SAFETY: Use truck or trailer that will support the weight of the machine.

NOTE: Empty the hopper before transporting the machine.

2. If the loading surface is not horizontal or is higher than 380 mm (15 in) from the ground, use a winch to load machine.

If the loading surface is horizontal AND is 380 mm (15 in) or less from the ground, the machine may be driven onto the truck or trailer.

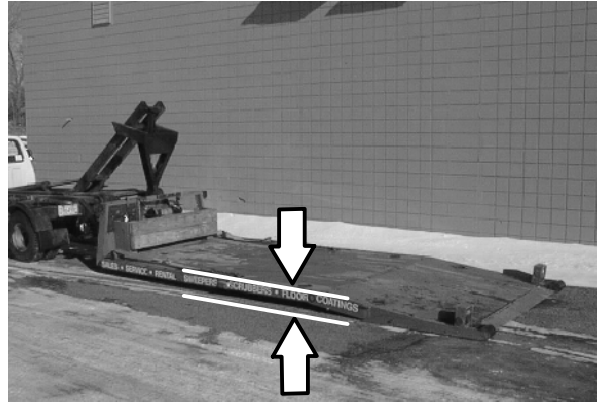

3. To winch the machine onto the truck or trailer, attach the winching chains to the rear tie down locations. The rear tie-down locations are through the rear holes of the frame.



4. Turn the bypass valve 90° from the normal position before winching the machine onto the truck or trailer. See *PUSHING OR TOWING THE MACHINE* section of this manual. Make sure the machine is centered.

FOR SAFETY: When loading machine onto truck or trailer, use winch. Do not drive the machine onto the truck or trailer unless the loading surface is horizontal AND is 380 mm (15 in) or less from the ground.



5. Position the machine onto the truck or trailer as far as possible. If the machine starts to veer off the centerline of the truck or trailer, stop and turn the steering wheel to center the machine.

GENERAL INFORMATION

6. Set the parking brake, lower the vacuum head and block the machine tires. Tie down the machine to the truck or trailer before transporting.

If the machine does not have the optional tie down bracket, tie the front end down with a tie strap over the floor of the machine.

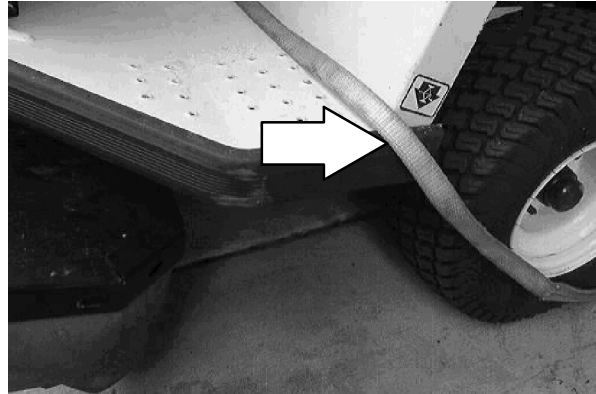

If the machine does have an optional tie down bracket, tie down the machine to the truck or trailer with it.

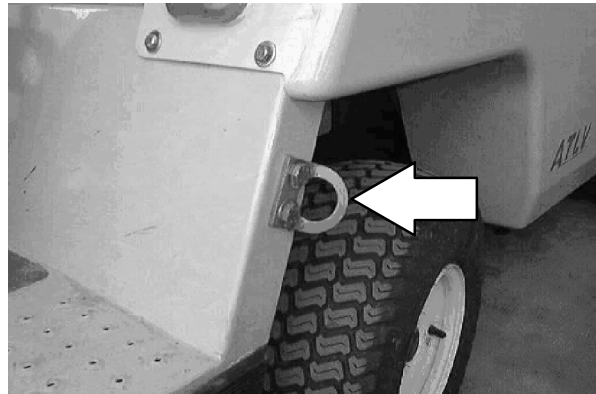

The rear tie-down locations are through the rear holes of the frame.

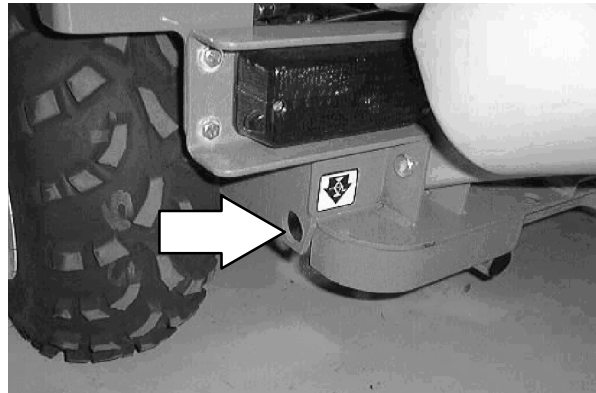

7. If the loading surface is not horizontal or is higher than 380 mm (15 in) from the ground, use a winch to unload machine.

If the loading surface is horizontal AND is 380 mm (15 in) or less from the ground, the machine may be driven off the truck or trailer.

FOR SAFETY: When unloading machine off truck or trailer, use winch. Do not drive the machine off the truck or trailer unless the loading surface is horizontal AND 380 mm (15 in) or less from the ground.

MACHINE JACKING

Empty the hopper before jacking the machine. You can jack up the machine for service at the designated locations. Use a hoist or jack that will support the weight of the machine.

Always stop the machine on a flat, level surface and block the tires before jacking up the machine.

The front jacking locations are on the frame near the front tires.

FOR SAFETY: When Servicing Machine, Block Machine Tires Before Jacking Machine Up.

FOR SAFETY: When Servicing Machine, Jack Machine Up At Designated Locations Only. Block Machine Up With Jack Stands.

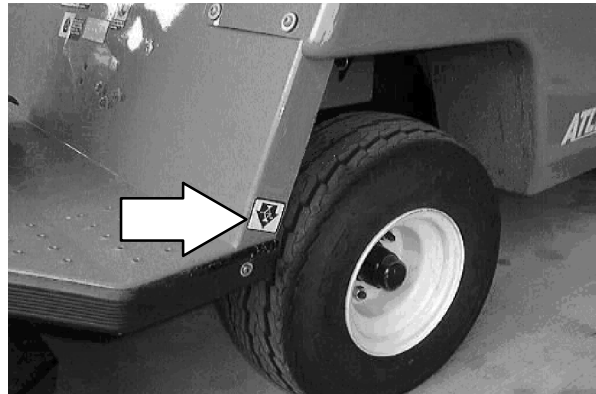

The rear jacking locations are below the rear bumper.

FOR SAFETY: When Servicing Machine, Block Machine Tires Before Jacking Machine Up.

FOR SAFETY: When Servicing Machine, Jack Machine Up At Designated Locations Only. Block Machine Up With Jack Stands.

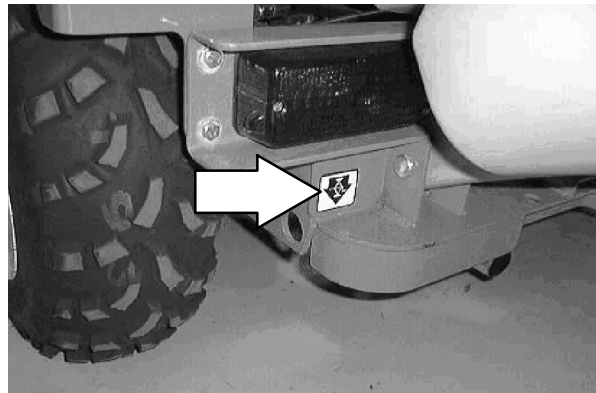

STORING MACHINE

Before storing the machine for an extended period of time, the machine needs to be prepped to lessen the chance of rust, sludge, and other undesirable deposits from forming. Contact TENNANT service personnel.

HARDWARE INFORMATION

The following charts state standard plated hardware tightening ranges for normal assembly applications. Decrease the specified torque by 20% when using a thread lubricant. Do not substitute lower grade hardware for higher grade hardware. If higher grade hardware than specified is substituted, tighten only to the specified hardware torque value to avoid damaging the threads of the part being threaded into, as when threading into speed nuts or weldments.

STANDARD BOLT TORQUE CHART

Thread Size	SAE Grade 5 Torque ft lb (Nm)	SAE Grade 8 Torque ft lb (Nm)
0.25 in	7-10 (9-14)	10-13 (14-38)
0.31 in	15-20 (20-27)	20-26 (27-35)
0.38 in	27-35 (37-47)	36-47 (49-64)
0.44 in	43-56 (58-76)	53-76 (72-103)
0.50 in	65-85 (88-115)	89-116 (121-157)
0.62 in	130-170 (176-231)	117-265 (159-359)
0.75 in	215-280 (291-380)	313-407 (424-552)
1.00 in	500-650 (678-881)	757-984 (1026-1334)

NOTE: Decrease torque by 20% when using a thread lubricant.

METRIC BOLT TORQUE CHART





Thread Size	Class 8.8 Torque ft lb (Nm)	Class 10.9 Torque ft lb (Nm)
M4	2 (3)	3 (4)
M5	4 (5)	6 (8)
M6	7 (9)	10 (14)
M8	18 (24)	25 (34)
M10	32 (43)	47 (64)
M12	58 (79)	83 (112)
M14	94 (127)	133 (180)
M16	144 (195)	196 (265)
M20	260 (352)	336 (455)
M24	470 (637)	664 (900)

NOTE: Decrease torque by 20% when using a thread lubricant.

Exceptions to the above chart:

Check the machine for exceptions!

BOLT IDENTIFICATION

Identification Grade Marking	Specification and Grade
	SAE-Grade 5
	SAE-Grade 8
	ISO-Grade 8.8
	ISO-Grade 10.9

01395

THREAD SEALANT AND LOCKING COMPOUNDS

Thread sealants and locking compounds may be used on this machine. They include the following:

Loctite 515 sealant - gasket forming material. TENNANT Part No. 75567, 15 oz (440 ml) cartridge.

Loctite 242 blue - medium strength thread locking compound. TENNANT Part No. 32676, 0.5 ml tube.

Loctite 271 red - high strength thread locking compound. TENNANT Part No. 19857, 0.5 ml tube.

HYDRAULIC FITTING INFORMATION

**HYDRAULIC TAPERED PIPE FITTING (NPT)
TORQUE CHART**

NOTE: Ratings listed are when using teflon thread seal.

Size	Minimum Torque	Maximum Torque
1/4 NPT	10 ft lb (14 Nm)	30 ft lb (41 Nm)
1/2 NPT	25 ft lb (34 Nm)	50 ft lb (68 Nm)
3/4 NPT	50 ft lb (68 Nm)	100 ft lb (136 Nm)

**HYDRAULIC TAPERED SEAT FITTING (JIC)
TORQUE CHART**

Tube O.D. (in)	Thread Size	Maximum Torque
0.25	0.44-20	9 ft lb (12 Nm)
0.38	0.56-18	20 ft lb (27 Nm)
0.50	0.75-16	30 ft lb (41 Nm)
0.62	0.88-14	40 ft lb (54 Nm)
0.75	1.12-12	70 ft lb (95 Nm)
1.0	1.31-12	90 ft lb (122 Nm)

**HYDRAULIC O-RING FITTING TORQUE
CHART**

Tube O.D. (in)	Thread Size	Minimum Torque	Maximum Torque
0.25	0.44-20	6 ft lb (8 Nm)	9 ft lb (12 Nm)
0.38	0.56-18	13 ft lb (18 Nm)	20 ft lb (27 Nm)
		*10 ft lb (14 Nm)	12 ft lb (16 Nm)
0.50	0.75-16	20 ft lb (27 Nm)	30 ft lb (41 Nm)
		*21 ft lb (28 Nm)	24 ft lb (33 Nm)
0.62	0.88-14	25 ft lb (34 Nm)	40 ft lb (54 Nm)
0.75	1.12-12	45 ft lb (61 Nm)	70 ft lb (95 Nm)
1.0	1.31-12	60 ft lb (81 Nm)	90 ft lb (122 Nm)

NOTE: Do not use sealant on o-ring threads.

*Aluminum bodied components

CONTENTS

	Page
INTRODUCTION	2-3
SEAT	2-4
OPERATOR SEAT	2-4
TO REMOVE SEAT ASSEMBLY ..	2-4
TO INSTALL SEAT ASSEMBLY ...	2-5
BRAKES AND TIRES	2-6
SERVICE BRAKES	2-6
TO REPLACE SERVICE BRAKE PADS 2-6	
TO REPLACE SERVICE BRAKE CABLE	2-8
TO ADJUST SERVICE/PARKING BRAKE	2-9
PARKING BRAKE	2-10
TIRES AND WHEELS	2-10
TO REPLACE FRONT TIRE AND WHEEL	2-10
TO REPLACE REAR TIRE AND WHEEL	2-11
TO ALIGN FRONT TIRES	2-12
STEERING	2-13
TO SET TURNING RADIUS STOPS	2-13
FRONT AXLE	2-14
TO REMOVE FRONT AXLE ASSEMBLY	2-14
TO INSTALL FRONT AXLE ASSEMBLY	2-16
TO REPLACE FRONT AXLE LEAF SPRING	2-18
TO REPLACE FRONT AXLE ROD END	2-19
PROPEL CABLE	2-20
TO REPLACE PROPEL CABLE ..	2-20
TO REPLACE PROPEL HYDROBACK	2-24
TO SET TRAVEL SPEEDS	2-26
TO ADJUST PROPEL NEUTRAL .	2-27

INTRODUCTION

This section includes information on the main chassis related components for example the seat, steering, brakes and tires.

SEAT

OPERATOR SEAT

The standard operators seat on the ATLV™ 4300 is a fixed back style with no adjustment for operator weight. The optional operators seat has an adjustable back and several settings for operator weight.



TO REMOVE SEAT ASSEMBLY

FOR SAFETY: Before Leaving Or Servicing Machine; Stop On Level Surface, Set Parking Brake, turn off machine, and remove key.

1. Raise the seat assembly and engage the prop rod.
2. Hold the seat up with an overhead hoist or a piece of wood.
3. Remove the four screws holding the seat support to the machine frame.
4. Disengage the prop rod and drop the seat assembly down slightly.
5. Remove the end of the prop rod through the access hole.
6. Remove the seat assembly from the machine.

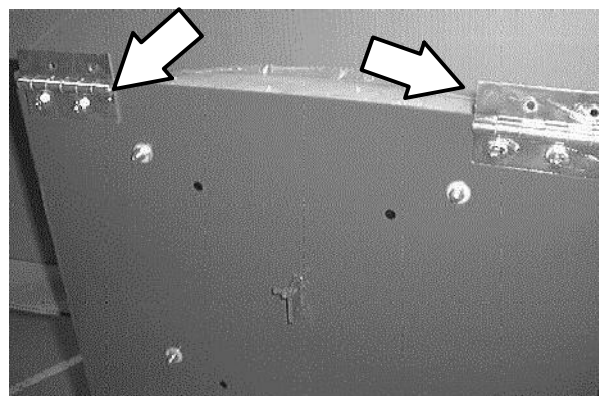
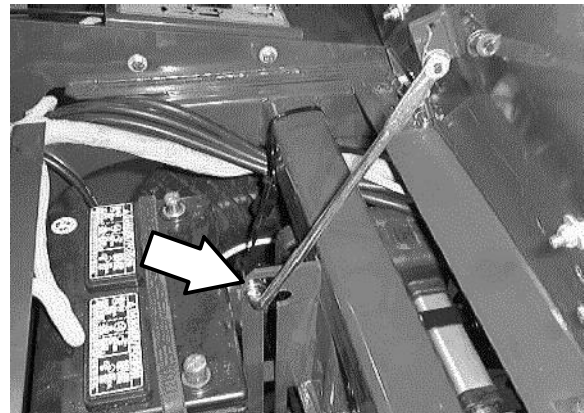

TO INSTALL SEAT ASSEMBLY

FOR SAFETY: Before Leaving Or Servicing Machine; Stop On Level Surface, Set Parking Brake, turn off machine, and remove key.

1. Position the seat assembly onto the machine.
2. Hold the seat up with an overhead hoist or a piece of wood.
3. Install the four hex screws and nuts. Tighten to 8 - 10 Nm (6 - 8 ft. lb).
4. Drop the seat down enough to place the end of the prop rod into the access hole.
5. Drop the seat assembly down and remove the hoist.

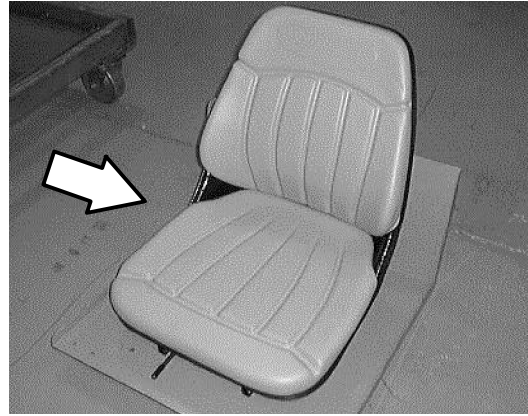

BRAKES AND TIRES

SERVICE BRAKES

The service brakes on the model ATLV™ 4300 are located on the rear wheels only. The service brakes are mechanically actuated with two pedals and two cables. The service brakes are independent left to right.

There is a left and right brake pedal in the operators compartment. These pedals can be actuated together or just the right or just the left pedal can be pressed.

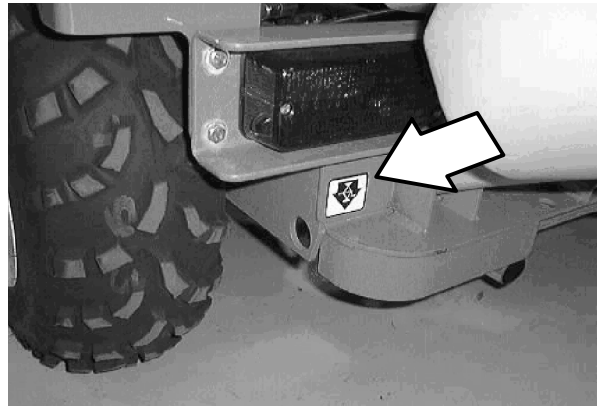
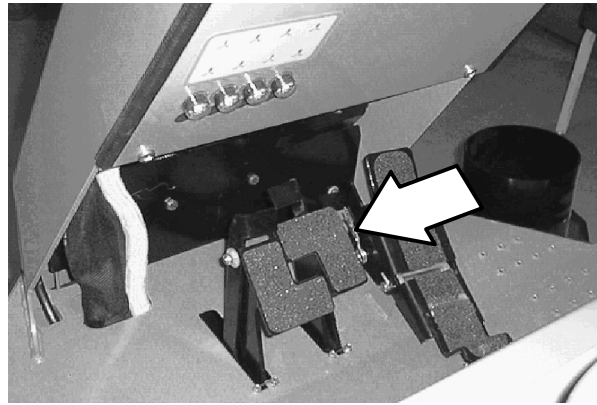

TO REPLACE SERVICE BRAKE PADS

FOR SAFETY: Before Leaving Or Servicing Machine; Stop On Level Surface, Set Parking Brake, turn off machine, and remove key.

1. Place blocks in front and back of the front tires.
2. Jack up the rear of the machine at the indicated jack points. Install jack stands under the machine frame.
3. Make sure the parking brake is engaged. Remove the five wheel nuts. Remove the tire and wheel assembly from the machine.
4. Lift the hopper cover and tilt the hopper back.
5. Disengage the parking brake.



6. Remove the tension spring and clevis pin from the brake cable clevis and arm on the brake assembly.
7. Remove the two M12 hex screws and nyloc nuts holding the brake assembly to the top side of the wheel motor.
8. Pull the brake assembly straight up and off the brake hub.
9. Remove the brake pads from the brake assembly. Note the orientation of the pads.
10. Install the new brake pads in the same orientation as the used ones.
11. Spread the new brake pads and slide the brake assembly onto the brake hub.
12. Align the holes in the brake assembly with the mount holes in the wheel motor.
13. Reinstall the hardware. Tighten to 64 - 83 Nm (47 - 61 ft. lb.)
14. Reinstall the clevis pin in the end of the brake cable at the brake arm.
15. Reinstall the tension spring on the brake arm.
16. Go to the operators compartment and press the brake pedal on the side where the brake pads were just replaced. Adjust the brake cable if necessary. See TO ADJUST BRAKE CABLE instructions in this section.
17. Engage the parking brake.
18. Reinstall the rear tire and wheel assembly.
19. Reinstall the five wheel nuts and tighten to 122 - 162 Nm (90 - 120 ft. lb).
20. Repeat this procedure on both sides of the machine.
21. Tilt the hopper forward and lower the hopper cover.
22. Remove the jack stands and lower the machine.
23. Remove the blocks from the front tires and disengage the parking brake.
24. Operate the machine and check the service brakes for proper operation.

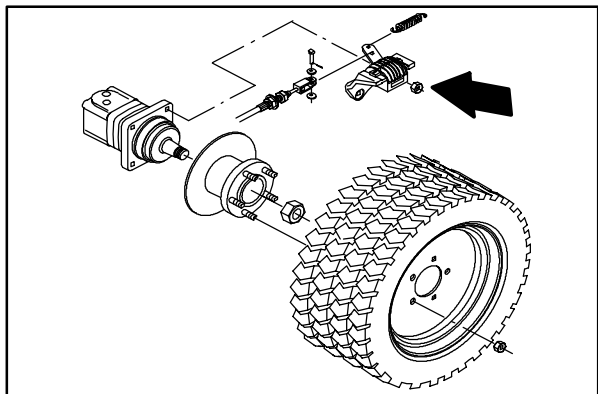
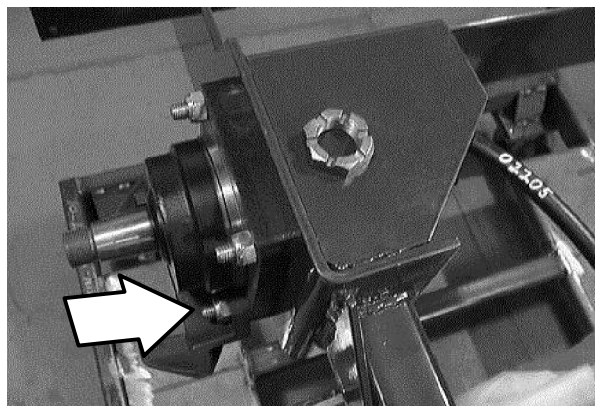
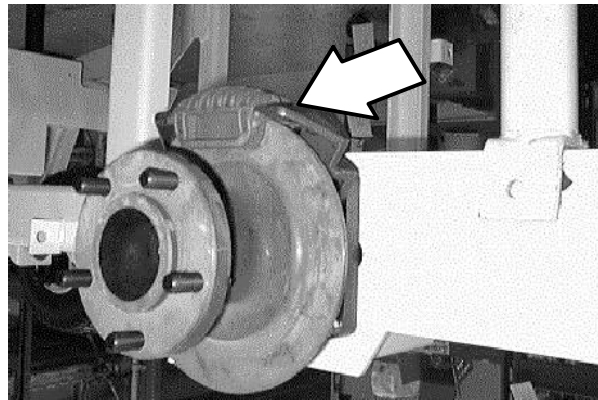
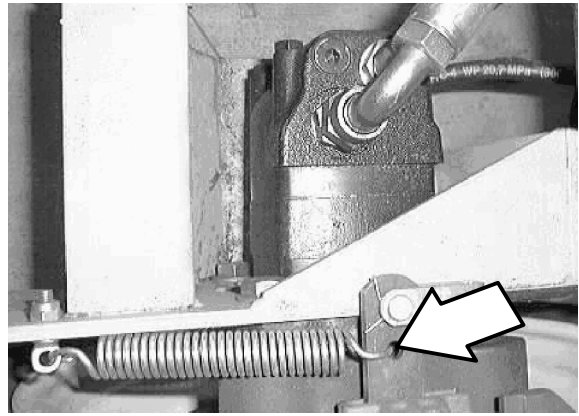

CHASSIS

TO REPLACE SERVICE BRAKE CABLE

1. Lower the vacuum head.

FOR SAFETY: Before Leaving Or Servicing Machine; Stop On Level Surface, turn off machine, and remove key.

2. Place blocks in front and back of the front tires.
3. Lift the hopper cover and tilt the hopper back.

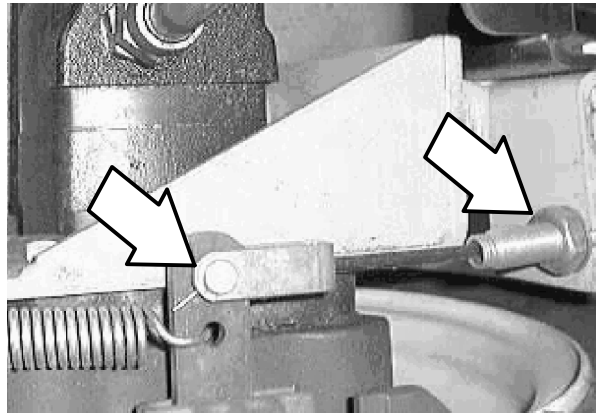

NOTE: Make sure the parking brake IS NOT engaged.

4. Remove the tension spring and clevis pin from the brake cable clevis and arm on the rear wheel brake assembly.
5. Loosen the large jam nut on the brake cable where it attaches to the frame bracket.
6. Go under the front of the machine and locate the lower part of the brake pedal assembly.
7. Remove the cotter pin and clevis pin from the end of the brake cable.
8. Loosen the large jam nut on the brake cable.
9. Note the routing of the brake cable and remove it from the machine.
10. Note the location of the clevis on the old cable and remove. Install on the new cable in the same location. Leave the small jam nuts loose for now.
11. Install the new cable in the machine. Make sure to route the new cable in the same manner that the old was routed.
12. Position the new cable into the mount hole at the front of the machine. Lightly finger tighten the large jam nut.
13. Reinstall the clevis pin and cotter pin into the clevis on the front of the new brake cable.
14. Go to the back of the machine and position the brake cable into the mount hole. Tighten the large jam nut.

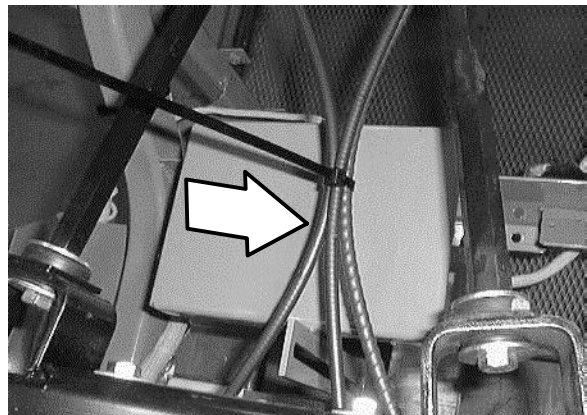
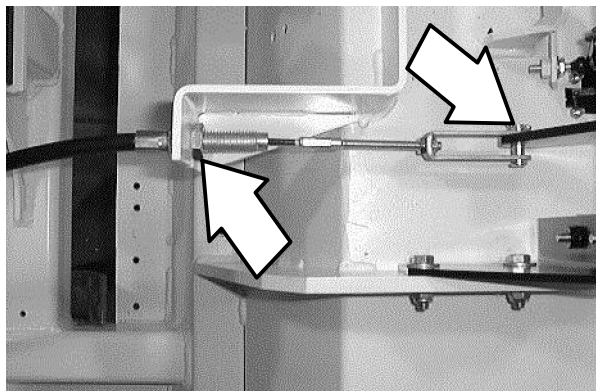

15. Reinstall the clevis pin and cotter pin into the clevis on the rear of the new brake cable.
16. Reinstall the the tension spring onto the rear brake assembly lever.
17. Check the foot pedal in the operators compartment for proper adjustment. The pedal should have less than 1" of free play. **Adjust the right pedal so it does not contact the frame. Set the left pedal so its surface is flush with the right pedal.** If the pedal needs to be adjusted--do so at the front clevis. Tighten the large and small jam nuts.
18. Reinstall any plastic ties that were removed.
19. Operate the machine and check the brakes for proper operation.

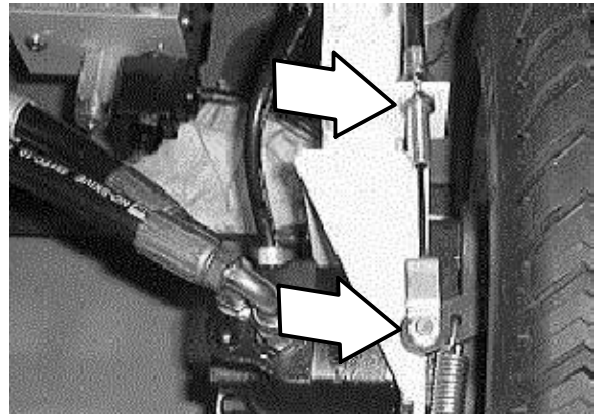

TO ADJUST SERVICE/PARKING BRAKE

1. Open the hopper cover and tilt the hopper back.

FOR SAFETY: Before Leaving Or Servicing Machine; Stop On Level Surface, Set Parking Brake, turn off machine, and remove key.

2. Check the foot pedal in the operators compartment for proper adjustment.
3. The pedal should have less than 1" of free play.

NOTE: Adjust the right pedal so it does not contact the frame. Set the left pedal so its surface is flush with the right pedal.

4. If the pedal needs to be adjusted--do so at the rear cable mount.
5. Loosen the jam nuts on the cable and adjust until there is a slight pull on the cable. Tighten the jam nuts. Repeat on both sides.
6. Close the hopper and cover.
7. Operate the machine and check the brakes for proper operation.

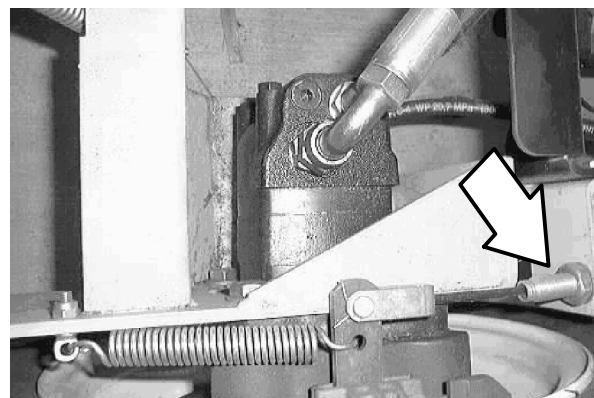

CHASSIS

PARKING BRAKE

The parking brake is activated by a pedal located above the service brake pedal. Pushing on the parking brake will lock the service brake pedal in position. To release the parking brake--press on the service brake pedal.

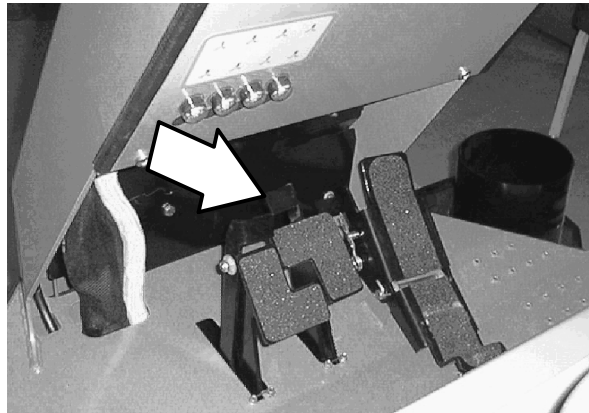

TIRES AND WHEELS

The front and rear tires on the ATLV™ 4300 are pneumatic. The rims are one piece steel tubeless style.

NOTE: Inflate the front tires to 22 psi and the rear tires to (7 psi. standard, 18 psi. optional all terrain tires).

TO REPLACE FRONT TIRE AND WHEEL

FOR SAFETY: Before Leaving Or Servicing Machine; Stop On Level Surface, Set Parking Brake, turn off machine, and remove key.

1. Loosen the four wheel nuts before raising the front end of the machine. **DO NOT** remove the wheel nuts at this point.

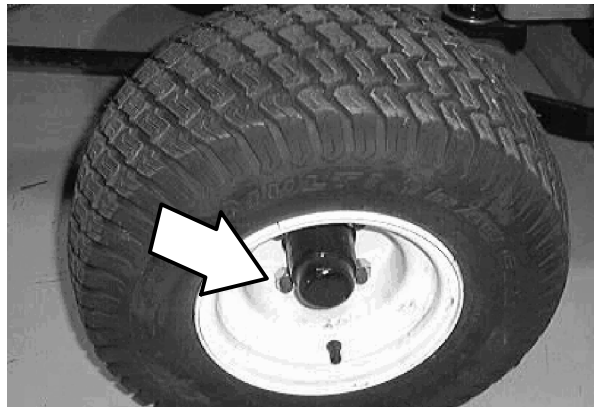

2. Jack up the front of the machine at the indicated jack points. Install jack stands under the machine frame.
3. Finish removing the four wheel nuts. Remove the tire and wheel assembly from the machine.
4. Position the new tire and wheel assembly onto the front axle hub.
5. Reinstall the four wheel nuts and tighten finger tight.
6. Remove the jack stands and lower the machine to the floor.

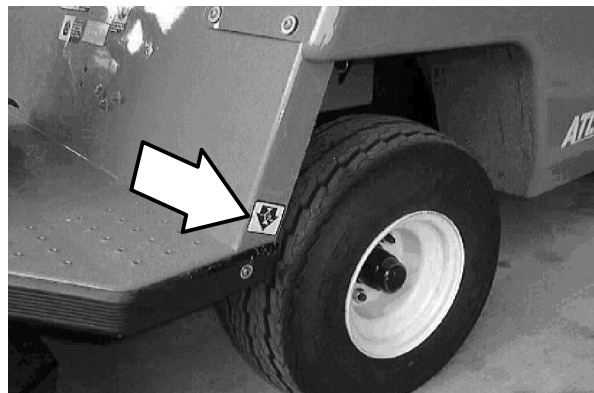

7. Go back and finish tightening the four wheel nuts to 122 - 162 Nm (90 - 120 ft. lb).
8. Check the new tires for wear and rotate every 200 hours of operation.
9. Check the tire pressure every 50 hours of operation.

TO REPLACE REAR TIRE AND WHEEL

FOR SAFETY: Before Leaving Or Servicing Machine; Stop On Level Surface, Set Parking Brake, turn off machine, and remove key.

1. Place blocks in front and back of the front tires.
2. Jack up the rear of the machine at the indicated jack points. Install jack stands under the machine frame.
3. Make sure the parking brake is engaged. Remove the five wheel nuts. Remove the tire and wheel assembly from the machine.
4. Position the new tire and wheel assembly onto the front axle hub.

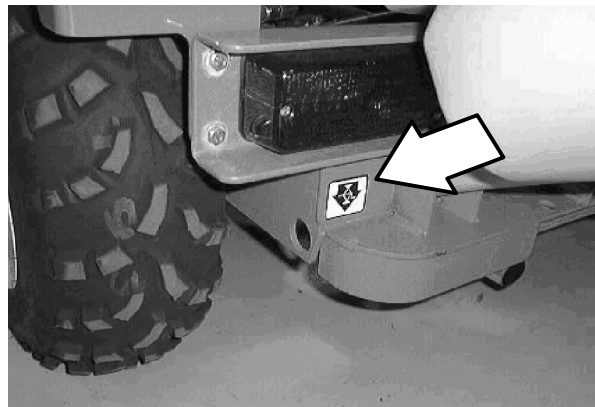

5. Reinstall the five wheel nuts and tighten to 122 - 162 Nm (90 - 120 ft. lb).
6. Remove the jack stands and lower the machine to the floor.
7. Remove the blocks from the front tires.
8. Check the new tires for wear and rotate every 200 hours of operation.
9. Check the tire pressure every 50 hours of operation.



TO ALIGN FRONT TIRES

1. Drive the machine forward with the steering wheel pointed straight ahead.

FOR SAFETY: Before Leaving Or Servicing Machine; Stop On Level Surface, Set Parking Brake, turn off machine, and remove key.

2. Use a tape measure to check the alignment of the front tires. The rear of the front tires should be $1/16''$ to $3/16''$ farther apart than the front of the front tires ("toe-in" condition).
3. If an adjustment is needed--go under the machine on either side and locate the clevis at each end of the steering cylinder.
4. Loosen the jam nut where the ball end is attached to the cylinder clevis.
5. Remove the $.50''$ hex screw and nyloc nut from the clevis and cylinder end. Pull the clevis off the cylinder.

NOTE: Make sure to retain the steel spacers (2 per end) in the end of the cylinder.

6. Three full turns of the clevis on the rod end equals $1/2''$ travel. Make adjustments to both sides equally (this will keep piston travel of the steering cylinder centered on the axle).

NOTE: There should be approximately $3/8''$ of thread sticking through the block on the clevis.

7. Reinstall the clevis onto the end of the cylinder. Reinstall the hardware and tighten to 90 - 117 Nm (65 - 85 ft. lb).
8. Tighten the jam nut where the ball joint is attached to the clevis.
9. Drive the machine forward with the steering wheel pointed straight ahead.
10. Re-check the tire alignment. Re-adjust if necessary.

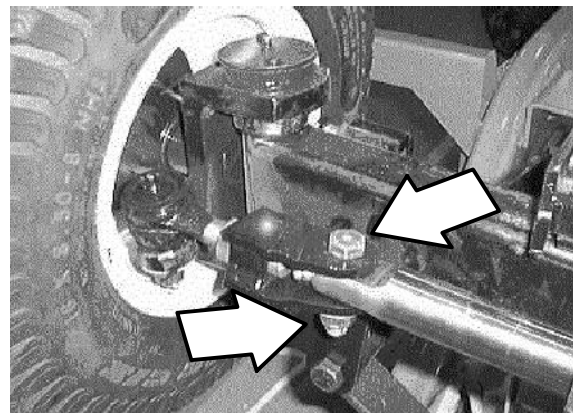
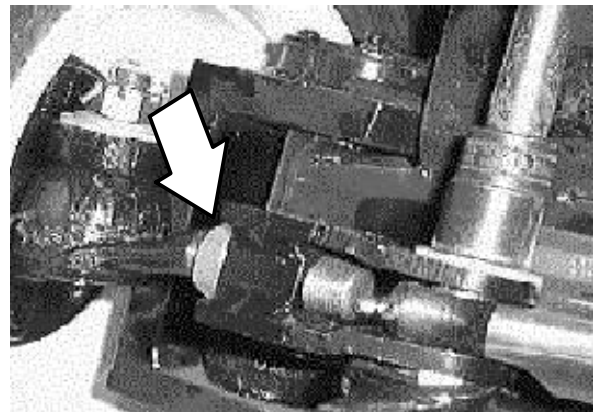
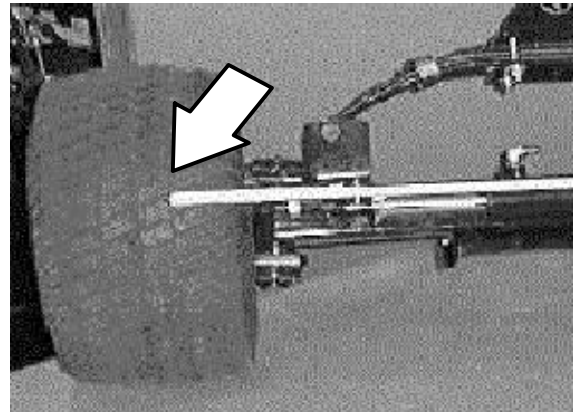
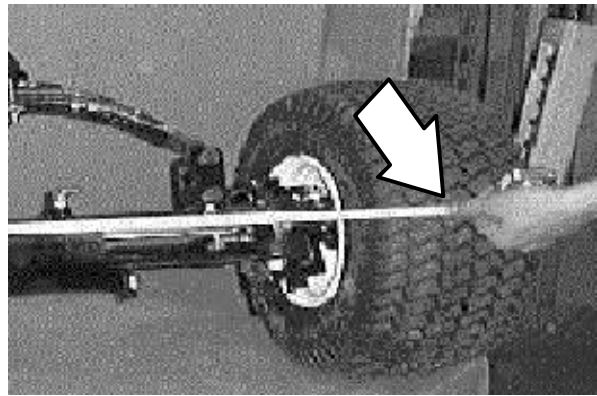

STEERING

The steering system on the ATLV™ 4300 consists of a hydraulic steering wheel motor and a dual action hydraulic cylinder on the front axle. Service instructions for these components can be found in the HYDRAULIC section of this manual.

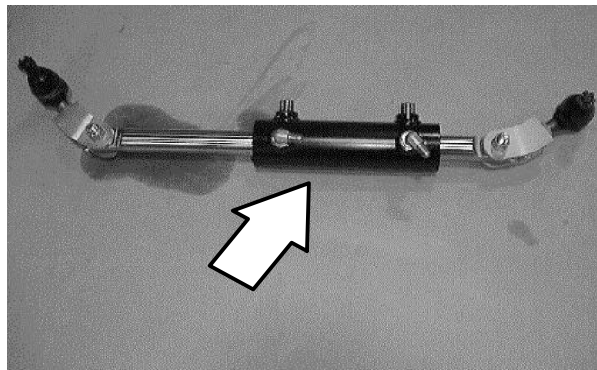
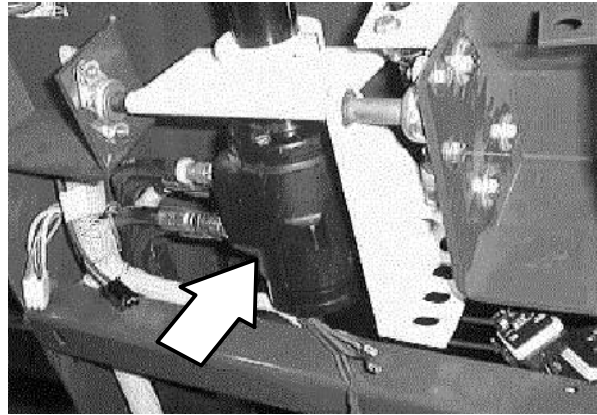

TO SET TURNING RADIUS STOPS

FOR SAFETY: Before Leaving Or Servicing Machine; Stop On Level Surface, Set Parking Brake, turn off machine, and remove key.

1. Jack up the front of the machine at the indicated jack points. Install jack stands under the machine frame.
2. Turn the steering wheel all the way in one direction.
3. Go under the machine and locate the steering stop bolts on each end of the axle assembly on the back side.
4. The wheel axle casting should NOT BE touching the stop bolt. There should be .030" clearance between the head of the stop bolt and the edge of the wheel axle casting.
5. If an adjustment needs to be made, loosen the jam nut on the stop bolt and turn in or out. Hold the bolt from turning and re-tighten the jam nut.
6. Turn the steering wheel all the way the other direction and repeat steps 4 and 5.
7. Remove the jack stands and lower the machine.

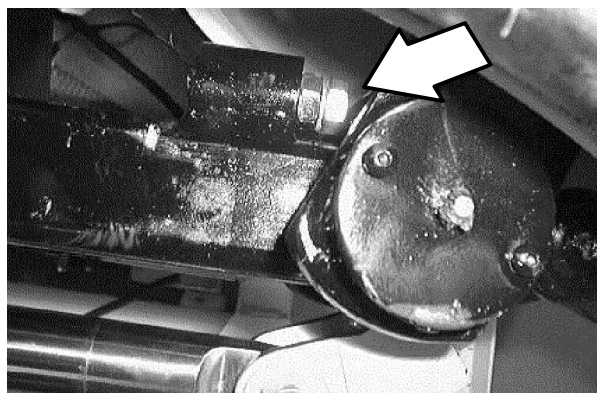
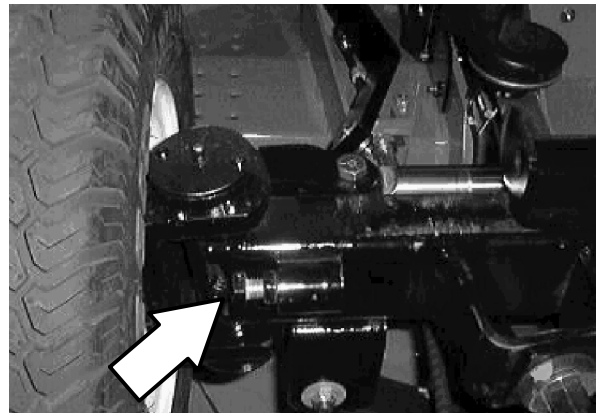

FRONT AXLE

The front axle on the ATLV™ 4300 is a pivoting, spring mounted design. The pivoting design allows the machine to be driven over uneven terrain and still have all four tires contact the ground. The leaf spring provides a comfortable ride.

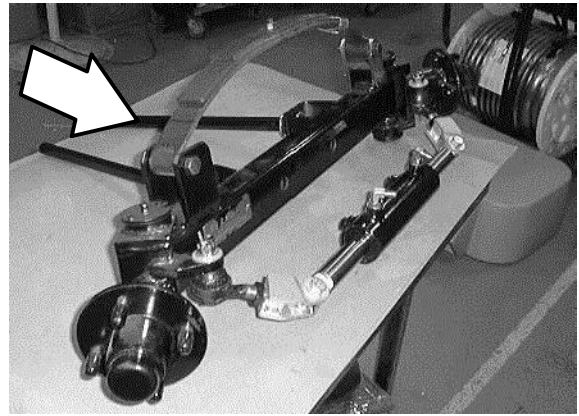

TO REMOVE FRONT AXLE ASSEMBLY

1. Lower the vacuum head. Disconnect the vacuum head from the axle assembly

FOR SAFETY: Before Leaving Or Servicing Machine; Stop On Level Surface, Set Parking Brake, turn off machine, and remove key.

2. Removal of the front axle is easier with the front tires removed.
3. Loosen the eight wheel nuts before lifting the front end of the machine. DO NOT remove the wheel nuts at this point.
4. Jack up the front of the machine at the indicated jack points. Install jack stands under the machine frame.
5. Finish removing the eight wheel nuts. Remove the tire and wheel assemblies from the machine.
6. Remove the three hex screws holding the head lift actuator assembly to the left side of the operator compartment. Let the actuator assembly drop down and out of the way so the pivot pin can be removed.
7. Mark, remove, and cap the two hydraulic hoses leading to the steering cylinder on the front of the axle assembly.

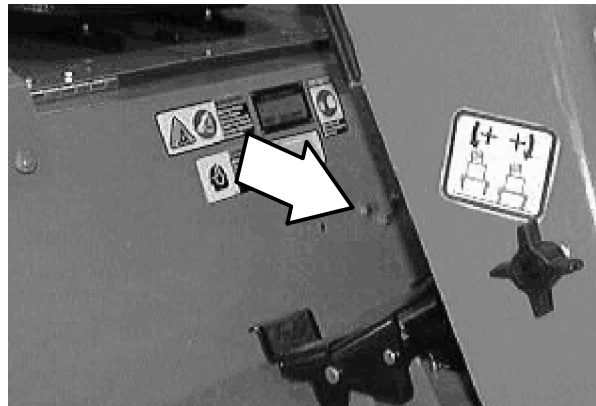
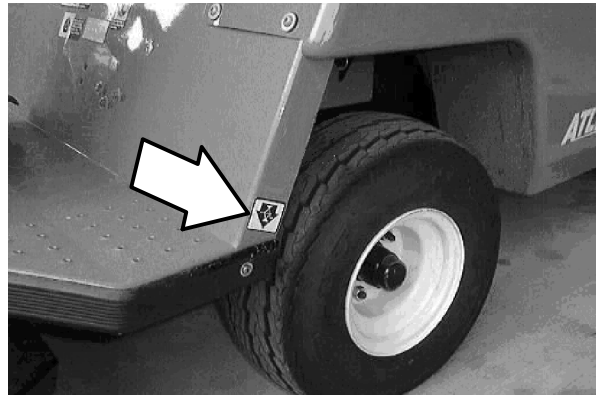

NOTE: Observe hydraulic cleanliness requirements when opening hydraulic lines.

8. The front axle assembly must be supported before any hardware is removed. Use jack stands or a floor jack.

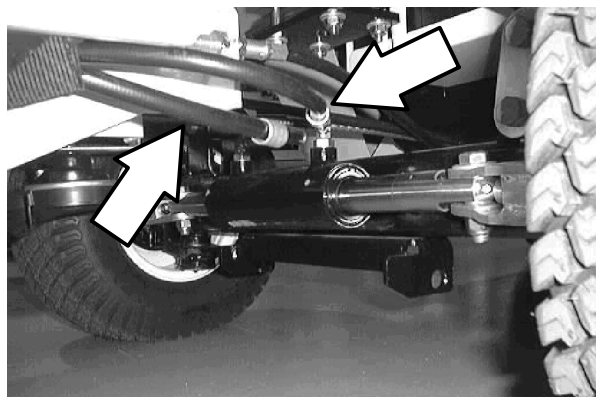

9. Remove the M12 hex screw and washer holding each stabilizer bar to the machine frame.
10. Remove the M8 hex screw and nyloc nut holding the leaf spring pivot pin into the frame. Carefully push the pivot pin toward the front of the machine.

NOTE: Make sure the front axle is supported in some manner.

11. Remove the two nyloc nuts holding the rear facing shackle plate to the left side of the leaf spring. Pull the shackle plate off the two hex screws. Pull the front shackle plate and two screws out the front of the spring and axle.
12. Lift the end of the leaf spring that is disconnected from the axle. Move the axle assembly down and over slowly so the two brake cables and propel cable can be slipped off the end of the axle.
13. Carefully drop the front axle assembly down and out of the machine.

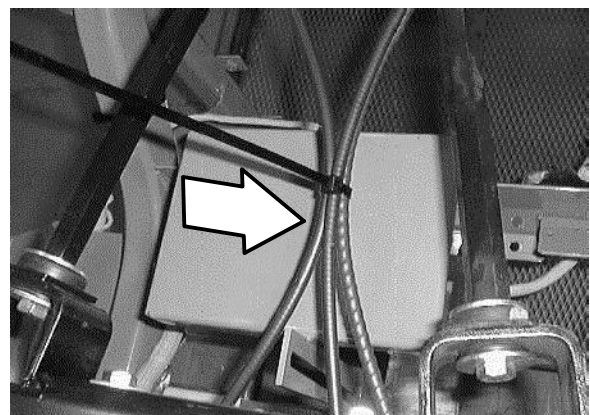
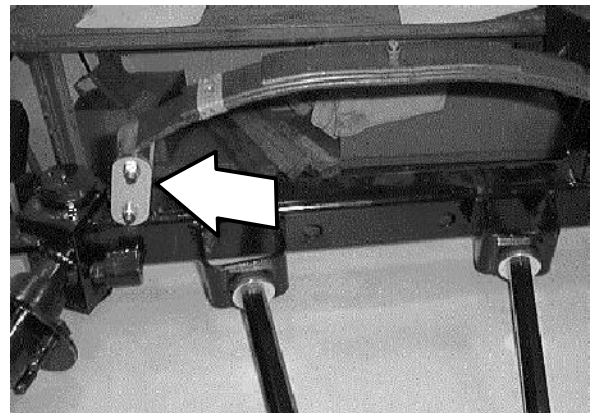
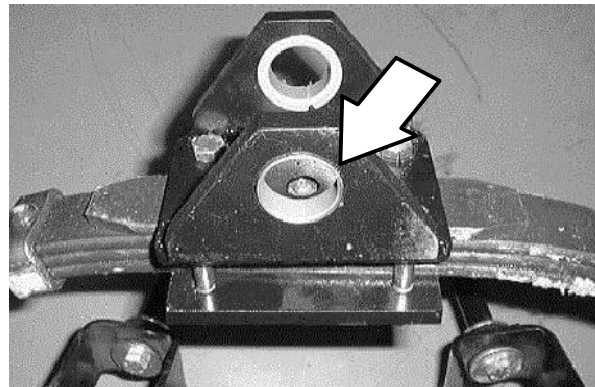
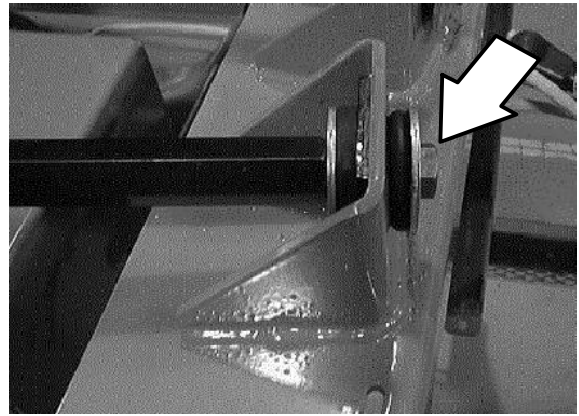

CHASSIS

TO INSTALL FRONT AXLE ASSEMBLY

1. Jack up the front of the machine at the indicated jack points. Install jack stands under the machine frame.
2. Installation of the front axle is easier with the front tires removed.
3. Position the front axle assembly under the machine with the steering cylinder facing the front of the machine and the stabilizer bars pointing to the back of the machine.
4. Use a floor jack to carefully lift the axle into position.

NOTE: Make sure the left side of the leaf spring is disconnected from the axle.

5. Slowly move the axle assembly into position. While doing so, place the two brake cables and propel cable over the top of the axle and below the leaf spring.
6. Reinstall the two shackle plates, two shoulder screws, and two nyloc nuts into the left end of the leaf spring. Tighten the two hex screws with an impact then hit with a hammer to seat knurls.
7. Line up the mount holes in the leaf spring pivot bracket with the mount hole in the machine frame. Install the pivot pin. Install the M8 hex screw and washer and tighten to 18 - 24 Nm (15 - 20 ft.. lb).
8. Position the head lift actuator assembly onto the left side of the operator compartment. Reinstall the hardware and tighten to 18 - 24 Nm (15 - 20 ft. lb).
9. Line up the mount holes in the ends of the two stabilizer bars with the mount hole in the rubber dampners. Install the M12 hex screws and washers. Hand tighten tight.

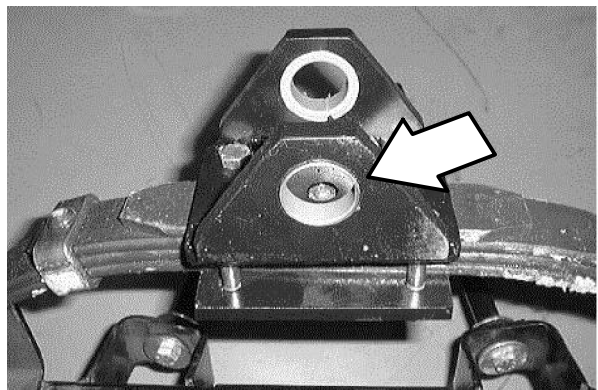
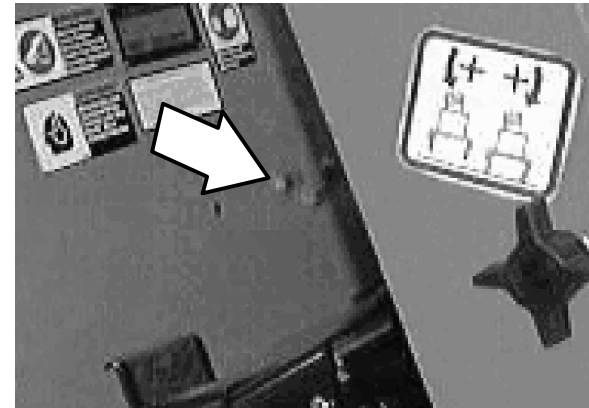
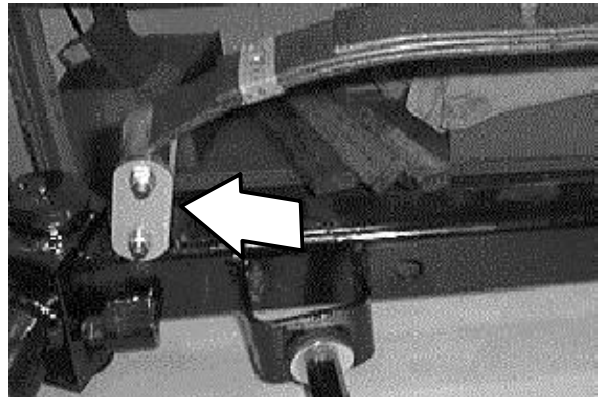
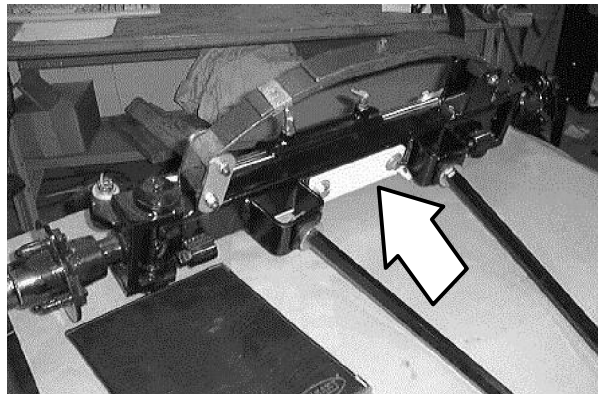

10. Reconnect the two hydraulic hoses to the steering cylinder.

NOTE: Observe hydraulic cleanliness requirements when opening hydraulic lines.

11. Position the front tire and wheel assemblies onto the front axle.
12. Reinstall the eight wheel nuts and tighten finger tight.
13. Remove the jack stands and lower the machine to the floor.
14. Go back and finish tightening the wheel nuts to 122 - 162 Nm (90 - 120 ft. lb).
15. Reconnect the vacuum head to the front axle.
16. Operate the machine and check for proper operation.

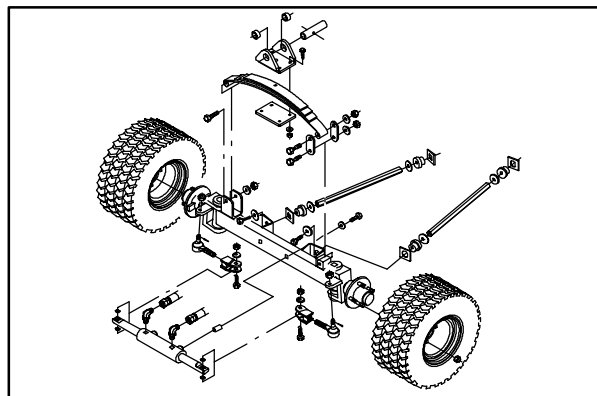
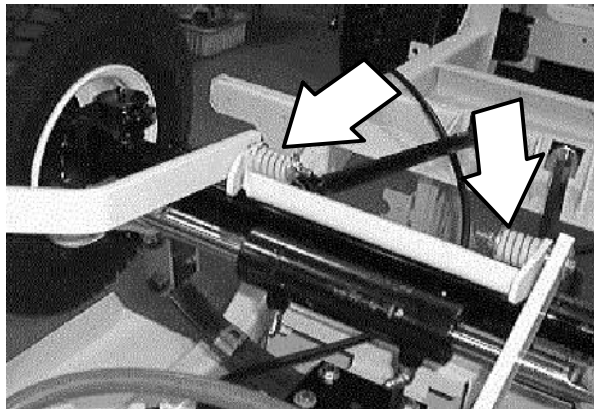
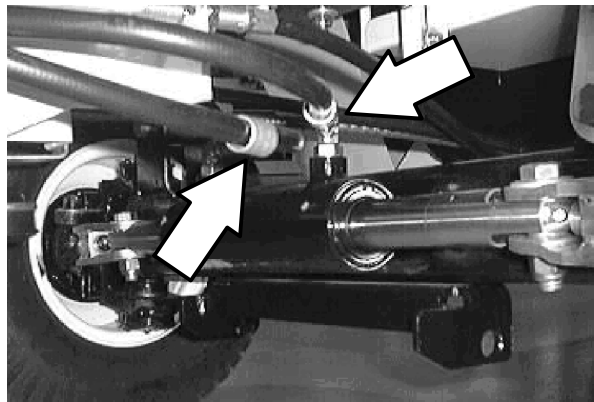
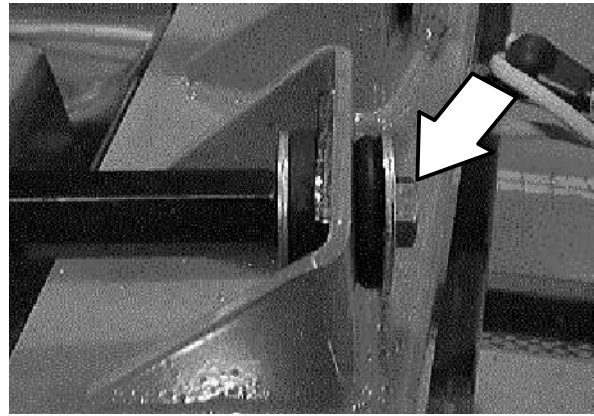

CHASSIS

TO REPLACE FRONT AXLE LEAF SPRING

FOR SAFETY: Before Leaving Or Servicing Machine; Stop On Level Surface, Set Parking Brake, turn off machine, and remove key.

1. Remove the front axle assembly. See TO REMOVE FRONT AXLE ASSEMBLY instructions in this section.
2. Remove four hex screws and nyloc nuts holding the pivot assembly to the top of the leaf spring. Remove the pivot assembly.
3. Remove the hex screws (1 bolt on right side, 2 on left side) and nyloc nuts holding the ends of the leaf spring to the front axle assembly. The hex screws may need to be hammered out of the mount holes because of a knurl on the bolt shoulder.
4. Remove the shackle plates from the left side of the leaf spring.
5. Remove the leaf spring from the axle assembly.
6. Position the new leaf spring onto the axle assembly in the same orientation as the old leaf spring.
7. Install the two shackle plates, two hex screws, and two nylocs to the left side of the new leaf spring. Place the nylocs on the back side.
8. Install the hex screw and nyloc to the right side of the new leaf spring. Place the nyloc on the back side.
9. Tighten all the hardware with an impact then hit the bolt with a hammer to seat the knurl.
10. Reinstall the axle assembly. See TO INSTALL FRONT AXLE ASSEMBLY instructions in this section.

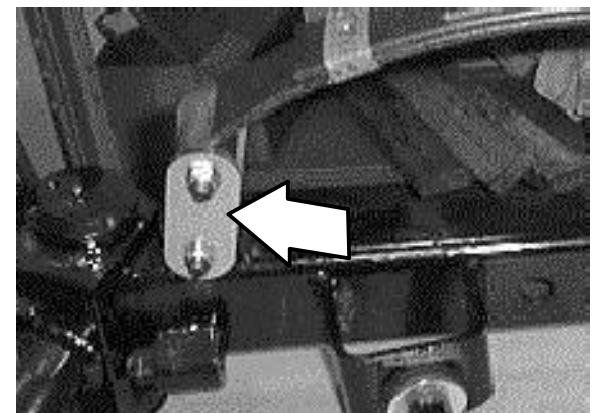
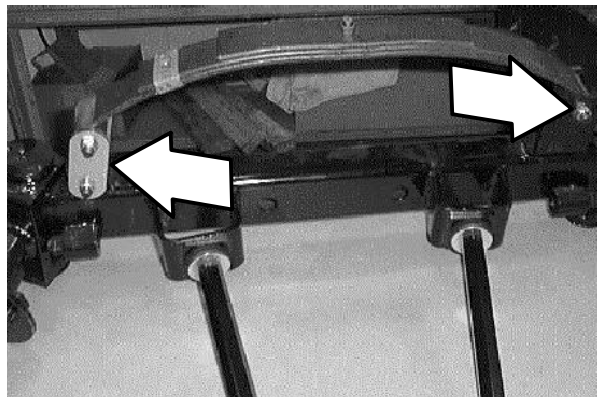
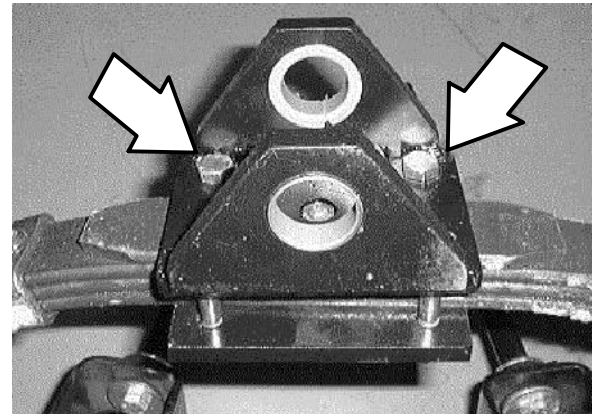
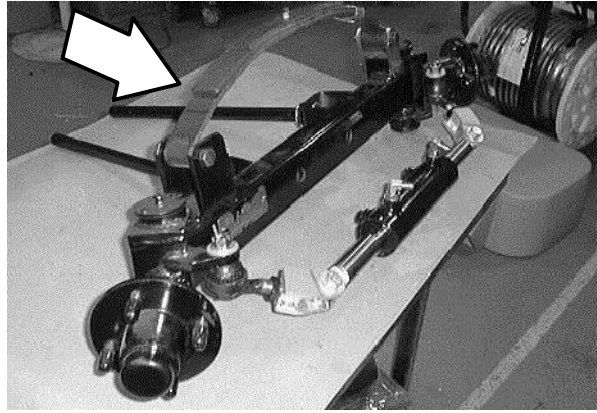

TO REPLACE FRONT AXLE ROD END

FOR SAFETY: Before Leaving Or Servicing Machine; Stop On Level Surface, Set Parking Brake, turn off machine, and remove key.

1. Loosen the four wheel nuts before raising the front end of the machine. **DO NOT** remove the wheel nuts at this point.
2. Jack up the front of the machine at the indicated jack points. Install jack stands under the machine frame.
3. Finish removing the four wheel nuts. Remove the tire and wheel assembly from the machine.
4. Go under the machine on either side and locate the clevis at each end of the steering cylinder.
5. Loosen the jam nut where the rod end is attached to the cylinder clevis.
6. Remove the cotter pin from the castle nut on top of the rod end. Remove the castle nut.
7. Use a pickle fork to pop the rod end out of the steering arm on the axle assembly.
8. Unscrew the rod end from the steering cylinder clevis. Note orientation of rod end to clevis.
9. Install the new rod in the same orientation as the old one. **Leave 3/8" of the rod end threads sticking through the clevis block.** Leave the jam nut loose for now.
10. Position the rod end into the bottom of the axle steering arm. Install the castle nut and tighten tight, then tighten to the next cotter pin cross hole. Install the cotter pin.
11. Tighten the jam nut on the new rod end.
12. Reinstall the four wheel nuts and tighten finger tight.
13. Remove the jack stands and lower the machine to the floor.
14. Go back and finish tightening the four wheel nuts to 122 - 162 Nm (90 - 120 ft. lb).
15. Check the front wheel alignment. See **TO ALIGN FRONT TIRES** instructions in this section.

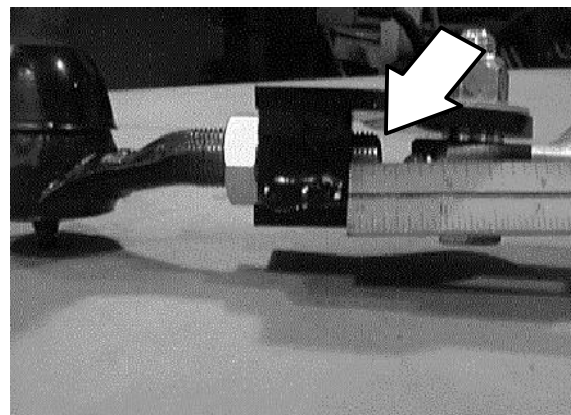
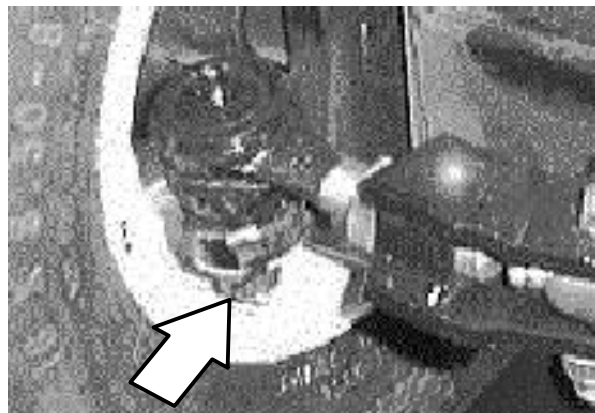

CHASSIS

PROPEL CABLE

The model ATLV™ 4300 is hydrostatically driven. The foot pedal in the operators compartment is connected to a push/pull cable that in turn is connected to the propel pump arm.

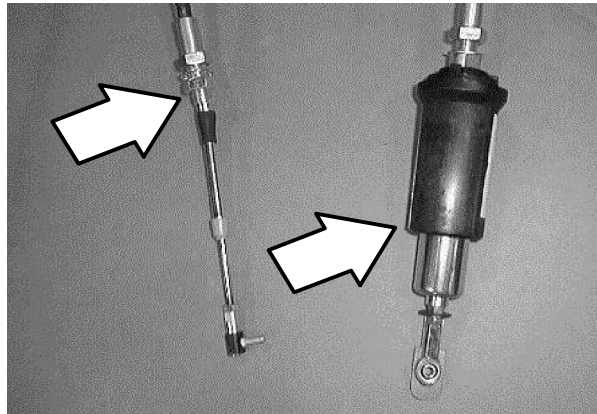

TO REPLACE PROPEL CABLE

FOR SAFETY: Before Leaving Or Servicing Machine; Stop On Level Surface, Set Parking Brake, turn off machine, and remove key.

1. Go under the machine at the front right corner. Locate the propel cable ball joint on the bottom of the propel pedal.
2. Remove the nyloc nut holding the ball joint to the pedal. Pull the ball joint out of the mount hole.

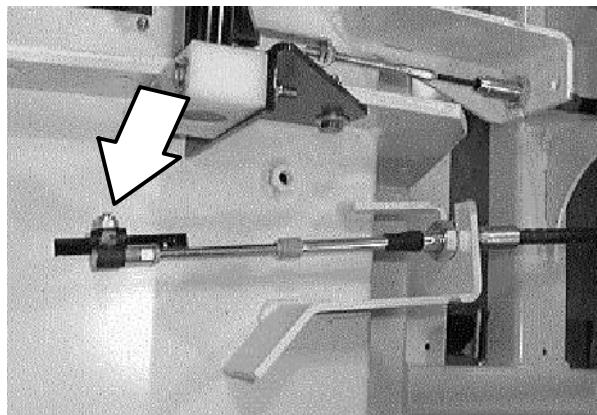

3. Loosen the large jam nuts on the propel cable where it is attached to the machine frame. Pull the cable out of the slot.
4. Follow the propel cable back and remove any plastic ties that are holding the cable to the frame or other cables.
5. Open the hopper cover and tilt the hopper back.
6. Open the top engine cover.
7. Remove the five pan screws holding the rear engine cover to the machine. Remove the cover.

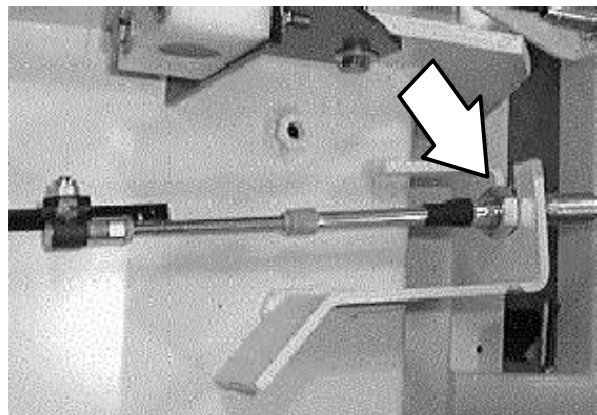

8. Locate the propel cable and hydroback on the back side of the propel pump and engine.
9. Cut the plastic tie. Remove the M6 hex screw and nyloc nut from the ball joint where it attaches to the propel pump arm. Retain the two spacers.
10. Loosen the one large jam nut holding the propel cable/hydroback to the mount bracket. Pull the assembly out of the mount slot. Remove the propel cable/hydroback assembly from the machine.

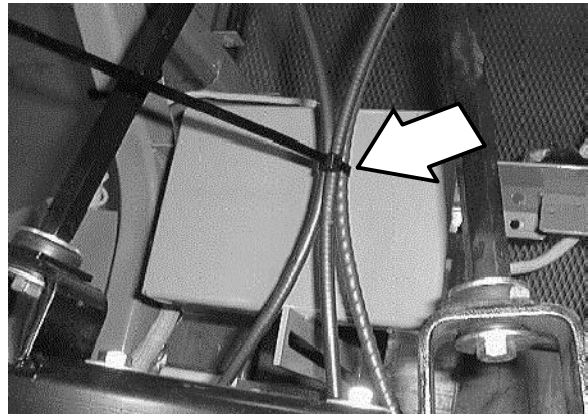

NOTE: Note the how the cable is routed in the machine.

11. Remove and retain the clevis and safety clip from the hydroback end of the propel cable.
12. Loosen the jam nut at the back of the hydroback. Screw the hydroback off the propel cable. Retain the hydroback.
13. Remove and retain the ball joint from the other end of the propel cable. Discard the old propel cable.
14. Locate the end of the new propel cable with 1.5 inches of .25-28 thread. Remove the small cable nut and one large jam nut from this end of the cable. Position the hydroback onto this end of the cable (large end first).
15. Spin the large jam nut down until it bottoms out on the cable housing. Spin the hydroback down until there is .50 inch of threads between the large jam nut and the end of the hydroback.
16. Install the one small cable nut on the other side of the hydroback and lock it down. Install the safety clip, rubber washer, and the second cable nut. Lock the second nut against the safety clip and the first cable nut. Spin the clevis down against the second cable nut. Lock the clevis to the nut.

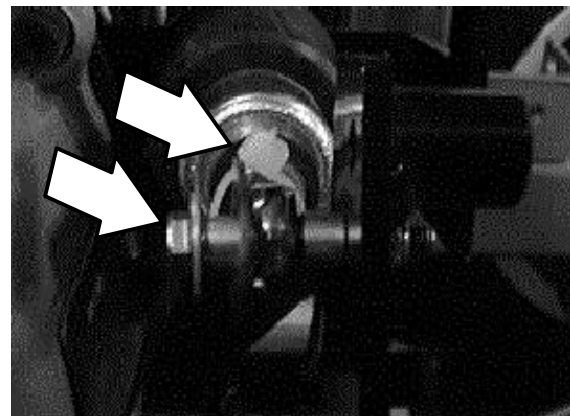
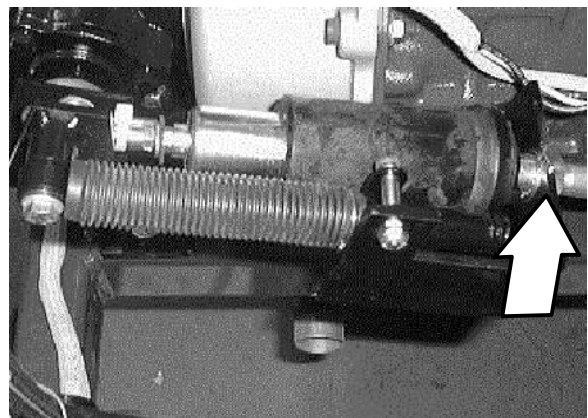

CHASSIS

17. Go to the other end of the new propel cable (1 inch of thread) and install the small cable nut.
18. Turn the small nut down until there is .25 inch of threads left on the cable. Place a small amount of blue loctite (242) onto the threads of the cable.
19. Install the ball joint and spin down against the small cable nut. Lock the nut against the ball joint.
20. Position the new cable assembly into the machine. Route the cable in the machine in the same orientation as the old one.

NOTE: It is very important that the new cable follows the same routing as the old one.

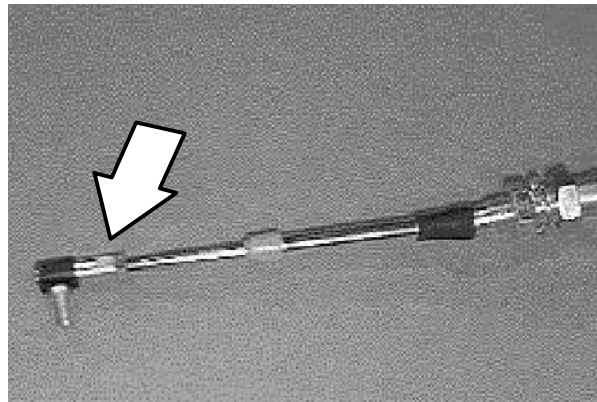
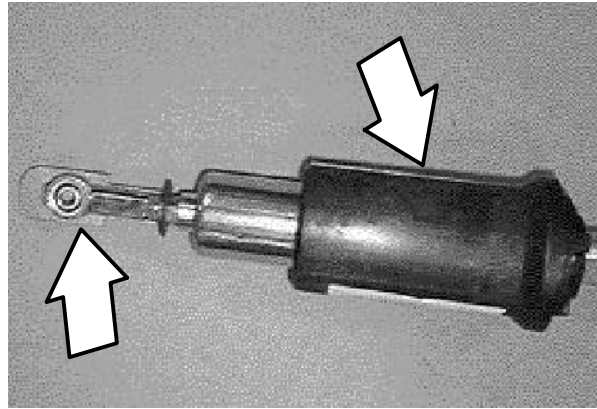

21. Position the hydroback into the mount bracket, on the back side of the propel pump. Tighten the jam nut. Make sure the internal lock washer is on the hydroback side of the mount bracket.
22. Install the hex screw and two spacers in the clevis end of the cable and into the propel pump arm. Tighten to 8 - 10 Nm (6 - 8 ft. lb). Reinstall a plastic tie.
23. Go under the front of the machine and position the propel cable into the mount slot on the machine frame. Leave the jam nuts loose for now.
24. Place the ball joint into the hole in the bottom of the propel pedal. Tighten the nyloc nut to 8 - 10 Nm (6 - 8 ft. lb).

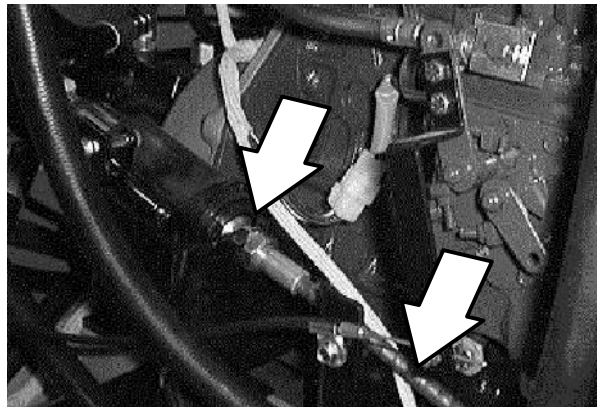

25. Set the heel of the foot pedal to 1-1/8 inch from the floor plate. Tighten the jam nuts on the propel cable.
26. The neutral centering will have to be set at this point. See TO ADJUST PROPEL NEUTRAL instructions in this section.

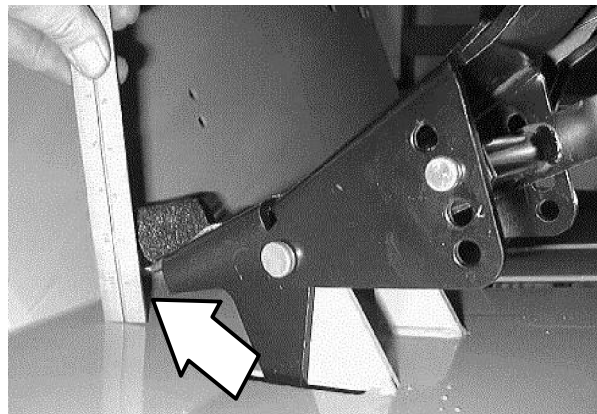
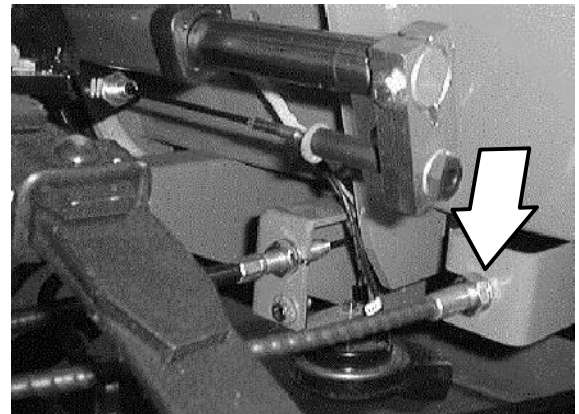
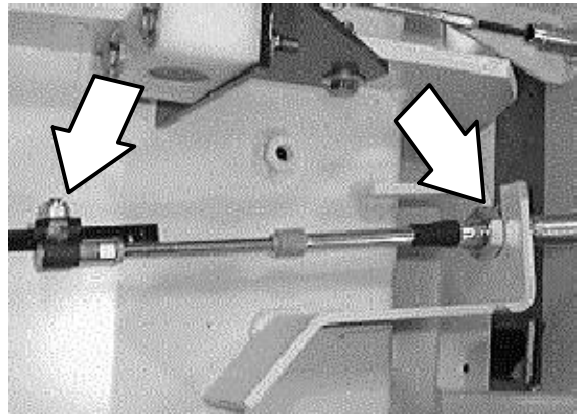

CHASSIS

TO REPLACE PROPEL HYDROBACK

FOR SAFETY: Before Leaving Or Servicing Machine; Stop On Level Surface, Set Parking Brake, turn off machine, and remove key.

1. Open the hopper cover and tilt the hopper back.
2. Open the top engine cover.
3. Remove the five pan screws holding the rear engine cover to the machine. Remove the cover.
4. Locate the propel cable and hydroback on the back side of the propel pump and engine.
5. Cut the plastic tie. Remove the M6 hex screw and nyloc nut from the ball joint where it attaches to the propel pump arm. Retain the two spacers.
6. Loosen the one large jam nut holding the propel cable/hydroback to the mount bracket. Pull the assembly out of the mount slot. Remove the propel cable/hydroback assembly from the machine.

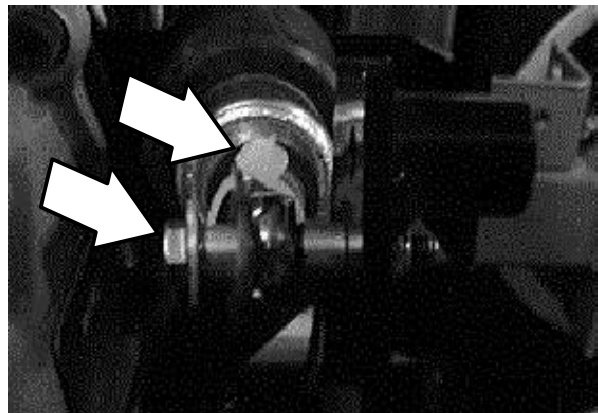
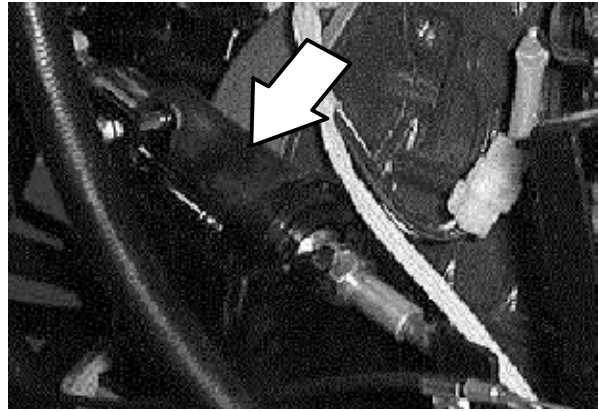

NOTE: Note how the cable is routed in the machine.

7. Remove and retain the clevis and safety clip from the hydroback end of the propel cable.
8. Loosen the jam nut at the back of the hydroback. Screw the hydroback off the propel cable. Discard the hydroback.
9. Position the new hydroback onto the end of the cable (large end first).

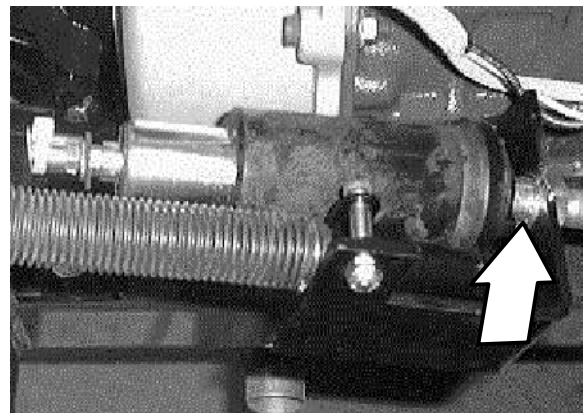

10. Spin the large jam nut down until it bottoms out on the cable housing. Spin the new hydroback down until there is .50 inch of threads between the large jam nut and the end of the hydroback.
11. Install the one small cable nut on the other side of the hydroback and lock it down. Install the safety clip, rubber washer, and the second cable nut. Lock the second nut against the safety clip and the first cable nut. Spin the clevis down against the second cable nut. Lock the clevis to the nut.

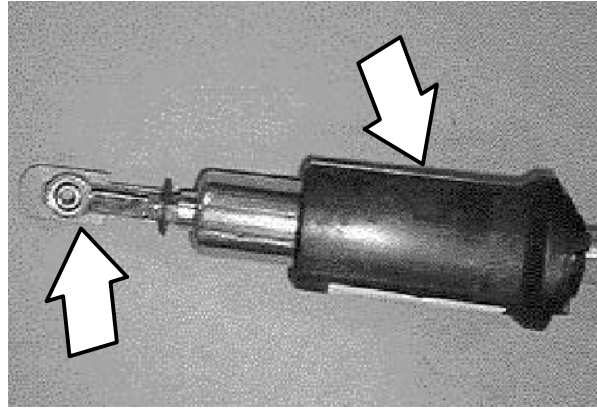

12. Position the new hydroback into the mount bracket. on the back side of the propel pump. Tighten the jam nut. Make sure the internal lock washer is on the hydroback side of the mount bracket.
13. Install the hex screw and two spacers in the clevis end of the cable and into the propel pump arm. Tighten to 8 - 10 Nm (6 - 8 ft. lb). Reinstall a plastic tie.
14. The neutral centering will have to be set at this point. See TO ADJUST PROPEL NEUTRAL instructions in this section.

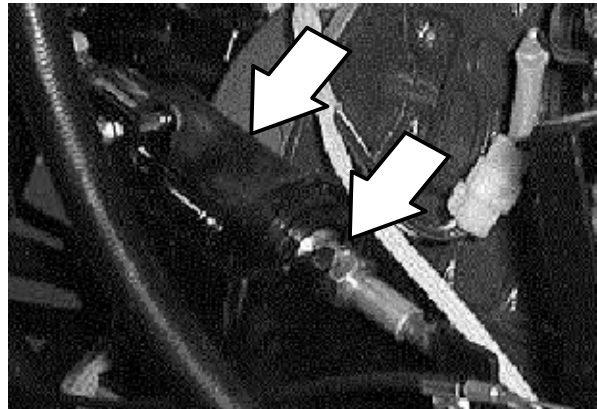

TO SET TRAVEL SPEEDS

FOR SAFETY: Before Leaving Or Servicing Machine; Stop On Level Surface, Set Parking Brake, turn off machine, and remove key.

1. Go to the operators compartment and locate the two hex screws and jam nuts at the front and rear of the propel pedal.
2. Start with the bolt under the rear (heel) portion of the propel pedal set at 1-1/8 inch from the top of the bolt head to the floor of the operators compartment. This should give about 4 mph.
3. Use the bolt under the front (toe) portion of the propel pedal to set the maximum forward speed to 16 mph.
4. Loosen the jam nut and screw the bolt up or down to make any adjustments. Retighten the jam nut after the speed adjustment has been made.

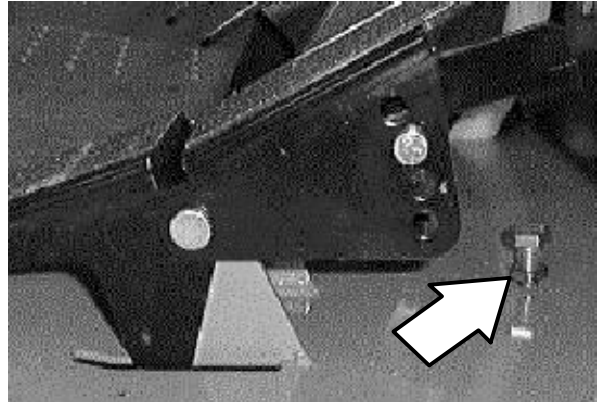
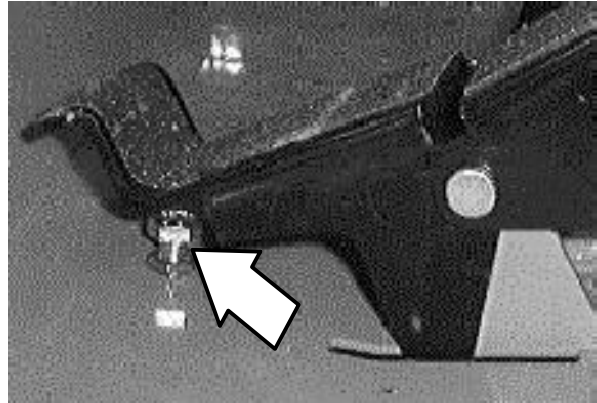

TO ADJUST PROPEL NEUTRAL

FOR SAFETY: Before Leaving Or Servicing Machine; Stop On Level Surface, Set Parking Brake, turn off machine, and remove key.

1. Open the hopper cover and tilt the hopper back.
2. Open the top engine cover.
3. Remove the five pan screws holding the rear engine cover to the machine. Remove the cover.

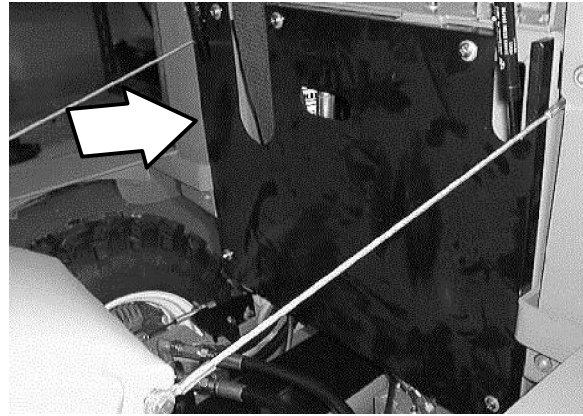

NOTE: The rear wheels must be off the ground when adjusting the neutral centering.

4. Place blocks in front and back of the front tires.
5. Jack up the rear of the machine at the indicated jack points. Install jack stands under the machine frame.
6. Locate the propel pump directional arm hub on the back side of the pump.
7. Loosen the two outside hex screws on the hub. DO NOT loosen the cap screw in the center of the hub. Place an allen wrench in the cap screw (this will be used to rotate the hub).
8. Start the machine and observe the rear tires. If they are not turning--no adjustment is needed and the hardware can be tightened. If the tires are rotating--an adjustment is needed. Go to the next step.
9. Rotate the allen wrench until the tires are stationary. Hold the allen wrench so the hub does not move. Tighten the two outside hex screws. Re-observe the rear tires for rotation. Repeat step if necessary.
10. Lower the machine and reinstall the rear engine cover.
11. Operate the machine and check the propel for proper operation.

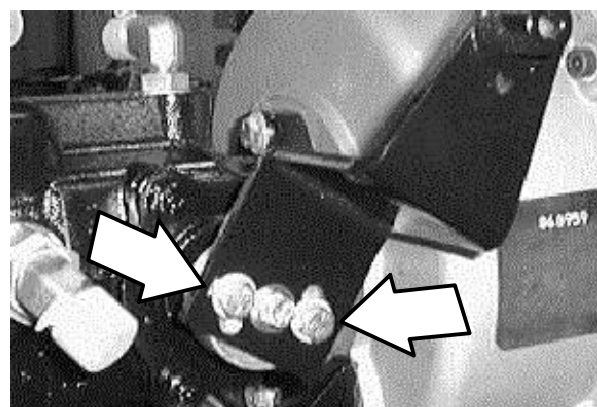
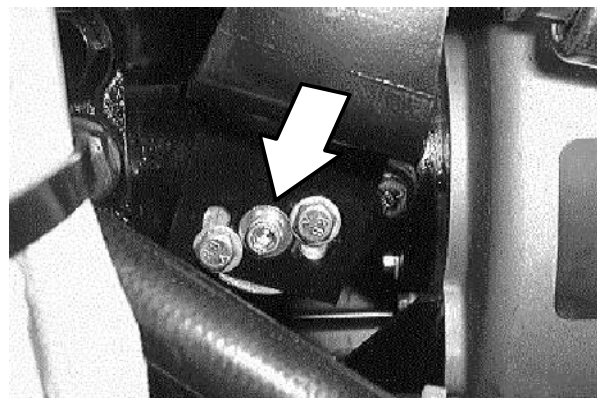
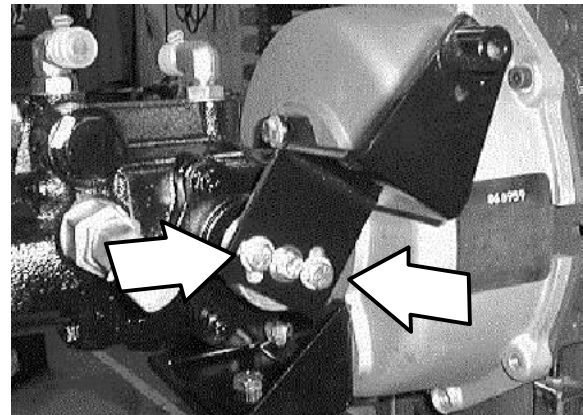

CONTENTS

	Page
INTRODUCTION	3-3
DEBRIS HOPPER	3-4
TO ADJUST HOPPER STOP BRACKET	3-4
TO ADJUST HOPPER LEVEL BRACKETS	3-5
TO ADJUST HOPPER COVER PIVOT BRACKETS	3-6
SKIRTS	3-7
TO REPLACE VACUUM HEAD REAR SKIRT	3-7
TO REPLACE VACUUM HEAD FRONT SKIRT	3-8
VACUUM HEAD	3-9
TO REPLACE VACUUM HEAD ACTUATOR LIFT CABLE	3-9
TO REPLACE VACUUM HEAD SECONDARY LIFT CABLES	3-12
TO ADJUST VACUUM HEAD ACTUATOR LIFT CABLE	3-14
VACUUM FAN	3-15
TO REPLACE VACUUM FAN IMPELLER	3-15
TO REPLACE VACUUM FAN IMPELLER SCREEN	3-18
MACHINE TROUBLESHOOTING	3-19

INTRODUCTION

This section includes information on the vacuuming operation. The vacuum head collects debris which in turn is deposited in the hopper using the suction created by the vacuum fan. The vacuum fan pulls air from the vacuum head, through the hopper, and out the back of the hopper.

DEBRIS HOPPER

The hopper is plastic and is located behind the operators compartment. Debris is deposited into the hopper from the vacuum chamber above. With the hopper cover raised, the hopper body can be tilted back to assist in dumping and for access to the components under the hopper.

TO ADJUST HOPPER STOP BRACKET

FOR SAFETY: Before Leaving Or Servicing Machine; Stop On Level Surface, Set Parking Brake, turn off machine, and remove key.

1. Raise the hopper cover and tilt the hopper back.
2. Locate the hopper stop bracket on the bottom right side of the hopper.
3. The hopper stop bracket should contact and then trip the spring pivot.
4. If the hopper stop bracket does not contact then trip the spring pivot, the stop bracket needs to be adjusted.
5. Loosen the hardware holding the stop bracket to the bottom of the hopper.
6. Move the stop bracket up or down so it contacts and trips the spring pivot. Tighten the hardware to 18 - 24 Nm (15 - 20 ft. lb).
7. Pivot the hopper forward and backward, make sure the bracket is contacting the pivot spring before the hopper is tilted all the way back.

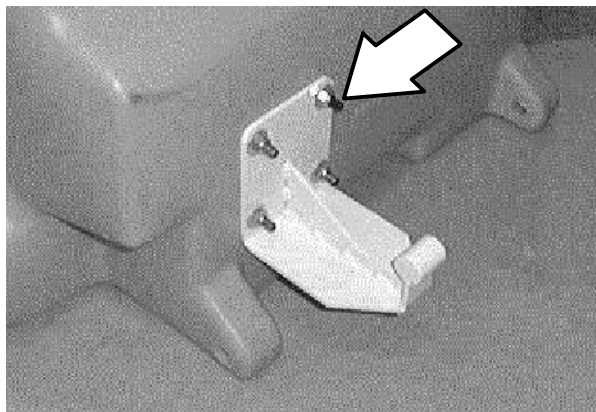
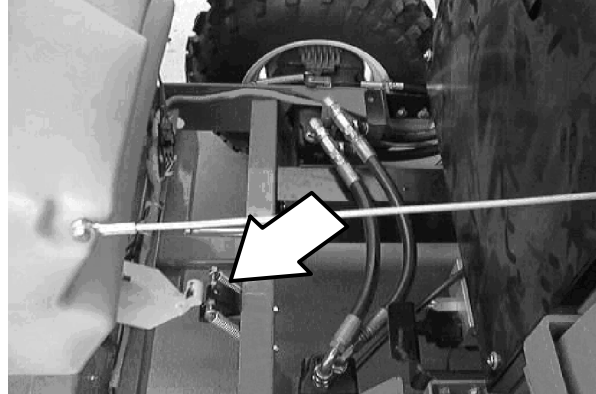

TO ADJUST HOPPER LEVEL BRACKETS

FOR SAFETY: Before Leaving Or Servicing Machine; Stop On Level Surface, Set Parking Brake, turn off machine, and remove key.

1. Raise the hopper cover and tilt the hopper back.
2. Locate the hopper level brackets on each side of the frame, just in front of the drive motors.
3. The hopper level brackets should contact the bottom of the hopper when the hopper is in a level position. The lip seal of the hopper must contact the lip of the hopper cover for proper operation of the vacuum system.
4. If the hopper is not level with the hopper cover, the level brackets must be adjusted.
5. Loosen the two hex screws holding the level bracket to each side of the frame.
6. Move the level brackets up or down until the hopper and hopper cover seal evenly with each other. Re-tighten the hardware to 18 - 24 Nm (15 - 20 ft. lb).
7. Open and close the hopper cover. Check for proper sealing of the cover to hopper seal.

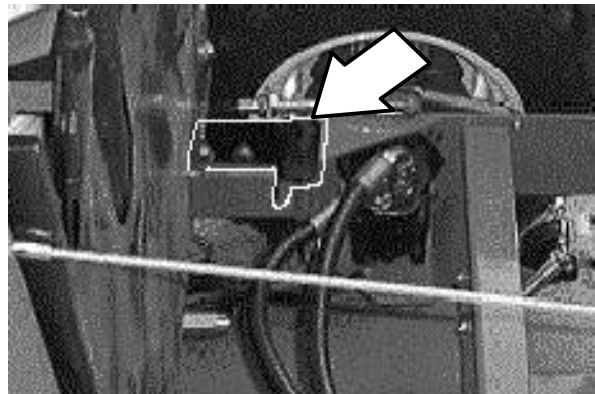
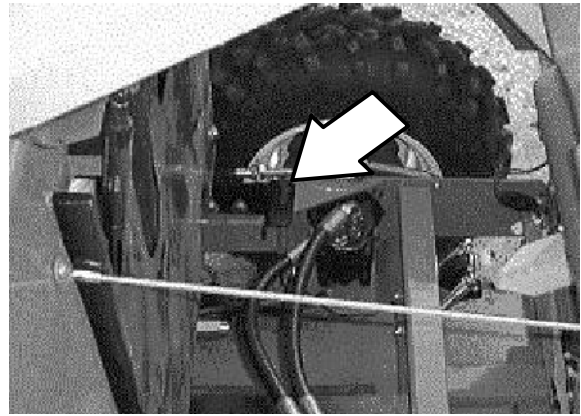

VACUUMING

TO ADJUST HOPPER COVER PIVOT BRACKETS

FOR SAFETY: Before Leaving Or Servicing Machine; Stop On Level Surface, Set Parking Brake, turn off machine, and remove key.

1. The lip seal of the hopper must contact the lip of the hopper cover for proper operation of the vacuum system.
2. If the hopper cover is not level with the hopper, the pivot brackets must be adjusted.
3. Raise the hopper cover and tilt the hopper back.
4. Loosen the hex screws holding the pivot brackets to each front side of the hopper cover.
5. Move the front of the hopper cover up or down until the hopper and hopper cover seal evenly with each other. Re-tighten the hardware to 18 - 24 Nm (15 - 20 ft. lb).
6. Open and close the hopper cover. Check for proper sealing of the cover to hopper seal.

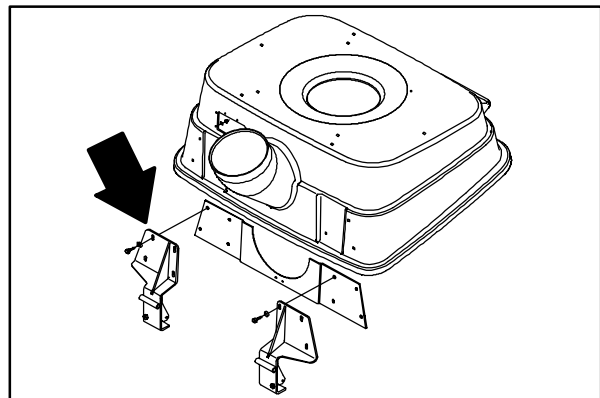
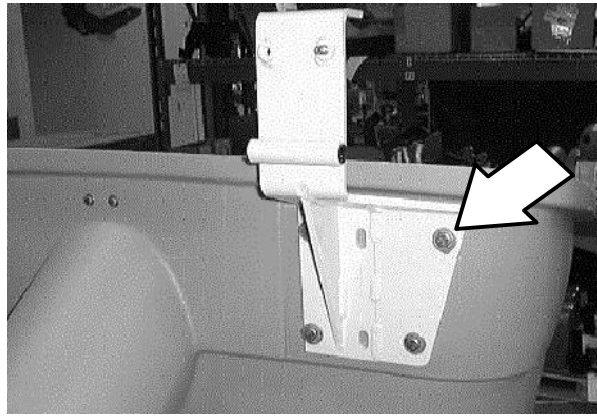

SKIRTS

The vacuum head on the model ATLV™ 4300 is equipped with front and rear rubber skirts. These skirts allow debris to enter the vacuum head chamber, move through the vacuum hose, and be deposited into the hopper. The vacuum head skirts need to be in place and in good condition for optimal vacuuming performance.

TO REPLACE VACUUM HEAD REAR SKIRT

FOR SAFETY: Before Leaving Or Servicing Machine; Stop On Level Surface, Set Parking Brake.

1. The vacuum head should be in the raised position to replace skirts.
2. Remove the three hex screws holding the **left hand** skirt retainer to the left side of the vacuum head.
3. Remove the cotter pin and washer holding the edge roller wheel to the mount pin. Pull the wheel off the pin.
4. Remove the two hex screws holding the **right hand** skirt retainer to the vacuum head frame.
5. Pull the rear skirt off the vacuum head. Discard the rubber skirt.
6. Position the new rear vacuum head skirt on the back of the vacuum head. *NOTE: The notched end of the blade is positioned opposite the tube end of the head (left side).*
7. Reinstall the **right hand** side retainer first. Reinstall the two hex screws. Leave loose for now.
8. Reinstall the **left hand** side retainer second. Reinstall the three hex screws. Make sure the skirt is positioned over all of the tabs.
9. Tighten the corner bolts first, then the front bolts, then the center bolt.
10. Reinstall the edge roller wheel onto the mount pin. Reinstall the cotter pin and washer.
11. Operate the machine and check the vacuum head for proper operation.

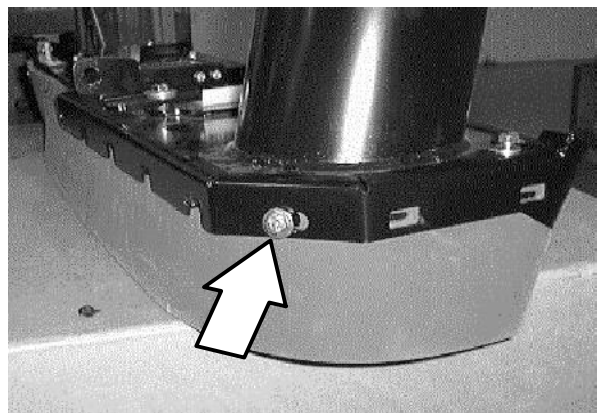
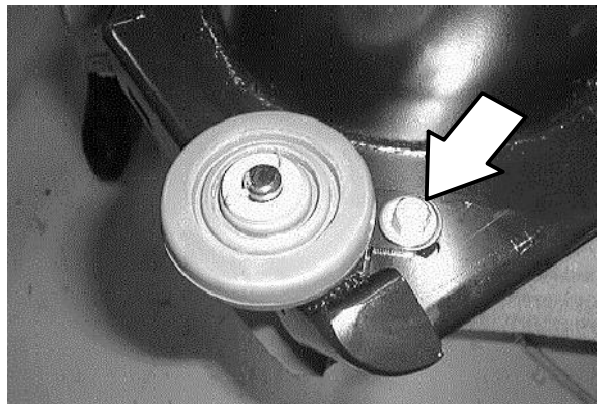
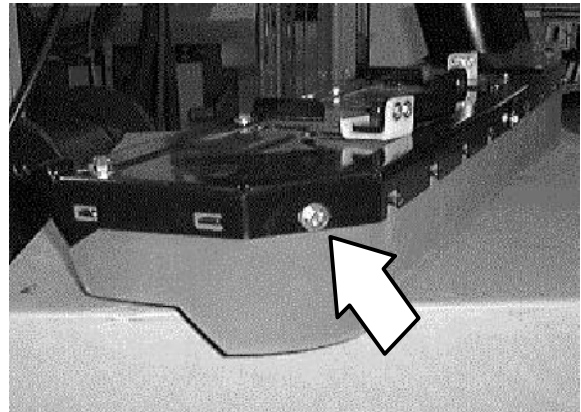
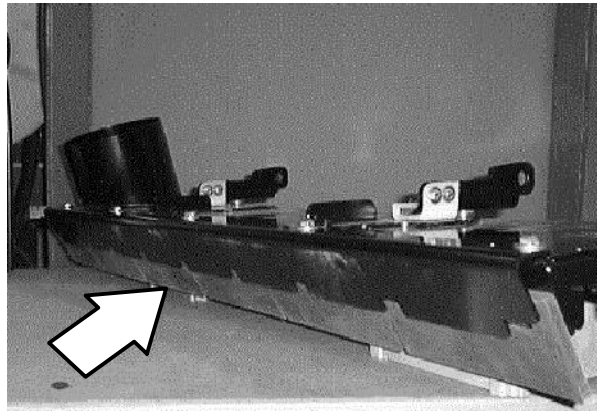

VACUUMING

TO REPLACE VACUUM HEAD FRONT SKIRT

FOR SAFETY: Before Leaving Or Servicing Machine; Stop On Level Surface, Set Parking Brake.

1. The vacuum head rear skirt retainers must be removed before the front skirt can be changed. See TO REPLACE VACUUM HEAD REAR SKIRT instructions in this section.
2. Remove the five hex screws holding the skirt retainer to the front of the vacuum head.
3. Remove the cotter pin and washer holding the edge roller wheel to the mount pin. Pull the wheel off the pin.
4. Remove the retainer from the vacuum head. Pull the skirt off the retainer tabs. Discard the rubber skirt.
5. Position the new front skirt onto the front retainer tabs.
6. Position the skirt and retainer assembly onto the front of the vacuum head. Reinstall the five hex screws and washers. Tighten to 18 - 24 Nm (15 - 20 ft. lb).
7. Reinstall the rear skirt and retainers. See TO REPLACE VACUUM HEAD REAR SKIRT instructions in this section.
8. Reinstall the edge roller wheel onto the mount pin. Reinstall the cotter pin and washer.
9. Operate the machine and check the vacuum head for proper operation.

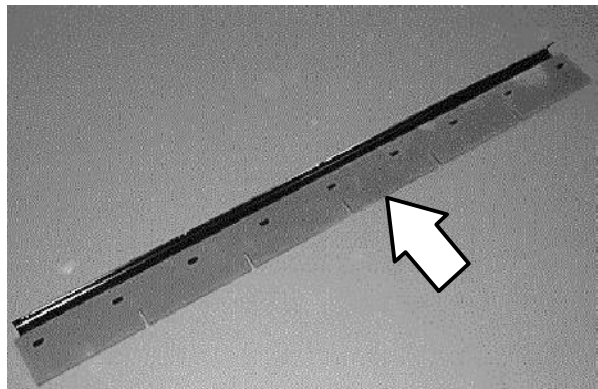
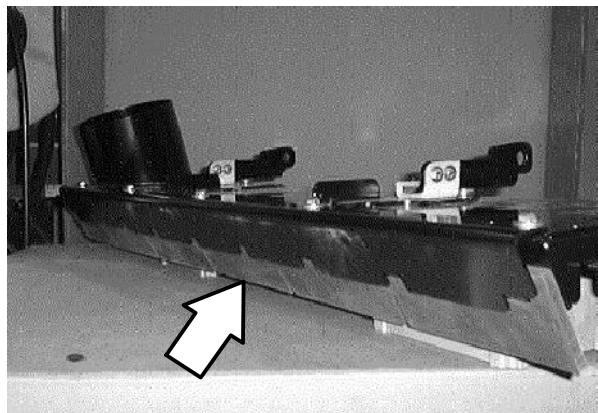
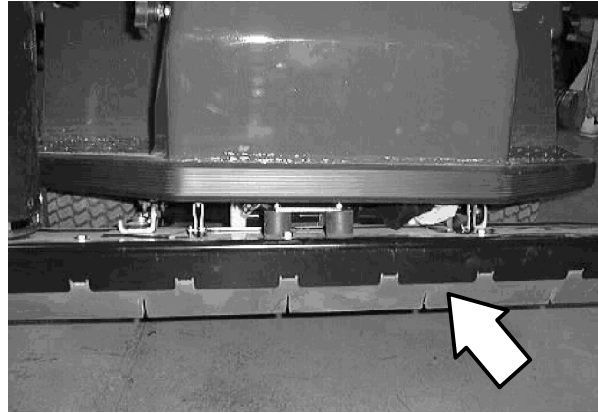

VACUUM HEAD

The vacuum head is positioned at the front of the machine. Airflow from the vacuum fan is routed to the vacuum head through the large, clear debris tube. The vacuum head is raised and lowered with a lift actuator and cable. The knob on the front, right side of the machine is used to control how far down the head is allowed to travel.

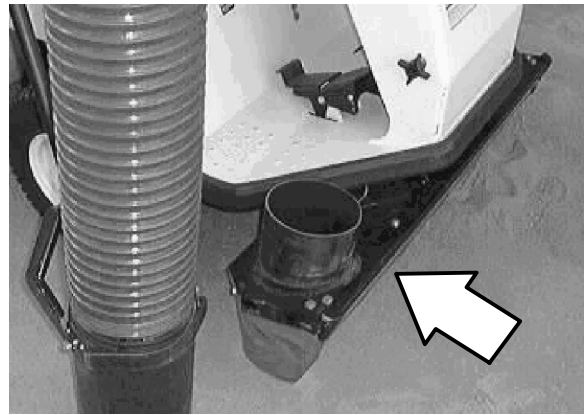

TO REPLACE VACUUM HEAD ACTUATOR LIFT CABLE

FOR SAFETY: Before Leaving Or Servicing Machine; Stop On Level Surface, Set Parking Brake.

1. Position a block of wood under the front of the vacuum head.
2. Lower the vacuum head down onto the block of wood, lower the head enough so there is some slack in the lift cable.
3. Go under the machine at the front right side of the machine.
4. Locate the vacuum head lift actuator and the long, black cable nut at the end of the lift cable.
5. Hold the cable from turning with a pliers or a vice grip.
6. Loosen the jam nut against the long, black cable nut.
7. Un-screw the long, black cable nut from the end of the lift cable.
8. Remove the small jam nut and washer from the lift cable.
9. Loosen the two larger jam nuts holding the head lift cable to the actuator mount bracket.
10. Remove the outer most jam nut. Pull the lift cable out of the mount bracket.
11. Remove the hex screw and nut holding the lift cable clamp to the machine frame. Remove the cable clamp.

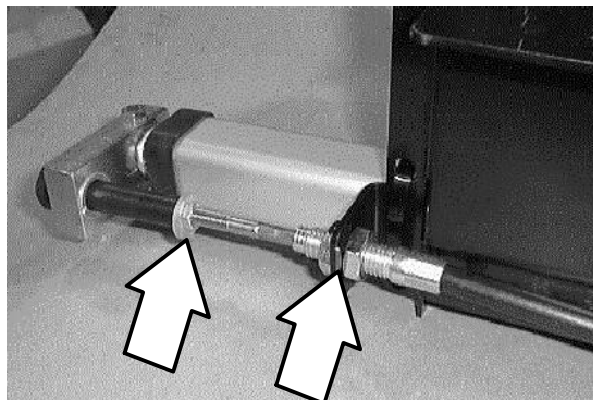
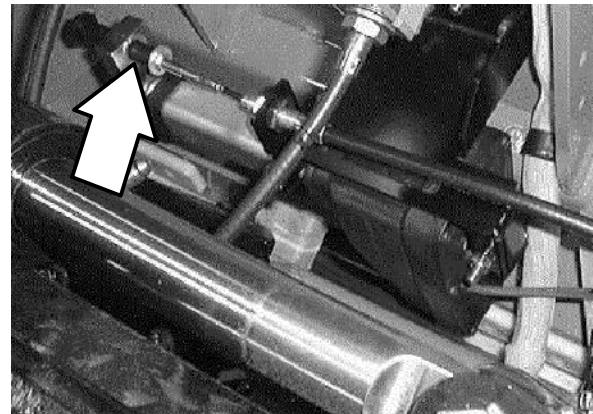
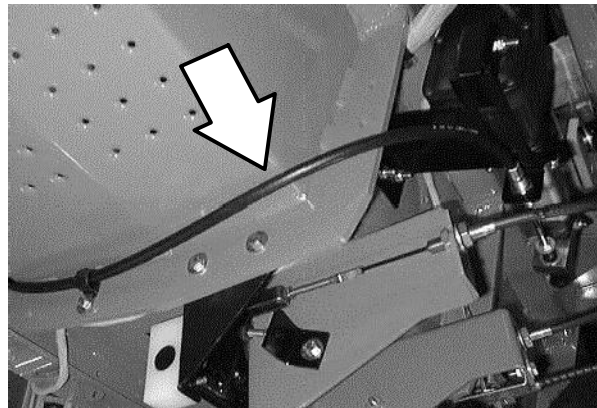

VACUUMING

12. Go to the operators compartment and locate the vacuum head adjustment knob. Remove the adjustment knob.
13. Remove the clevis pin holding the propel pedal to the pivot bracket. Position the propel pedal back out of the way of the vacuum head cable assembly mount plate.
14. Remove the three hex screws holding the slide assembly to the cable assembly mount plate. Remove the slide assembly from the machine.
15. Remove the three hex screws holding the vacuum head cable assembly mount plate to the machine (one on top, two from under front of frame).
16. Pull the vacuum head cable assembly mount plate back away from the machine frame.
17. Remove the cotter pin and clevis pin from the end of the vacuum head lift cable.
18. Loosen the two larger lift cable jam nuts on the cable.
19. Pull the cable out of the mount slot. Remove the lift cable from the machine.

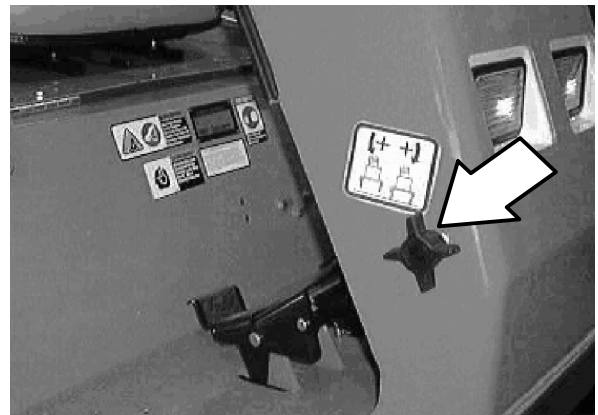
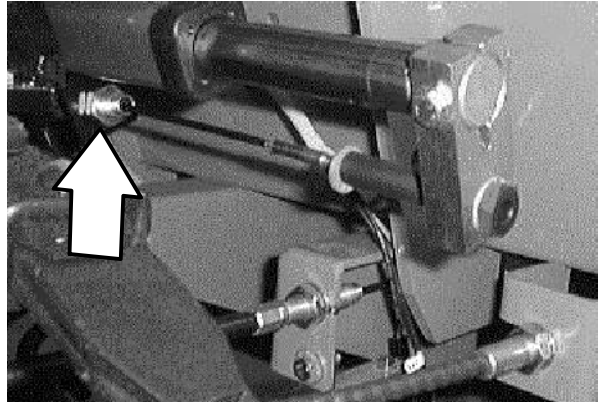

NOTE: Note how the cable was routed in the machine.

20. Position the new cable into the machine. The end of the cable with the clevis goes to the front of the machine. Make sure the new cable is routed the same manner as the old one.
21. Install the upper end of the lift cable into the mount slot on the cable assembly mount plate. Center the jam nuts on the threads and tighten tight. Install the clevis and cotter pin.
22. Position the cable assembly mount plate back against the front of the machine frame. Reinstall the three hex screws and tighten to 18 - 24 Nm (15 - 20 ft. lb).
23. Reinstall the slide assembly and tighten the three hex screws to 18 - 24 Nm (15 - 20 ft. lb).
24. Reinstall the propel pedal, clevis pin, and cotter pin.

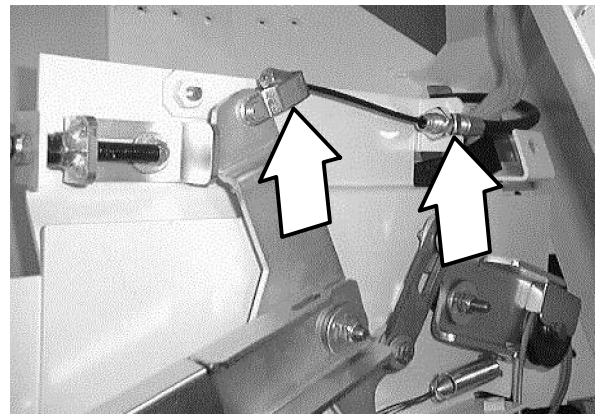
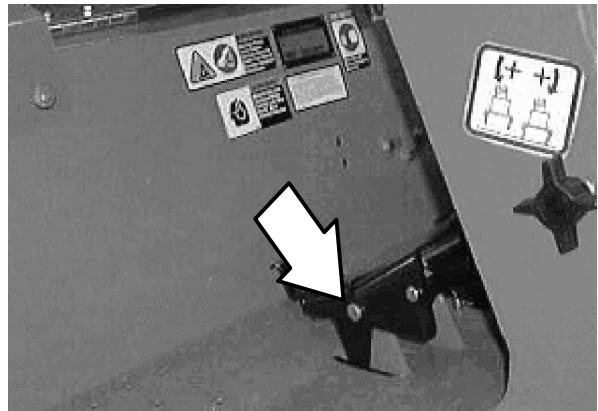

25. Reinstall the vacuum head adjustment knob.
26. Go under the machine and remove one large jam nut from the lower end of the new lift cable.
27. Position the new lift cable through the mount hole in the actuator mount bracket. Reinstall the large jam nut. Leave loose for now.
28. Install one small cable nut and washer on the lower end of the cable.
29. Position the long, black cable lift nut through the hole in the actuator lift block.
30. Thread the long, black lift nut onto the new cable. Leave loose for now.
31. Install the cable clamp on the new cable and into the machine frame. Reinstall the hex screw and nut. Tighten to 18 - 24 Nm (15 - 20 ft. lb).
32. See TO ADJUST VACUUM HEAD ACTUATOR LIFT CABLE instructions in this section.
33. Go back and tighten all jam nuts.
34. Raise the vacuum head and remove the wood block.
35. Operate the machine and check the vacuum head lift actuator for proper operation.

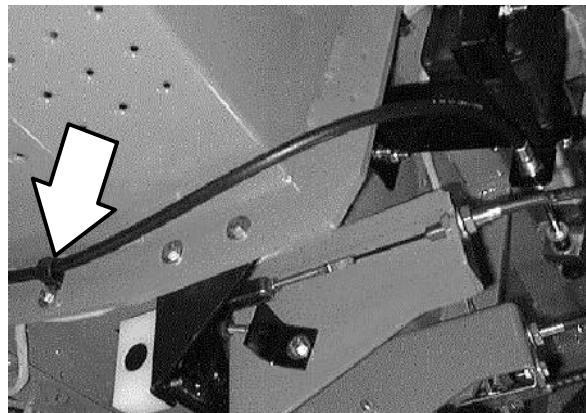
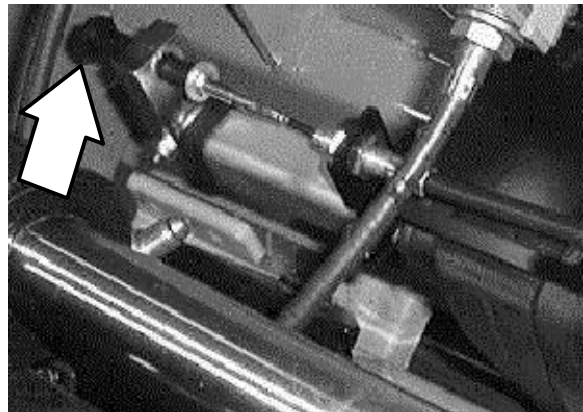
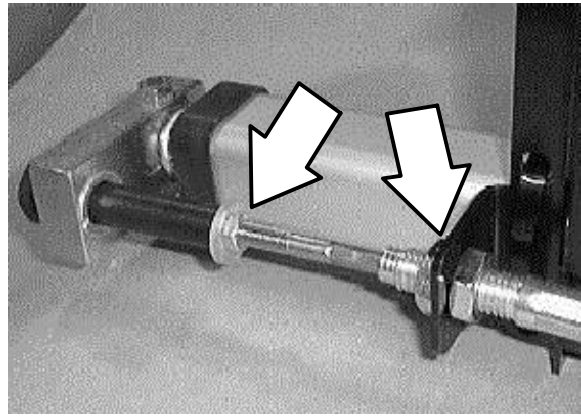

VACUUMING

TO REPLACE VACUUM HEAD SECONDARY LIFT CABLES

FOR SAFETY: Before Leaving Or Servicing Machine; Stop On Level Surface, Set Parking Brake.

1. Position a block of wood under the front of the vacuum head
2. Lower the vacuum head down onto the block of wood, lower the head enough so there is some slack in the main actuator lift cable
3. Locate the two secondary vacuum head lift cables where they attach to the vacuum head.
4. Pull down on the cable that needs to be changed. Remove the cotter pin and clevis pin from the end of the secondary lift cable where it attaches to the vacuum head.
5. Locate the adjustment end of the secondary vacuum head lift cables at the front, bottom of the machine frame. Hold the cable from turning and remove the adjustment nut.
6. Remove the nut and jam nut from the end of the cable attached to the front of the machine frame.
7. Go to the operators compartment and locate the vacuum head adjustment knob. Remove the adjustment knob.
8. Remove the clevis pin holding the propel pedal to the pivot bracket. Position the propel pedal back out of the way of the vacuum head cable assembly mount plate.
9. Remove the three hex screws holding the slide assembly to the cable assembly mount plate. Remove the slide assembly from the machine.
10. Remove the three hex screws holding the vacuum head cable assembly mount plate to the machine (one on top, two from under front of frame).
11. Pull the vacuum head cable assembly mount plate back away from the machine frame.
12. Remove the tension spring holding the two cable pulley pivot brackets together.

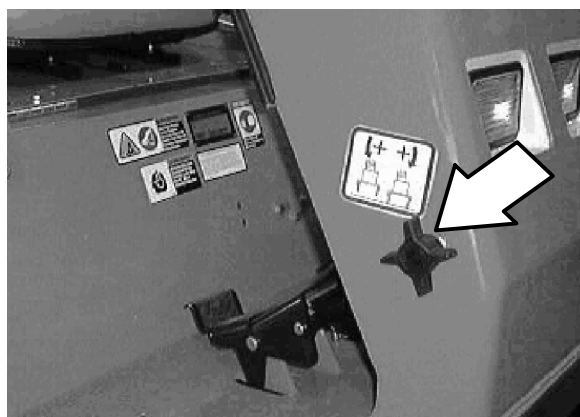
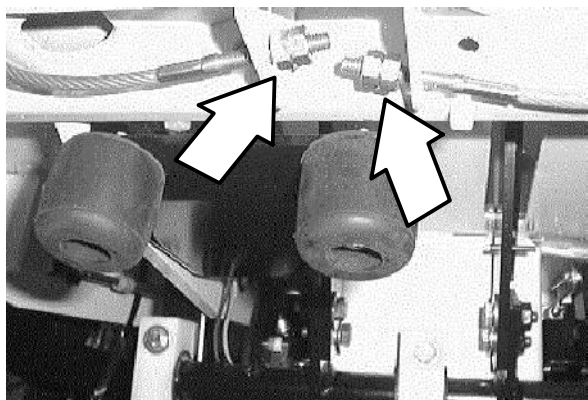
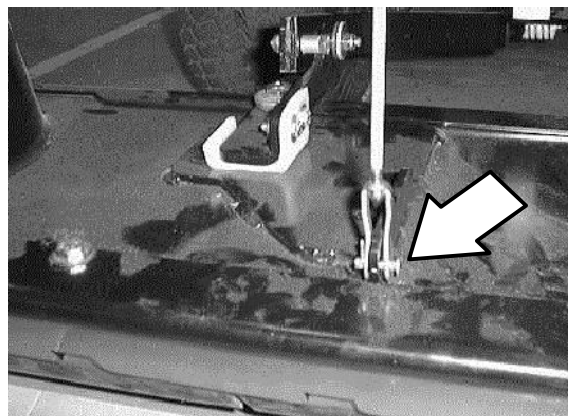
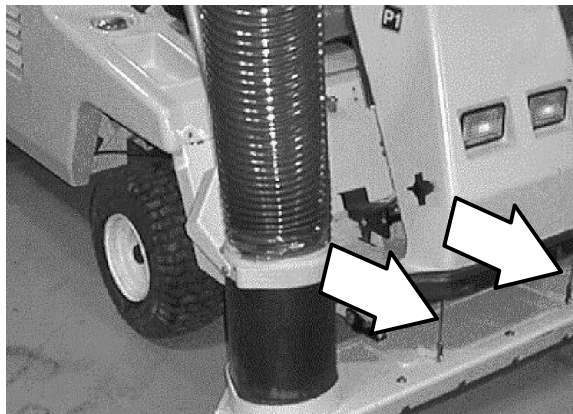

13. Remove the hex screw and nut holding the pulley and pulley cover to the pivot bracket. Pull the pulley cover up far enough to remove the lift cable from the pulley groove. Remove and discard the cable.
14. Position the new cable over the pulley. Push the pulley cover down and tighten the hardware to 18 - 24 Nm (15 - 20 ft. lb). *The threaded end of the cable should be looped toward the center of the pivot brackets.*
15. Position the cable assembly mount plate back against the front of the machine frame. Reinstall the three hex screws and tighten to 18 - 24 Nm (15 - 20 ft. lb).

NOTE: Make sure the new cable is routed through the holes in the front of the frame.

16. Reinstall the slide assembly and tighten the three hex screws to 18 - 24 Nm (15 - 20 ft. lb).
17. Reinstall the propel pedal, clevis pin, and cotter pin.
18. Reinstall the vacuum head adjustment knob.
19. Route the threaded end of the new cable down and around the curved frame bracket and into the adjustment hole. Reinstall the adjustment nut. Leave loose for now.
20. Connect the clevis end of the new cable to the lift bracket on the vacuum head. Reinstall the clevis and cotter pin.
21. Go to the other end of the new cable and hold it from turning. Turn the adjustment nut all the way down to the end of the threads.
22. Raise the vacuum head and remove the wood block.
23. Operate the vacuum head lift. Check for proper operation.

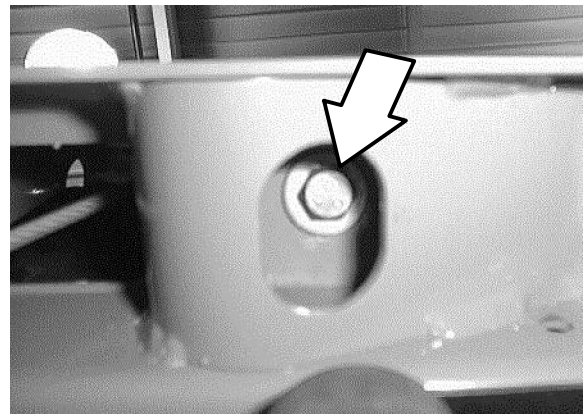
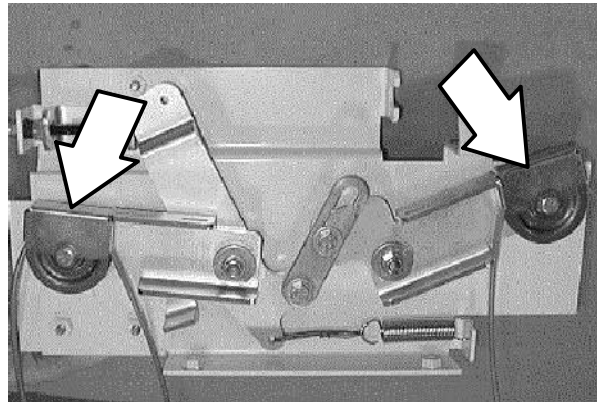
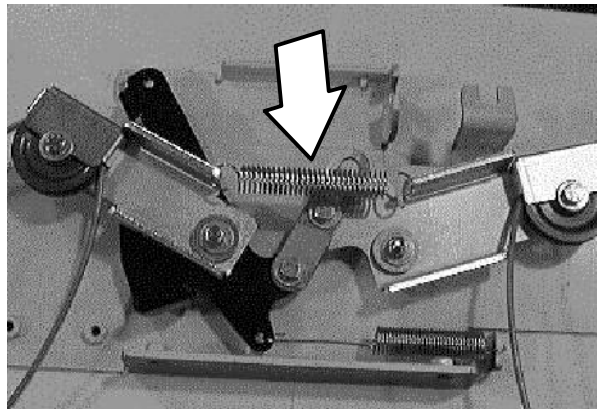
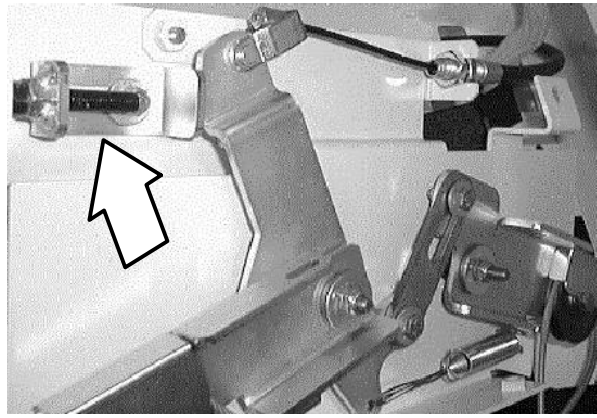

VACUUMING

TO ADJUST VACUUM HEAD ACTUATOR LIFT CABLE

FOR SAFETY: Before Leaving Or Servicing Machine; Stop On Level Surface, Set Parking Brake.

1. Make sure the two shorter vacuum head lift cables have the jam nuts screwed on as far as possible.
2. Extend (raise) the vacuum head lift actuator as far as possible. Go under the front of the machine and check the two black rubber bumpers. The vacuum head should compress the bumpers no more than 1/8 inch. If needed, adjust the vacuum head lift height (see next step).
3. Loosen the jam nut at the end of the long, black lift cable sleeve. Turn the black cable sleeve until the head compresses the rubber bumpers 1/8 inch. Tighten the washer and jam nut against the black cable sleeve. Use blue loctite (242) on the threads of the cable.
4. Go to the head stop adjustment knob and turn all the way clockwise (lowest head position). Lower the actuator until it stops.
5. Go back under the machine and check the black cable sleeve. There should be approximately 1/2 inch of clearance between the head of the black sleeve and the top of the thrust bushing.
6. This procedure will leave the rubber skirts approximately flush with the floor when the head stop is adjusted to the highest position (counter-clockwise).

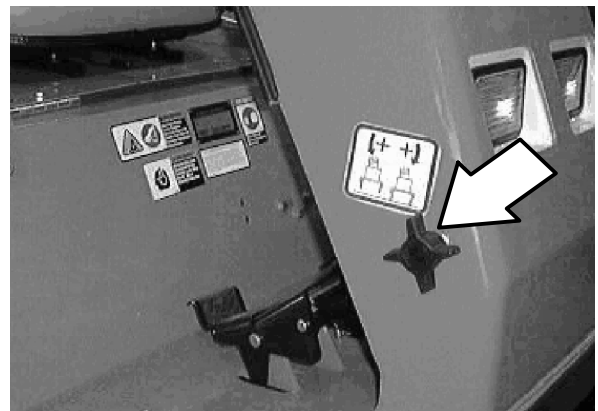
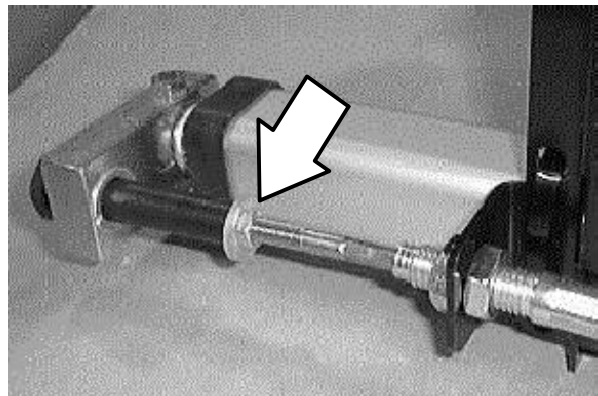
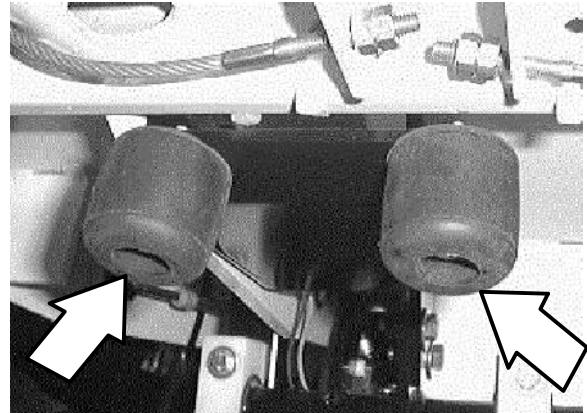
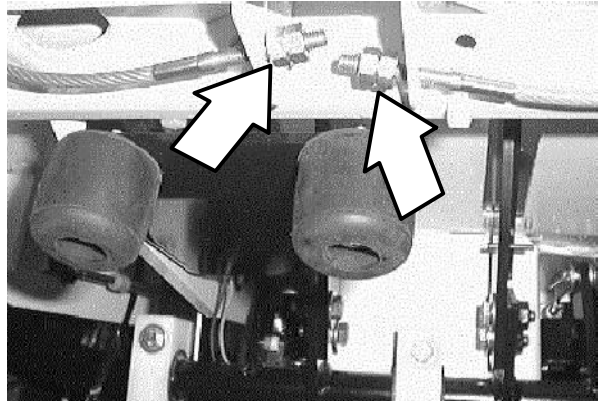

VACUUM FAN

The vacuum fan is mounted to the top of the hopper assembly. A hydraulic motor is used to spin the impeller which creates airflow. This airflow creates vacuum through the vacuum tube and down to the vacuum head. Debris is brought up through the vacuum tube and deposited in the hopper. A screen on the vacuum fan impeller keeps debris from contacting the impeller.

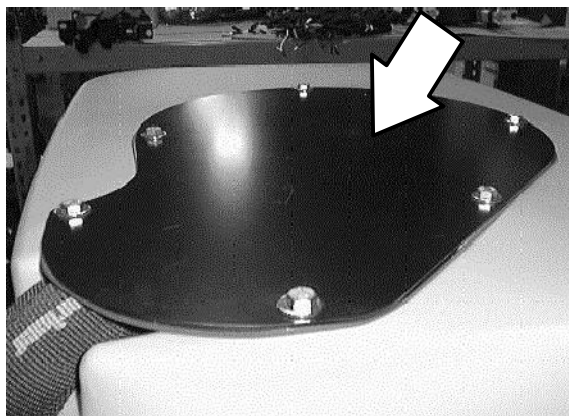

TO REPLACE VACUUM FAN IMPELLER

FOR SAFETY: Before Leaving Or Servicing Machine; Stop On Level Surface, Set Parking Brake.

NOTE: Anytime hopper or vacuum system parts are serviced the seals should be inspected and replaced if necessary.

1. Remove the six screws holding the vacuum fan motor cover plate to the top of the plenum assembly on top of the hopper cover. Remove the plate.

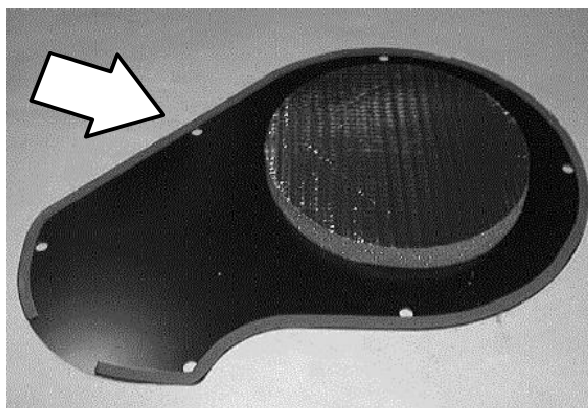

NOTE: Observe hydraulic cleanliness requirements when opening hydraulic lines.

2. Mark, disconnect, and plug the hydraulic lines leading to the vacuum fan motor.
3. Open the hopper cover and tilt the hopper back.
4. Go under the hopper cover and remove the six hex screws holding the cover assembly to the hopper plenum. Remove the cover assembly.
5. Go back under the hopper plenum and locate the vacuum fan impeller screen. Remove the three flat head screws and the one hex screw holding the screen to the impeller.
6. Pull the impeller screen, spacer, and sleeve off the vacuum fan motor shaft.
7. Remove the four hex screws holding the vacuum fan assembly retainer plate to the bottom of the hopper plenum.

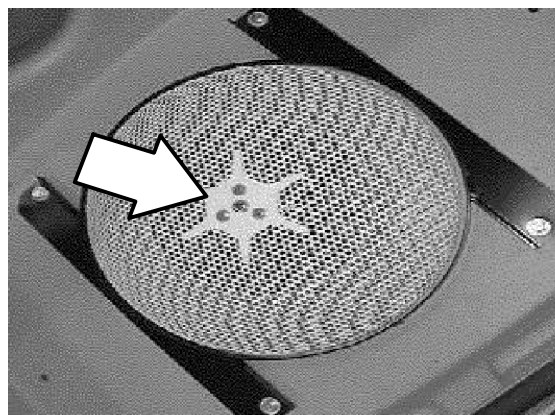
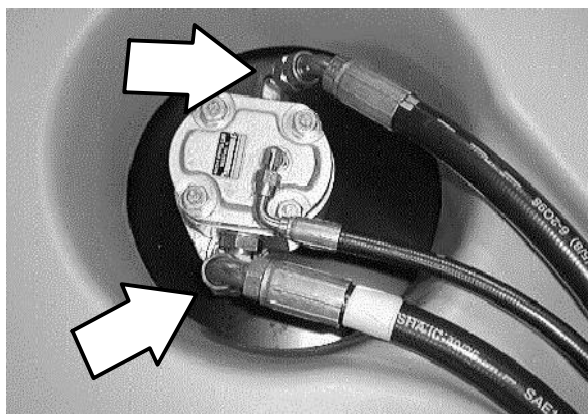

VACUUMING

8. Go to the top of the hopper plenum and remove the vacuum fan assembly from the machine. Set the assembly up side down on a flat surface.
9. Pull the vacuum fan impeller off the fan motor shaft. Retain the key from the motor shaft.
10. Install the new vacuum fan impeller onto the motor shaft.

NOTE: Make sure to use the key that was removed with the old impeller.

11. Turn the assembly over and place it back on top of the hopper plenum. Hold the impeller in place while turning over. Line up the holes in the motor bracket with the holes in the cover.
12. Go under the hopper cover and install the four hex screws into vacuum fan assembly retainer plate. Leave the hardware loose for now.
13. Reinstall the impeller screen, spacer, and sleeve onto the vacuum fan motor shaft.
14. Use blue loctite (242) on the threads of the impeller screen hardware. Reinstall the one M8 hex screw and three M6 flat screws.
15. Tighten the M8 hex screw to 18 - 24 Nm (15 - 20 ft. lb) and the M6 flat screws to 8 - 10 Nm (6 - 8 ft. lb).
16. After the screen has been tighten down, center the string guard (on the retainer plate) around the outside of the screen. Tighten the four screws to 18 - 24 Nm (15 - 20 ft. lb). Use blue loctite (242) on the threads of this hardware.

17. Reinstall cover assembly onto the hopper plenum.

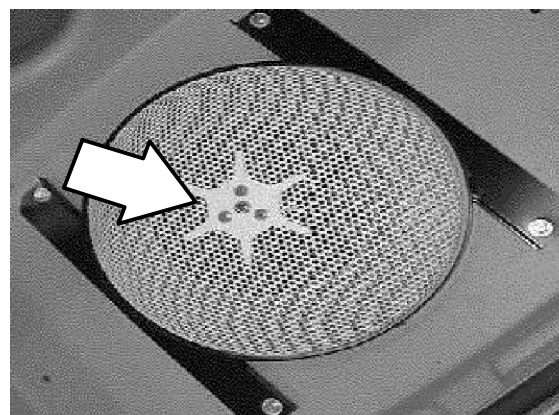
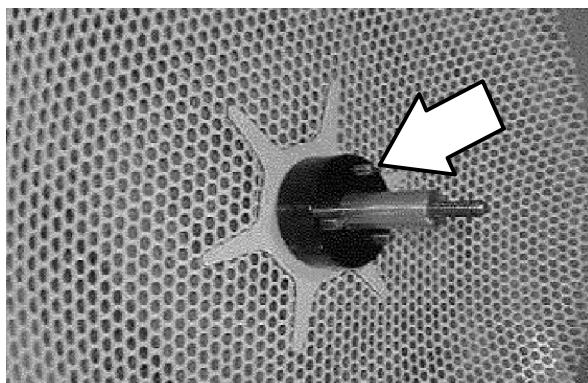
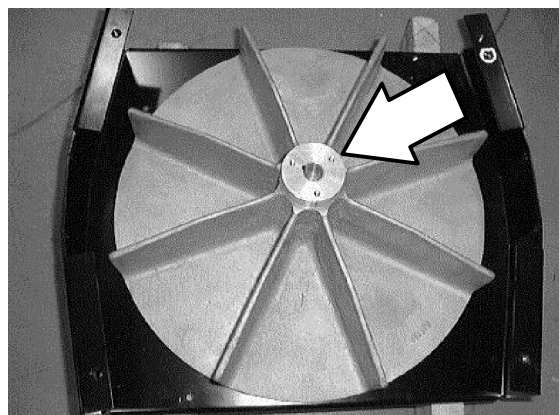
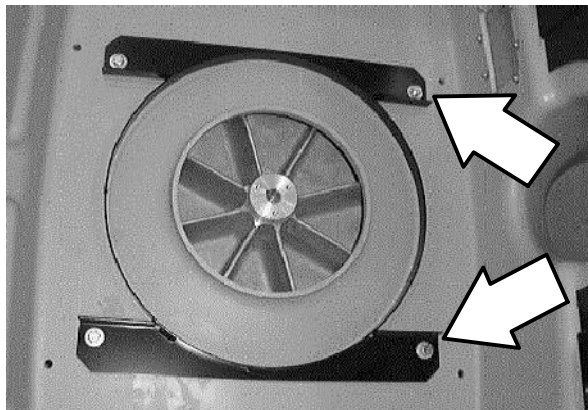

18. Reinstall six hex screws holding the cover assembly to the hopper plenum. Tighten the screws to 18 - 24 Nm (15 - 20 ft. lb).

NOTE: Observe hydraulic cleanliness requirements when opening hydraulic lines.

19. Reconnect the hydraulic lines leading to the vacuum fan motor. See hydraulic schematic in the HYDRAULIC section.
20. Reinstall the six screws holding the vacuum fan motor cover plate to the top of the plenum assembly on top of the hopper cover. Tighten the screws to 18 - 24 Nm (15 - 20 ft. lb).
21. Tilt the hopper forward and close the cover.
22. Operate the machine and check the vacuum fan for proper operation.

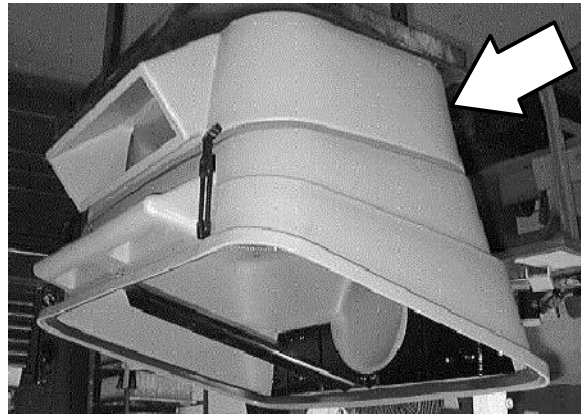
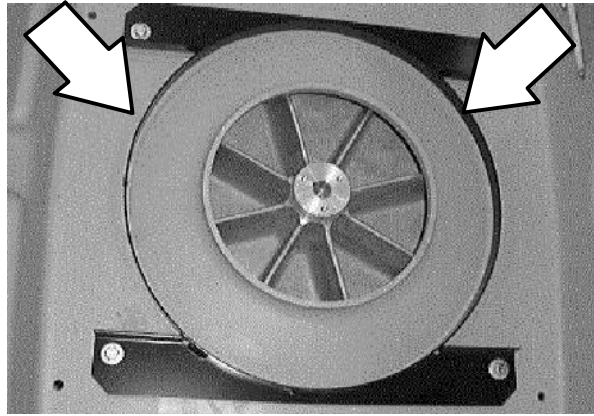

VACUUMING

TO REPLACE VACUUM FAN IMPELLER SCREEN

FOR SAFETY: Before Leaving Or Servicing Machine; Stop On Level Surface, Set Parking Brake.

NOTE: Anytime hopper or vacuum system parts are serviced the seals should be inspected and replaced if necessary.

1. Open the hopper cover.
2. Go under the hopper cover and locate the vacuum fan impeller screen. Remove the three flat head screws and the one hex screw holding the screen to the impeller.
3. Pull the impeller screen off the vacuum fan motor shaft. Make note of the orientation of the spacers.
4. Install the new impeller screen, spacers, and sleeve onto the vacuum fan motor shaft.
5. Use blue loctite (242) on the threads of the impeller screen hardware. Reinstall the one M8 hex screw and three M6 flat screws.
6. Close the hopper cover.
7. Operate the machine and check the vacuum fan for proper operation.

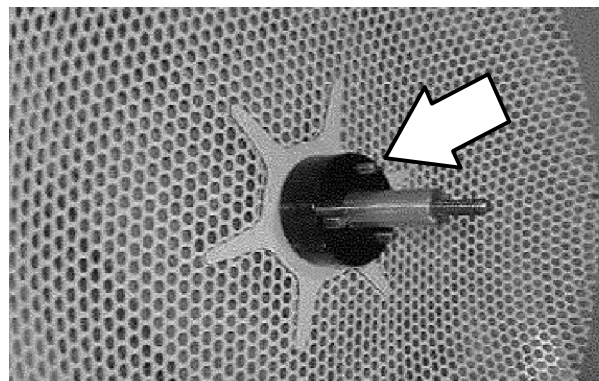
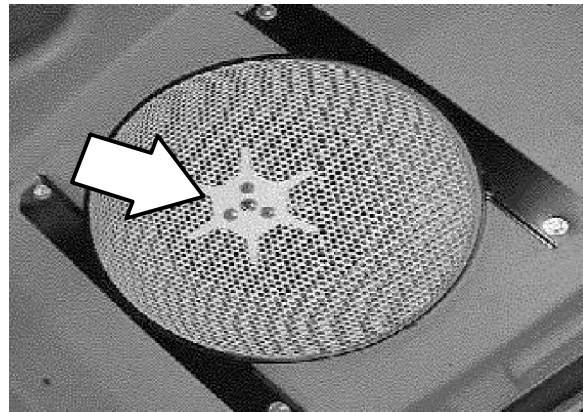
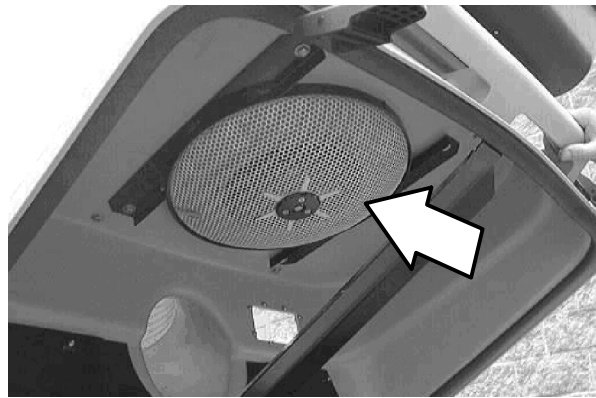

MACHINE TROUBLESHOOTING

Problem	Cause	Remedy
Machine does not start	Glow plug not warmed up properly	Turn key to warm up glow plug
	Fuel filter plugged	Replace fuel filter
	Fuel pump damaged	Replace fuel pump
Machine propels slowly	Cables not adjusted	Readjust stops or cables
Machine does not propel	Machine not on	Start machine
	Parking brake on	Release parking brake
	Towing valve on	Turn towing valve 90°
Poor vacuum performance	Vacuum head or hose clogged	Remove vacuum head or hose blockage
	Hopper vacuum fan clogged	Clean off fan vacuum screen
	Vacuum head not lowered completely	Lower vacuum head completely
	Vacuum head seals damaged	Replace or repair worn vacuum head seals
	Machine propelling too fast	Slow machine speed
	Vacuum not close enough to debris	Move vacuum closer to debris
	Debris hopper full	Empty debris hopper
	Engine throttle too low	Increase engine throttle
	Vacuum bag (option) clogged	Empty Vacuum bag (option)
	Dust filter bag (option) clogged	Empty dust filter bag (option)
	Panel filter (option) clogged	Clean panel filter (option)
No vacuum power	Hopper Thermo Sentry™ on	Check for fire in hopper
	Solenoid valve not operating	Contact TENNANT service personnel
	Vacuum fan not on	Turn vacuum fan on
	Vacuum fan failure	Contact TENNANT service personnel
	Main vacuum hose gate valve closed	Open main vacuum hose gate valve
Vacuum hose unsupported or too low	Gas cylinders damaged	Contact TENNANT service personnel
Excessive Dusting	Vacuum bag (option) open	Close Vacuum bag
	Panel filter (option) door open	Close panel filter door
	Water dust control (option) not on	Turn on water dust control
	Water dust control (option) water tank empty	Fill water dust control tank
	Water dust control (option) spray nozzle clogged	Clean water dust control spray nozzle

CONTENTS

	Page
INTRODUCTION	4-3
ELECTRICAL SYSTEM	4-4
BATTERY	4-4
TO CHARGE BATTERY	4-4
TO REPLACE BATTERY	4-5
INSTRUMENT PANEL	4-6
TO REMOVE INSTRUMENT PANEL ..	4-6
TO INSTALL INSTRUMENT PANEL ..	4-7
FUSES	4-8
CIRCUIT BREAKERS	4-8
TO REPLACE CIRCUIT BREAKER ...	4-9
TO REPLACE RELAY	4-11
ACTUATOR	4-12
TO REPLACE VACUUM HEAD	
LIFT ACTUATOR	4-12
TO REPLACE ENGINE ALTERNATOR .	4-14
TO REPLACE ENGINE STARTER	4-16
ELECTRICAL SCHEMATIC	4-17
WIRE HARNESS	4-19
TROUBLESHOOTING	4-25

INTRODUCTION

The machines electrical system consists of the batteries, instrument panel, actuators, switches, relays, and circuit breakers.

ELECTRICAL SYSTEM

The electrical system on the model ATLV 4300 is a 12 volt system consisting of a battery, alternator, circuit breakers, relays, and switches.

BATTERY

The battery is located under the operator's seat and can be accessed by lifting the seat up.

After the first 50 hours of operation, and every 200 hours after that, clean and tighten the battery connections.

Check the electrolyte level every 200 hours of operation. Only add distilled water.

FOR SAFETY: When Servicing Machine, Avoid Contact With Battery Acid.

TO CHARGE BATTERY

FOR SAFETY: Before Leaving Or Servicing Machine; Stop On Level Surface, Set Parking Brake, turn off machine, and remove key.

1. Open the seat support and engage the prop rod.
2. Locate the battery at the center of the machine, on top and ahead of the front axle.
3. Remove the battery negative cable.
4. Connect the battery charger to the battery. Make sure to hook the red clamp on the positive post and the black clamp to the negative post.
5. Start the charger. Check the voltage meter on the charger for proper charge voltage.
6. Remove the charger after the voltage meter reads a full charge.
7. Reinstall the negative battery cable and start the machine. Check the battery for proper operation.
8. Disengage the prop rod and lower the seat support.

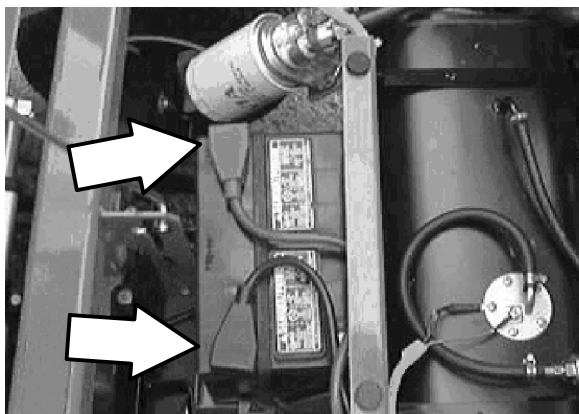
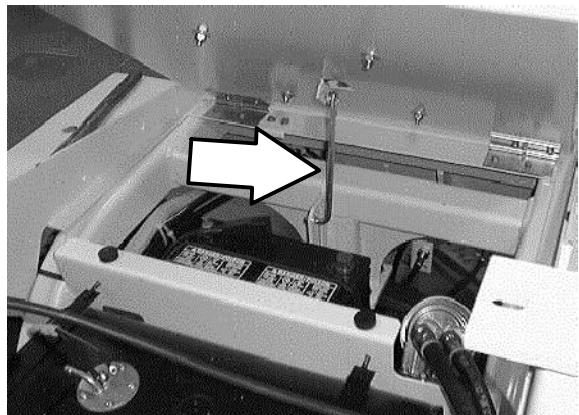
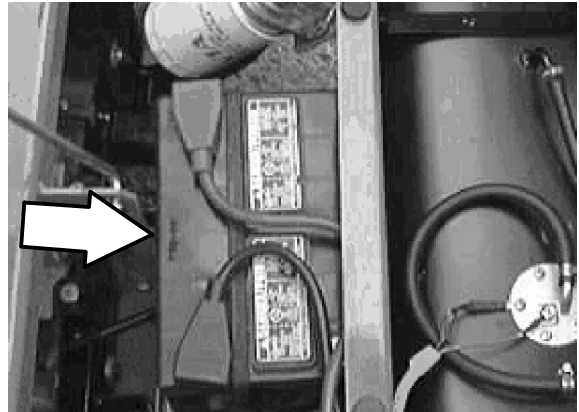

TO REPLACE BATTERY

FOR SAFETY: Before Leaving Or Servicing Machine; Stop On Level Surface, Set Parking Brake, turn off machine, and remove key.

1. Open the seat support and engage the prop rod.
2. Locate the battery at the center of the machine, on top and ahead of the front axle.
3. Unhook and remove the rubber battery hold down strap or remove the threaded hold down bracket.
4. Remove the battery negative and positive cables.
5. Lift the battery out of the machine.
6. Install the new battery in the machine in the same orientation as the old one.
7. Reconnect the battery cables to the battery (*red cable to positive post, black cable to negative post*)
8. Reinstall the rubber battery hold down strap or reinstall the threaded hold down bracket.
9. Disengage the prop rod and lower the seat support.
10. Check the new battery for proper operation. If battery needs charging, see TO CHARGE BATTERY instructions in this section.

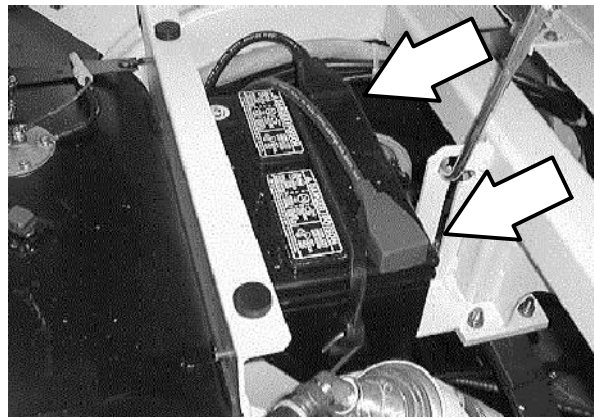
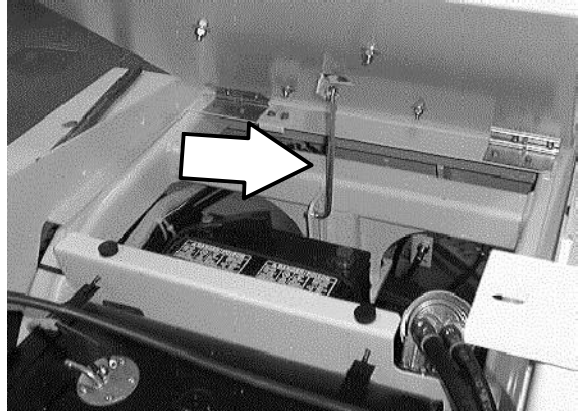

INSTRUMENT PANEL

The instrument panel on the model ATLV™ 4300 is used to hold most of the electrical switches, indicator lights, circuit breakers, and meters.

TO REMOVE INSTRUMENT PANEL

FOR SAFETY: Before Leaving Or Servicing Machine; Stop On Level Surface, Set Parking Brake, turn off machine, and remove key.

1. Open the seat support and engage the prop rod.
2. Locate the battery at the center of the machine, on top and ahead of the front axle.
3. Remove the battery negative cable.
4. Disengage the prop rod and lower the seat support.
5. Remove the cap from the center of the steering wheel (snap out).
6. Remove the M20 hex nut from the center of the steering wheel.
7. Use a puller to remove the steering wheel from the steering column.
8. Remove the knob from the tilt steering wheel pull lever.
9. If the machine is equipped with turn signals, remove the turn signal unit from the steering column.
10. Remove the two smaller pan screws from the top side of the instrument panel.
11. Remove the two larger pan screws from the back side of the instrument panel.
12. Carefully pull the instrument panel up until the rubber boot clears the steering column.
13. Place the instrument panel back, against the kick panel of the operators compartment.
14. The components located on the instrument panel can now be serviced.

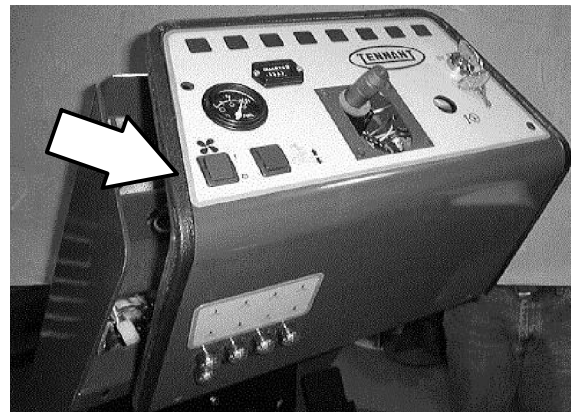
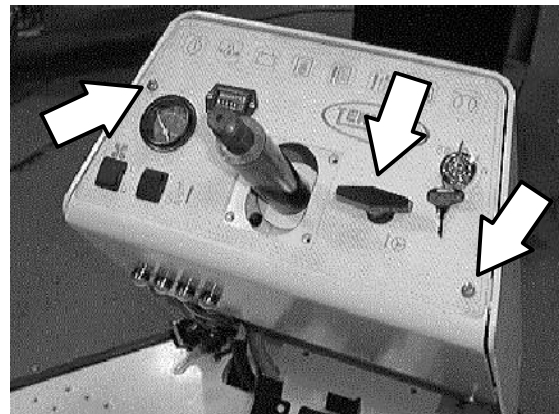
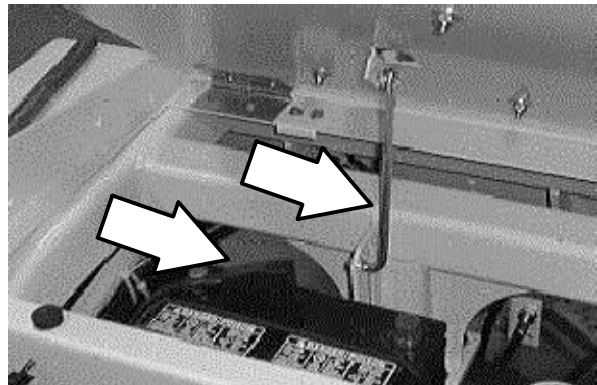
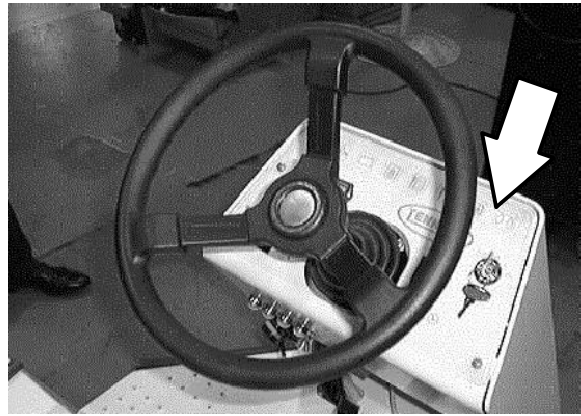

TO INSTALL INSTRUMENT PANEL

FOR SAFETY: Before Leaving Or Servicing Machine; Stop On Level Surface, Set Parking Brake, turn off machine, and remove key.

1. Position the instrument panel and rubber boot over the top of the steering column. *Be careful not to tear the boot.*
2. Push the panel down until the four mount holes line up with the weldnuts.
3. Reinstall the two small pan screws on top of the panel and the two larger pan screws on the back side of the panel. Hand tighten.
4. Reinstall the tilt steering rod knob. Spin down tight.
5. Reinstall the steering wheel and M20 nut. Tighten tight.
6. Reinstall the cap in the center of the steering wheel (snap in).
7. Reinstall the turn signal assembly if the machine is equipped with road light option.
8. Open the seat support and engage the prop rod.
9. Reconnect the battery cable to the battery (*red cable to positive post, black cable to negative post*).
10. Disengage the prop rod and lower the seat support.
11. Start the machine and check for proper operation.

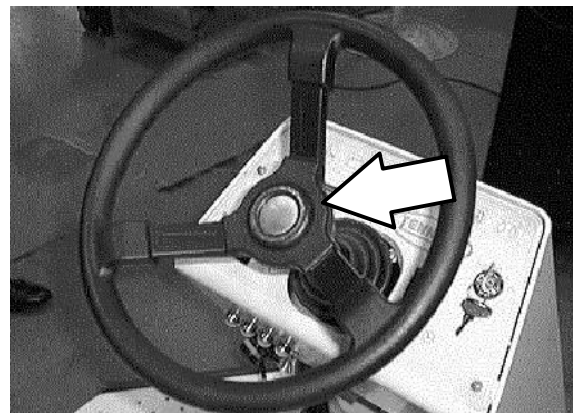
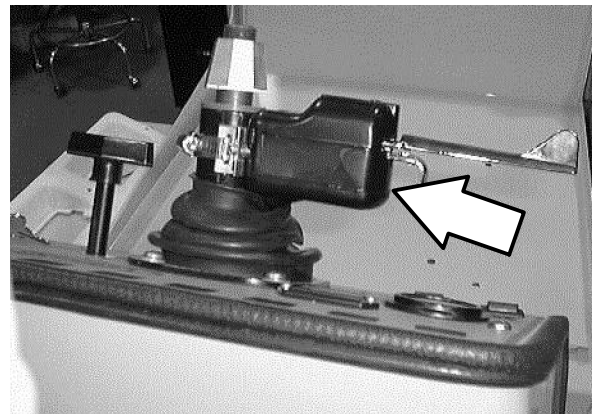
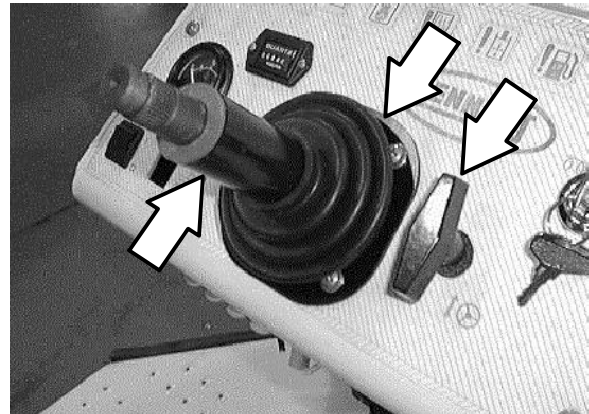
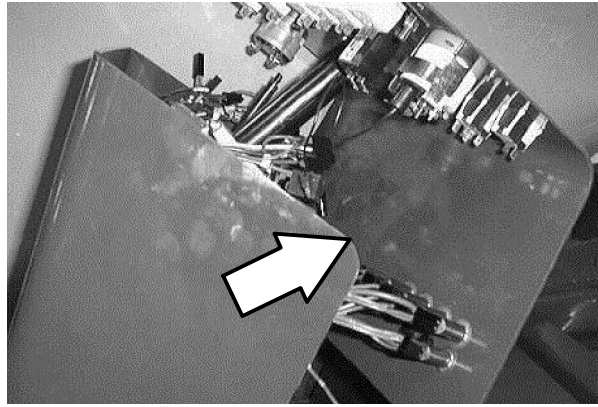

ELECTRICAL

FUSE

The *fuse* is a one-time protection device designed to stop the flow of current in the event of a circuit overload.

NOTE: Never substitute higher value fuses than specified.

The fuse is an in-line type and is located in the main harness, behind the circuit breaker panel.

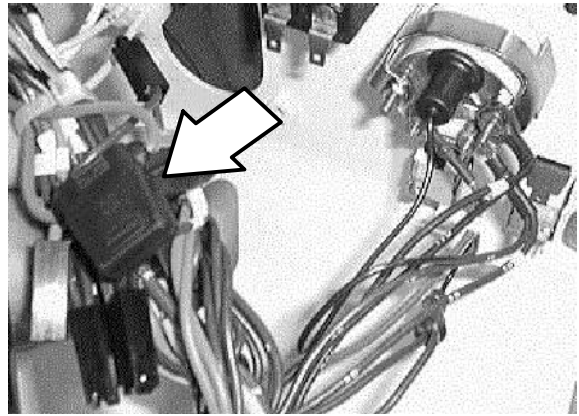

Fuse	Rating	Circuit Protected
FU-1	30 A	Glow plug

CIRCUIT BREAKERS

The *circuit breakers* are resettable electrical circuit protection devices. Their design stops the flow of current in the event of a circuit overload. Once a circuit breaker is tripped, it must be reset manually. Press the reset button after the breaker has cooled down.

If the overload that caused the circuit breaker to trip is still there, the circuit breaker will continue to stop current flow until the problem is corrected.

The circuit breaker panel is located above the foot pedals

The chart lists the circuit breakers and the electrical components they protect.



Breaker	Rating	Circuit Protected
CB-1	15 A	Accessory/ Vac/ Hyd
CB-2	15 A	Horn
CB-3	15 A	Work Lights (Opt)
CB-4	15 A	Operating Lights
CB-5	15 A	Brake/ Turn signals (Opt)
CB-6	15 A	Options
CB-7	15 A	Options
CB-8	15 A	Options

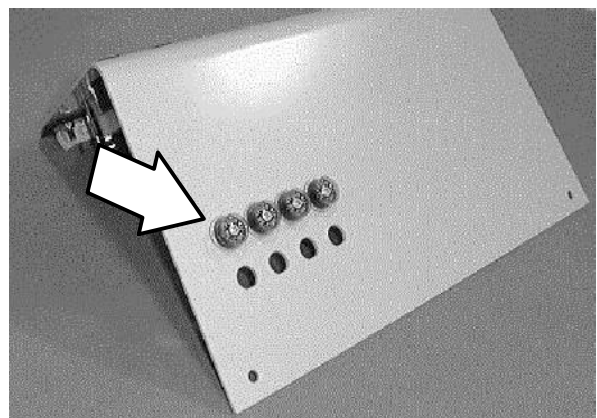

TO REPLACE CIRCUIT BREAKER

FOR SAFETY: Before Leaving Or Servicing Machine; Stop On Level Surface, Set Parking Brake, turn off machine, and remove key.

1. Open the seat support and engage the prop rod.
2. Locate the battery at the center of the machine, on top and ahead of the front axle.
3. Remove the battery negative cable.
4. Disengage the prop rod and lower the seat support.
5. Remove the instrument panel. See TO REMOVE INSTRUMENT PANEL instructions in this section.
6. Locate the circuit breaker that needs to be changed.
7. Mark and disconnect the wires leading to the back of the circuit breaker.
8. Remove the metal retainer ring from the back of the circuit breaker.
9. Push the circuit breaker out of the hole. Retain the clear, rubber boot and discard the circuit breaker.
10. Position the new circuit breaker into the mount hole.

NOTE: The mount hole has a "D" shape to match the shape of the circuit breaker.

11. Install the metal retainer ring onto the back of the new circuit breaker. Push the retainer all the way down the circuit breaker.

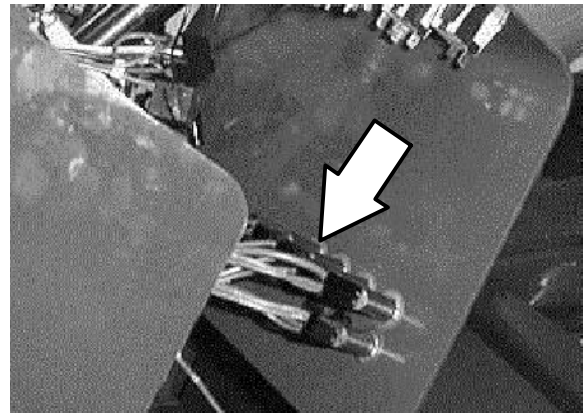
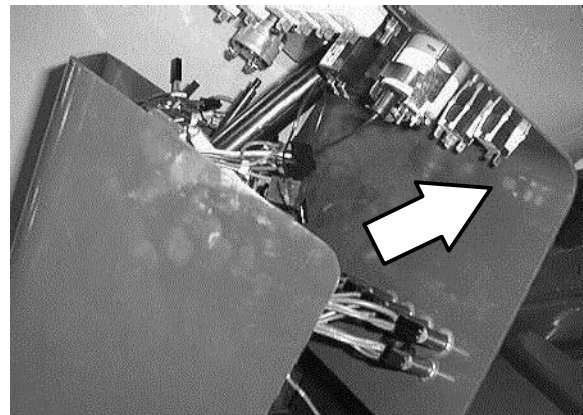
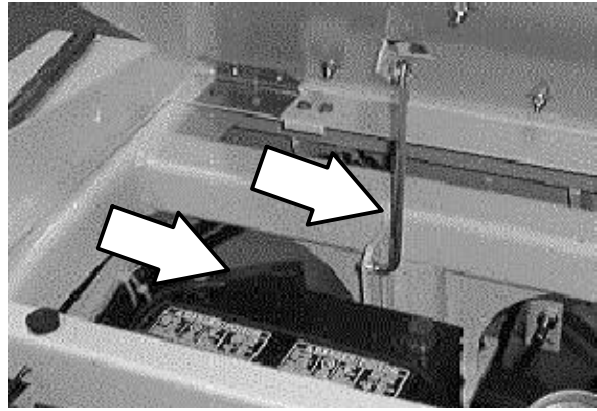

ELECTRICAL

12. Install the rubber boot onto the out side of the new circuit breaker.
13. Reconnect the electrical wires to the new circuit breaker. See schematic in the ELECTRICAL section.
14. Reinstall the instrument panel. See TO INSTALL INSTRUMENT PANEL instructions in this section.
15. Open the seat support and engage the prop rod.
16. Reconnect the battery cable to the battery (*red cable to positive post, black cable to negative post*)
17. Disengage the prop rod and lower the seat support.
18. Start the machine and check for proper operation.

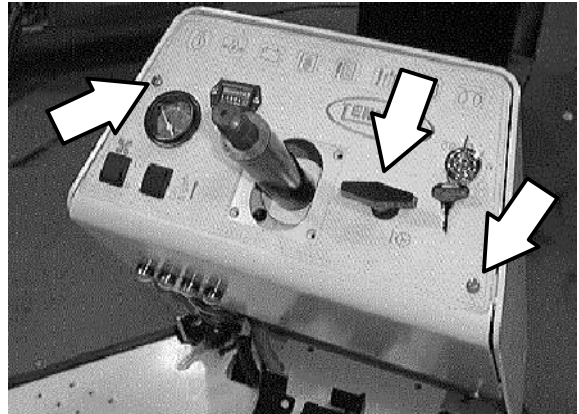
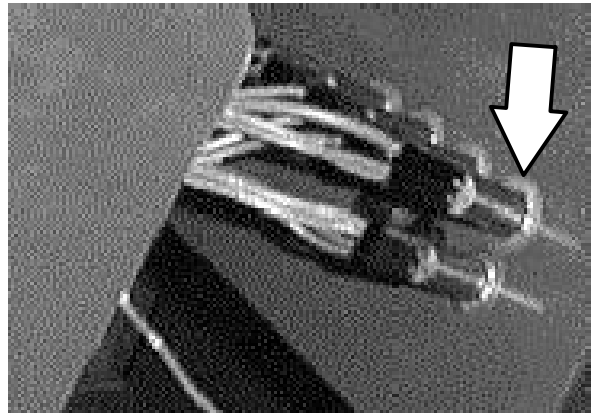

TO REPLACE RELAY

FOR SAFETY: Before Leaving Or Servicing Machine; Stop On Level Surface, Set Parking Brake, turn off machine, and remove key.

1. Open the seat support and engage the prop rod.
2. Locate the battery at the center of the machine, on top and ahead of the front axle.
3. Remove the battery negative cable.
4. Disengage the prop rod and lower the seat support.
5. Remove the instrument panel. See TO REMOVE INSTRUMENT PANEL instructions in this section.
6. Locate the relay that needs to be changed.
7. Disconnect the wire connector leading to the back of the relay.
8. Remove the hex screw and nut holding the relay to the machine frame. Remove and discard the relay.
9. Position the new relay in the machine and reinstall the hex screw and nut. Hand tighten.
10. Reconnect the electrical connector to the new relay. See schematic in the ELECTRICAL section.
11. Reinstall the instrument panel. See TO INSTALL INSTRUMENT PANEL instructions in this section.
12. Open the seat support and engage the prop rod.
13. Reconnect the battery cable to the battery (*red cable to positive post, black cable to negative post*)
14. Disengage the prop rod and lower the seat support.
15. Start the machine and check for proper operation.

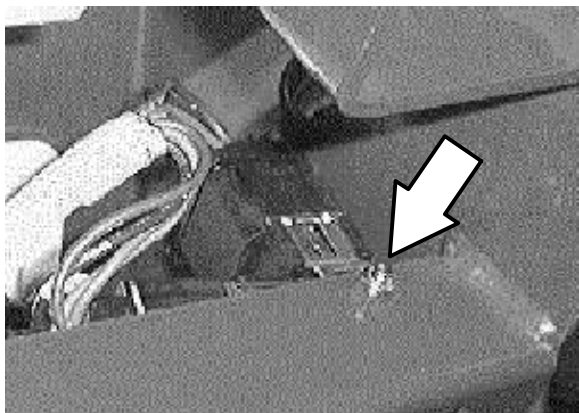
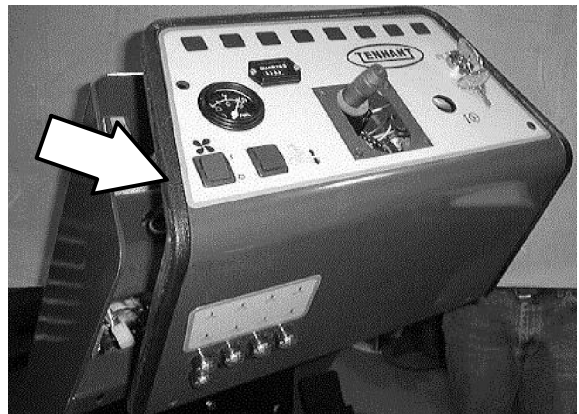
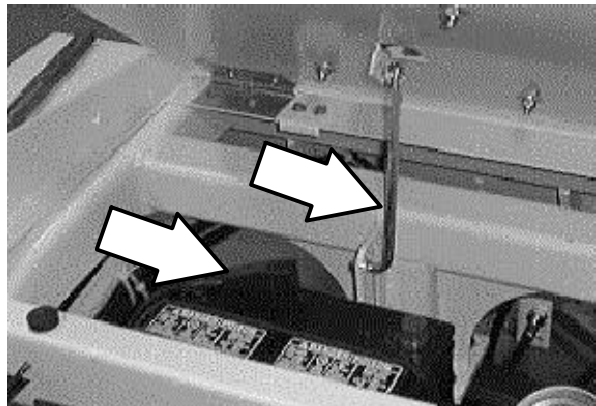
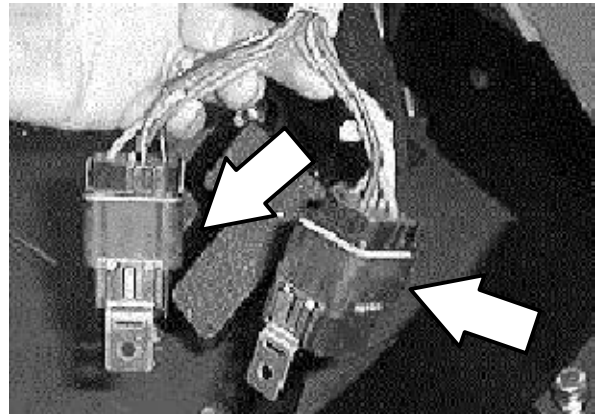

ACTUATOR

The actuator on the model ATLV™ 4300 is used to raise and lower the vacuum head on the front of the machine. The actuator is connected to a lift cable that pulls on a pulley assembly to raise the vacuum head.

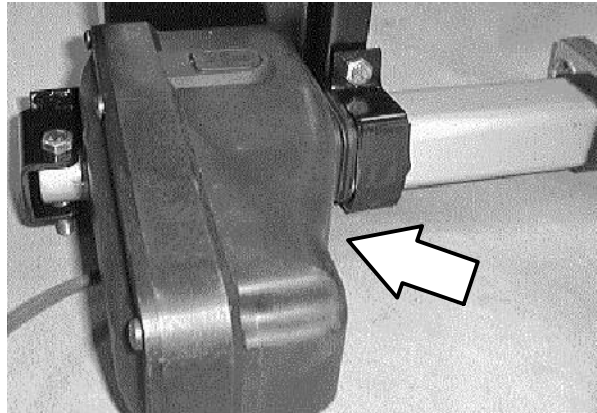

TO REPLACE VACUUM HEAD LIFT ACTUATOR

FOR SAFETY: Before Leaving Or Servicing Machine; Stop On Level Surface, Set Parking Brake, turn off machine, and remove key.

1. Position a block of wood under the front of the vacuum head.
2. Lower the vacuum head down onto the block of wood, lower the head enough so there is some slack in the lift cable.
3. Go under the machine at the front right side of the machine.
4. Locate the vacuum head lift actuator and the long, black cable nut at the end of the lift cable.
5. Hold the cable from turning with a pliers or a vice grip.
6. Loosen the jam nut against the long, black cable nut.
7. Un-screw the long, black cable nut from the end of the lift cable.
8. Disconnect the actuator from the main electrical harness.

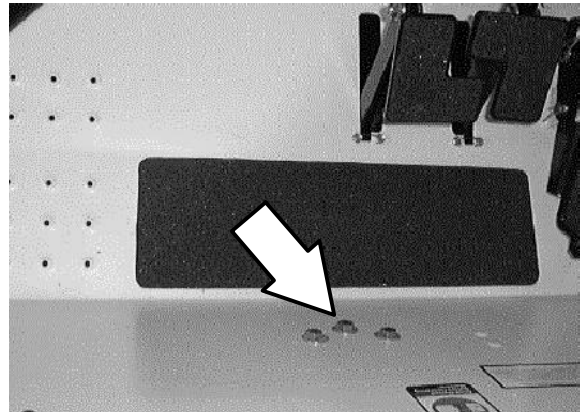
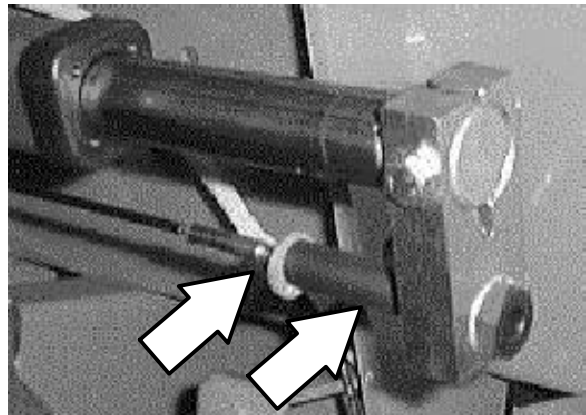

9. Go to the operators compartment and remove the three actuator mount screws from the back kick panel.
10. Drop the vacuum head lift actuator assembly out of the machine.
11. Remove the three hex screws and two mount brackets holding the actuator to the main mount bracket. Remove the actuator.

NOTE: Make sure to retain the gasket.

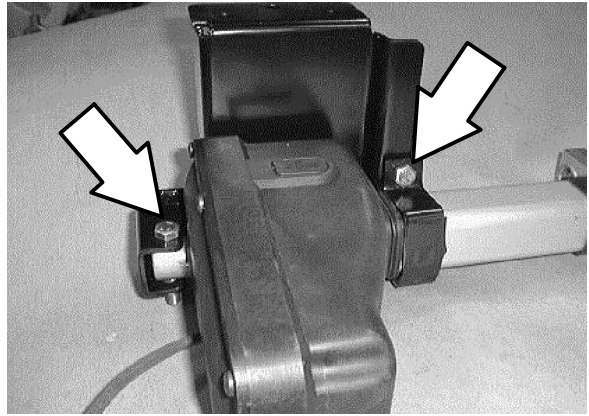

12. Remove the long M8 hex screw holding the cable block to the shaft of the actuator. Remove the cable block and position it onto the new actuator in the same orientation.
13. Reinstall the long M8 hex screw. Tighten to 18 - 24 Nm (15 - 20 ft. lb).
14. Position the new actuator onto the main mount bracket. Reinstall the two brackets and three hex screws. Tighten to 18 - 24 Nm (15 - 20 ft. lb).

NOTE: Make sure to reinstall the gasket to protect the aluminum housing on the actuator.

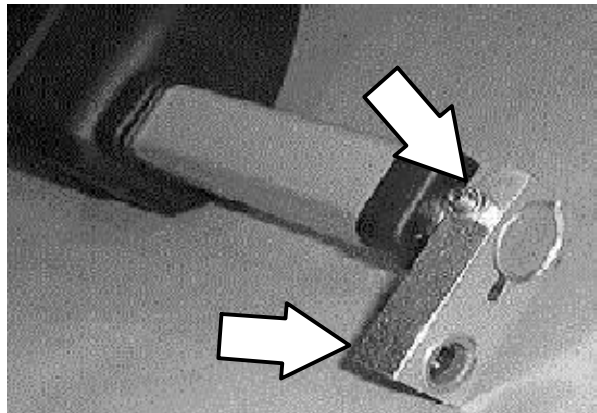

15. Position the actuator assembly back into the machine. Reinstall the three hex screws. Tighten to 18 - 24 Nm (15 - 20 ft. lb).
16. Reconnect the actuator to the main electrical harness.
17. Position the long, black cable lift sleeve through the hole in the actuator lift block.
18. Thread the long, black lift sleeve onto the end of the vacuum head lift cable. Leave loose for now.

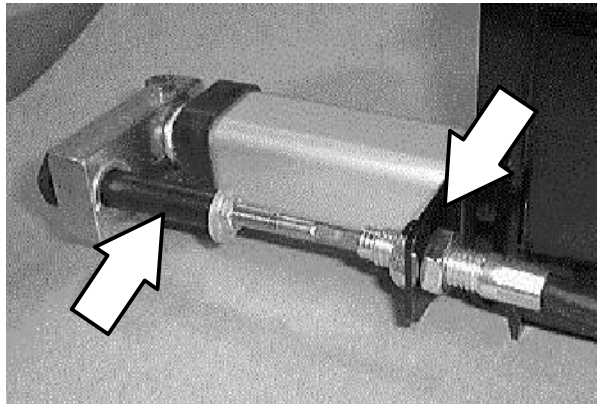

19. See TO ADJUST vacuum HEAD ACTUATOR LIFT CABLE instructions in the vacuum section.
20. Operate the machine and check the vacuum head lift actuator for proper operation.

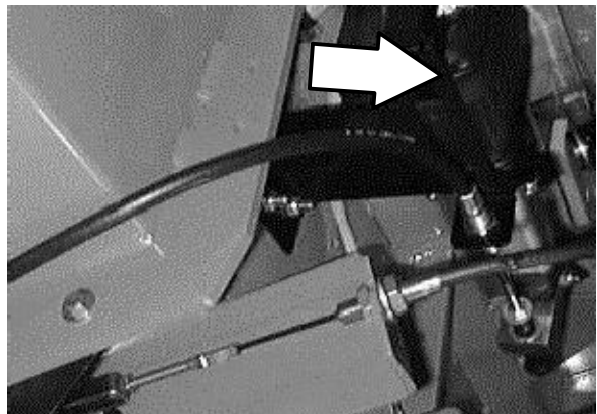

TO REPLACE ENGINE ALTERNATOR

FOR SAFETY: Before Leaving Or Servicing Machine; Stop On Level Surface, Set Parking Brake, Turn Off Machine And Remove Key.

1. Tilt the seat assembly forward and engage the prop rod. Disconnect the battery cables from the battery.
2. Open the top engine cover.
3. Locate the alternator at the front right area of the engine.
4. Disconnect the wires from the back of the alternator.
5. Loosen the hex screw holding the top of the alternator to the pivot bracket.
6. Loosen the hex screw on the bottom of the alternator.
7. Pivot the alternator in toward the engine and remove the fan belt from the sheave.
8. Remove both hex screws. Remove the old alternator out past the exhaust pipe.
9. Position the new alternator in place. Go in front the exhaust pipe.
10. Reinstall the longer lower hex bolt and nut. Leave loose for now.
11. Reinstall the shorter hex bolt in the top of the alternator. Leave loose for now.
12. Reinstall the fan/alternator belt.

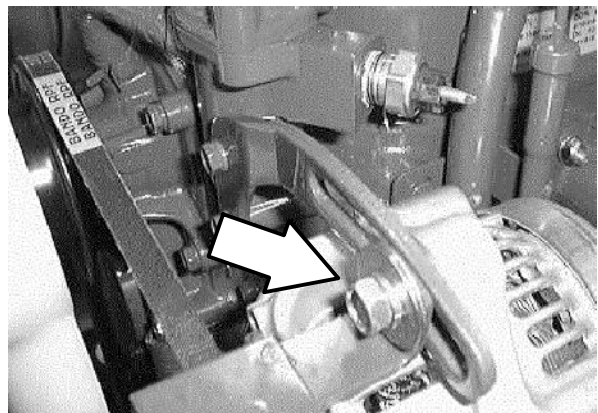
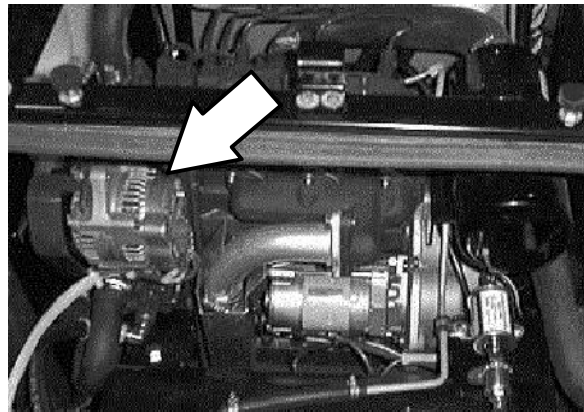
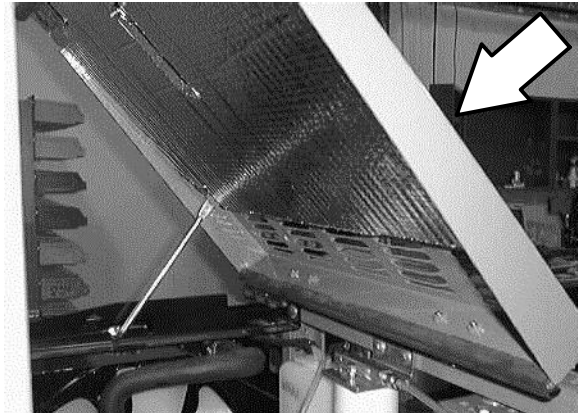
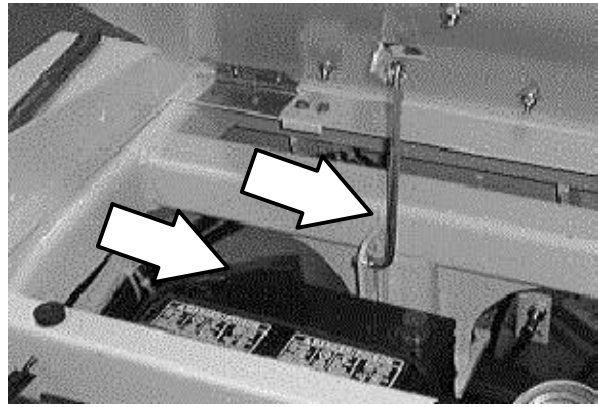

- Using a pry bar, pull the alternator away from the engine until the belts are tight. Proper belt tension is 10 mm (0.40 in) from a force of 4 to 5 kg (8 to 10 lb) applied at the mid-point of the longest span. Check and adjust the belt tension every 100 hours of operation. Hand tighten the top hex bolt tight.

 **WARNING: Moving Belt And Fan Blades. Keep Away.**

- Firmly tighten the lower hex bolt.
- Reconnect the electrical wires to the back of the alternator. See schematic in this section.
- Reconnect the battery cables to the battery.
- Close the engine cover and lower the seat assembly.
- Start the engine and check the alternator for proper operation.

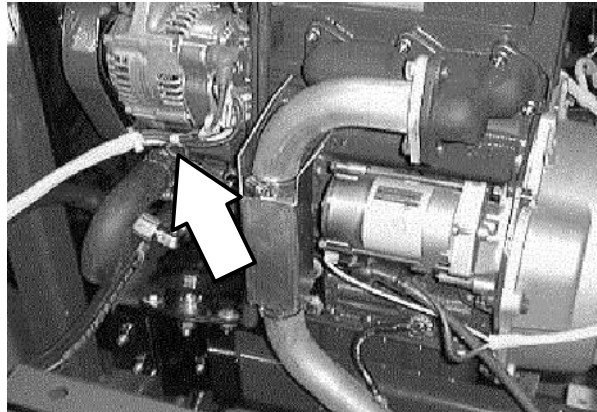
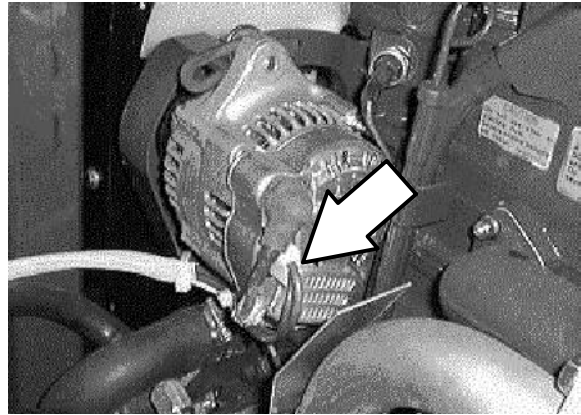
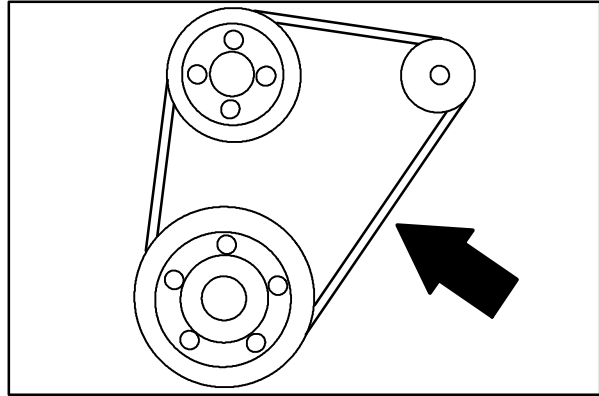

TO REPLACE ENGINE STARTER

FOR SAFETY: Before Leaving Or Servicing Machine; Stop On Level Surface, Set Parking Brake, Turn Off Machine And Remove Key.

1. Tilt the seat assembly forward and engage the prop rod. Disconnect the battery cables from the battery.
2. Open the top engine cover.
3. Disconnect the wires from the starter motor.
4. Remove the two hex screws holding the exhaust pipe to the exhaust manifold. Pull the pipe out of the way for clearance to remove the starter.
5. Remove the two hex nuts holding the starter to the engine. Remove the starter from the flywheel housing and out of the machine.
6. Position the new starter back in the flywheel housing. Re-use the two hex nuts and tighten to 18 - 24 Nm (15 - 20 ft lb).
7. Reconnect the electrical wires to the starter. See schematic in this section.
8. Reinstall the exhaust pipe to the exhaust manifold. Reinstall the two hex screws and tighten to 18 - 24 Nm (15 - 20 ft lb).
9. Reconnect the battery cables to the battery and check the starter for proper operation.
10. Close the engine cover and pivot the seat assembly down.

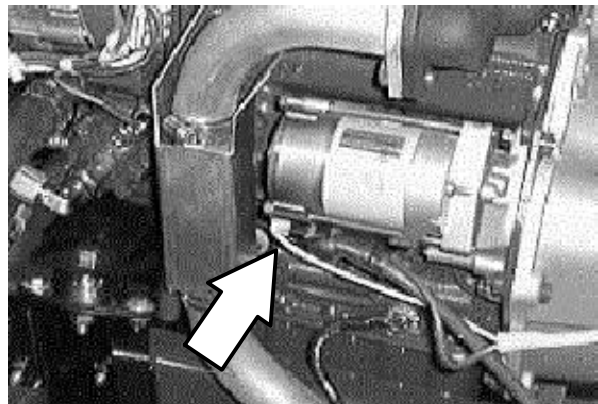
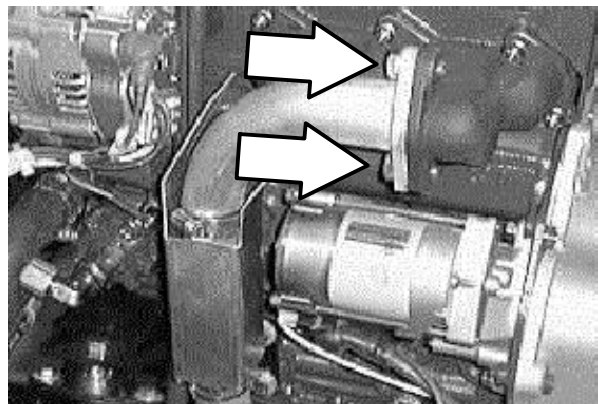
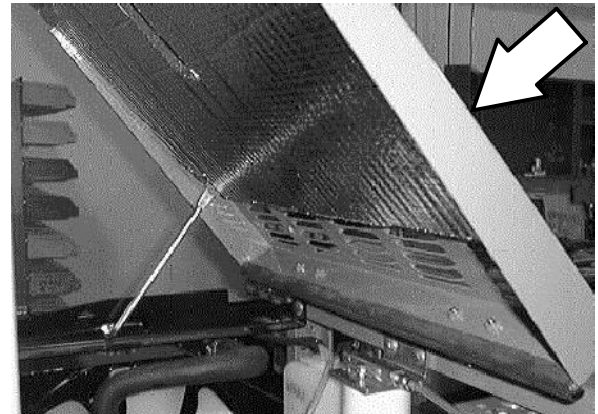
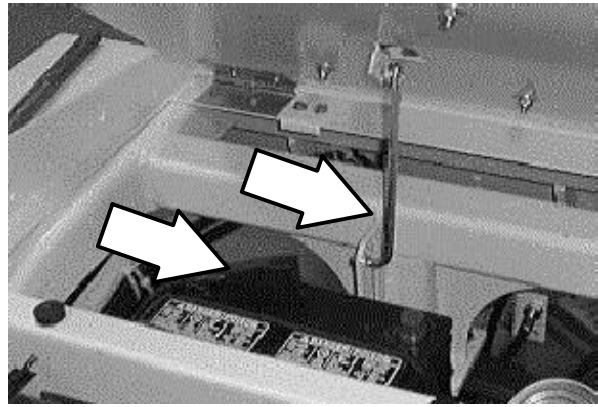

ELECTRICAL SCHEMATIC

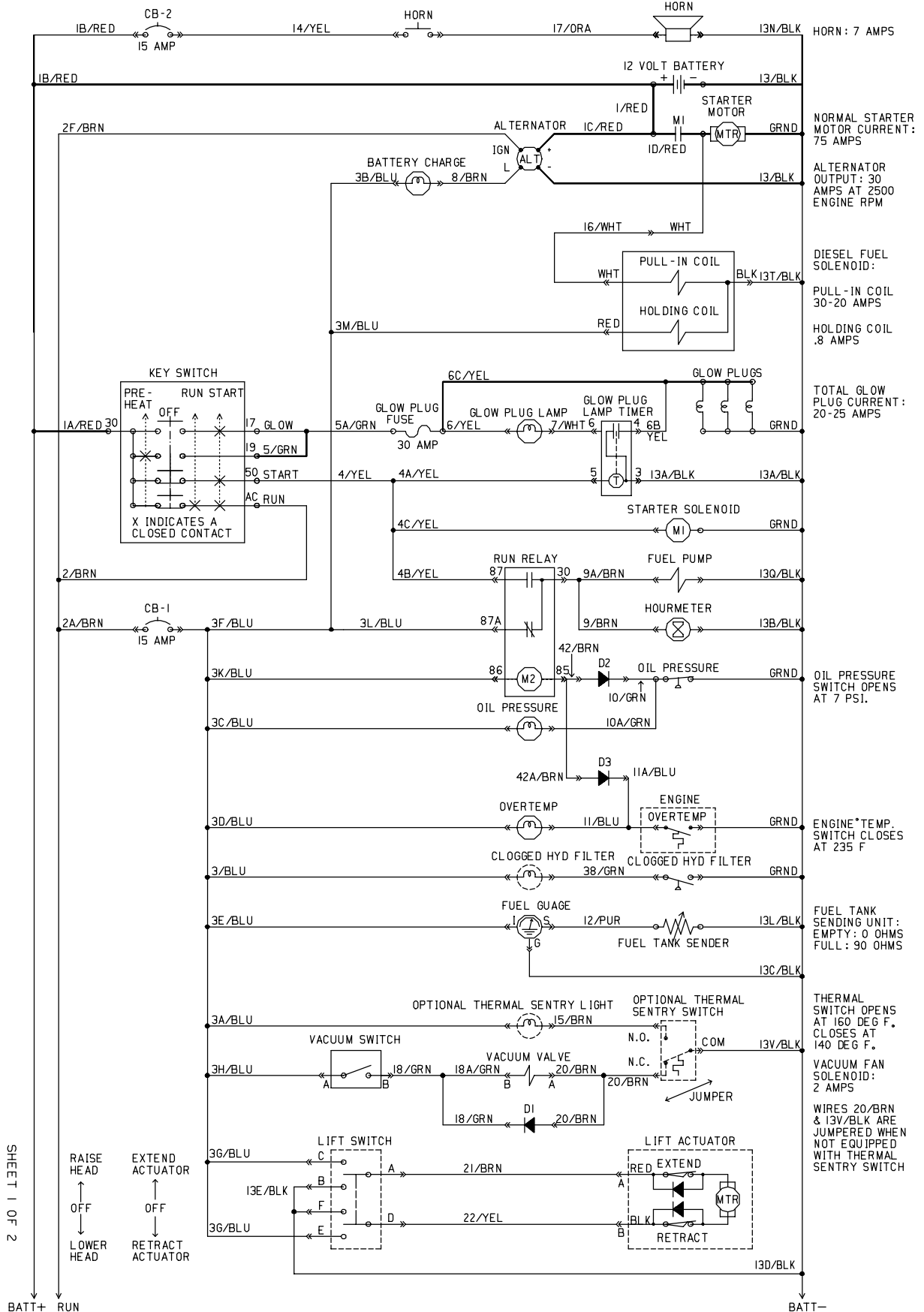

SHEET 1 OF 2

RAISE HEAD
OFF
LOWER HEAD

EXTEND ACTUATOR
OFF
RETRACT ACTUATOR

352281

ELECTRICAL SCHEMATIC

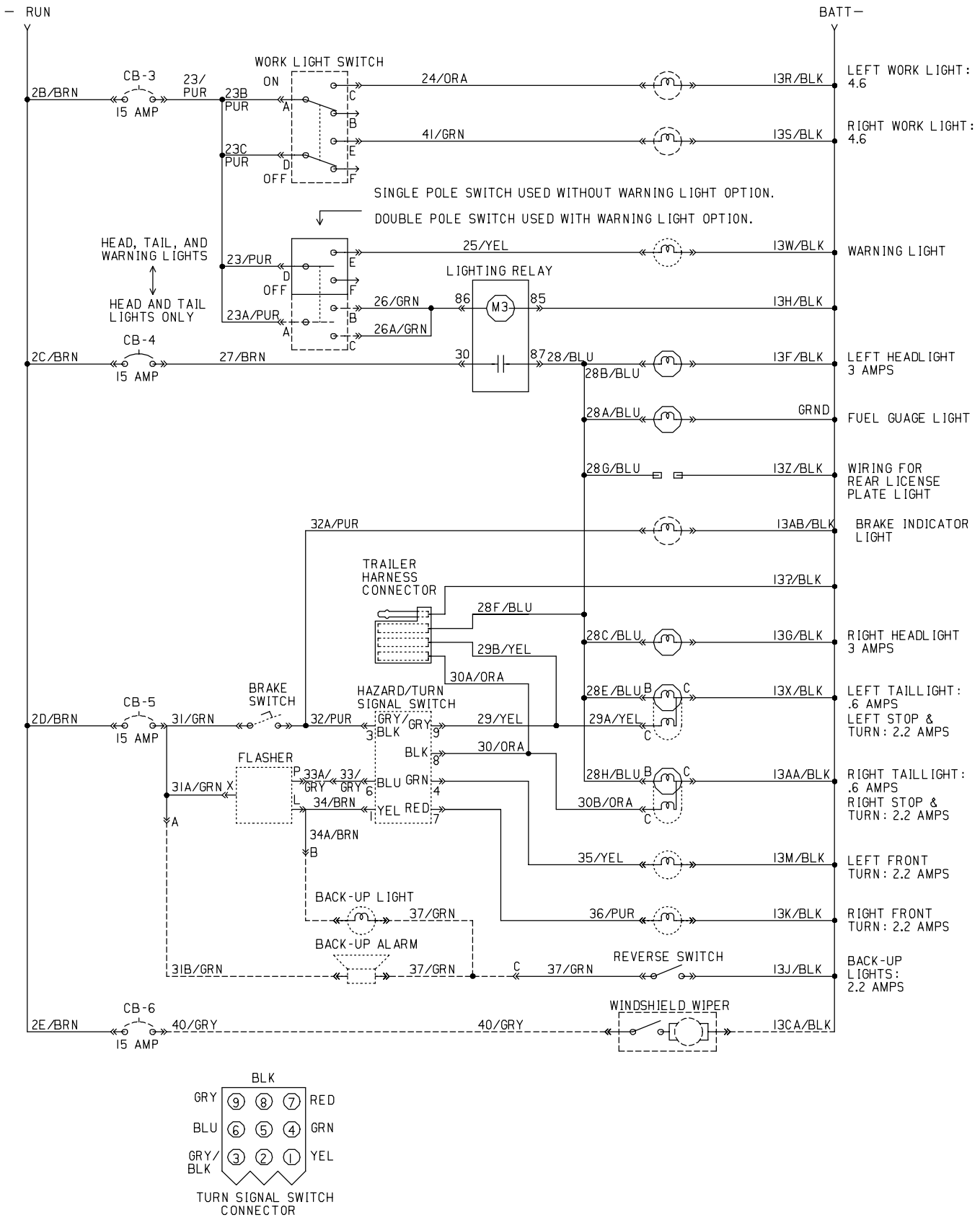

352281

WIRE HARNESS

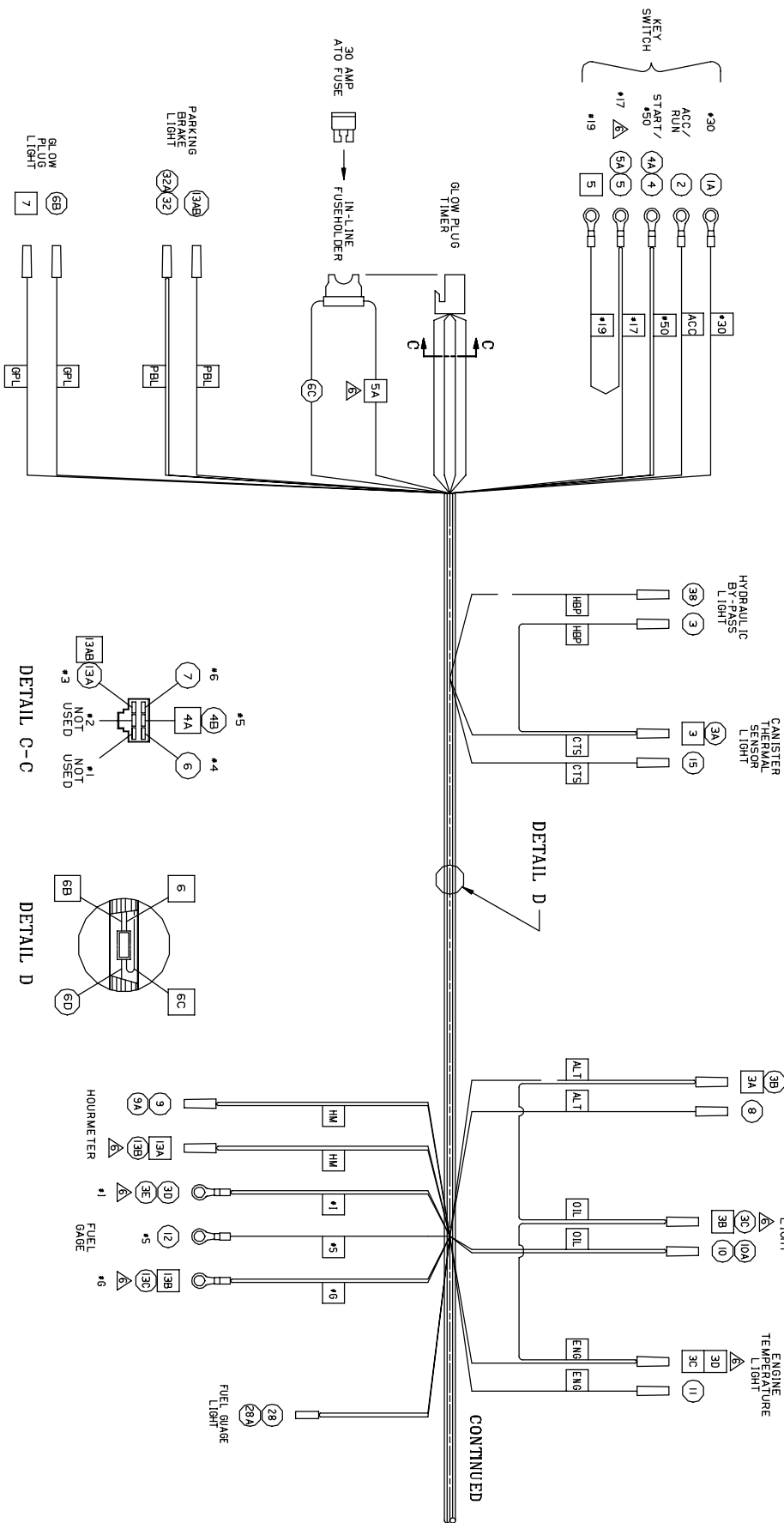

WIRE HARNESS

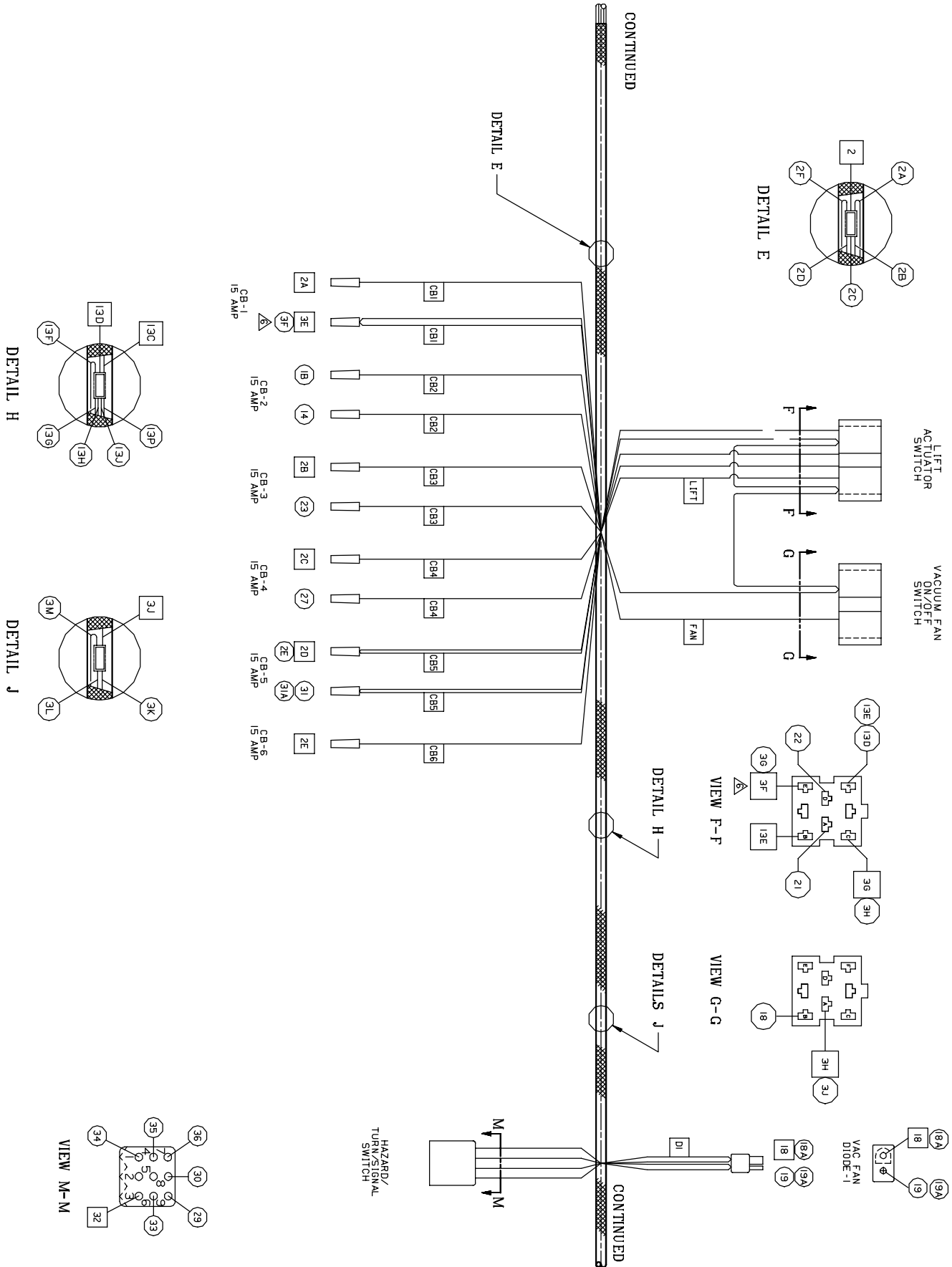

WIRE HARNESS

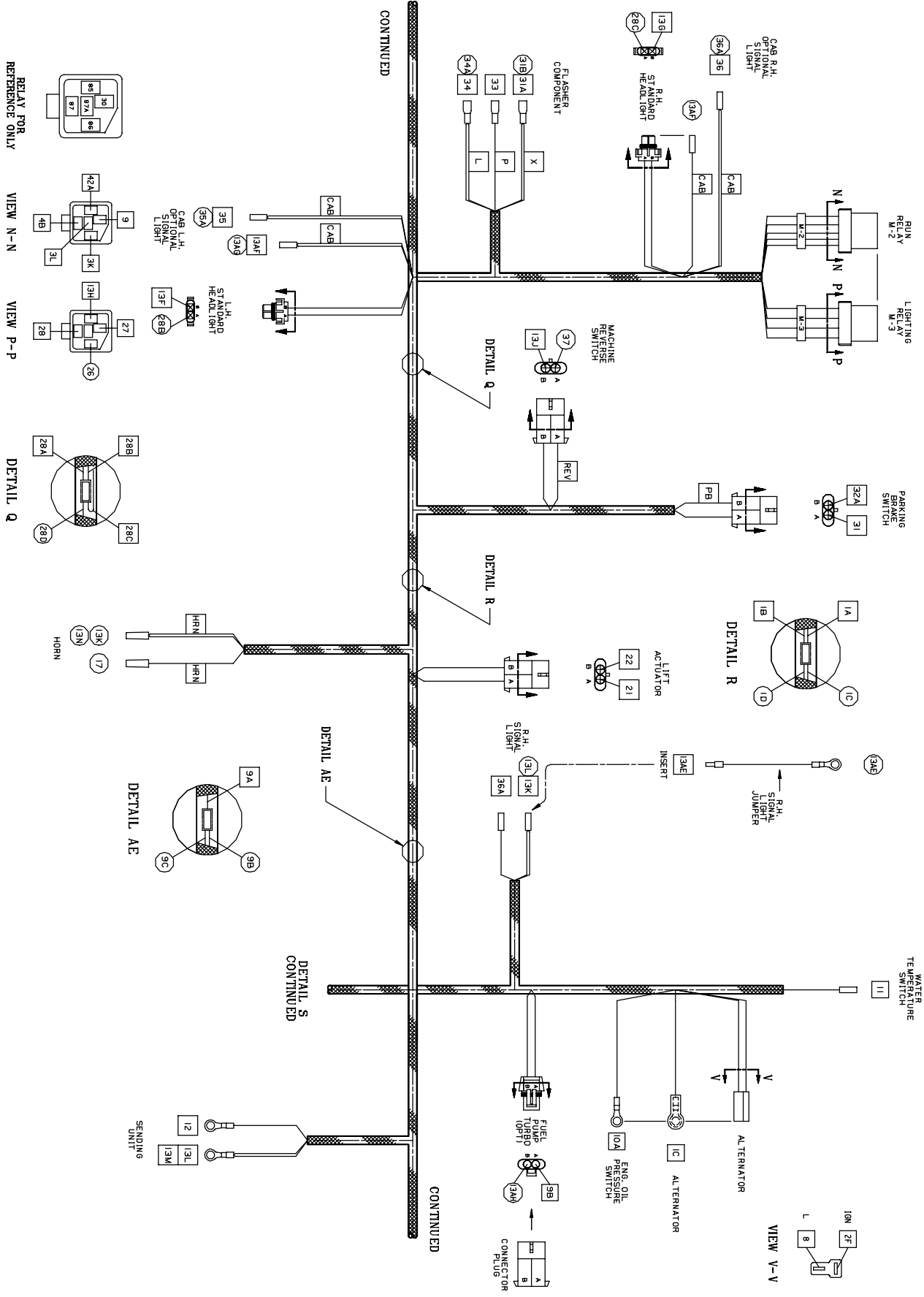

WIRE HARNESS

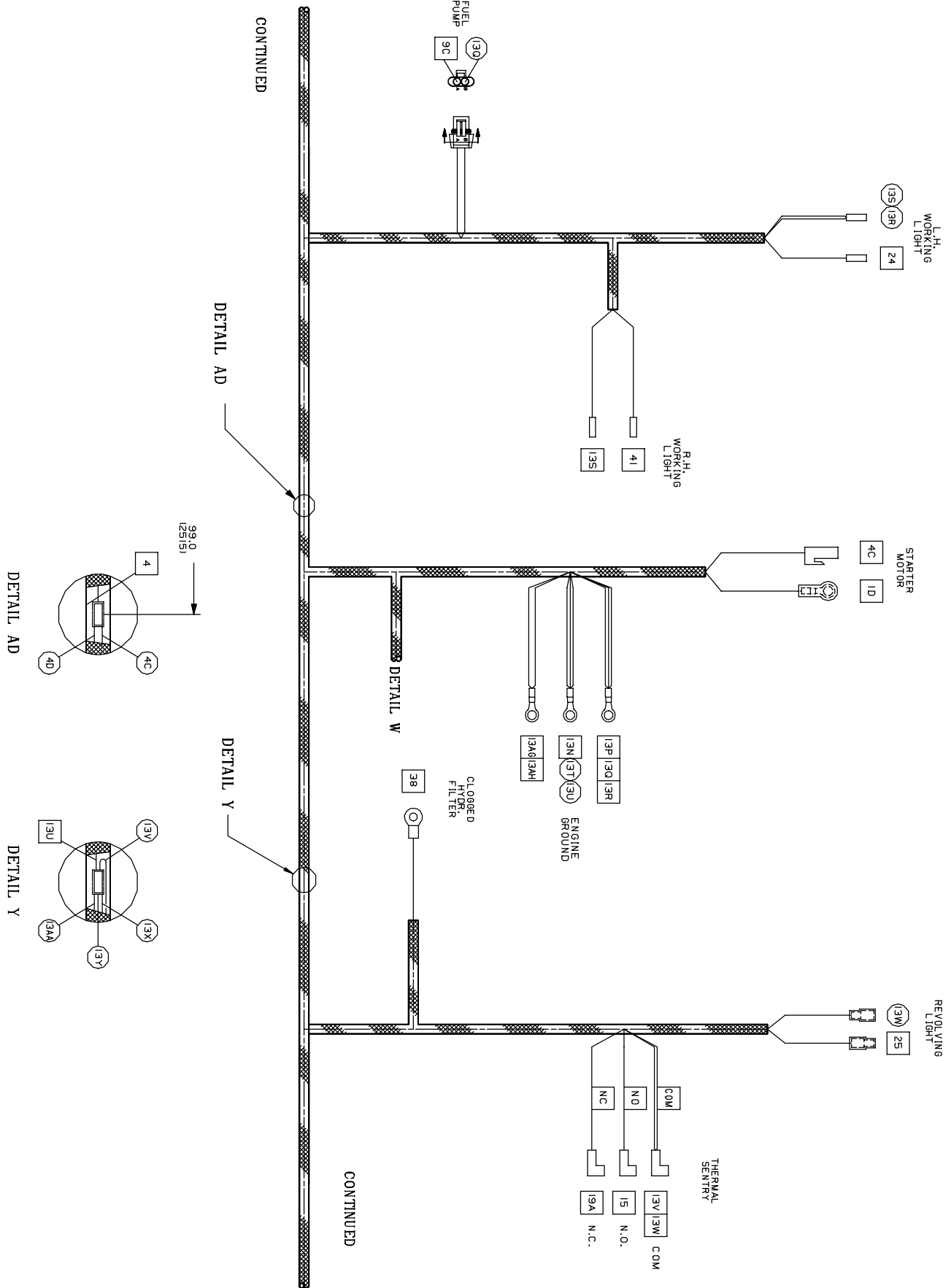

WIRE HARNESS

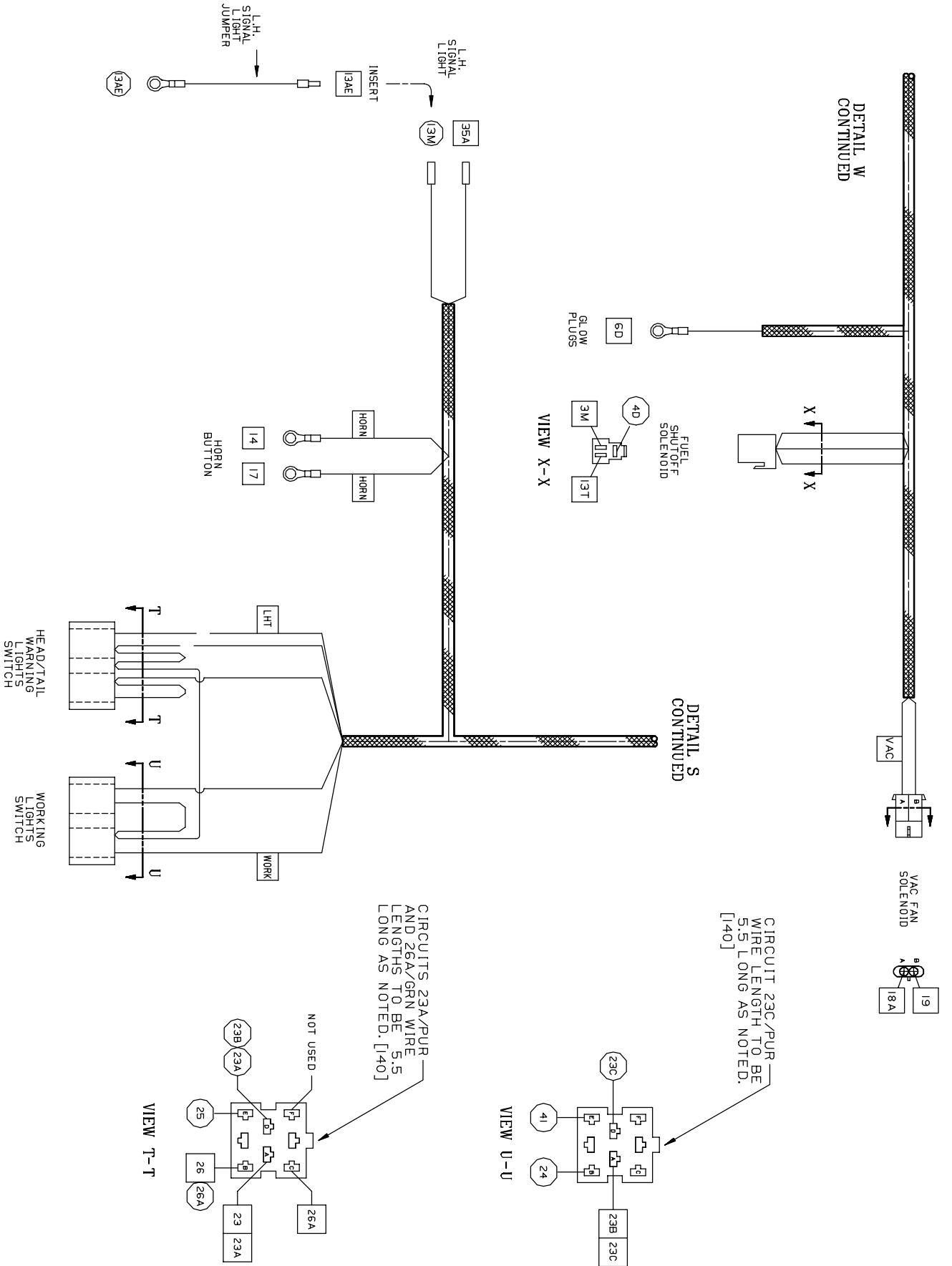

WIRE HARNESS

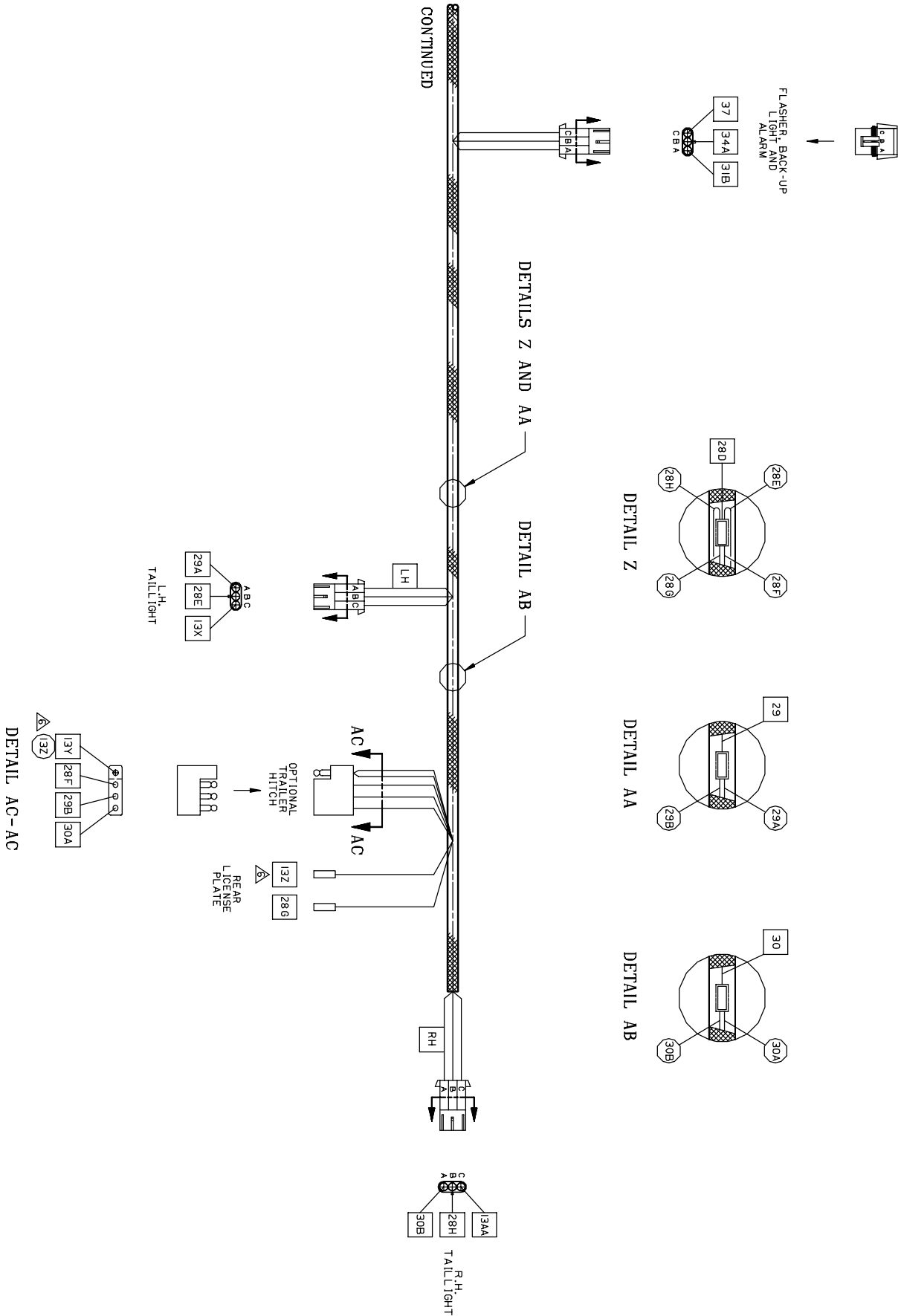

TROUBLESHOOTING

The troubleshooting charts that follow are organized so they lead you through the circuits. They include flow charts and instructions for you as to where to insert your test instruments.

ENGINE WILL NOT CRANK

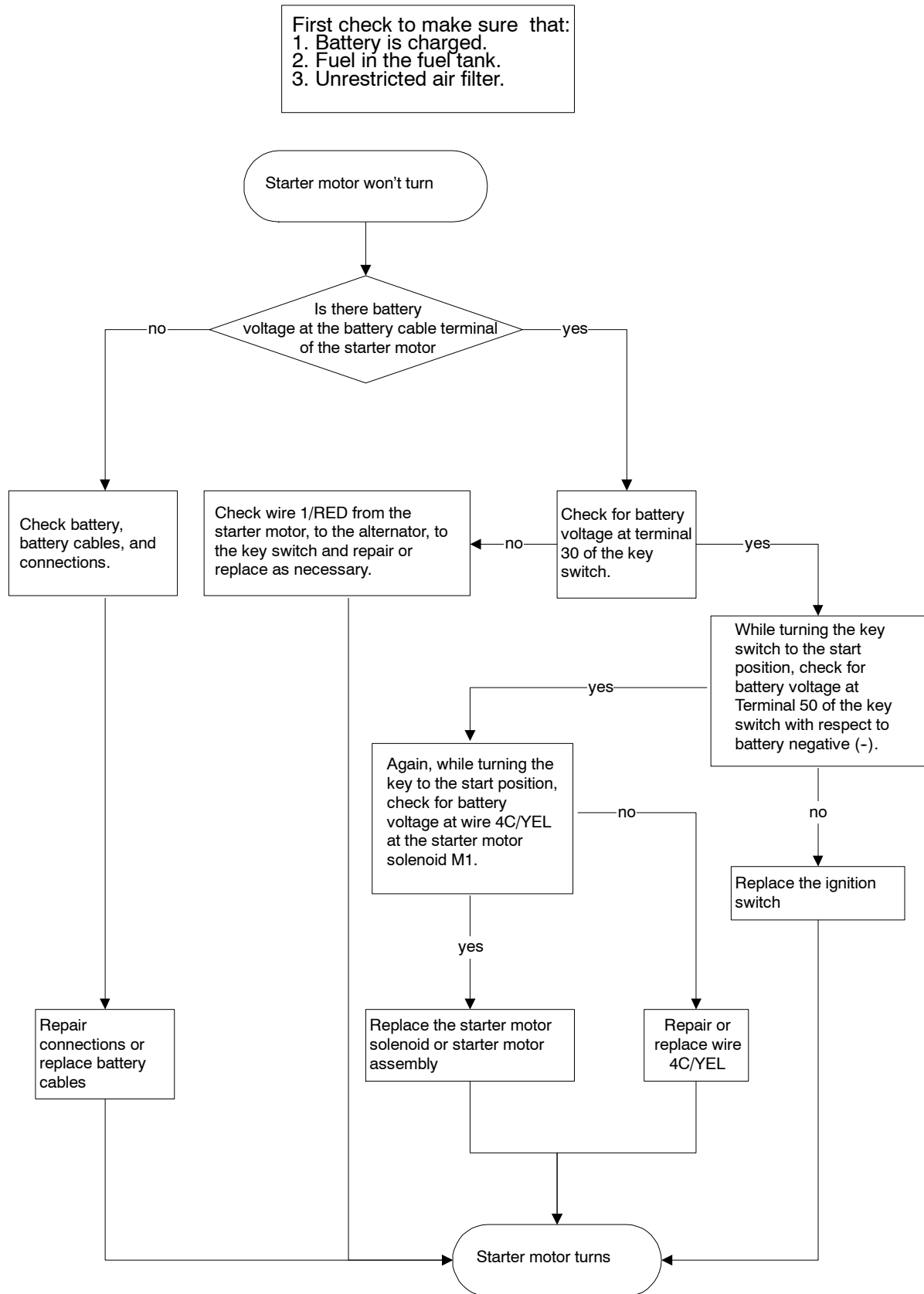

ENGINE WILL NOT RUN

- First check to make sure :
1. Battery is charged.
 2. Fuel in the fuel tank.
 3. Unrestricted air filter.
 4. Engine oil at full level.
 5. CB-1 is not tripped

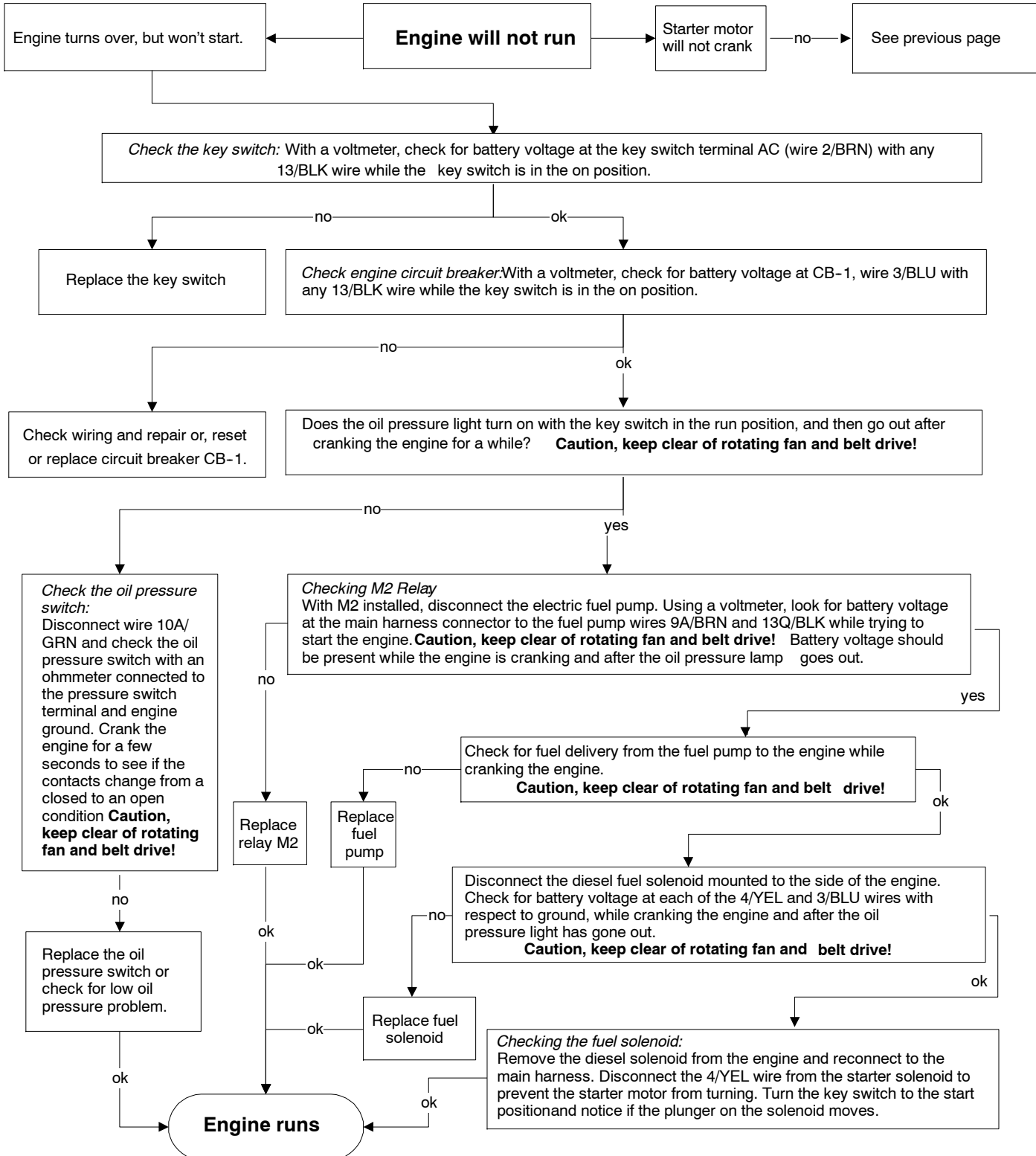

VACUUM FAN WILL NOT RUN

With the engine off , First check to make sure that:
 1. The vacuum fan rotates free.
 2. The hydraulic oil level is correct.
 3. The hopper is not full.

Is the optional thermal sentry light on?

no

yes

Checking for battery voltage to the vacuum fan switch:
 With the key switch in the on position **and the engine NOT running** , check for battery voltage between the 3//BLU wire at the vacuum fan switch and any 13//BLK wire.

Make sure the key switch is off with the engine NOT running, check for possible fire or high temperatures in the hopper cover area !!!

no battery voltage

battery voltage present

Reset or replace if defective, CB-1 circuit breaker.

Checking the vacuum switch:
 With the key switch in the on position **and the engine NOT running** , turn on the vacuum switch and check for battery voltage between wire 18//GRN at the vacuum switch and any 13//BLK wire..

no battery voltage

battery voltage present

Replace if the defective Vacuum fan switch.

Checking the thermal sentry switch:
 With the key switch in the on position **and the engine NOT running** , turn on the vacuum switch and check for battery voltage between wire 18//GRN at the vacuum switch and 20//BRN at the thermal sentry switch.

no battery voltage

battery voltage present

Replace if the defective thermal sentry switch.

Replace if the defective vacuum fan solenoid valve coil.

ok

ok

ok

Vacuum fan runs

HEAD LIFT WILL NOT OPERATE

First check to make sure :
 1. Battery is charged.
 2. Engine runs good.

This troubleshooting guide deals primarily with the optional head lift motorized linear actuator

Check to see that the head lift mechanism has not been damaged or prevented from traveling its normal range of movement.

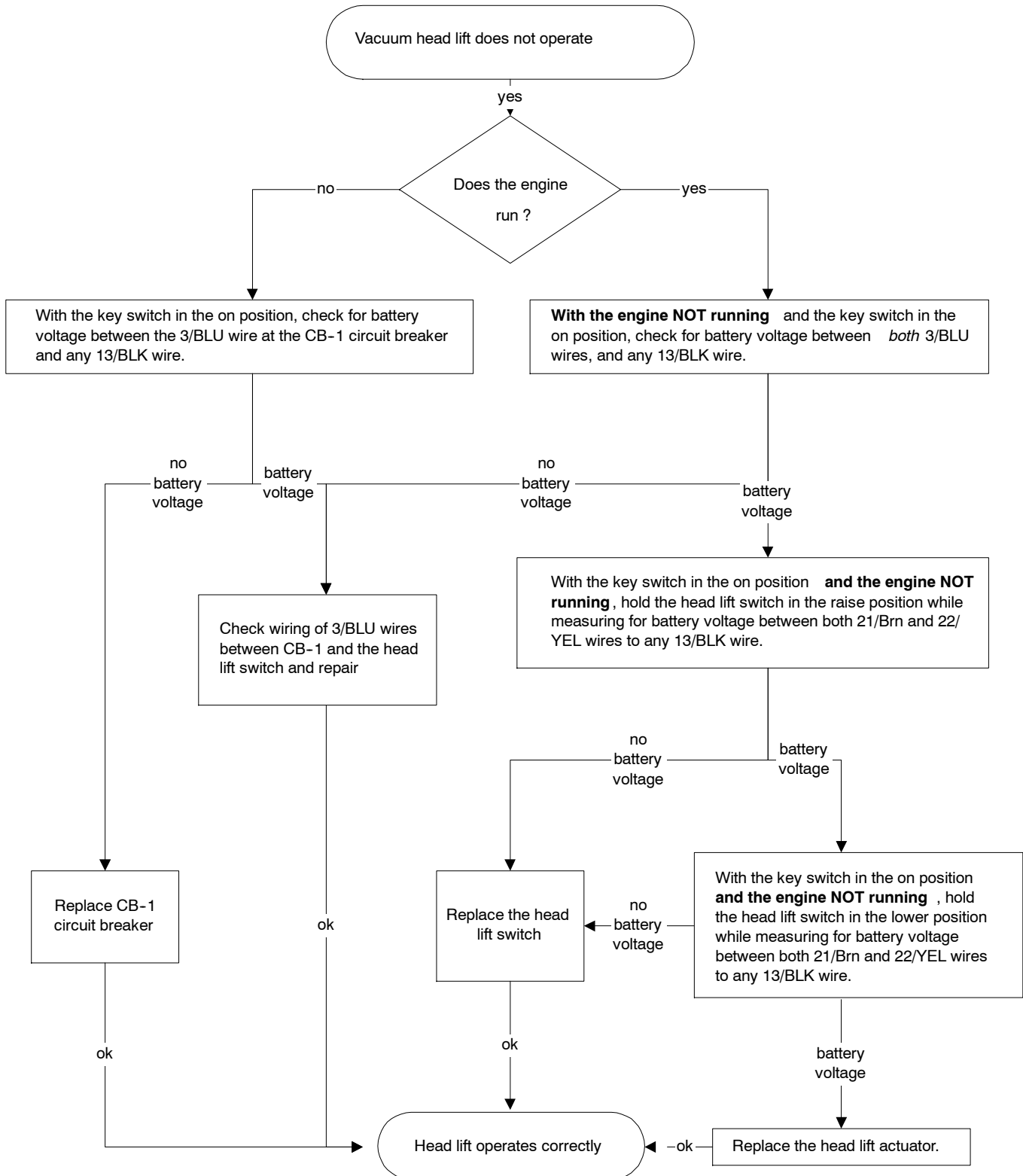

CONTENTS

	Page
INTRODUCTION	5-3
HYDRAULIC FLUID RESERVOIR	5-4
HYDRAULIC FLUID	5-5
HYDRAULIC HOSES	5-5
HYDRAULIC FLUID COOLER	5-6
HYDRAULIC FLUID FILTER	5-6
TO REPLACE HYDRAULIC FLUID FILTER	5-6
HYDRAULIC PUMPS	5-7
TO REPLACE PROPEL PUMP	5-7
TO REPLACE ACCESSORY PUMP ...	5-10
HYDRAULIC MOTORS	5-12
TO REPLACE VACUUM FAN MOTOR	5-12
TO REPLACE STEERING WHEEL MOTOR	5-15
TO REPLACE DRIVE WHEEL MOTOR	5-17
STEERING CYLINDER	5-19
TO REPLACE STEERING CYLINDER .	5-19
STEERING CYLINDER BREAKDOWN .	5-21
CONTROL VALVE	5-22
TO REPLACE SOLENOID CONTROL VALVE	5-22
HYDRAULIC SCHEMATIC	5-25
HYDRAULIC HOSE GROUP	5-26
TROUBLESHOOTING	5-27
EATON HYDRAULIC REPAIR MANUAL ...	5-33

INTRODUCTION

The hydraulic system consists of the propel pump, accessory pump, control valve, drive motors, steering cylinder, and vacuum fan motor.

HYDRAULICS

HYDRAULIC FLUID RESERVOIR

The reservoir is located on the left side of the machine next to the engine.

A filler cap is mounted on top of the reservoir. It has a built in breather and fluid level dipstick. Replace the cap after every 800 hours of operation.

Check the hydraulic fluid level at *operating temperature* daily. The dipstick is marked with full and add markings to indicate the level of hydraulic fluid in the reservoir. Cold fluid level is mid-point of add and full lines.

Lubricate the filler cap gasket with a film of hydraulic fluid before putting the cap back on the reservoir.

ATTENTION! Do not overfill the hydraulic fluid reservoir or operate the machine with a low level of hydraulic fluid in the reservoir. Damage to the machine hydraulic system may result.

Drain and refill the hydraulic fluid reservoir with new hydraulic fluid every 800 hours of operation.

NOTE: When the hydraulic filter bypass light (optional) comes on, replace the filter, and change the hydraulic fluid as soon as possible.

The hydraulic fluid filter is located in front of the hydraulic reservoir near the rear of the engine compartment. Replace the filter element every 800 hours of operation.

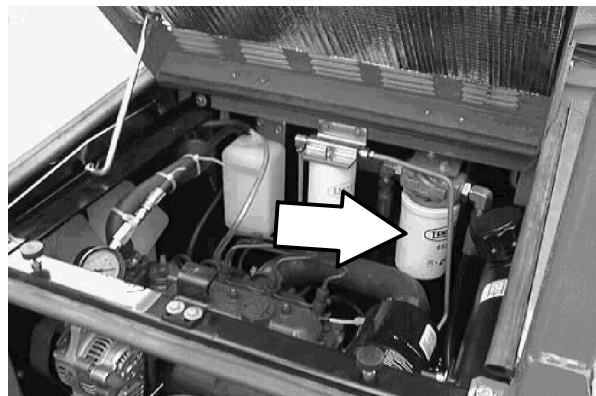
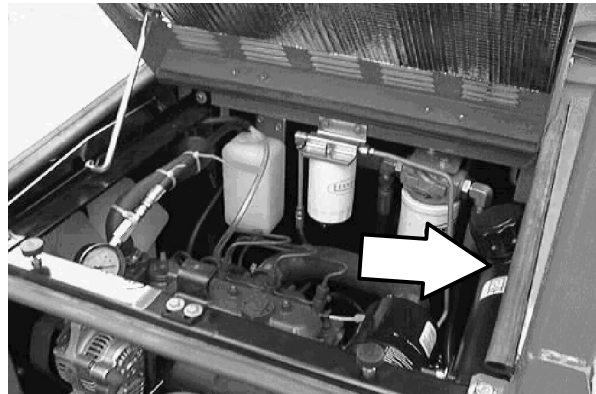
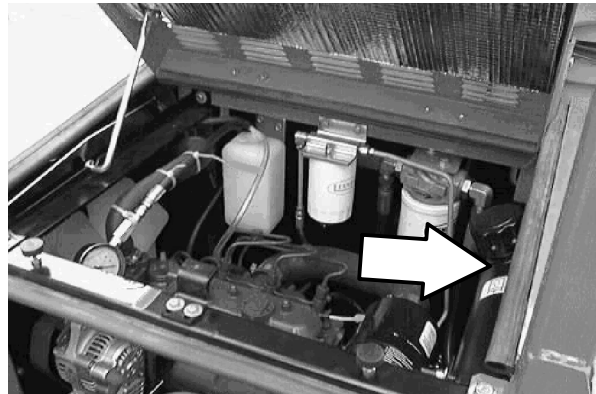

HYDRAULIC FLUID

The quality and condition of the hydraulic fluid plays a very important role in how well the machine operates. TENNANT's hydraulic fluid is specially selected to meet the needs of TENNANT machines.

TENNANT's hydraulic fluids provide a longer life for the hydraulic components. There are two TENNANT fluids available for different temperature ranges:

TENNANT part no.	Ambient Temperature
65869	above 7° C (45° F)
65870	below 7° C (45° F)

The higher temperature fluid has a higher viscosity and should not be used at the lower temperatures. Damage to the hydraulic pumps may occur because of improper lubrication.

The lower temperature fluid is a thinner fluid for colder temperatures.

If a locally-available hydraulic fluid is used, make sure the specifications match TENNANT hydraulic fluid specifications. Using substitute fluids can cause premature failure of hydraulic components.

ATTENTION! Hydraulic components depend on system hydraulic fluid for internal lubrication. Malfunctions, accelerated wear, and damage will result if dirt or other contaminants enter the hydraulic system.

HYDRAULIC HOSES

Check the hydraulic hoses every 200 hours of operation for wear or damage.

Fluid escaping at high pressure from a very small hole can be almost invisible, and can cause serious injuries.

See a doctor at once if injury results from escaping hydraulic fluid. Serious infection or reaction can develop if proper medical treatment is not given immediately.

FOR SAFETY: When Servicing Machine, Use Cardboard To Locate Leaking Hydraulic Fluid Under Pressure.

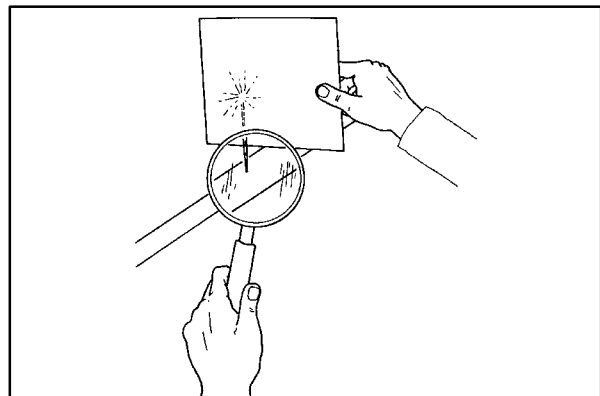

00002

If you discover a fluid leak, contact your mechanic/supervisor.

HYDRAULIC FLUID COOLER

The hydraulic fluid cooler is located on the outside of the engine radiator. Hydraulic fluid flows through the cooler when the machine is running. Airflow from the engine fan cools the fluid.

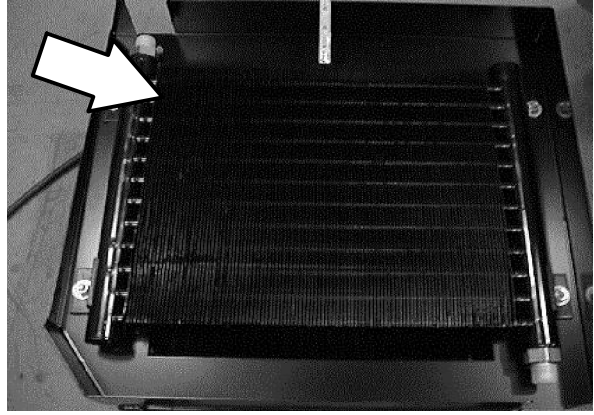

HYDRAULIC FLUID FILTER

The hydraulic fluid filter is located on the left side of the machine frame, behind the engine. The filter is used to keep the fluid free from contaminants. The filter should be changed every 800 hours.

TO REPLACE HYDRAULIC FLUID FILTER

FOR SAFETY: Before Leaving Or Servicing Machine; Stop On Level Surface, Set Parking Brake, turn off machine, and remove key.

1. Open the hopper cover and tilt the hopper back.
2. Open the top engine cover.
3. Remove the five pan screws holding the rear engine cover to the machine. Remove the cover.
4. Locate the hydraulic fluid filter on the left side of the upper machine frame. Place a drain pan under the filter, on top of the muffler guard.
5. Un-screw the filter from the filter head. Properly discard the old filter.
6. Place a small amount of hydraulic oil on the rubber O-ring on the new filter.
7. Screw the new filter onto the filter head. Tighten until snug then 1/4 turn.
8. Reinstall the rear engine cover.
9. Remove the drain pan. Tilt the hopper forward and close the hopper cover.
10. Start the machine and check the new hydraulic fluid filter for any leaks.

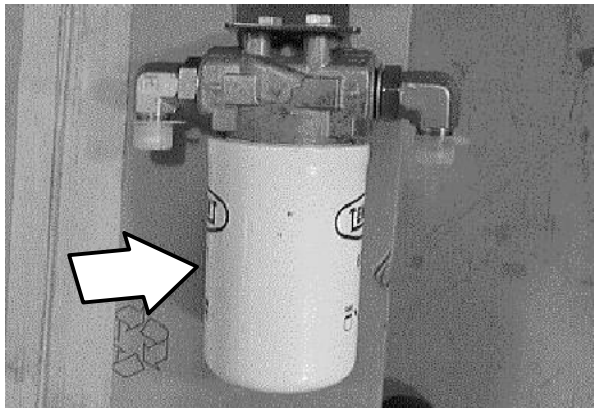
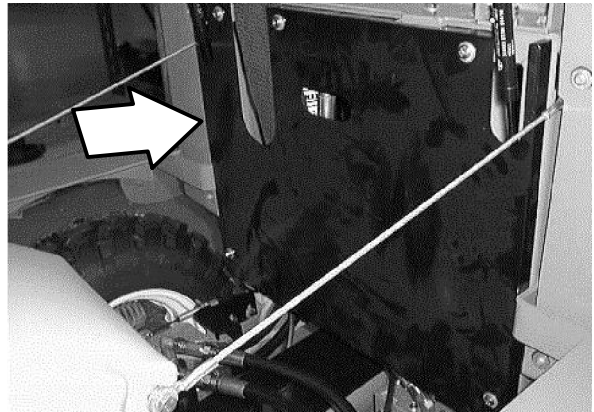
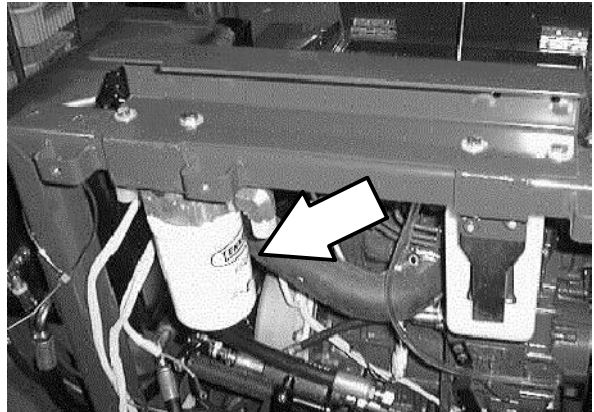

HYDRAULIC PUMPS

The propel pump is used to provide hydraulic flow to the drive motors. The accessory pump is used to provide flow to the vacuum fan and steering circuit.

TO REPLACE PROPEL PUMP

FOR SAFETY: Before Leaving Or Servicing Machine; Stop On Level Surface, Set Parking Brake, turn off machine, and remove key.

1. Open the hopper cover and tilt the hopper back.
2. Open the top engine cover.
3. Remove the five pan screws holding the rear engine cover to the machine. Remove the cover.
4. Remove the grill from the left side fender panel.
5. Disconnect the air intake tube from the collar on the left side machine fender.
6. Remove the seven pan screws holding the left fender to the machine. Pull the fender out slightly and disconnect the turn signal. Remove the fender from the machine.

NOTE: Observe hydraulic cleanliness requirements when opening hydraulic lines.

7. Disconnect and plug the small hydraulic hose leading to the back side of the accessory pump. Leave the larger suction line connected.
8. Remove the two cap screws holding the accessory pump to the propel pump. Pull the accessory pump straight back out of the propel pump. Let the accessory pump drop down out of the way for access to the propel pump.

NOTE: Make sure to retain the O-ring.

9. Locate the propel pump directional arm on the back side of the propel pump. Remove the two hex screws holding the pump arm to the pump hub.

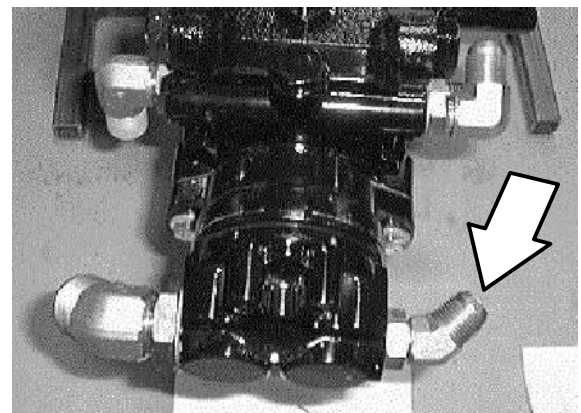
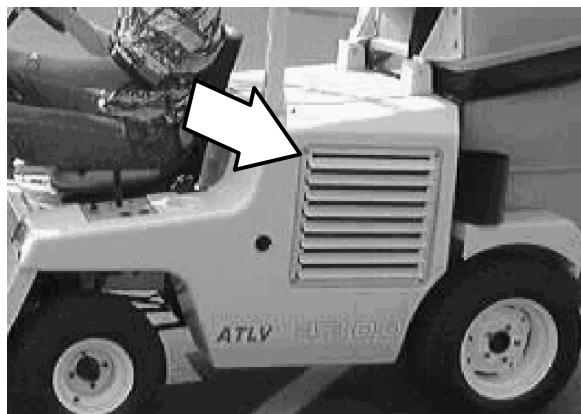
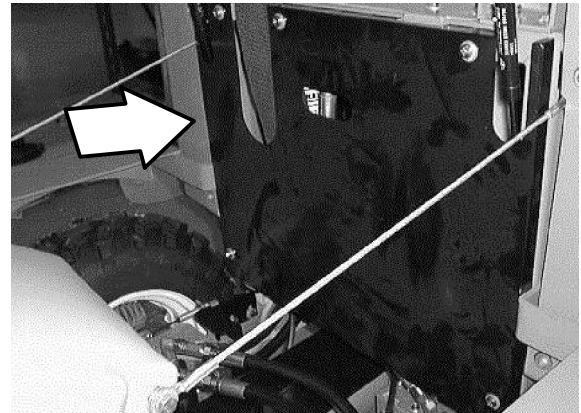
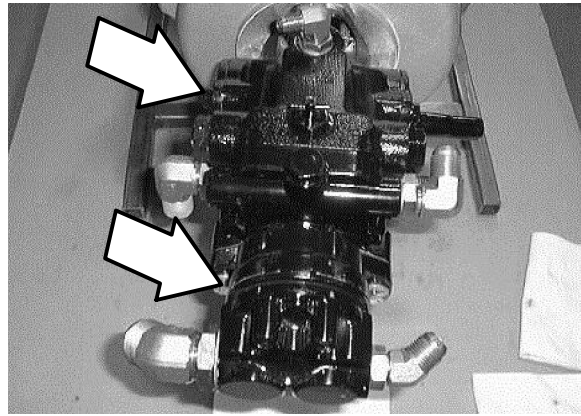

HYDRAULICS

10. Mark, disconnect, and plug the four hydraulic hoses leading to the propel pump.
11. Remove the two hex screws holding the propel pump to the bellhousing.

NOTE: The bottom hex screw can be accessed easier with the motor mount removed.

12. Pull the propel pump out of the bellhousing and remove it from the machine.
13. Remove the directional hub from the side of the propel pump and install on the new pump in the same orientation. Use blue loctite (242) on the threads of the cap screw. Tighten to 18 - 24 Nm (15 - 20 ft. lb).
14. Remove the hydraulic fittings from the old propel pump and install into the new pump in the same orientation.
15. Position the new pump assembly into the engine bellhousing. Line up splines on the pump input shaft with the teeth in the flywheel coupling. Push the pump in until it is against the bellhousing plate.

16. Reinstall the two hex screws into the pump mount holes. Tighten to 31 - 40 Nm (27 - 35 ft. lb).

NOTE: The pump directional hub faces the rear of the machine.

17. Reconnect the four hydraulic hoses to the propel pump. See hose diagram in this section.

NOTE: Observe hydraulic cleanliness requirements when opening hydraulic lines.

18. Reinstall the accessory pump into the propel pump. Make sure the O-ring is installed on the face of the pump. Reinstall the hardware and tighten to 31 - 40 Nm (27 - 35 ft. lb).
19. Reconnect the one small hydraulic hose to the accessory pump. See hose diagram in this section.

NOTE: Observe hydraulic cleanliness requirements when opening hydraulic lines.

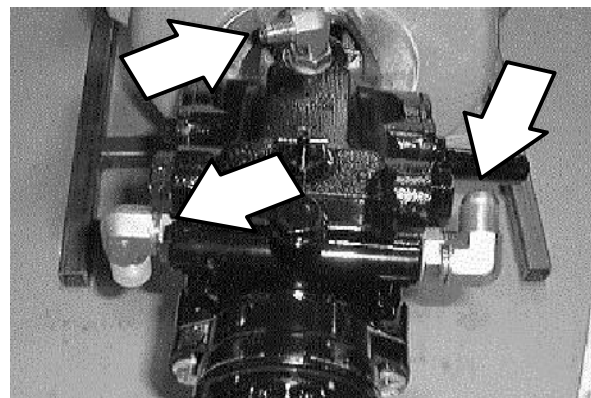
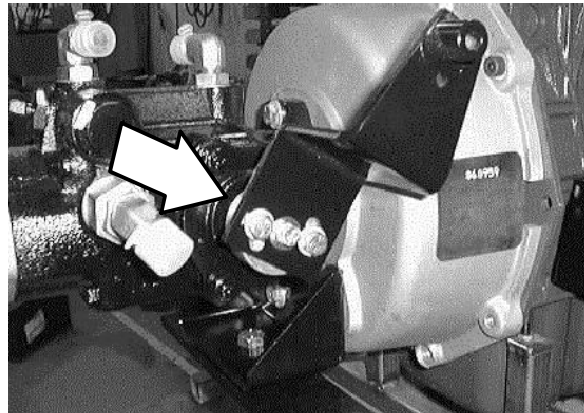
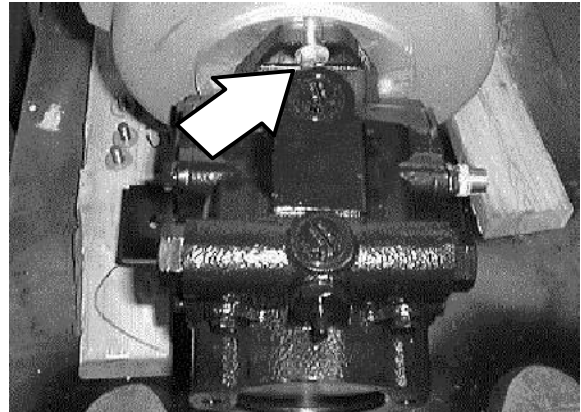
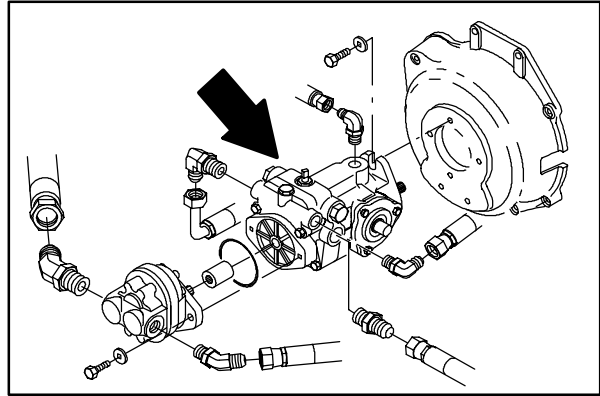

20. Reinstall the directional pump arm onto the pump hub. Reinstall the two hex screws. Leave the screws loose for now.
21. The neutral centering will have to be set at this point. See TO ADJUST PROPEL NEUTRAL instructions in the CHASSIS section.
22. Reinstall the left hand side panel and left hand grill.
23. Reinstall the rear engine cover.
24. Tilt the hopper forward, close the hopper cover, and close the top engine cover.
25. Start the machine and operate the propel circuit. Check for proper operation.

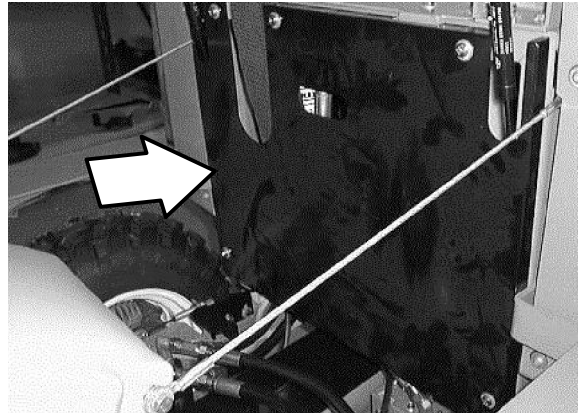
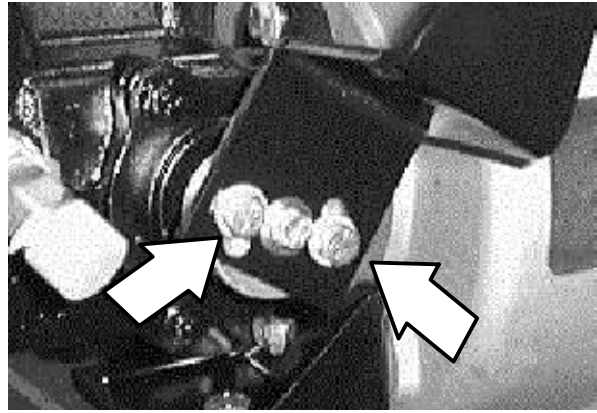

HYDRAULICS

TO REPLACE ACCESSORY PUMP

FOR SAFETY: Before Leaving Or Servicing Machine; Stop On Level Surface, Set Parking Brake, turn off machine, and remove key.

1. Open the hopper cover and tilt the hopper back.
2. Open the top engine cover.
3. Remove the five pan screws holding the rear engine cover to the machine. Remove the cover.
4. Remove the grill from the left side fender panel.
5. Disconnect the air intake tube from the collar on the left side machine fender.
6. Remove the seven pan screws holding the left fender to the machine. Pull the fender out slightly and disconnect the turn signal. Remove the fender from the machine.

NOTE: Observe hydraulic cleanliness requirements when opening hydraulic lines.

7. Disconnect and plug the two hydraulic hoses leading to the accessory pump.

NOTE: The hydraulic fluid reservoir must be drained or a suction device used to minimize fluid lose.

8. Remove the two cap screws holding the accessory pump to the propel pump. Pull the accessory pump straight back out of the propel pump.

NOTE: Make sure to retain the O-ring.

9. Remove the hydraulic fittings from the old accessory pump and install into the new pump in the same orientation.

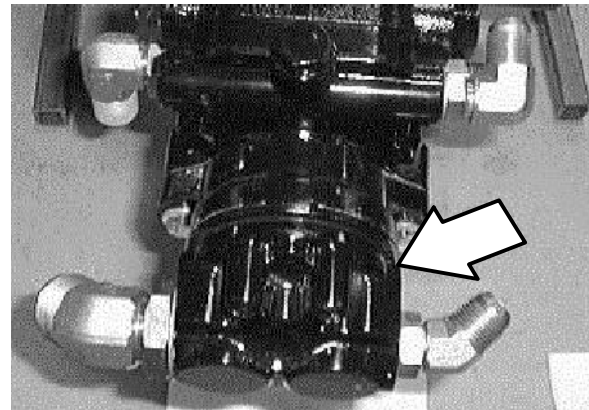
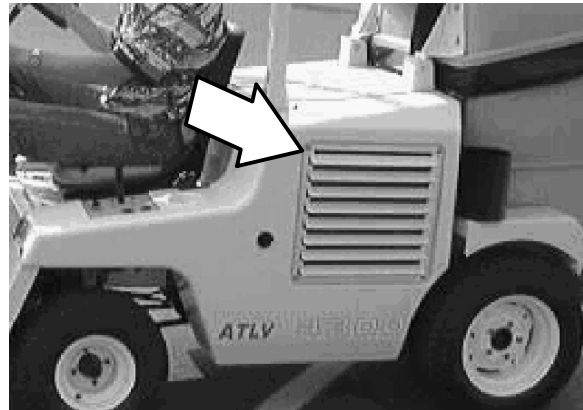
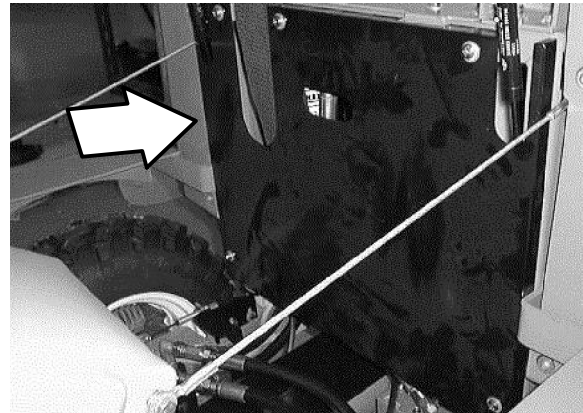
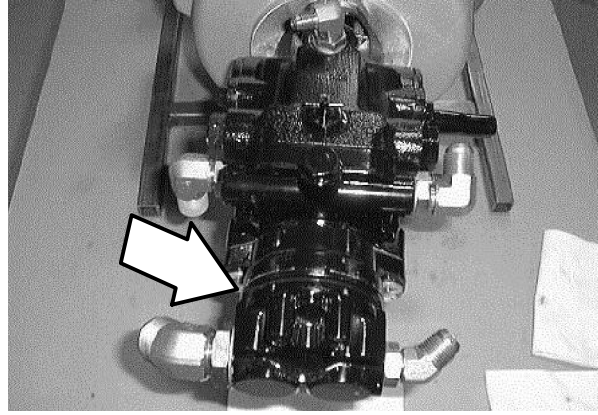

10. Reinstall the accessory pump into the propel pump. Make sure the O-ring is installed on the face of the pump. Reinstall the hardware and tighten to 31 - 40 Nm (27 - 35 ft. lb).
11. Reconnect the two hydraulic hose to the accessory pump. See hose diagram in this section.

NOTE: Observe hydraulic cleanliness requirements when opening hydraulic lines.

12. Reinstall the left hand side panel and left hand grill.
13. Tilt the hopper forward, close the hopper cover, and close the top engine cover.
14. Start the machine and operate the hydraulic circuit. Check for proper operation.

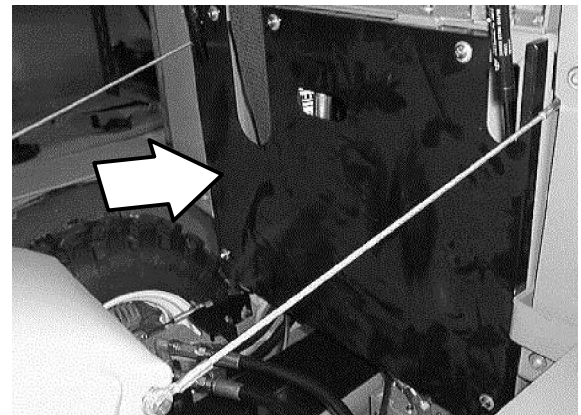
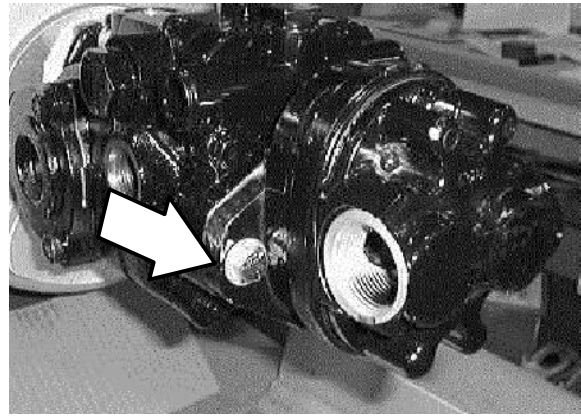

HYDRAULIC MOTORS

The vacuum fan impeller is driven by a hydraulic motor located on top of the hopper cover. The vacuum fan motor is controlled by a solenoid valve located on the machine frame.

The steering wheel motor is used to provide hydraulic flow to the steering cylinder.

The drive wheel motors propel the machine forward and reverse. The propel pump provides hydraulic flow to the drive motors.

TO REPLACE VACUUM FAN MOTOR

FOR SAFETY: Before Leaving Or Servicing Machine; Stop On Level Surface, Set Parking Brake, turn off machine, and remove key.

NOTE: Anytime hopper or vacuum system parts are serviced the seals should be inspected and replaced if necessary.

1. Remove the six screws holding the vacuum fan motor cover plate to the top of the plenum assembly on top of the hopper cover. Remove the plate.

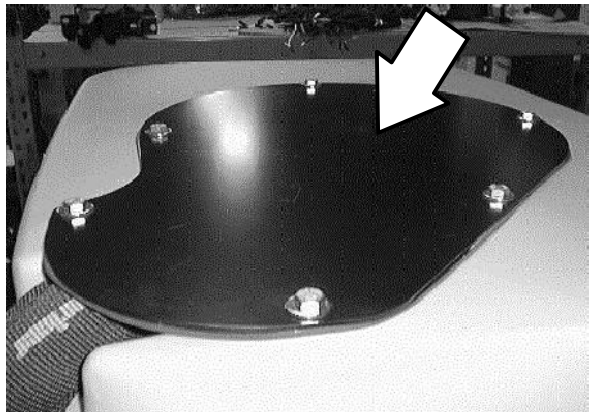

NOTE: Observe hydraulic cleanliness requirements when opening hydraulic lines.

2. Mark, disconnect, and plug the hydraulic lines leading to the vacuum fan motor.
3. Open the hopper cover and tilt the hopper back.
4. Go under the hopper cover and remove the six hex screws holding the cover assembly to the hopper cover. Remove the cover assembly.
5. Locate the vacuum fan impeller screen. Remove the three flat head screws and one hex screw holding the screen to the impeller.
6. Pull the impeller screen, spacer, and sleeve off the vacuum fan motor shaft.
7. Remove the four hex screws holding the vacuum fan assembly retainer plate to the bottom of the hopper cover.
8. Go to the top of the hopper cover and remove the vacuum fan assembly from the machine. Set the assembly up side down on a flat surface.

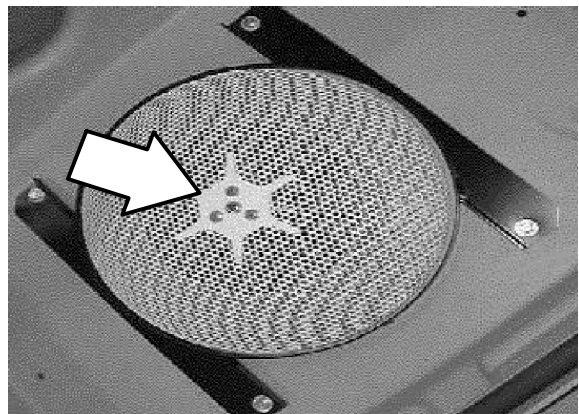
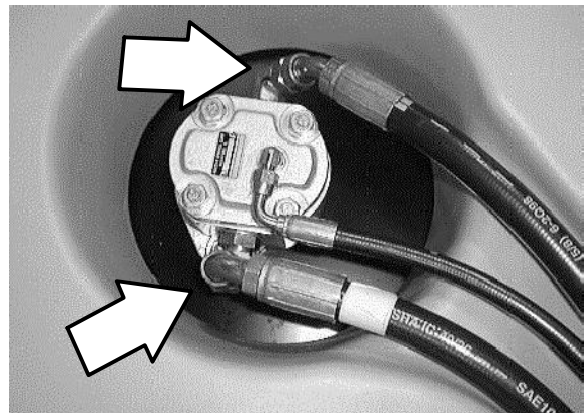

9. Pull the vacuum fan impeller off the fan motor shaft. Retain the key from the motor shaft.
10. Remove the two hex screws and nyloc nuts holding the vacuum fan motor to the mount plate. Remove the motor.

NOTE: The orientation of the motor ports and the reference hole in the mount plate.

11. Remove the hydraulic fittings from the old motor and install in the new motor in the same orientation.
12. Position the new motor assembly on the mount plate in the same orientation as the old one. Reinstall the hardware and tighten to 37 - 48 Nm (26 - 34 ft. lb).

NOTE: The orientation of the motor ports and the reference hole in the mount plate.

13. Install the vacuum fan impeller onto the motor shaft.

NOTE: Make sure to use the key that was removed with the old impeller.

14. Turn the assembly over and place it back on top of the hopper cover. Hold the impeller in place while turning over. Line up the holes in the motor bracket with the holes in the cover.
15. Go under the hopper cover and install the four hex screws into vacuum fan assembly retainer plate. Leave the hardware loose for now. Use blue loctite (242) on the threads of this hardware.
16. Reinstall the impeller screen, spacer, and sleeve onto the vacuum fan motor shaft.
17. Use blue loctite (242) on the threads of the impeller screen hardware. Reinstall the one M8 hex screw and three M6 flat screws.
18. Tighten the M8 hex screw to 18 - 24 Nm (15 - 20 ft. lb) and the M6 flat screws to 8 - 10 Nm (6 - 8 ft. lb).

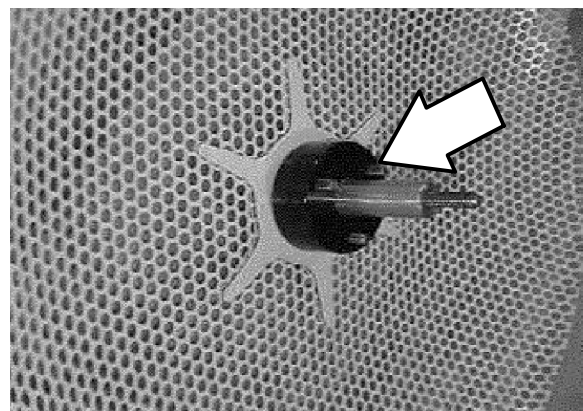
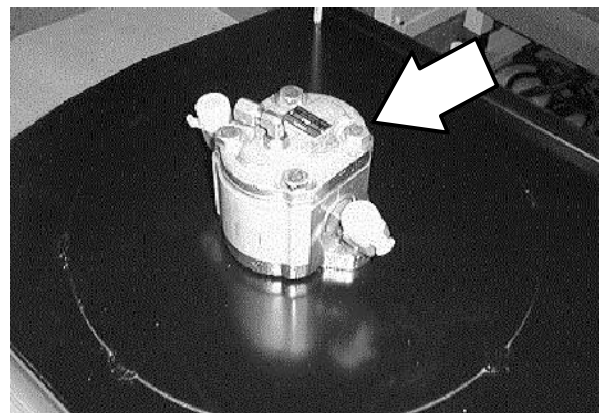
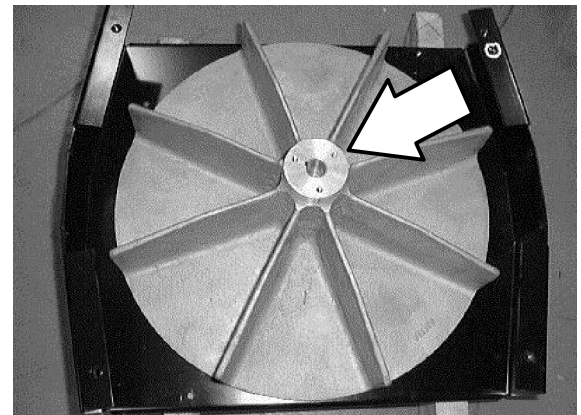
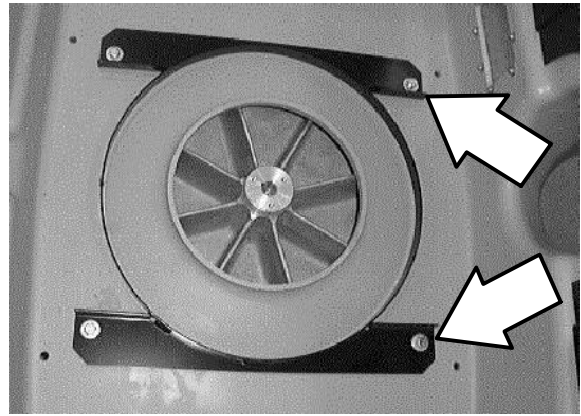

HYDRAULICS

19. After the screen has been tighten down, center the string guard (on the retainer plate) around the outside of the screen. Tighten the four screws to 18 - 24 Nm (15 - 20 ft. lb).
20. Reinstall cover assembly onto the hopper plenum.
21. Reinstall six hex screws holding the cover assembly to the hopper plenum. Tighten the screws to 18 - 24 Nm (15 - 20 ft. lb). Use blue loctite (242) on the threads of this hardware.

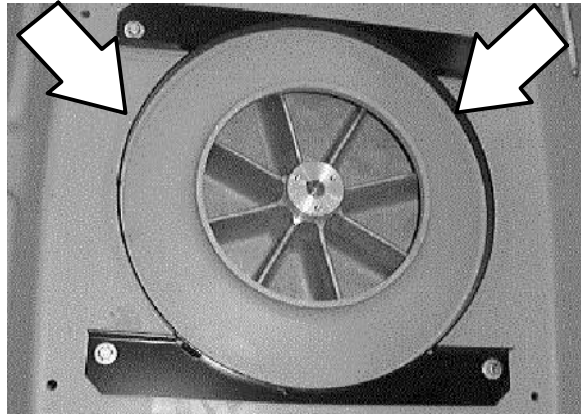

NOTE: Observe hydraulic cleanliness requirements when opening hydraulic lines.

22. Reconnect the hydraulic lines leading to the vacuum fan motor. See hydraulic schematic in this section.
23. Reinstall the six screws holding the vacuum fan motor cover plate to the top of the plenum assembly on top of the hopper cover. Tighten the screws to 18 - 24 Nm (15 - 20 ft. lb).
24. Tilt the hopper forward and close the cover.
25. Operate the machine and check the vacuum fan for proper operation.

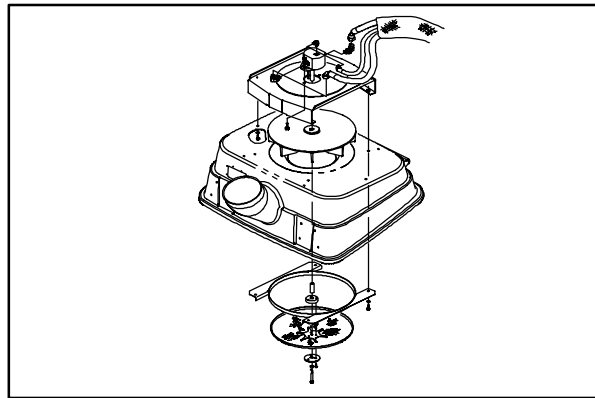
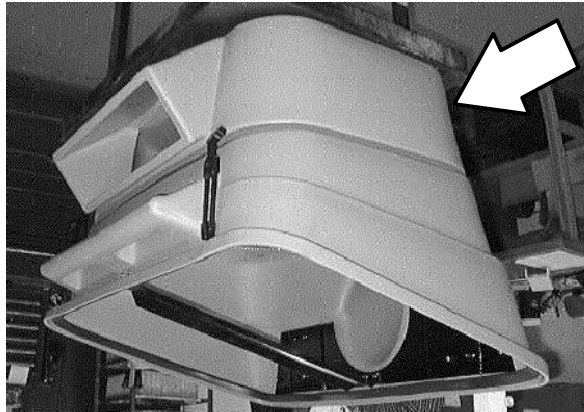

TO REPLACE STEERING WHEEL MOTOR

FOR SAFETY: Before Leaving Or Servicing Machine; Stop On Level Surface, Set Parking Brake, turn off machine, and remove key.

1. Open the seat support and engage the prop rod.
2. Locate the battery at the center of the machine, on top and ahead of the front axle.
3. Remove the battery negative cable.
4. Disengage the prop rod and lower the seat support.
5. Remove the cap from the center of the steering wheel (snap out).
6. Remove the M20 hex nut from the center of the steering wheel.
7. Use a puller to remove the steering wheel from the steering column.
8. Remove the knob from the tilt steering wheel pull lever.
9. If the machine is equipped with turn signals, remove the turn signal unit from the steering column.
10. Remove the two smaller pan screws from the top side of the instrument panel.
11. Remove the two larger pan screws from the back side of the instrument panel.
12. Carefully pull the instrument panel up until the rubber boot clears the steering column.
13. Place the instrument panel back, against the kick panel of the operators compartment.

NOTE: Observe hydraulic cleanliness requirements when opening hydraulic lines.

14. Mark, disconnect, and plug the five hydraulic hoses leading to the steering wheel motor.
15. Loosen the hardware holding the lock collars to the tilt bracket. Pull the steering wheel motor and column down until the four hex screws are accessible.
16. Remove the four M6 hex screws holding the steering column to the motor. Remove the motor from the machine. Note the orientation of the motor and fittings.

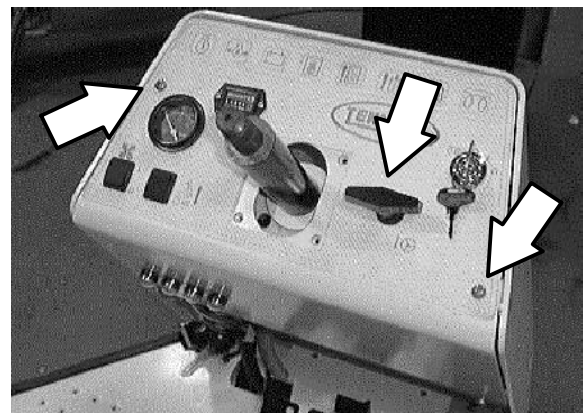
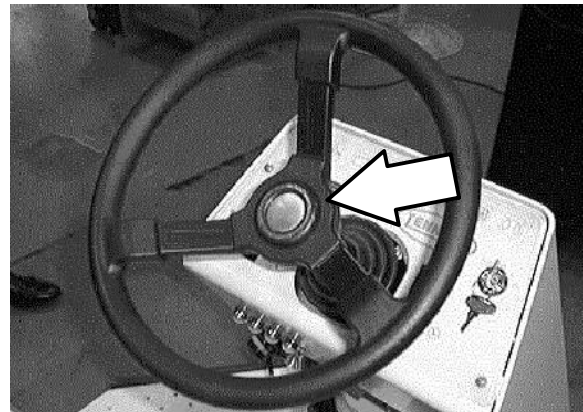
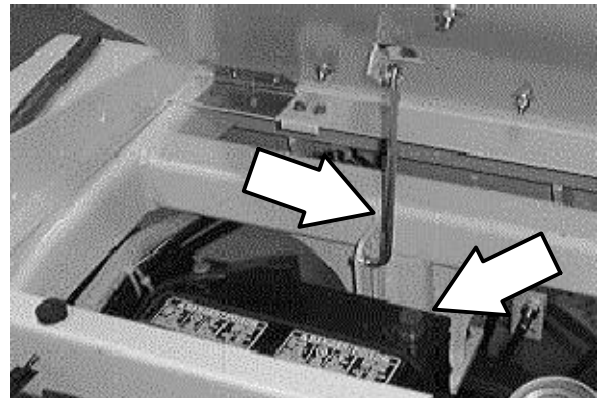
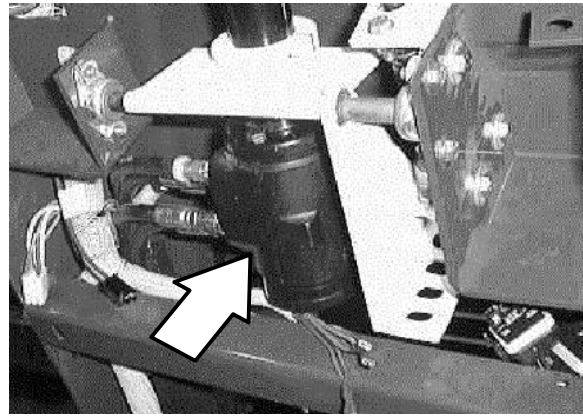

HYDRAULICS

17. Remove the five hydraulic fittings from the motor and install in the new steering wheel motor.
18. Install the new steering wheel motor assembly in the machine in the same orientation as the old one.
19. Reinstall the four M6 hex screws and tighten to 8 - 10 Nm (6 - 8 ft. lb).
20. Push the motor and column back up in position. Tighten the locking collars to 8 - 10 Nm (6 - 8 ft. lb).
21. Connect the five hydraulic hoses to the new steering wheel motor. See hose diagram in this section.
22. Position the instrument panel and rubber boot over the top of the steering column.

NOTE: Be careful not to tear the boot.

23. Push the panel down until the four mount holes line up with the weldnuts.
24. Reinstall the two small pan screws on top of the panel and the two larger pan screws on the back side of the panel. Hand tighten tight.
25. Reinstall the tilt steering rod knob. Turn the knob down tight.
26. Reinstall the steering wheel and M20 nut. Tighten tight.
27. Reinstall the cap in the center of the steering wheel (snap in).
28. Reinstall the turn signal assembly if the machine is equipped with road light option.
29. Open the seat support and engage the prop rod.
30. Reconnect the battery cable to the battery (*red cable to positive post, black cable to negative post*).
31. Disengage the prop rod and lower the seat support.
32. Start the machine and check for proper operation.

NOTE: Observe hydraulic cleanliness requirements when opening hydraulic lines.

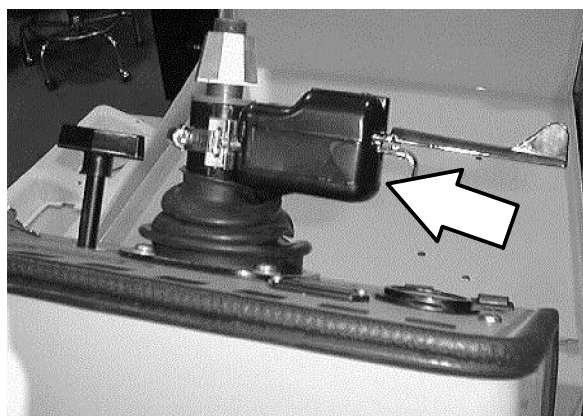
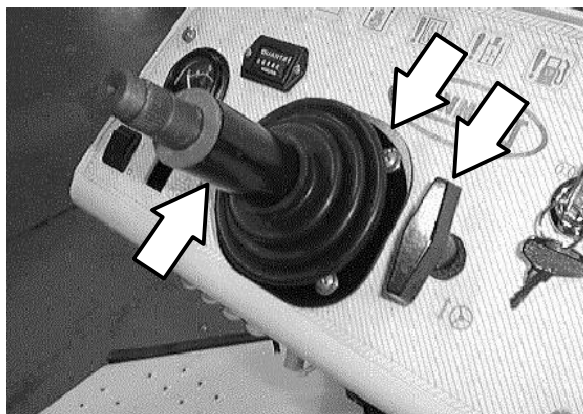
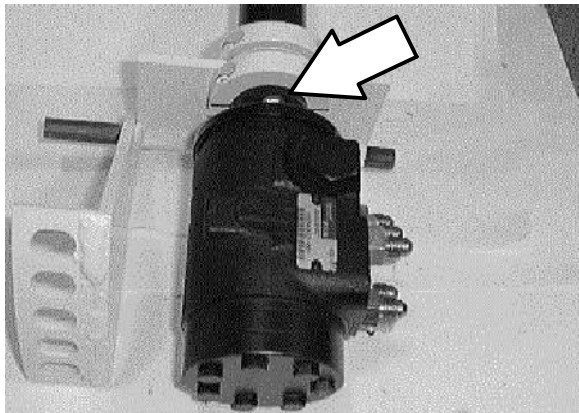
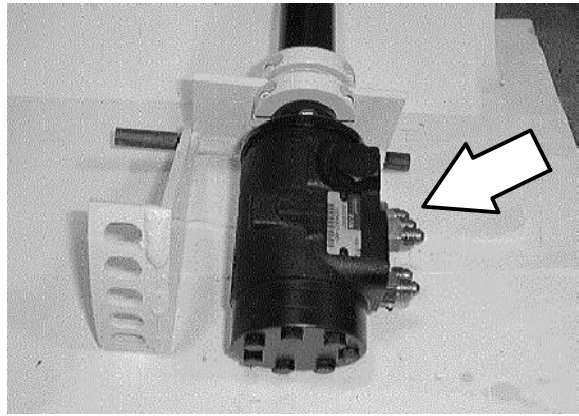

TO REPLACE DRIVE WHEEL MOTOR

FOR SAFETY: Before Leaving Or Servicing Machine; Stop On Level Surface, Set Parking Brake, turn off machine, and remove key.

1. Place blocks in front and back of the **front** tires.
2. Jack up the rear of the machine at the indicated jack points. Install jack stands under the machine frame.

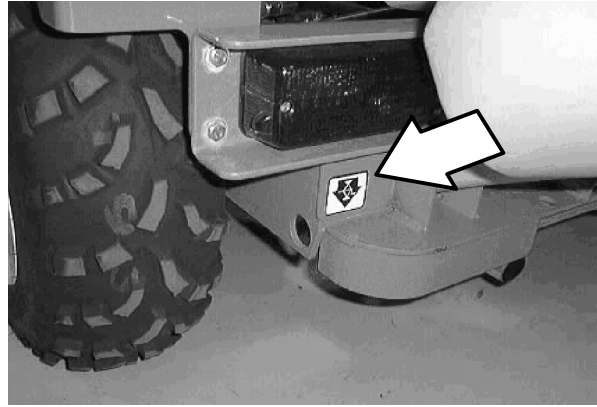

NOTE: Make sure the parking brake is engaged.

3. Remove the five wheel nuts. Remove the tire and wheel assembly from the machine.
4. Remove the castle nut from the center of the wheel hub.
5. Disengage the parking brake.
6. Remove the tension spring and clevis pin from the brake cable clevis and arm on the brake assembly.
7. Remove the two M12 hex screws and nyloc nuts holding the brake assembly to the top side of the wheel motor.
8. Pull the brake assembly straight up and off the brake hub.
9. A large wheel puller must be used to remove the wheel hub from the hydraulic drive motor. Remove the hub.

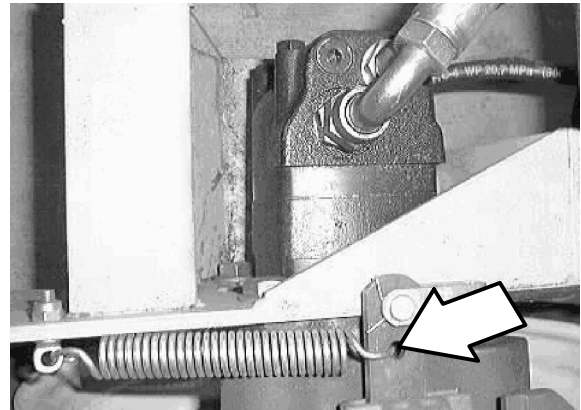

NOTE: Observe hydraulic cleanliness requirements when opening hydraulic lines.

10. Mark, disconnect, and plug the hydraulic hoses leading to the drive motor.
11. Remove the remaining two M12 hex screws and nyloc nuts holding the drive motor to the machine frame. Remove the drive motor from the machine.

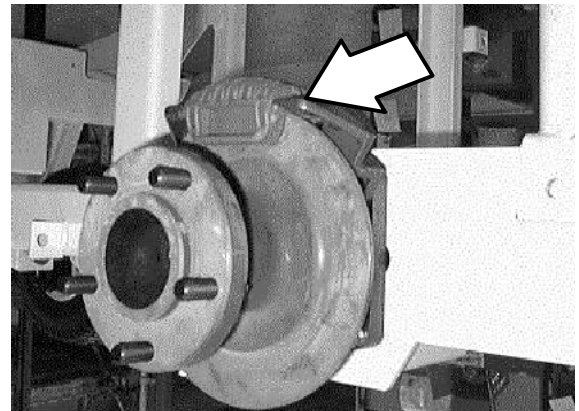

NOTE: Note that the two longer bolts go in the upper mount holes.

12. Remove the hydraulic fittings from the old drive motor and install in the new motor in the same orientation.

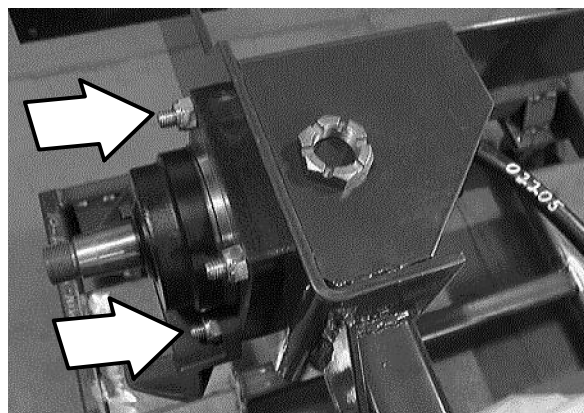

HYDRAULICS

13. Install the new motor in the machine (fittings face up). Line up the mount holes and reinstall the lower hex screws (short ones) and nuts. Leave loose for now.
14. Apply a small amount of white grease on the shaft of the new drive motor before installing the wheel hub.
15. **Use a small amount of blue loctite (242) on the threads of the motor shaft**
Install the wheel hub and castle nut. Tighten to at least 170 Nm (125 ft. lb).
16. Spread the brake pads and slide the brake assembly onto the wheel hub.
17. Align the holes in the brake assembly with the mount holes in the wheel motor.
18. Reinstall the two longer hex screws. Tighten all four hex screws to 64 - 83 Nm (47 - 61 ft. lb.).

NOTE: Make sure to install the two longer bolts into the upper holes.

19. Reconnect the hydraulic hoses to the new drive motor. See hose diagram in this section.
20. Reinstall the clevis pin in the end of the brake cable at the brake arm.
21. Reinstall the tension spring on the brake arm.
22. Engage the parking brake.
23. Reinstall the rear tire and wheel assembly.
24. Reinstall the five wheel nuts and tighten to 122 - 162 Nm (90 - 120 ft. lb).
25. Tilt the hopper forward and lower the hopper cover.
26. Remove the jack stands and lower the machine.
27. Remove the blocks from the front tires and disengage the parking brake. Operate the machine and check for proper operation.

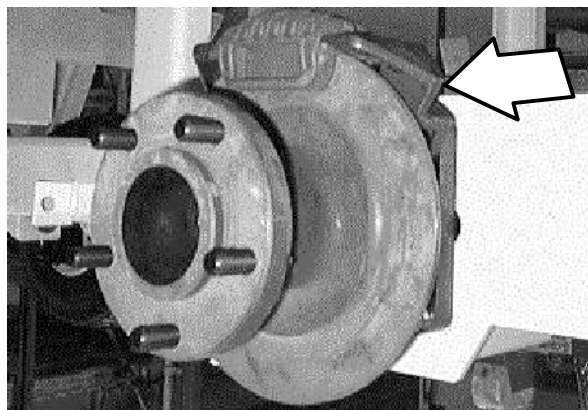
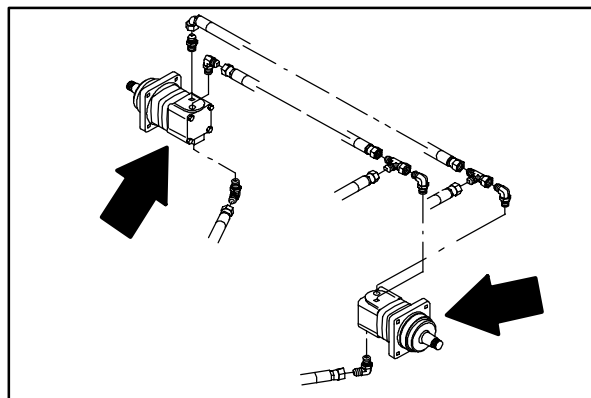
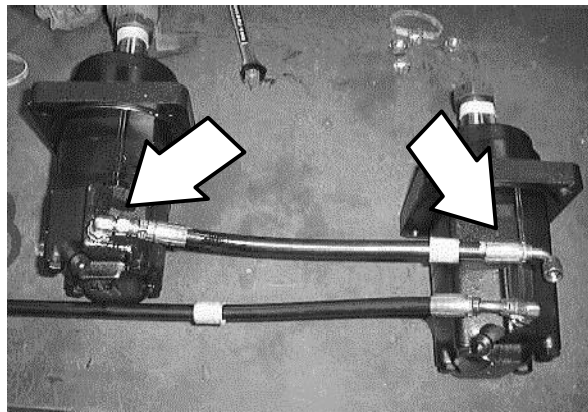

STEERING CYLINDER

The steering cylinder on the model ATLV™ 4300 is located at the front of the front axle assembly, between the front wheels. The steering cylinder is controlled by the steering wheel motor and hydraulic flow from the accessory pump.

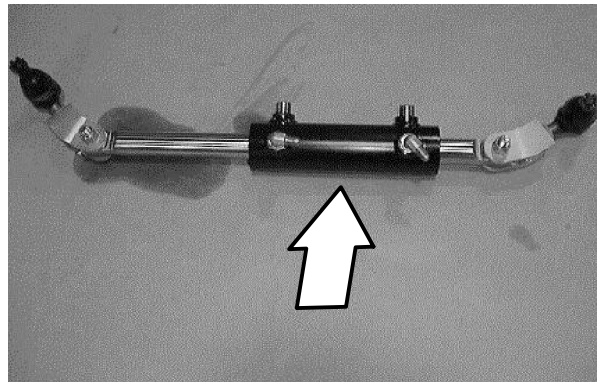

TO REPLACE STEERING CYLINDER

FOR SAFETY: Before Leaving Or Servicing Machine; Stop On Level Surface, Set Parking Brake, turn off machine, and remove key.

1. Jack up the front of the machine at the indicated jack points. Install jack stands under the machine frame.
2. Remove the .50" hex screws and nyloc nuts from the clevises and cylinder ends. Pull the clevis off the cylinder.

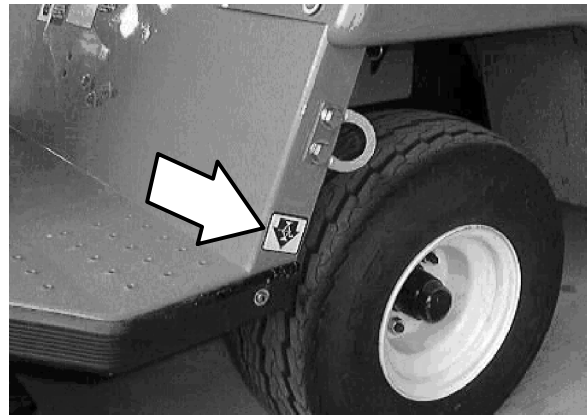

NOTE: Make sure to retain the steel spacers (2 per end) in the end of the cylinder.

3. Mark, disconnect, and plug the two hydraulic hoses leading to the steering cylinder.

NOTE: Observe hydraulic cleanliness requirements when opening hydraulic lines.

4. Remove the two M12 hex screws holding the steering cylinder to the front axle. Make sure to retain the two tube spacers and vacuum head mount plate (if equipped).
5. Remove the fittings from the old steering cylinder and install in the new cylinder in the same orientation.
6. Position the new steering cylinder onto the front of the front axle. Reinstall the two tube spacers, vacuum head mount plate (if equipped), and two hex screws. Tighten to 64 - 83 Nm (47 - 61 ft. lb.)
7. Grab the front tires and move inward until the ball end clevis mount hole lines up with the end of the new steering cylinder. Make sure the steel spacers are in place at the end of the cylinder.

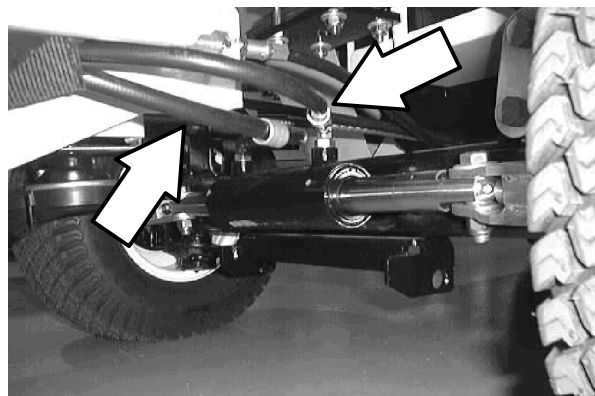
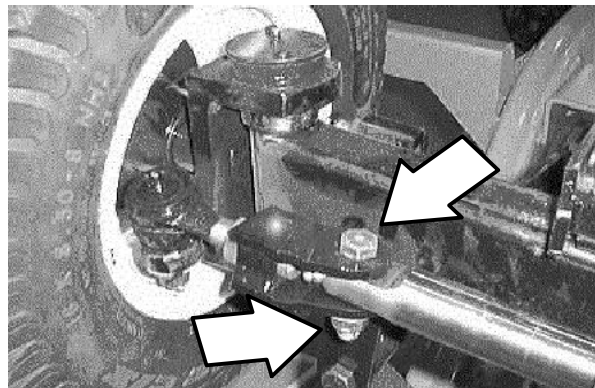

HYDRAULICS

8. Reinstall the hex screws and nuts into the clevises. Tighten to 64 - 83 Nm (47 - 61 ft. lb.)
9. Reconnect the hydraulic hoses to the new steering cylinder. See hose diagram in this section.
10. Check the front wheel alignment. See TO ALIGN FRONT TIRES instructions in this section.
11. Remove the jack stands and lower the machine to the floor.
12. Operate the machine and check the new steering cylinder for proper operation.

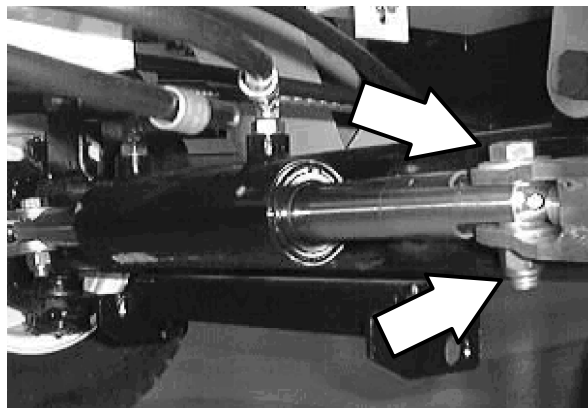
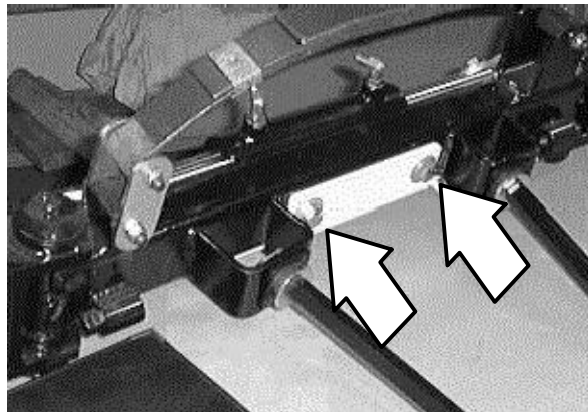

STEERING CYLINDER BREAKDOWN

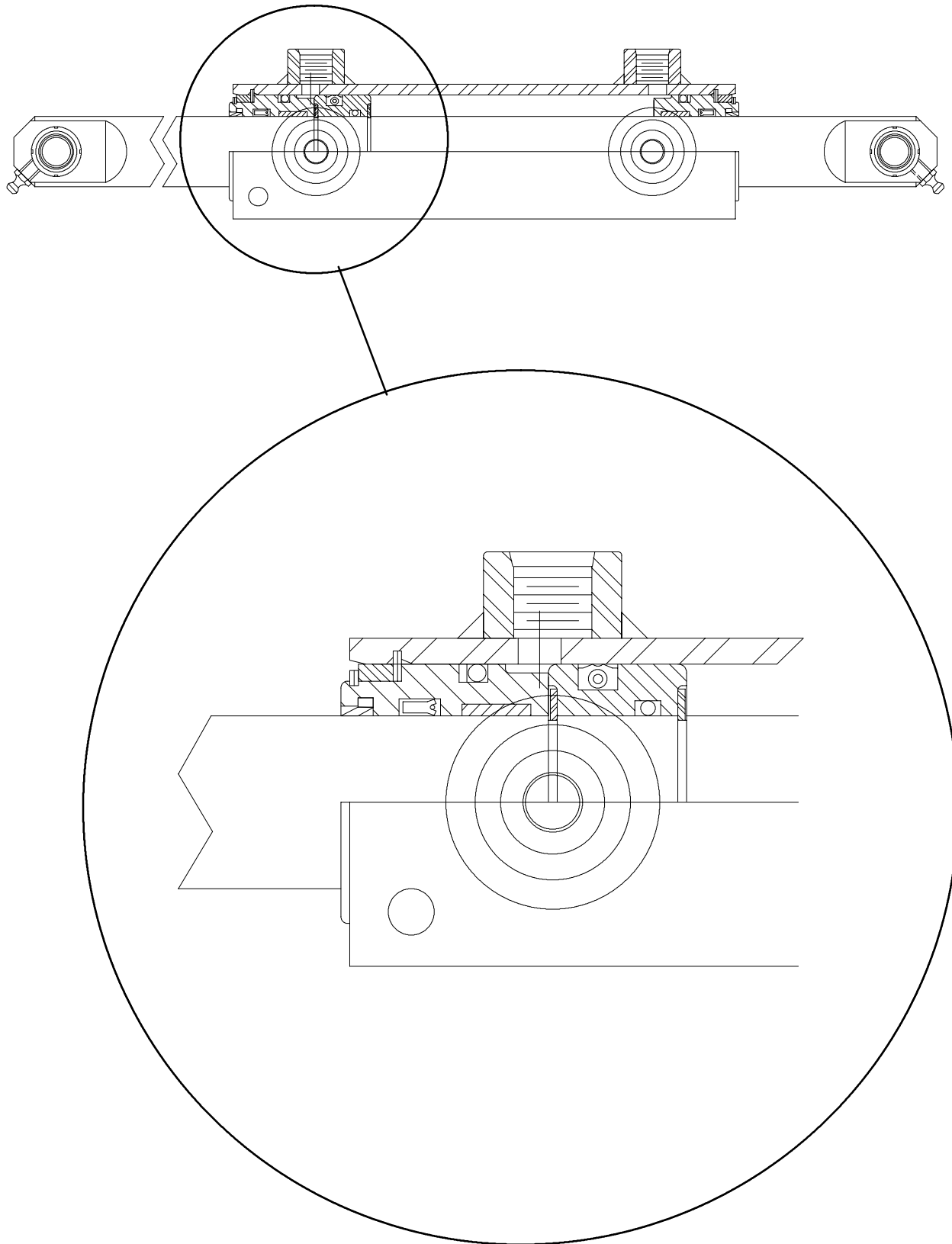

CONTROL VALVE

The solenoid control valve is located on the lower frame behind the engine, just below the bottom of the hopper. The solenoid control valve receive hydraulic flow from the accessory pump and distributes this flow to the steering and vacuum fan circuit. The vacuum fan function is controlled by a dash mounted switch.

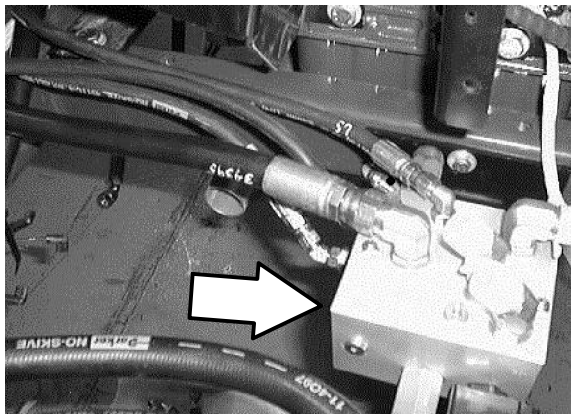

TO REPLACE SOLENOID CONTROL VALVE

FOR SAFETY: Before Leaving Or Servicing Machine; Stop On Level Surface, Set Parking Brake, turn off machine, and remove key.

1. Open the hopper cover and tilt the hopper back.
2. Remove the five pan screws holding the rear engine cover to the machine. Remove the cover.
3. Locate the solenoid control valve behind the engine, just below the rear frame member.
4. Disconnect the main harness from the electrical solenoid on the back side of the valve.
5. Mark, disconnect, and plug the hydraulic hoses leading to the control valve.

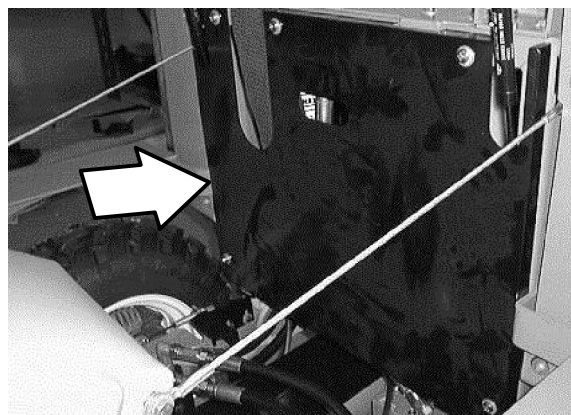

NOTE: Observe hydraulic cleanliness requirements when opening hydraulic lines.

6. Remove the two M6 hex screws and nyloc nuts holding the control valve to the mount bracket. Remove the control valve from the machine.
7. Remove the hydraulic fittings from the old control valve and install into the new valve in the same orientation.
8. Position the new valve assembly on the mount bracket. Reinstall the hardware and tighten to 8 - 10 Nm (6 - 8 ft. lb).

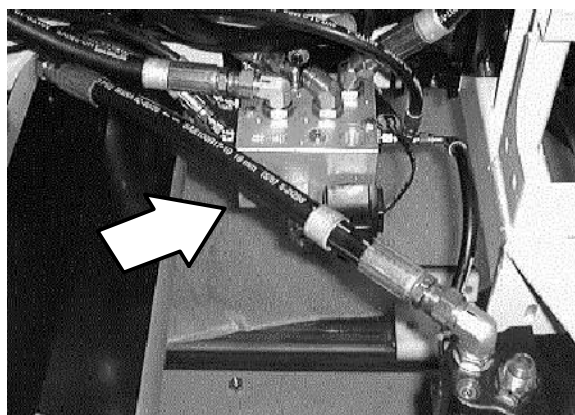
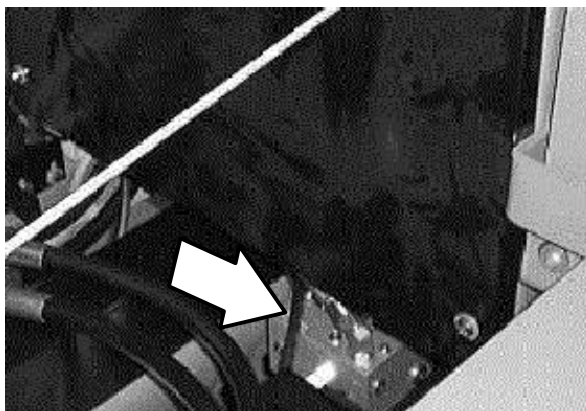

9. Reconnect the hydraulic hoses to the new valve. See hose diagram in this section.
10. Reconnect the solenoid valve to the main electrical harness.
11. Reinstall the rear engine cover.
12. Tilt the hopper forward and lower the hopper cover.
13. Operate the machine and check the new steering cylinder for proper operation.

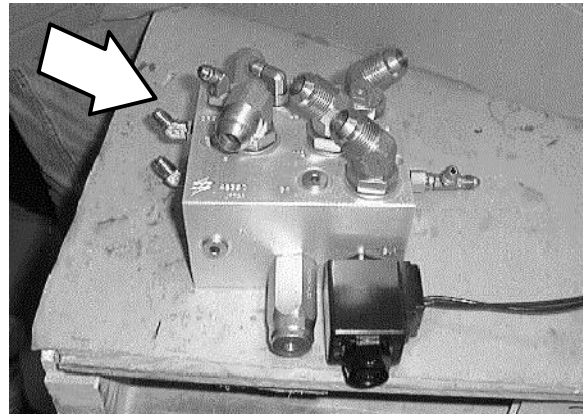

HYDRAULIC SCHEMATIC

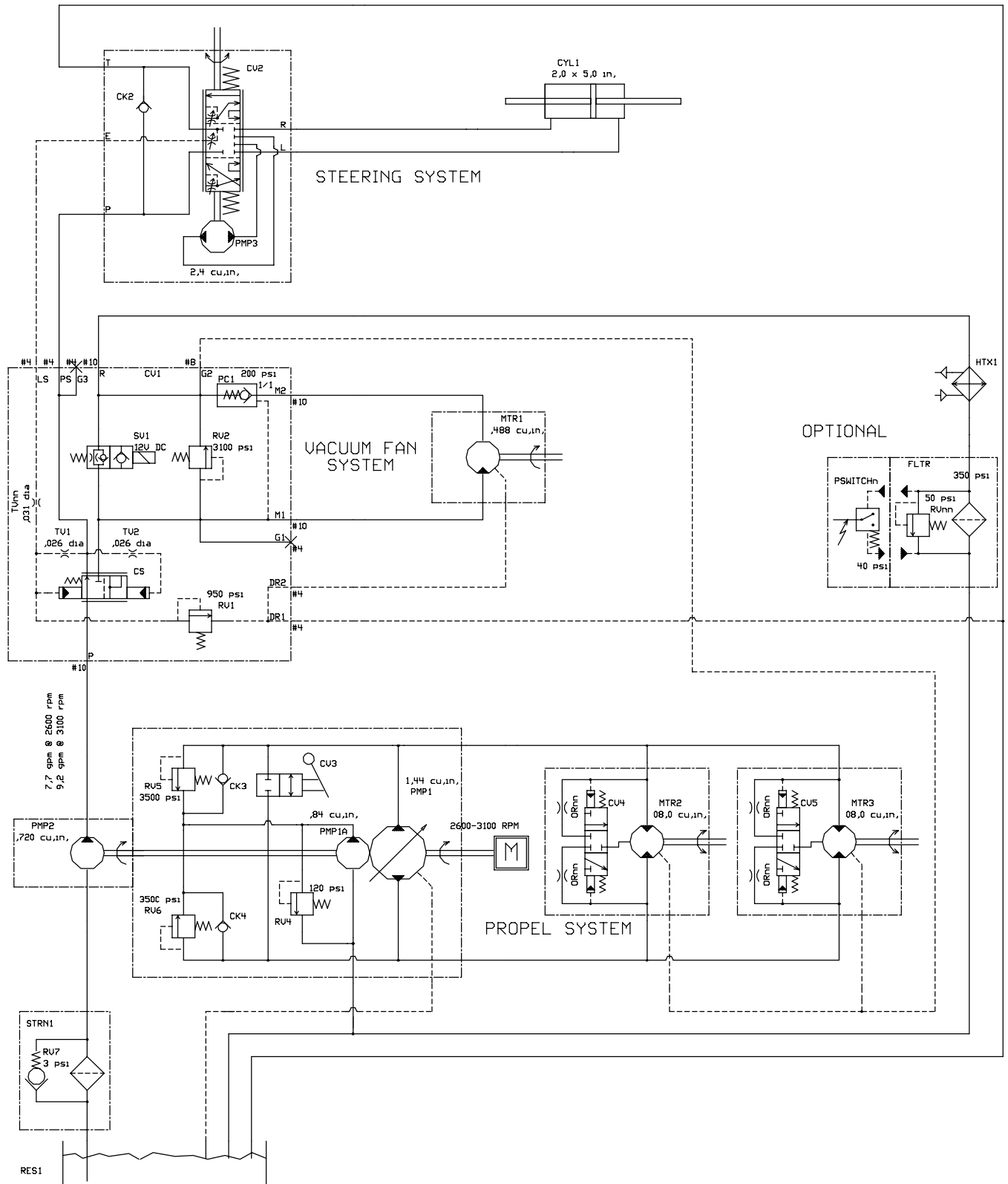

HYDRAULIC HOSE GROUP

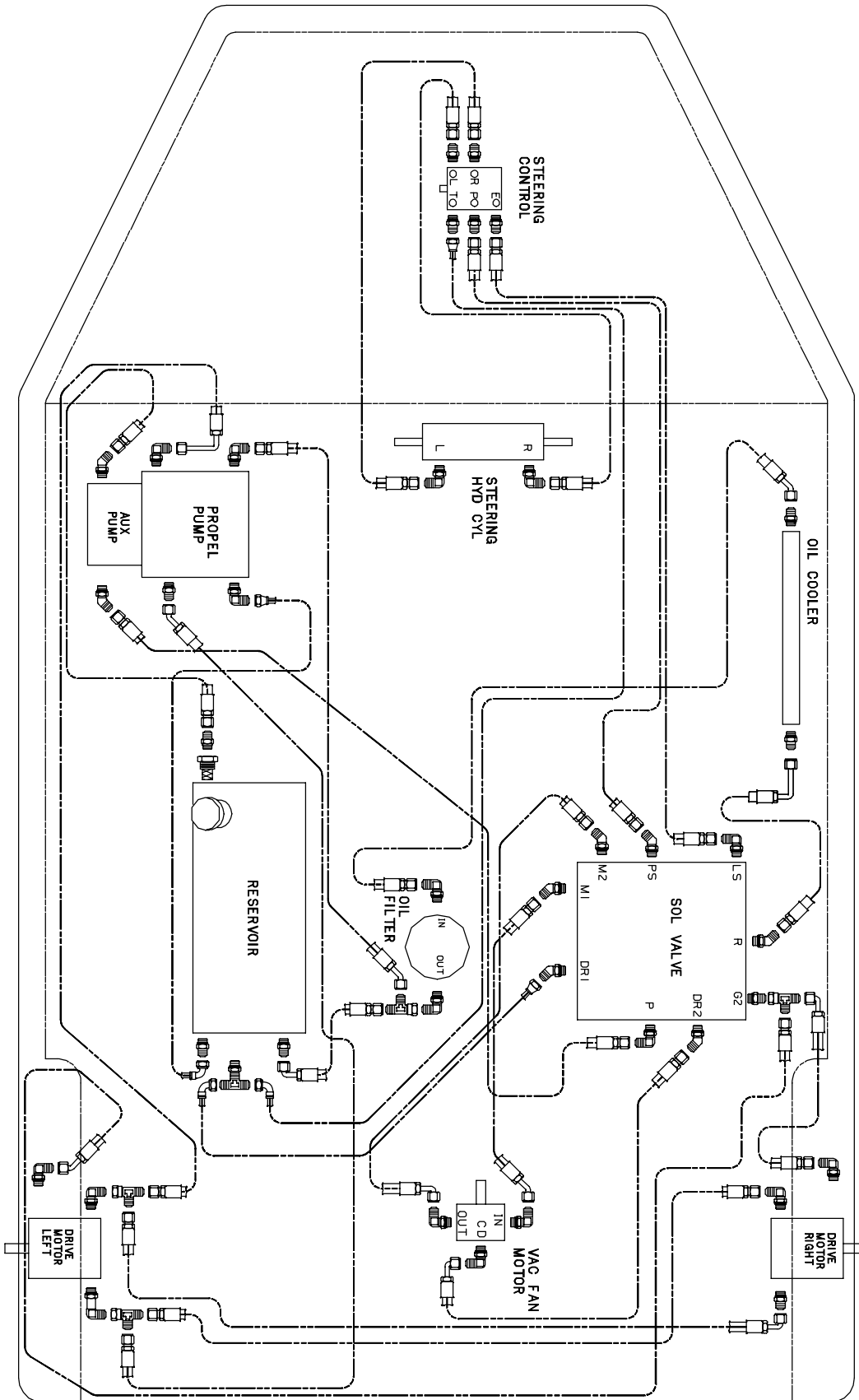

TROUBLESHOOTING

The troubleshooting charts that follow are organized to lead you through the circuits.

POWER STEERING IS NOT NORMAL

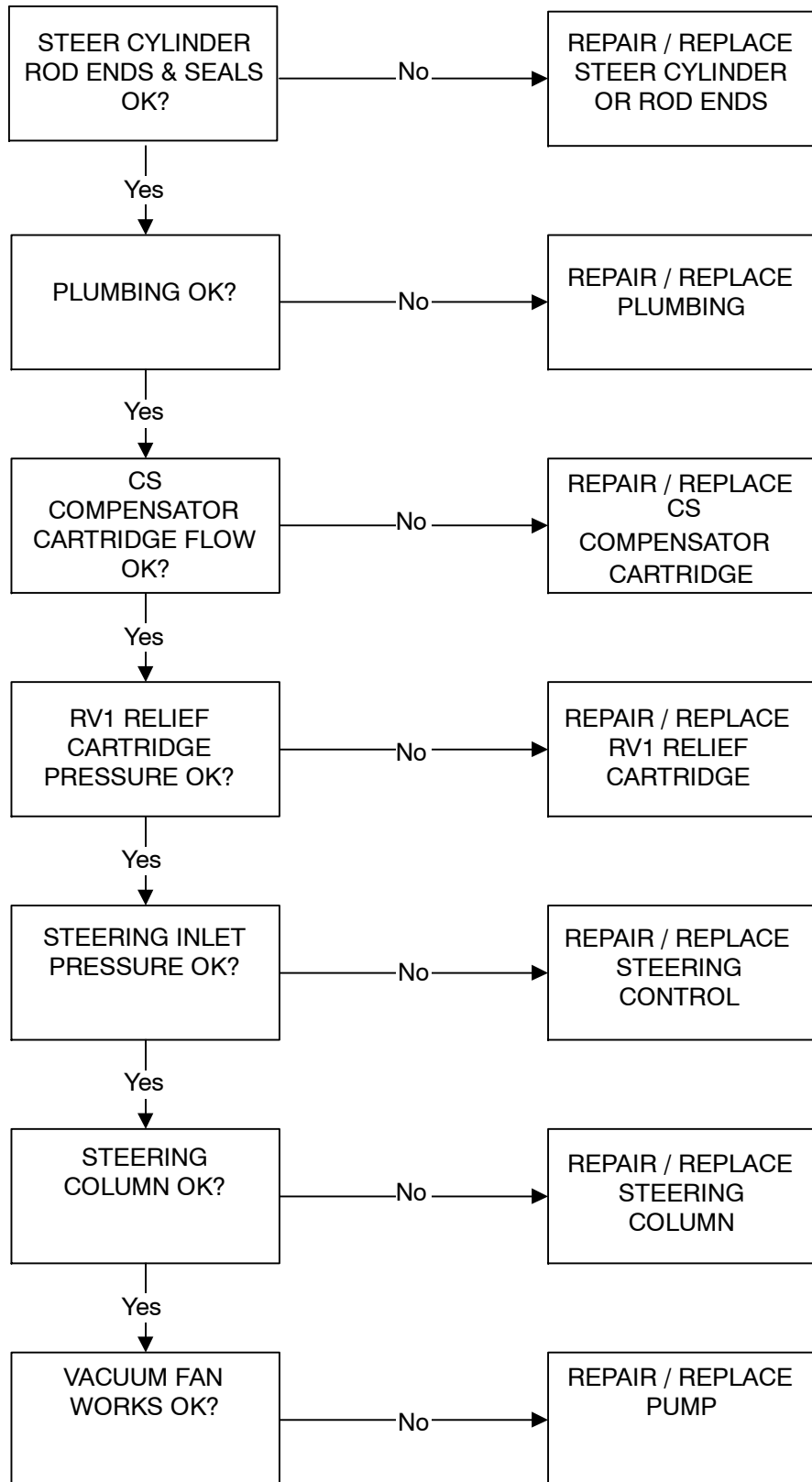

VACUUM FAN WILL NOT TURN ON

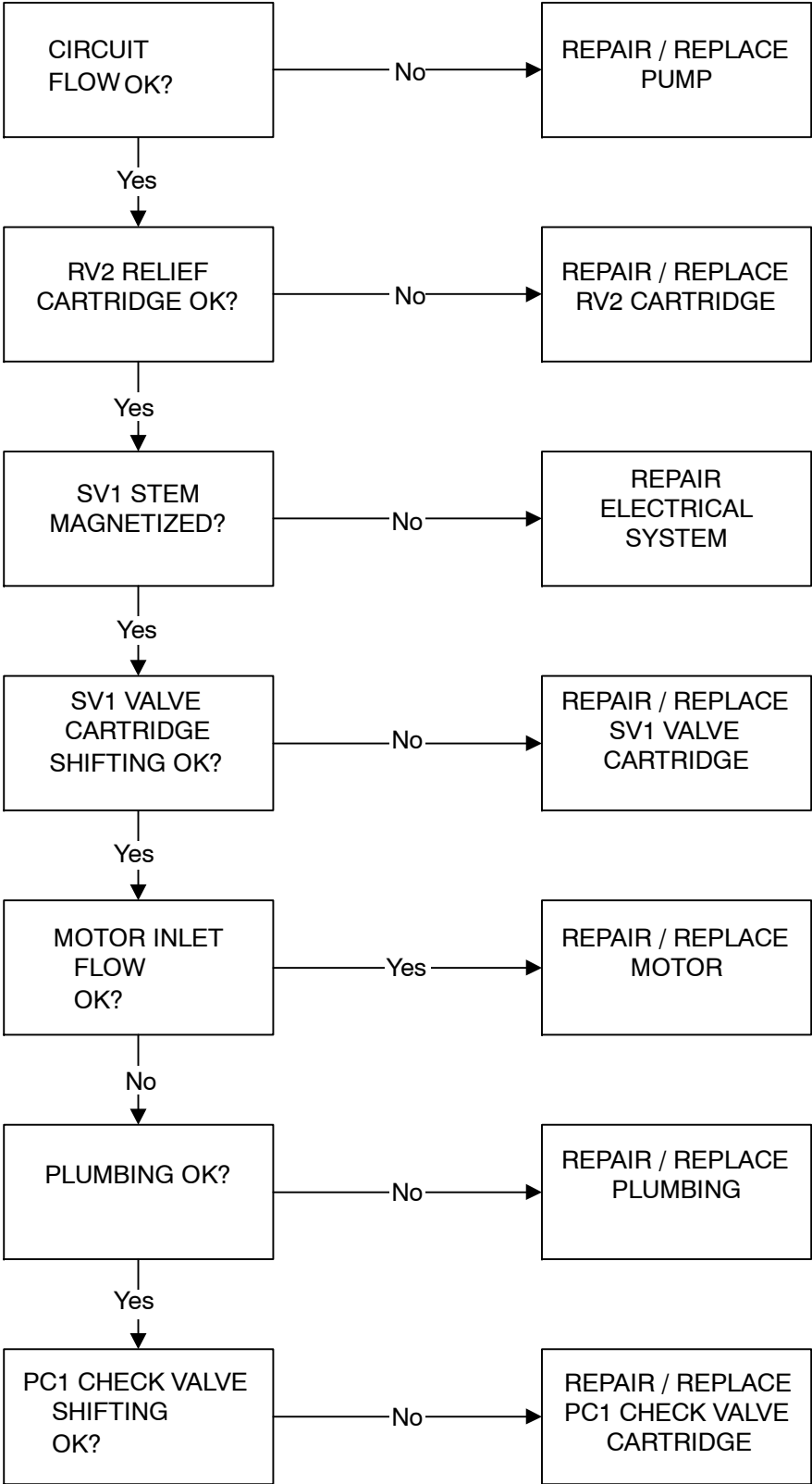

VACUUM FAN WILL NOT TURN OFF

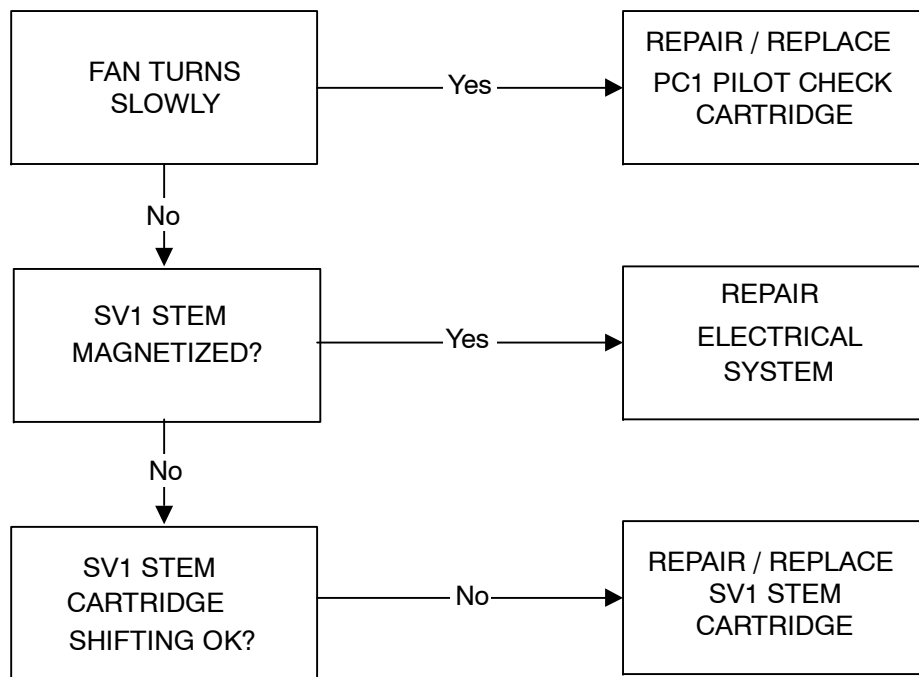

PROPEL MOTOR WILL NOT PROPEL

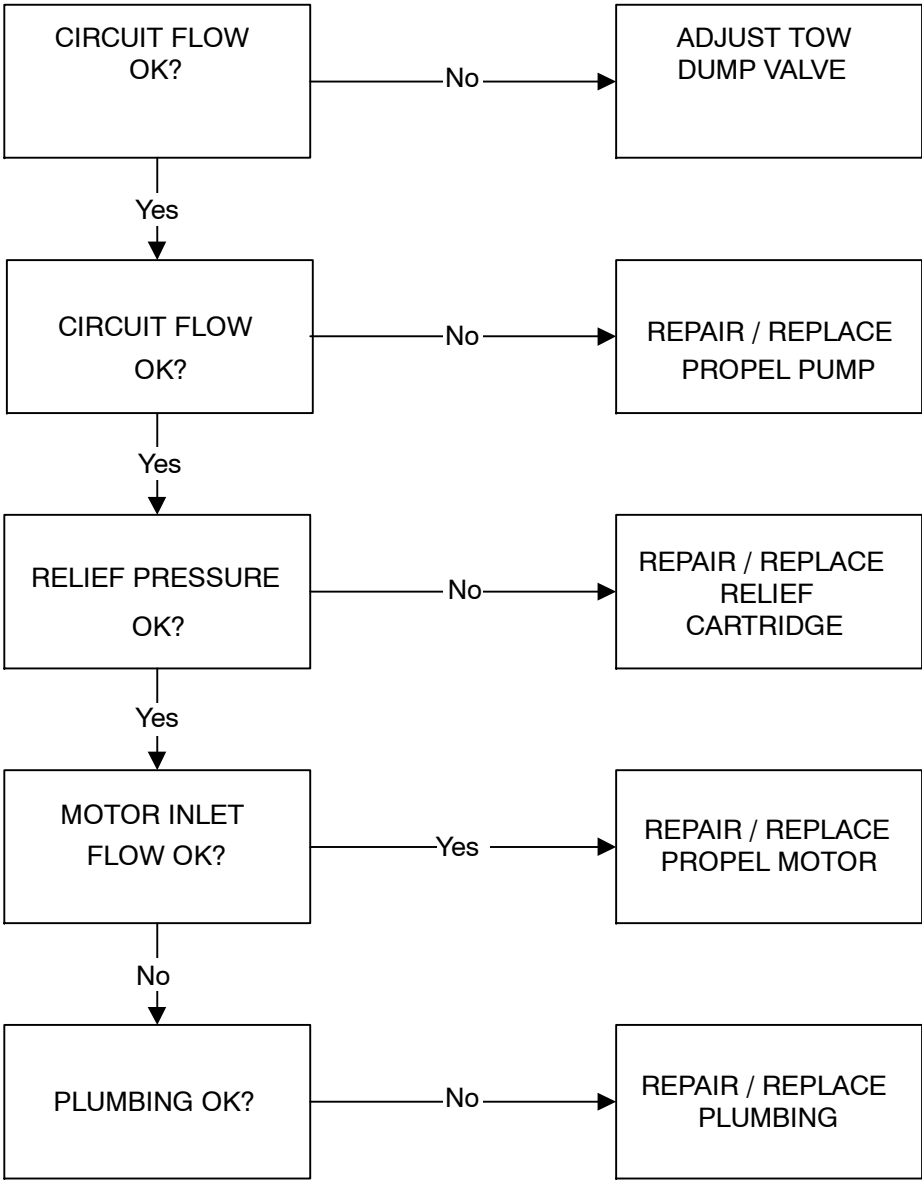

Char-Lynn®

Hydraulic Motor

No. 7-124
July, 1999



Repair Information

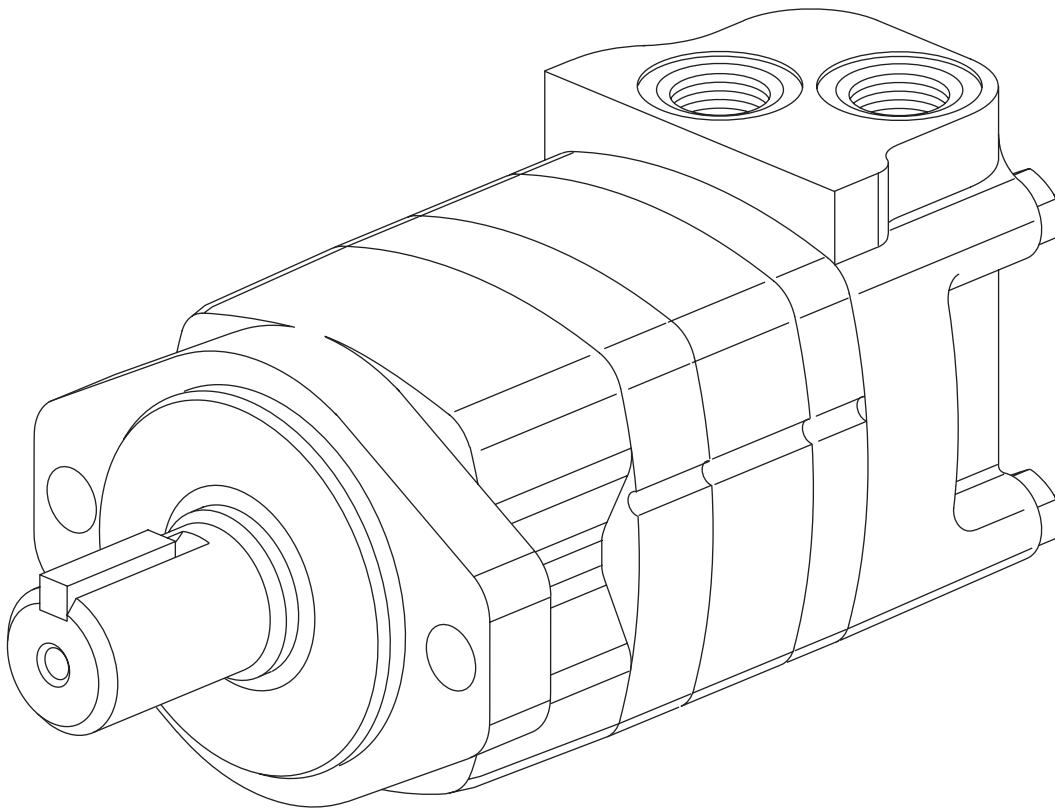

2000 Series
Disc Valve Geroler Motor

006

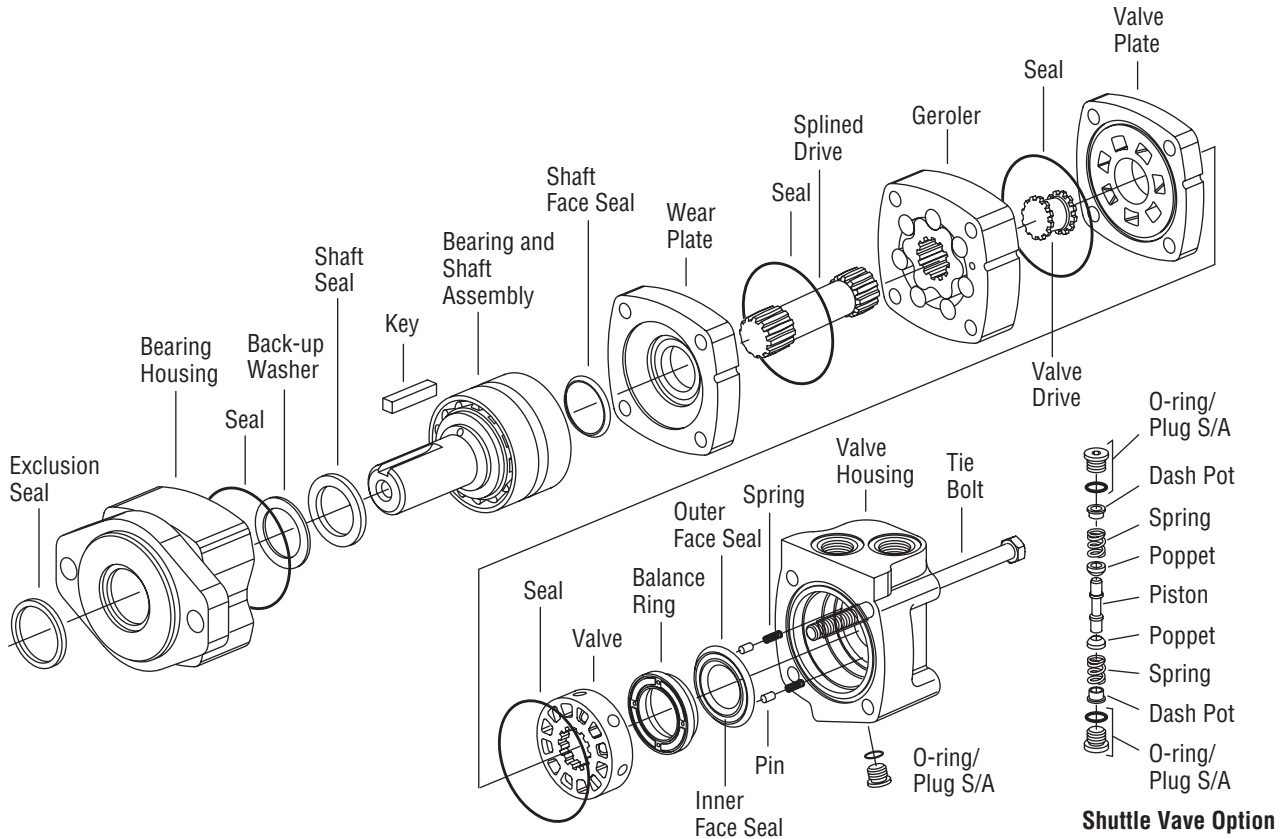

Tools required for disassembly and reassembly.

- Torque wrench 57Nm [500 lb-in] capacity
- 300-450 [12-16]* breaker bar
- 9/16 socket
- Small screwdriver 150-200 x 6,5 [6-8 x 1/4] blade
- 3/16 Allen wrench
- Press

* Unless indicated otherwise, measurements are given in mm [inches]

** Shaft seal installation tool (600496)

** Bullet (600465) for 1 diameter shafts

The following tools are not necessary for disassembly and reassembly, but are extremely helpful.

Alignment studs (2)

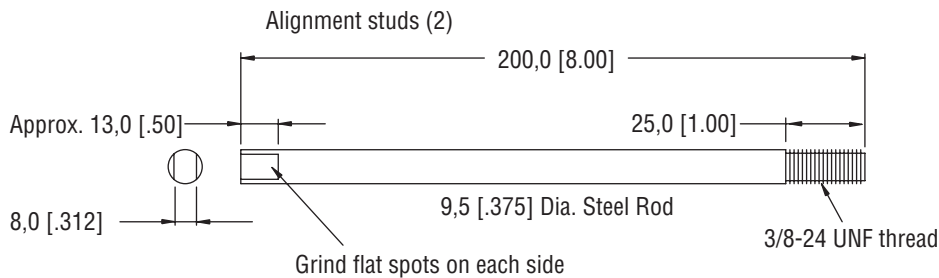

Disassembly

Cleanliness is extremely important when repairing a hydraulic motor. Work in a clean area. Before disconnecting the lines, clean the port area of the motor thoroughly. Use a wire brush to remove foreign material and debris from around the exterior joints of the motor. Check the shaft and key slot, remove all nicks, burrs or sharp edges that might damage the bearing housing seals when installing the shaft and bearing assembly. Before starting the disassembly procedures, drain the oil from inside the motor.

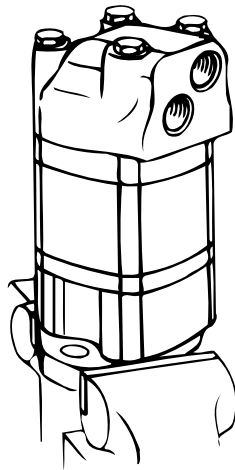

Figure 1

1 Place the motor in a vise with the output shaft down. Clamp across the mounting flange of the motor not the housing. Excessive clamping pressure will cause distortion. When clamping, use some protective device on the vise, such as special soft jaws, pieces of hard rubber or board.

Although not all drawings show the motor in a vise, we recommend that you keep the motor in the vise during disassembly and reassembly. Follow the clamping procedures explained throughout the manual.

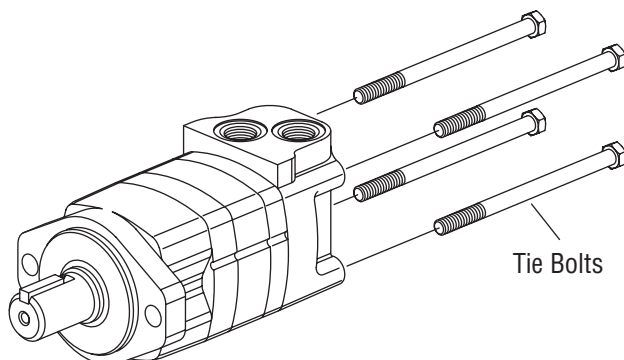

Figure 2

2 Remove 4 bolts from motor.

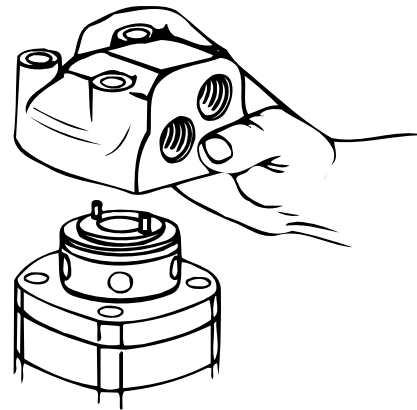

Figure 3

3 Lift valve housing straight up. If done carefully the pins, springs, balance ring assembly, and valve will remain on the valve plate.

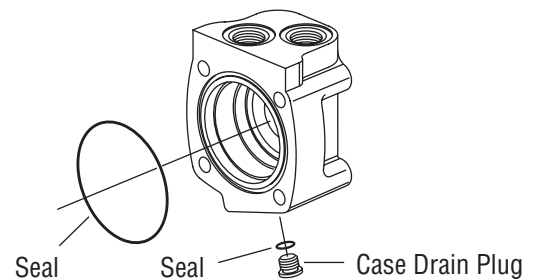

Figure 4

4 Carefully remove 76,0 [3.00] diameter seal from valve housing.

5 Remove case drain plug—with seal, from valve housing.

6 Remove 2 pins and 2 springs from balance ring assembly, see Figure 5.

Disassembly

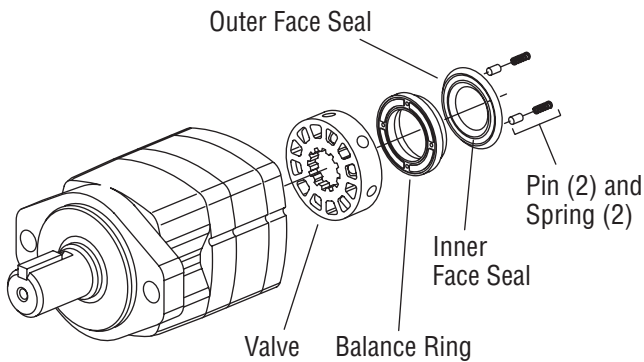

Figure 5

- 7 Remove balance ring assembly.
- 8 Remove inner and outer face seals from balance ring.
- 9 Remove the valve.

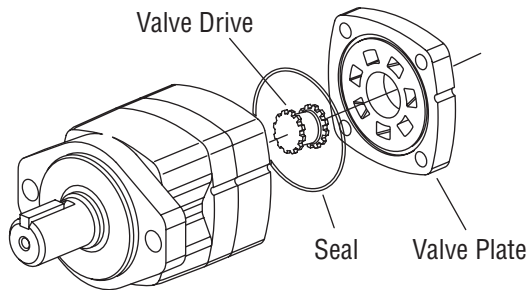

Figure 6

- 10 Remove the valve plate.
- 11 Remove the 76,0 [3.00] diameter seal from valve plate.
- 12 Remove the valve drive.

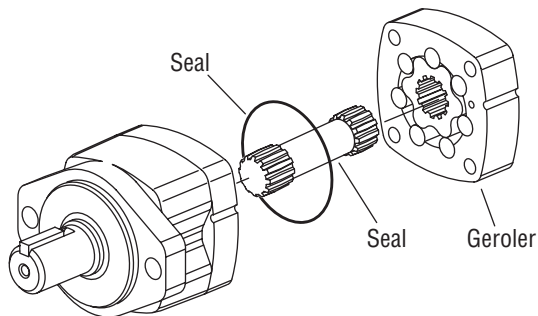

Figure 7

- 13 Remove the Geroler. Be sure to retain the rollers in the outer ring if they are loose.
- 14 Remove the drive.

- 15 Remove the 76,0 [3.00] diameter seal from wear plate, see Figure 7.

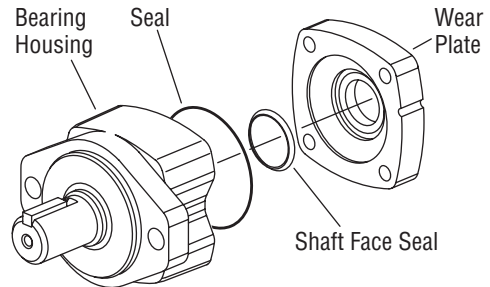

Figure 8

- 16 Remove the wear plate.
- 17 Remove the shaft face seal from the wear plate.
- 18 Remove the 76,0 [3.00] diameter seal from bearing housing.

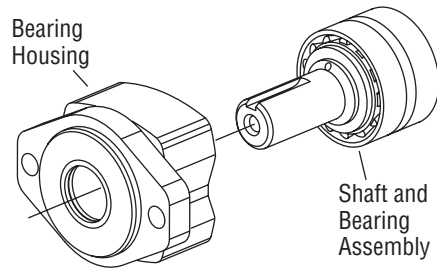

Figure 9

- 19 You may need a press to remove shaft and bearing assembly from bearing housing. (Key must be removed before removing shaft.)

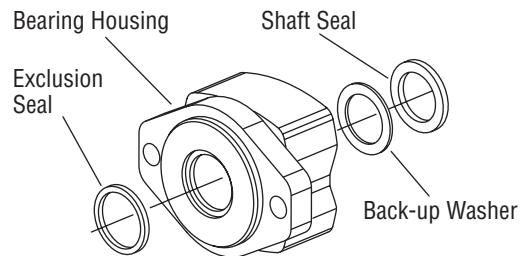

Figure 10

- 20 Use a small screwdriver to remove shaft seal, back-up washer and exclusion seal from bearing housing, see Figure 10. Do not damage bore of housing.

Note: Individual parts of shaft and bearing assembly are not sold separately. Replace as a unit.

Reassembly

Check all mating surfaces. Replace any parts that have scratches or burrs that could cause leakage. Clean all metal parts in clean solvent. Blow dry with air. Do not wipe dry with cloth or paper towel because lint or other matter can get in the hydraulic system and cause damage. Do not use a coarse grit or try to file or grind these parts. Check around the keyway and chamfered area of the shaft for burrs, nicks or sharp edges that can damage the seals when reassembling the bearing housing.

Note: Lubricate all seals (prior to installation) with petroleum jelly such as Vaseline. Use new seals when reassembling this motor. Refer to parts list (6-129) for proper seal kit number.

21 Use a press to install exclusion seal in outer bore of bearing housing. Lip of seal must face outward. See Figure 11. If a press is not available use a plastic or rubber hammer, being careful not to damage or cock seal in the bore.

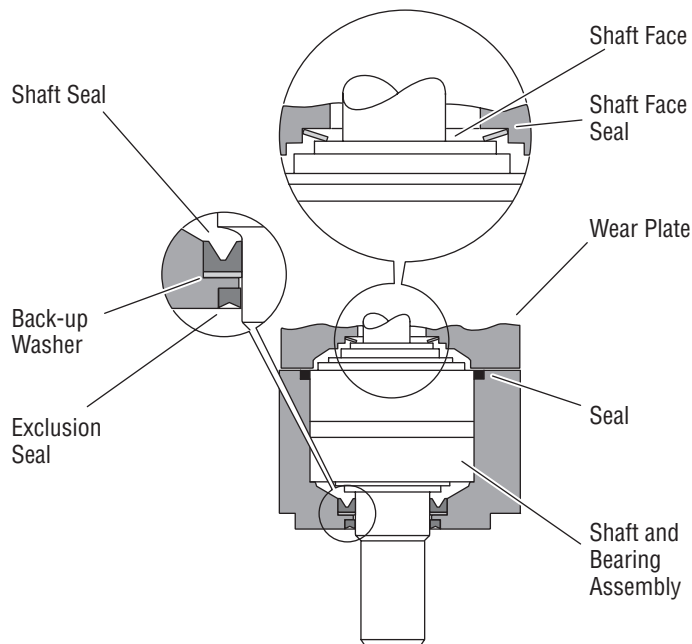

Figure 11

22 Place back-up washer into seal bore. Place shaft seal onto installation tool (600496) and press seal into seal bore of the housing.

23 Clamp housing in vise, see Figure 1.

24 Place protective bullet (see note below) over shaft. Apply petroleum jelly to inside diameter of dust and shaft seal. You may need a press to install shaft and bearing assembly. Do not distort shaft seal. Damage to this seal will cause leakage.

Note: Bullet (600465), for 1 inch dia. shafts, available— by special order. Use tape over other shafts to prevent cutting the seals.

25 Apply petroleum jelly to the 76,0 [3.00] diameter seal. Install seal into the bearing housing.

26 Alignment studs can be very helpful in reassembly of the motor. See special tool listing page 2. If you use studs, install 2 studs diagonally opposed in the bearing housing.

27 Install the shaft face seal in the wear plate as shown in Figure 11. Do not distort seal.

28 Install the wear plate, see Figure 11.

29 Apply a light film of petroleum jelly to the 76,0 [3.00] diameter seal and install seal in the wear plate.

30 Install the drive into the output shaft.

31 Align the notch on the outside of the Geroler with the notch on the wear plate. Install the Geroler against the wear plate. Be sure to retain the rollers in the outer ring if they are loose.

32 Install the valve drive in the Geroler.

Note: Installation at this time involves 3 steps in the timing of the motor. Timing determines the direction of rotation of the output shaft. Timing parts include:

1. Geroler
2. Valve Drive
3. Valve Plate
4. Valve

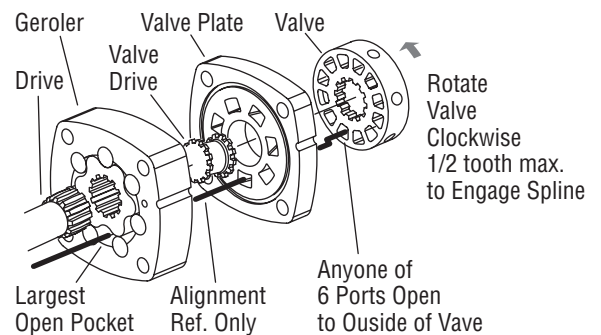

Figure 12 Timing Alignment

Timing Step # 1 — Locate the largest open pocket in the Geroler and mark it on the outside edge of the Geroler.

33 Apply a light film of petroleum jelly to the 76,0 [3.00] diameter seal. Install seal in groove of valve plate.

Reassembly

34 Align the notch on the outside of the valve plate with the notch on the Geroler as shown in Figure 12.

Timing Step # 2 — Locate the slot opening in the valve plate which is in line with the largest open pocket of the Geroler.

Timing Step # 3 — Locate any one of the side openings of the valve and align this opening with the open slot of the valve plate that is in line with the largest open pocket of the Geroler. Install the valve by rotating it clockwise until the spine teeth engage (1/2 spine tooth max.). This will provide the proper rotation when pressurized as shown in Figure 13.

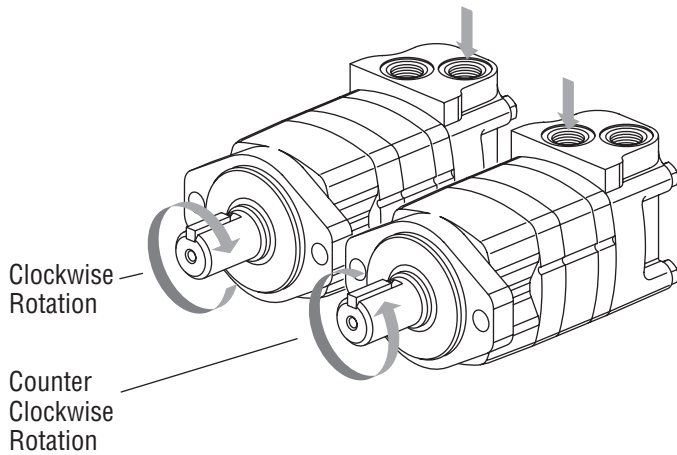

Figure 13

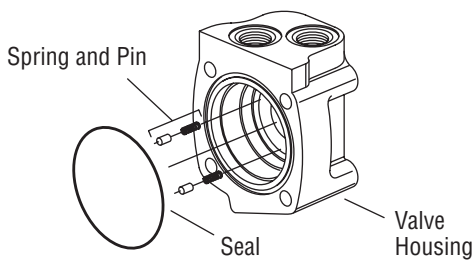

Figure 14

35 Install 2 springs and 2 pins in the holes located in the bore of the valve housing, as shown in Figure 14.

36 Apply a light film of petroleum jelly to the 76,0 [3.00] diameter seal. Install seal in the valve housing.

37 Apply petroleum jelly to inner and outer face seals. Install seals on balance ring as shown in Figure 15.

Important: Install face seals in the positions shown in Figure 15, or the motor will not operate properly. Do not force or bend the face seals. Any damage to these seals will affect the operation of the motor.

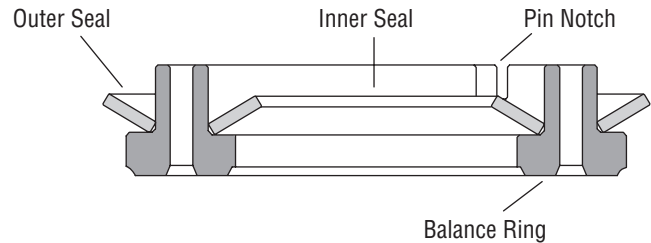

Figure 15

38 Align pin notches in balance ring with pins in bore of valve housing. Install balance ring assembly in valve housing.

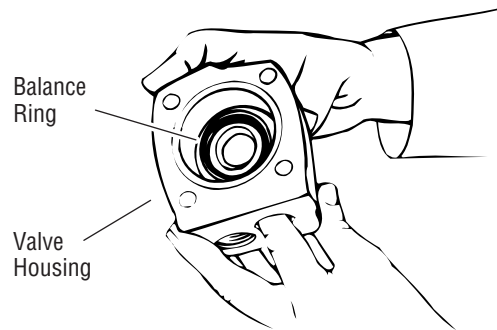

Figure 16

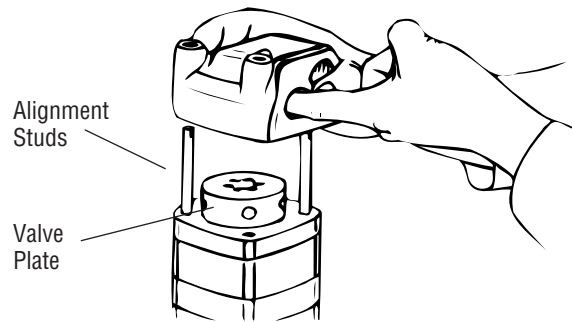

Figure 17

39 Insert your finger through port of valve housing. Apply pressure to side of balance ring as shown in Figure 16. Hold ring in position until valve housing is in place against valve plate (see Figure 17).

Note: After installing the valve housing on the valve plate check for proper placement. Push down on the valve housing. You should get a slight spring action.

Reassembly

40 Install tie bolts. If you use alignment Studs, install 2 bolts opposite the studs. Finger tighten the bolts. Remove the alignment studs and replace with the two remaining bolts. Torque all four bolts alternately to 50 Nm [450 lb-in].

41 Install seal on case drain plug then install in valve housing. Torque to 6 Nm [50 lb-in.]

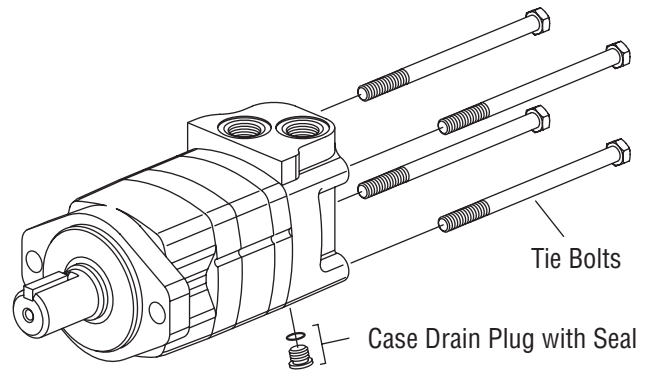

Figure 18

Wheel Motor

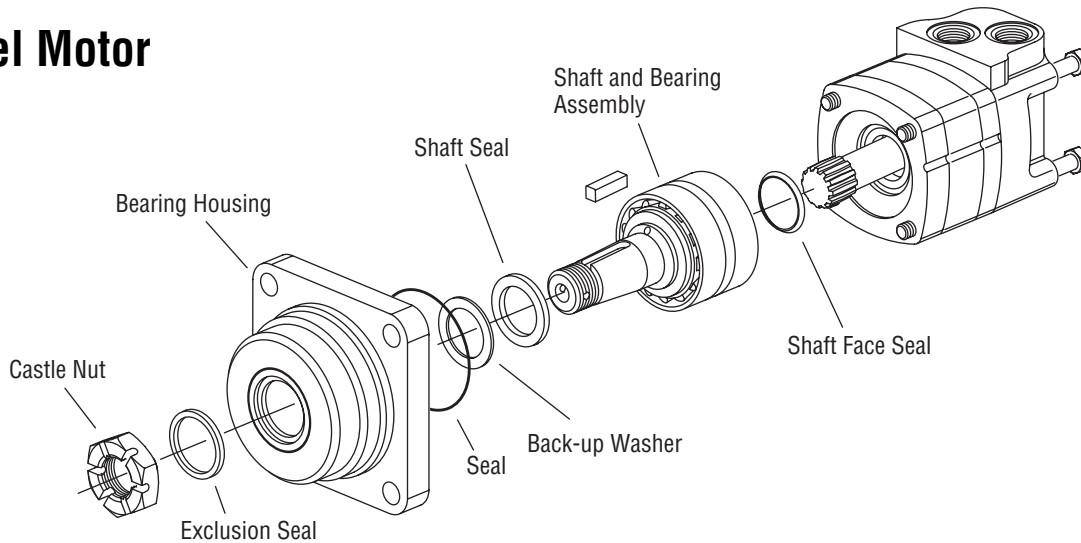

Figure 19

On wheel motors, a different bearing housing is used, see Figure 19. Other than this the parts are the same as the standard motor and the same disassembly and reassembly procedures apply.

Wheel Motor with Seal Guard

Installation of Seal Guard:

After completing assembly of the shaft and bearing assembly into the bearing housing, press the seal guard onto the shaft with a tool that will provide an even push over the seal. This tool must bottom out against the bearing housing and provide a 4,5 mm [.177 inch] stop for the seal guard.

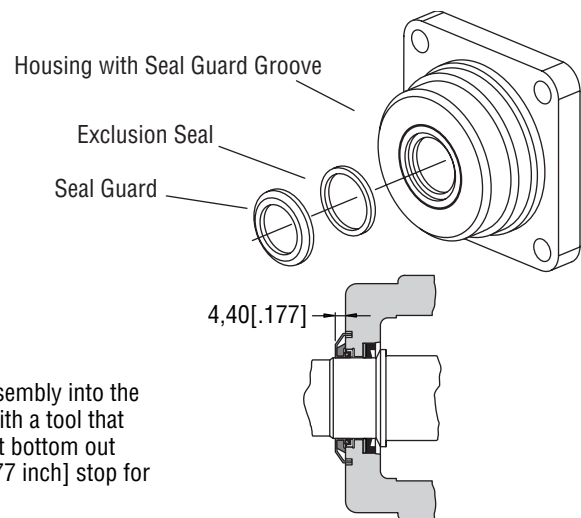

Bearingless Motor

This motor is the same as the standard motor without the shaft/bearing assembly, and bearing housing. The mounting flange replaces the bearing housing, see Figure 20. Follow same disassembly and reassembly procedures as rear section of standard motor.

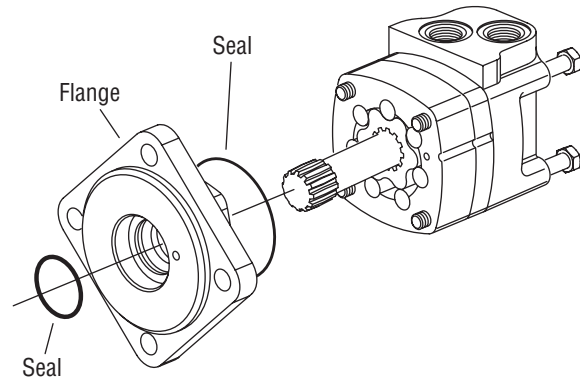

Figure 20

Disassembly Reassembly Shuttle Valve Option

Disassembly of shuttle valve option, this valve is located in the valve housing. Clean and inspect shuttle valve parts and reassemble with new seals, torque plugs to 8-11 Nm [75-100 lb-in].

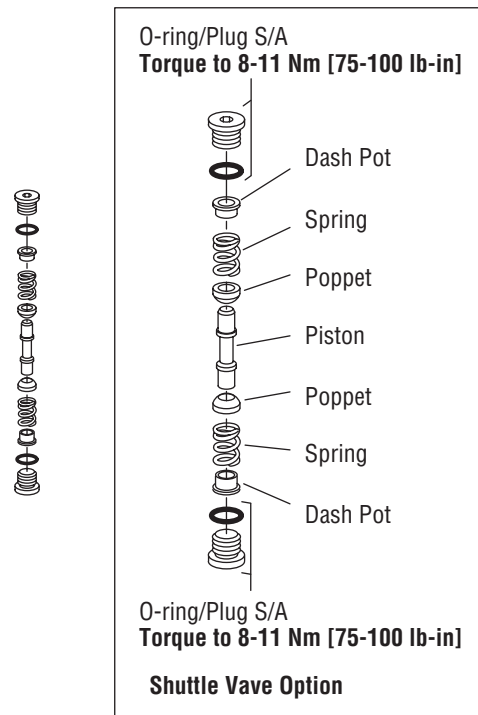
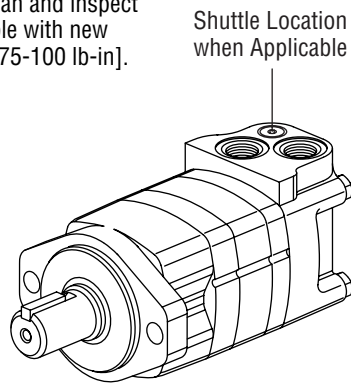

Figure 21

Reassembly — Speed Sensor

1 Rotate the motor shaft until a (gear/target) tooth is centered in the speed sensor port. If this is not done, the sensor may be damaged during the operation of the motor.

2 Make sure the lock nut and its threads are clean and dry for the proper torque. Position the lock nut against the alignment nut as shown in Figure 22.

3 Move the washer and the o-ring up against the speed sensor body threads as shown in Figure 22.

4 By hand, lightly thread the speed sensor body into the housing until the sensor touches against the motor (gear/target) tooth. **Do not force the sensor against the (gear/target) tooth, damage may occur.** Make sure the o-ring or the washer do not touch the housing — see Figure 23.

5 Turn the speed sensor body out one quarter turn (CCW) plus the additional amount (CCW) needed to make the alignment notches perpendicular to the motor shaft centerline (90° +/-5 degrees from the motor shaft centerline — Figure 24 and 25).

6 Maintain the speed sensor body alignment (Figure 25), and tighten the lock nut to 8.5-14 Nm [75-125 lb-in.] (torque values are for clean dry threads).

7 Check the speed sensor body for correct alignment (Figure 25), reinstall the sensor if it is not correct.

Speed Sensor Installation

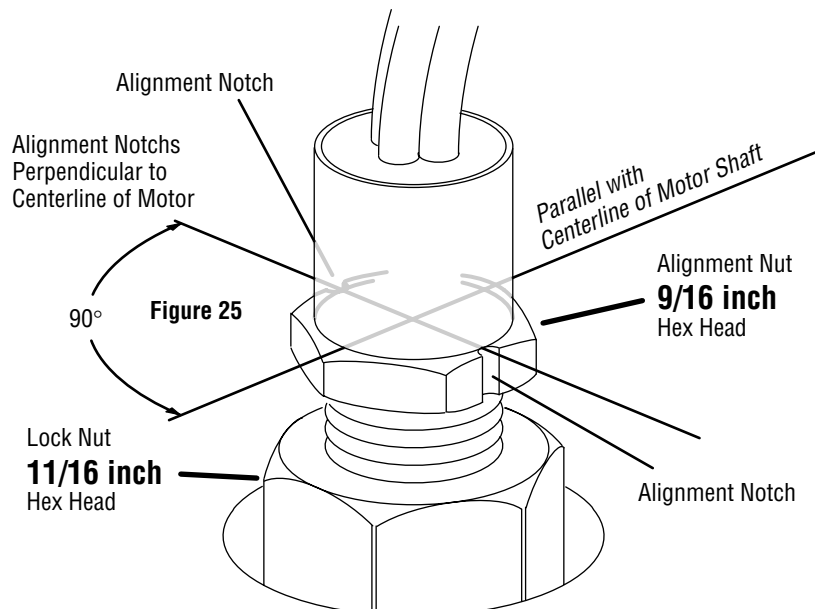
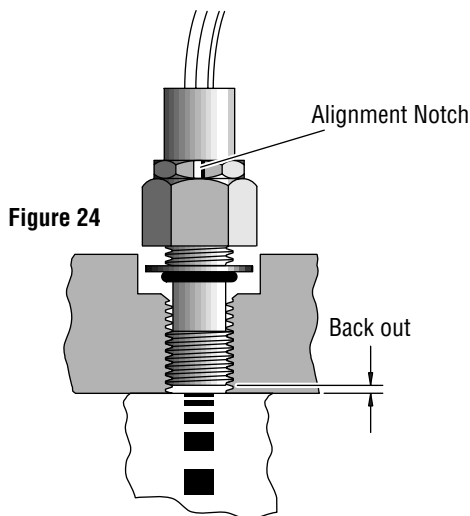
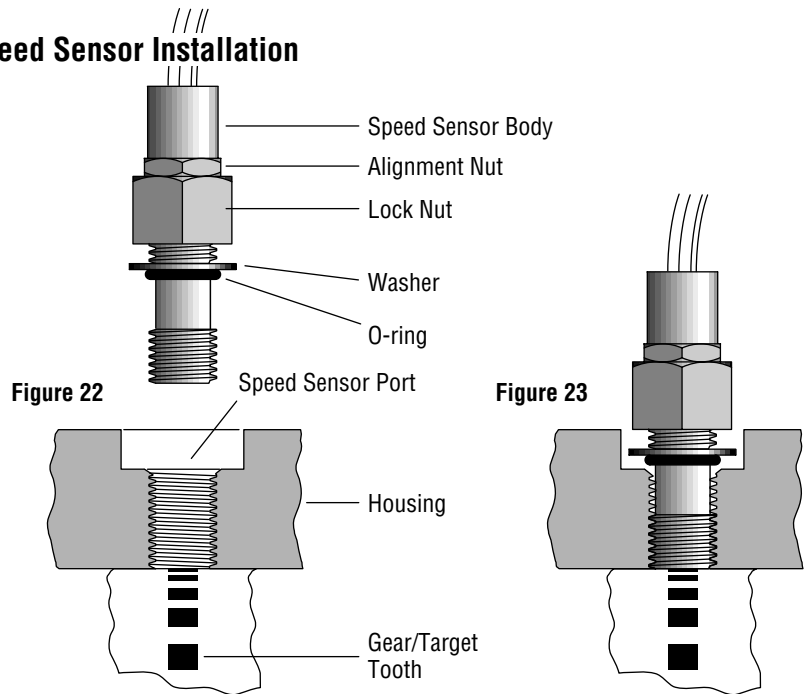

Product Identification

For Additional Literature Contact Eaton Corp. Hydraulics Division 15151 Highway 5 Eden Prairie, MN 55344.

- Specifications and performance data, Catalog No. 11-878
- Replacement part numbers and kit information — Parts Information No. 6-129

How to Order Replacement Parts

Each Order Must Include the Following:

1. Product Number
2. Date Code
3. Part Name
4. Part Number
5. Quantity of Parts

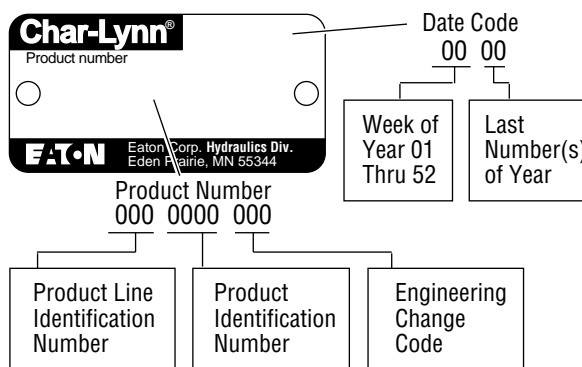

Product Numbers—2000 Series

Use digit prefix —104-, 105-, or 106- plus four digit number from charts for complete product number—Example 106-1039.

104-1007

Mounting	Shaft	Ports	Displacement cm ³ /r [in ³ /r] and Product Number								
			80 [4.9]	100 [6.2]	130 [8.0]	160 [9.6]	195 [11.9]	245 [14.9]	305 [18.7]	395 [24.0]	490 [29.8]
2 Bolt SAE A Flange	1 inch Straight	7/8-14 O-ring Staggered	104-1001	-1002	-1003	-1004	-1005	-1006	-1007	-1143	—
		1-1/16—12 O-ring 180° Apart	104-1037	-1038	-1039	-1040	-1041	-1042	-1043	-1044	—
	1-1/4 Inch Straight	7/8-14 O-ring Staggered	104-1022	-1023	-1024	-1025	-1026	-1027	-1028	-1228	-1420
		1-1/16—12 O-ring 180° Apart	104-1061	-1062	-1063	-1064	-1065	-1066	-1067	-1068	-1421
1-1/4 Inch 14 T Splined	7/8-14 O-ring Staggered	104-1029	-1030	-1031	-1032	-1033	-1034	-1035	-1229	-1422	
	1-1/16—12 O-ring 180° Apart	104-1087	-1088	-1089	-1090	-1091	-1092	-1093	-1094	-1423	
2 Bolt SAE B Flange	1-1/4 Inch Straight	7/8-14 O-ring Staggered	104-1200	-1201	-1202	-1203	-1204	-1205	-1206	-1207	—
	1-1/4 In. Involute SAE C Splined	7/8-14 O-ring Staggered	104-1208	-1209	-1210	-1211	-1212	-1213	-1214	-1215	—
	1 Inch SAE 6B Splined	7/8-14 O-ring Staggered	104-1193	-1194	-1195	-1196	-1197	-1198	-1199	—	—
	7/8 Inch SAE B Splined	7/8-14 O-ring Staggered	104-1216	-1217	-1218	-1219	-1220	—	—	—	—
Standard with 4 Bolt Square Flange	32 mm Straight	G 1/2 (BSP)	104-1384	-1385	-1386	-1387	-1388	-1389	-1390	-1391	—
	1-1/4 Inch 14 T Splined	G 1/2 (BSP)	104-1376	-1377	-1378	-1379	-1380	-1381	-1382	-1383	—
Wheel Motor	1-1/4 Inch Straight	7/8-14 O-ring Staggered	105- —	—	—	—	—	—	—	—	-1148
		1-1/16—12 O-ring 180° Apart	105- —	—	—	—	—	—	—	—	-1149
	32 mm Straight	G 1/2 (BSP)	105-1134	-1135	-1136	-1137	-1138	-1139	-1140	-1141	—
		7/8-14 O-ring Staggered	105-1001	-1002	-1003	-1004	-1005	-1006	-1007	-1060	-1152
	1-1/4 Inch Tapered	1-1/16—12 O-ring 180° Apart	105-1071	-1072	-1073	-1074	-1075	-1076	-1077	-1078	—
		7/8-14 O-ring Staggered	105-1029	-1030	-1031	-1032	-1033	-1034	-1035	-1096	—
1-1/4 Inch 14 T Splined	1-1/16—12 O-ring 180° Apart	105-1079	-1080	-1081	-1082	-1083	-1084	-1085	-1086	—	
	7/8-14 O-ring Staggered	106-1008	-1009	-1010	-1011	-1012	-1013	-1014	-1015	-1047	
Bearingless		G 1/2 (BSP)	106-1038	-1039	-1040	-1041	-1042	-1043	-1044	-1045	—

Notes: _____

Eaton Corporation
Hydraulics Division
15151 Hwy. 5
Eden Prairie, MN 55344
Telephone: 612/937-7254
Fax: 612/937-7130

Sumitomo Eaton
Hydraulic Company Ltd.
Ooi-Cho Kameoka-Shi
621-0017 Kyoto
Japan
Telephone: [+81] 771-22-9601
Fax: [+81] 771-29-2020

Eaton Ltd.
Hydraulics Division
Glenrothes, Fife
Scotland, KY7 4NW
Telephone: [+44] (0)1592-771-771
Fax: [+44] (0)1592-773-184

Eaton Ltd.
7th Floor, Woo Duk Building
832-2 Yeoksam-Dong, Kangnam-Ku
Soeul 135-750
Korea
Telephone: [+82] 2-557-0595
Fax: [+82] 2-557-1634

Eaton B.V.
Boeing Avenue 11
1119 PC Schiphol-Rijk
The Netherlands
Telephone: [+31] (0)20-655 6776
Fax: [+31] (0)20-655 6800

Eaton Hydraulics (Shanghai) Co. Ltd.
388 Aidu Road, Waigaogiao FTZ
Pudong New Area
Shanghai 200137
Peoples Republic of China
Telephone: [+86] 21-5046 0758
Fax: [+86] 21-5046 0767

Sumitomo Eaton Hydraulic Co.
8 Temasek Blvd.
42-01 Suntec Tower Three
Singapore 03988
Telephone: [+65] 832-7727
Fax: [+65] 832-7733

Jining Eaton Hydraulic Co. Ltd.
6 Ji Da Road
Jining City
Shandong Province 272131
Peoples Republic of China
Telephone: [+86] 537-2221288
Fax: [+86] 537-2221557



Quality System Certified
Products in this catalog are manufactured
in an ISO-9001-certified site.



Repair Information

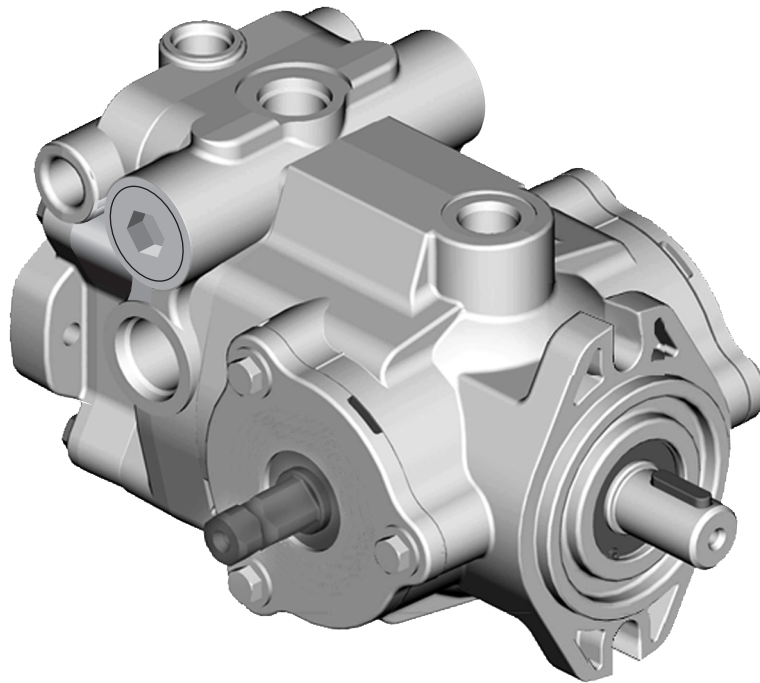

Model 70160 Variable Displacement Piston Pump

20,3 cm³/r [1.24 in³/r] or 23,6 cm³/r [1.44 in³/r] Displacements

Manual Controlled

Introduction

Table of Contents

Introduction	2
Identification	3
Tools Required	3
Parts Drawing	4 - 5
Parts List	6 - 7
Repair information	
Disassembly	8 - 10
Reassembly	11 - 12
Fault - Logic Troubleshooting	13 - 17
Start-up Procedure	18

Introduction

This manual provides service information for Eaton Models 70160 variable displacement piston pumps. Step by step instructions for the complete disassembly, inspection, and reassembly of the pump are given. The following recommendations should be followed to insure successful repairs.

- Remove the pump from the application.
- Cleanliness is extremely important.
- Clean the port areas thoroughly before disconnecting the hydraulic lines.
- Plug the pump ports and cover the open hydraulic lines immediately after they're disconnected.
- Drain the oil and clean the exterior of the pump before making repairs.
- Wash all metal parts in clean solvent.
- Use compressed air to dry the parts. Do not wipe them dry with paper towels or cloth.
- Compressed air should be filtered and moisture free.
- Always use new seals when reassembling hydraulic pumps.
- Lubricate the new rubber seals with a petroleum jelly (Vaseline®) before installation.
- Torque all bolts over gasketed joints, then repeat the torquing sequence to makeup for gasket compression.
- Verifying the accuracy of pump repairs on an authorized test stand is essential.

Identification Numbers - Manually Variable Displacement Piston Pump

Stamped on each unit's mounting flange.

- A - Product Number Description
70160 = Single Piston Pump
78162 = Single Piston Pump with Gear Pump
78161 = Tandem Piston Pumps
78163 = Tandem Piston Pumps with Gear Pump
- B - Sequential Numbering
- C - Engineering Design Code

Single Pump - Product Number:

7 0 1 6 0 - R A A - 03

A
B
C

Tandem Pumps - Product Number:

7 8 1 6 3 - R A B - 03

A
B
C

Serial Number Code:

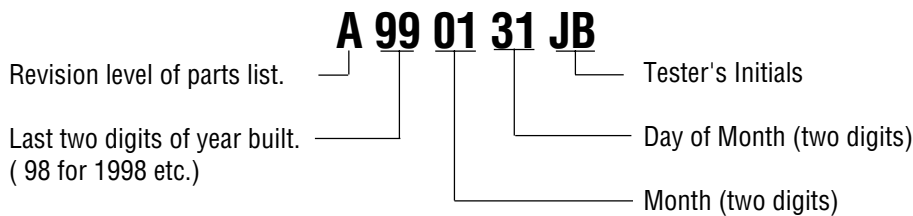

Each order must include the following information.

1. Product and/or Part Number
2. Serial Number Code
3. Part Name
4. Quantity

Tools Required

- 1/2, 9/16, 7/8 & 1-1/8 in. sockets and/or end wrenches
- Torque wrench (136 N·m [100 lbf·ft] capacity)
- Ratchet wrench
- 5/16 in. and 7/16 Allen wrenches or bit sockets
- Internal and external retaining ring pliers
- Small screwdrivers (2)
- Hammer (soft face)
- Light Petroleum Jelly
- Seal driver or similar tool

Parts Drawing

Pump drawn below is typical of a righthand rotation pump.

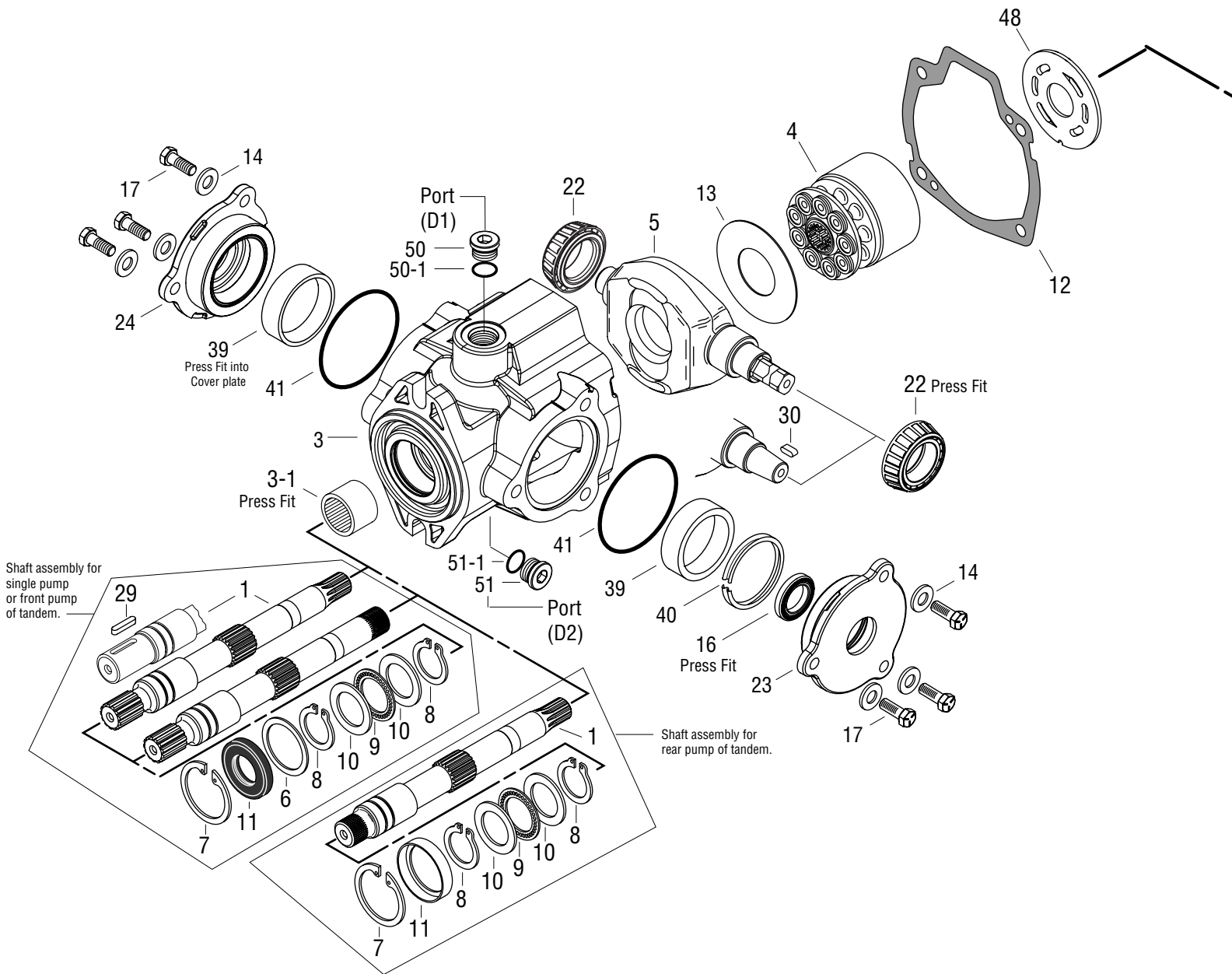

Parts Drawing

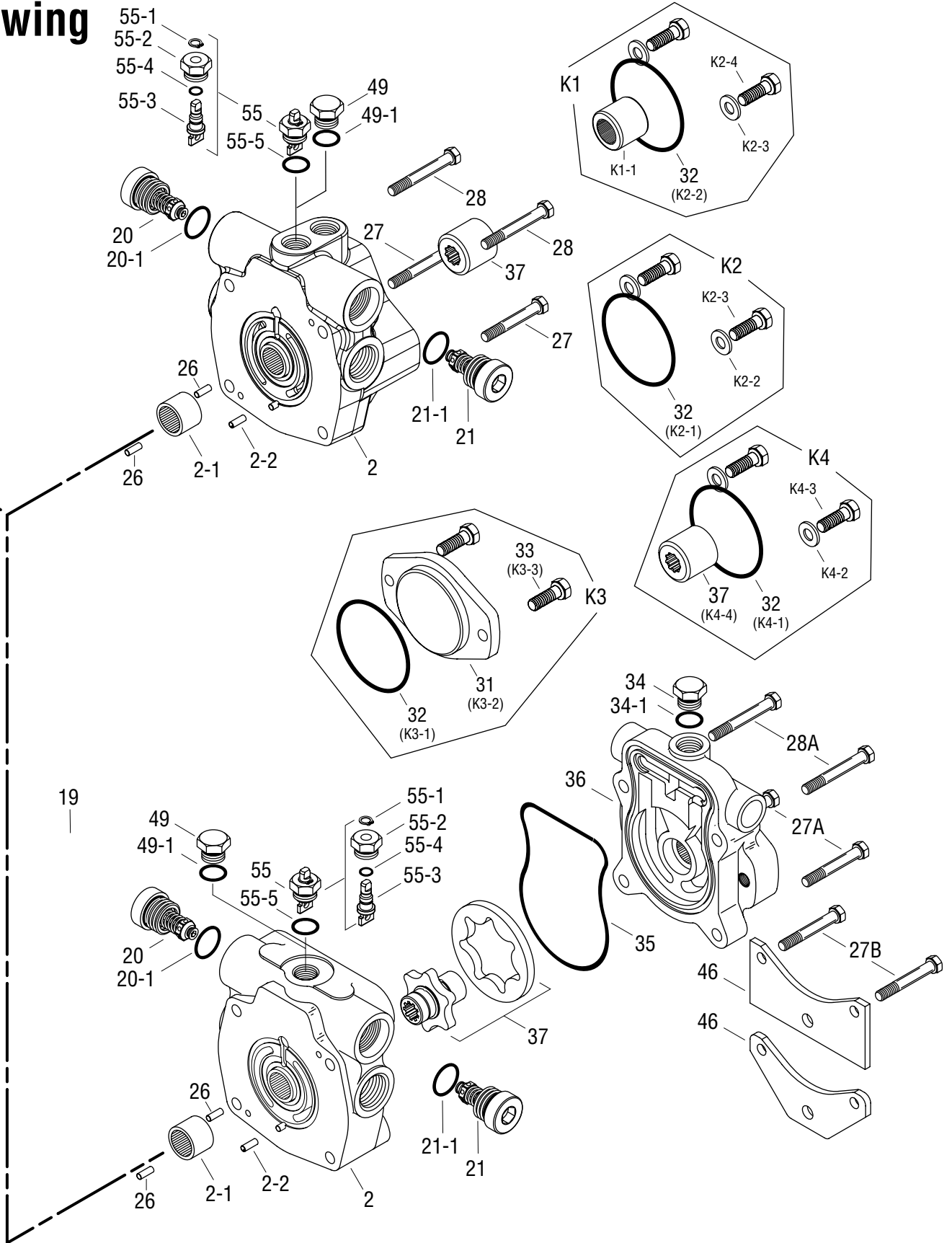

Parts List

Item	Qty.	Description
1	1	Drive Shaft
2	1	Backplate Assembly
3	1	Housing Assembly
4	1	Rotating Kit Assembly
5	1	Camplate
6	1	Washer
+ 7	1	Retaining Ring
+ 8	2	Retaining Ring
9	1	Thrust Bearing
10	2	Bearing Race
+ 11	1	Shaft Seal, Drive
11	1	Viton Shaft Seal, Drive
11	1	Spacer
+ 12	1	Housing Gasket
13	1	Camplate Insert
14	6	Washer
+ 16	1	Shaft Seal, Trunnion
17	6	Screw, Cap
20	1	for Port "C" Relief Valve S/A
+ 20-1	1	O-ring, 2.95 mm Dia. x 23,46 mm ID. [.116 in. Dia. x .924 in. ID.]
21	1	for Port "D" Relief Valve S/A
+ 21-1	1	O-ring, 2.95 mm Dia. x 23,46 mm ID. [.116 in. Dia. x .924 in. ID.]
22	2	Cone Bearing
23	1	Coverplate Sub Assembly
24	1	Coverplate Sub Assembly
26	2	Dowel Pin
27	2	Cap Screws, 5/16-18, 50.8 mm [2 in.] Long
27A	2	Cap Screws, 5/16-18, 82.6 mm [3.25 in.] Long
27B	2	Cap Screws, 5/16-18, 88.9 mm [3.5 in.] Long
28	2	Cap Screws, 5/16-18, 63.5 mm [2.5 in.] Long
28A	2	Cap Screws, 5/16-18, 95.3 mm [3.75 in.] Long
28B	2	Cap Screws, 5/16-18, 101.6 mm [4.00 in.] Long
29	1	Key, Drive Shaft
30	1	Key, Tapered Arm
31	1	Cover Plate (In K3 kit)
+ 32	1	O-ring (In K1, K2, K3, & K4 kit)
33	2	Cap Screws, Cover Plate (In K3 kit)
34	1	Plug Assembly
+ 34-1	1	O-ring, 2.21 mm Dia. x 16.36 mm ID. [.087 in. Dia. x .644 in. ID.]
+ 35	1	Molded O-ring
36	1	Charge Pump Adaptor
37	1	Gerotor set and coupler sub-assembly
37	1	9 tooth coupler (In Kit 4)
37	1	11 tooth coupler (In Kit 5)
39	2	Cup, Bearing
40	1	Ring, Crush
41	2	O-ring, 2.38 mm Dia. x 66.68 mm I.D. [.0937 in. Dia. x 2.625 in. I.D.]
42	4	Washer
46	1	Mounting Bracket, Square shaped
46	1	Mounting Bracket, "V" shaped
48	1	Valve Plate

Parts List

Item	Qty.	Description
		Righthand (CW) Rotation Lefthand (CCW) Rotation
49	1	Plug Assembly
49-1	1	Plug Assembly
+ 50-1	1	O-ring, 1.98 mm Dia. x 11.89 mm ID. [.078 in. Dia. x .468 in. ID.]
51	1	Plug Assembly
+ 51-1	1	O-ring, 1.98 mm Dia. x 11.89 mm ID. [.078 in. Dia. x .468 in. ID.]
55	1	Bypass Valve sub-assembly
+ 55-1	1	Retaining Ring
55-2	1	Separator Plug
55-3	1	Separator
+ 55-4	1	O-ring, 1.59 mm Dia. x 9.53 mm I.D. [.0625 in. Dia. x .375 in. I.D.]
+ 55-5	1	O-ring, 2.46 mm Dia. x 19.18 mm I.D. [.097 in. Dia. x .755 in. I.D.]

Mounting Kits

K1	1	Tandem Piston Pump Mounting Kit
K1-1	1	35T Coupler, 36.8 mm [1.45 in.] long
K1-2	1	O-ring, 1.59 mm Dia. x 101.6 mm ID. [.0625 in. Dia. x 4 in. ID.]
K1-3	2	Cap Screws
K1-4	2	Washer
K2	1	Gear Pump Mounting Kit
K2-1	1	O-ring, 1.59 mm Dia. x 82.55 mm ID. [.0625 in. Dia. x 3.25 in. ID.]
K2-2	2	Washer
K2-3	2	Cap Screws
K3	1	Cover Plate Kit
K3-1	1	O-ring, 1.59 mm Dia. x 82.55 mm ID. [.0625 in. Dia. x 3.25 in. ID.]
K3-2	1	Cover Plate
K3-3	2	Cap Screws
K4	1	Gear Pump Mounting Kit with Coupler
K4-1	1	O-ring, 1.59 mm Dia. x 101.6 mm ID. [.0625 in. Dia. x 4 in. ID.]
K4-2	2	Washer
K4-3	2	Cap Screws
K4-4	1	9T Coupler

Seal Repair Kit

•	1	Seal Repair Kit (see Parts Manual for part numbers)
---	---	---

Legend + Included in seal repair kit.

Repair Information - Disassembly

Disassembly

The following disassembly procedure applies to a single pump with or without gear pump. The repair procedure for tandem pumps, once they are separated, is basically the same. The basic configuration differences between a single and tandem pumps are the backplates, pump shafts and housing assemblies. In most cases, only the rear pump of tandem units contain a charge pump, which is common to both the front and rear pump. The rear tandem pump does not incorporate a shaft seal.

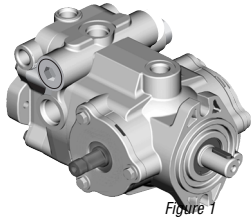

Figure 1

Thoroughly clean the Eaton Model 70160 or 78162 variable displacement pump before any repairs are attempted. When working on tandem pumps, separate the front and rear pumps first.

1 Support the pump with the input shaft down. Use a 1/2 in. socket or end wrench to remove the pump adapter cover plate or gear pump (see Figure 2).

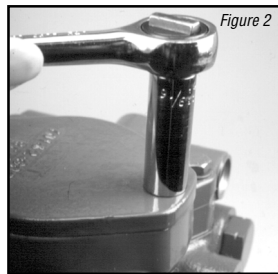

Figure 2

2 Use a pick or similar tool to remove the adapter cover plate or gear pump o-ring. (See Figure 3)

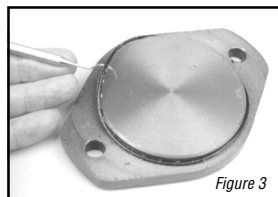

Figure 3

3 Use a 7/16 in. Allen wrench or bit socket remover to remove the charge pressure relief valve spring retainer from the pump adaptor assembly (see Figure 4).

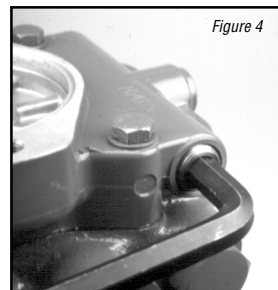

Figure 4

4 Use a pencil magnet or similar tool to carefully remove the charge pressure spring and poppet from the pump adaptor assembly. (See Figure 5) Use caution not to drop the charge pump poppet into the pump adaptor assembly.

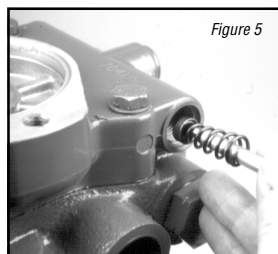

Figure 5

5 The charge pressure relief valve and poppet may be of the standard or high pressure type. The (6.9 to 10.3 bar [100 to 150 PSI]) standard spring and poppet are shown on the bottom and the optional high pressure (13.7 to 20.7 bar [200 to 300 PSI]) spring and poppet is shown on the top.

The same charge pressure relief valve spring retainer is used with either the standard or high pressure (see Figure 6).



Figure 6

6 Use a 7/8 in. socket or end wrench to remove the optional bypass valve assembly from the backplate (see Figure 7).

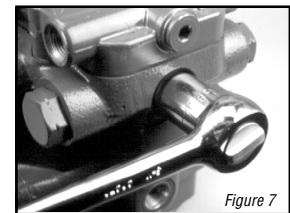

Figure 7

7 The internal seal may be replaced by first removing the small retaining ring on the end of the bypass valve. Remove and replace the o-rings (see Figure 8).

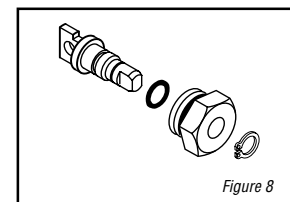

Figure 8

8 Use a 9/16 in. hex key to remove the two high pressure relief valves from the pumps backplate assembly (see Figure 9). Remove relief valve as shown from each side (see Figure 10). Each system relief valve S/A is identified by both its part number and relief valve setting as shown in Parts Information manual.

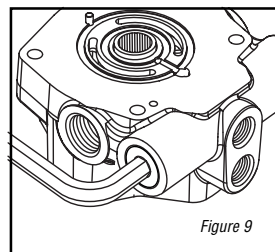

Figure 9

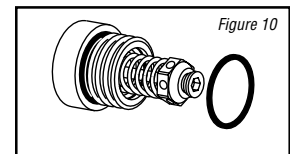

Figure 10

9 Firmly support the pump assembly. Use a 1/2 in. socket or end wrench to remove the four cap screws retaining the charge pump adaptor assembly.

10 With the cap screws removed, remove the charge pump adaptor assembly from the backplate (see Figure 11).

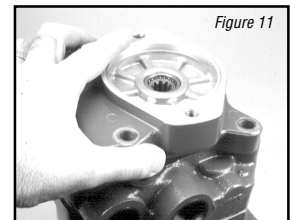

Figure 11

Note: The front pump assemblies do not have charge pump adapter assemblies.

11 Turn the adapter assembly over. Use an o-ring pick or similar tool remove the o-ring seal (see Figure 12).

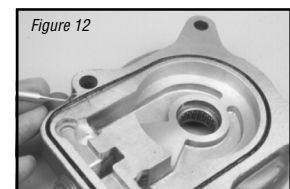
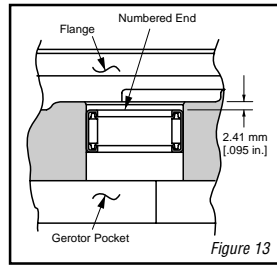

Figure 12

12 Inspect the gerotor pocket and needle bearing located in the charge pump adapter. The needles in the needle bearing must remain intact in the bearing cage.

Repair Information - Disassembly

13 When the needle bearing assembly is replaced, the numbered end of the bearing must face toward the flange side of the adapter to the dimension as shown (see Figure 13).



14 With the charge pump adapter removed, remove the charge pump outerring and inner gerotor ring assembly (see Figure 14 and 15).

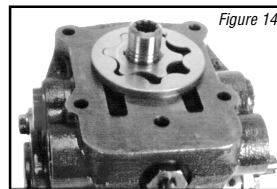

15 Charge pumps are available in two different displacements. Charge pump displacements are based on the thickness of the gerotor assembly and the depth of the pocket located in the charge pump adapter. To determine the displacement, refer to the table below.

Gerotor Pocket Depth

Displacement cm ³ /r [in ³ /r]	Depth of Pocket mm [in.]
6.9 [.42]	6.35 [.25]
13.8 [.84]	12.7 [.50]

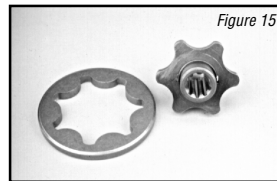

16 To separate the backplate assembly from the dowel pins in the pump housing assembly, insert two screwdrivers between backplate and housing assembly and pry upward (see Figure 16).

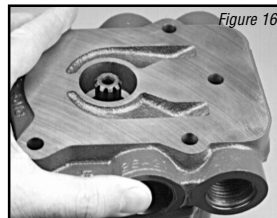

17 After separation, remove the backplate from the housing assembly.

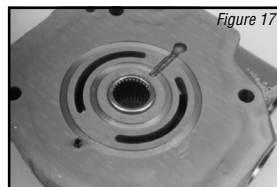

18 Turn the backplate assembly over and inspect the needle bearing. The needles in the needle bearing must remain intact in the bearing cage (see Figure 17).

19 When the needle bearing assembly is replaced, the numbered end of the bearing must face the valve plate side of the backplate to the dimension as shown (see Figure 18).

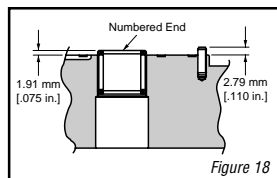

20 With the backplate removed, remove the gasket from the pump housing assembly and discard (see Figure 19).

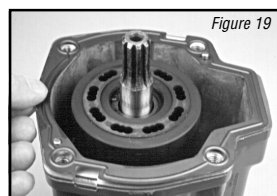

21 Remove the valve plate from the piston block assembly. Note: This valve plate may have stuck to the backplate assembly that was previously removed.

22 Valveplate directional rotation (CW or CCW) is identified by the location of the metering slots located on the face of the valve plates. Pump input rotation should always turn into the metering slots (see Figure 20). A clockwise valve plate is shown on the left and a counter clockwise valveplate is on the right.

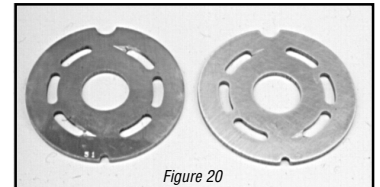

Note: Whenever pump input rotation is changed, the valve plate must be replaced along with the desired rotation charge pump adapter.

23 Remove the rotating kit assembly by carefully retaining it in the housing assembly (see Figure 21). Lift the housing and rotating kit assembly and turn over assemblies allowing the rotating kit assembly to slide down the input shaft and out of the pump housing.

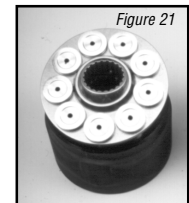

24 With the rotating kit assembly removed, remove the piston assemblies, spider and spider pivot from the piston barrel. (see Figure 22).

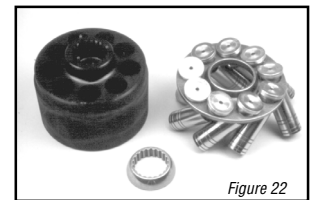

25 Inspect the piston assemblies, spider, spider pivot and piston block. The piston block assembly usually requires no further disassembly unless the pins or block spring are damaged.

26 When any excessive wear or scratches are noted on the face of the piston block, the block assembly must be replaced (see Figure 23).

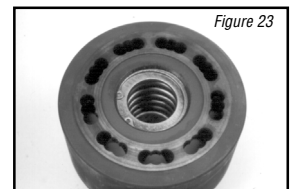

DO NOT LAP THE FACE OF PISTON BLOCK ASSEMBLY.

27 To remove the input shaft assembly, use a pair of internal snap ring pliers and remove the shaft seal retaining ring from the housing assembly (see Figure 24).

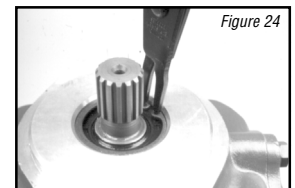

Repair Information - Disassembly

28 With the retaining ring removed, use a small press to press the shaft seal and input shaft assembly from the housing assembly.

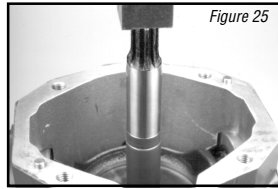

29 With the input shaft assembly removed, disassemble the assembly for inspection by removing the shaft seal, washer, retaining ring thrust washers and bearing (see Figure 26).

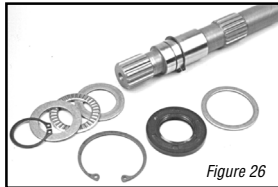

Note: The rear pump on tandem units uses a spacer in place of shaft seals.

30 To remove the camplate from the housing assembly, use a 9/16 in. socket or end wrench and remove the three cap screws and washers retaining the control arm cover plate assembly. Start at the cover plate with control arm (see Figure 27).

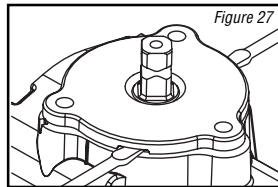

31 With the retaining cap screws removed, insert two small screwdrivers in the notches located in the cover plate assembly and pry upward. Make sure bearing cup comes off with the cover plate (see Figure 28).

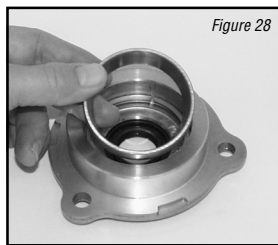

Note: The crush ring in the control arm trunnion cover does not need to be removed (see Figure 29). The only time the crush ring needs to be removed is when either the trunnion cover, the camplate assembly or the housing assembly is replaced. A shim kit is then required in the crush ring's place.

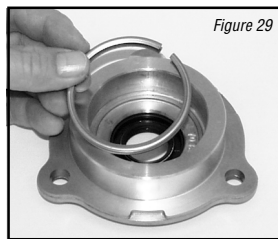

32 Reposition the pump assembly to remove opposite cover plate. The bearing cup in this cover plate is press fit and not removable. Repeat steps 30 through 31.

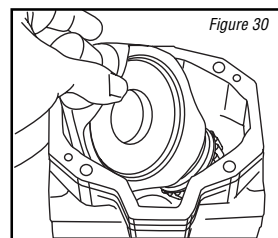

32b Remove the slip fit bearing on the non-control arm side of the camplate.

33 With housing in the upright position, slide the camplate toward the control side and lift it from the pump housing (see Figure 30).

Note: The camplate control shaft will fit out either side of the pump housing. Be sure to note on which side of the housing the control shaft protrudes before removing camplate from housing for correct reassembly orientation.

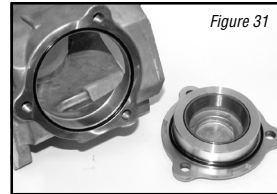

34 Use an o-ring pick or similar tool to remove the o-ring seals from the two counter-bores in the housing or the cover plates (see Figure 31).

35 To remove the control side cover plate lip seal, use a small press and press the lip seal inward (see Figure 32).

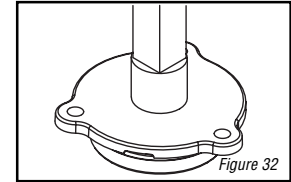

36 Remove the thrust plate from the camplate. The thrust plate is reversible and either side may face the camplate (see Figure 33).

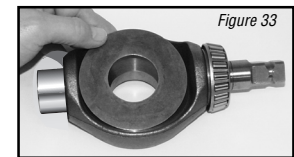

37 Inspect the housing assembly's front needle bearing. If the needles remain in their cage and move freely, replacement usually is not required (see Figure 34).

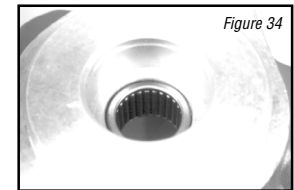

38 When the needle bearing is replaced, the numbered end of the needle bearing must face away from the housing and pressed to the dimension as shown (see Figure 35).

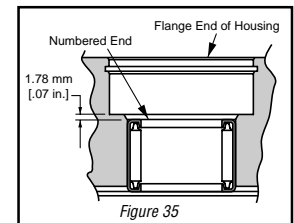

Repair Information - Reassembly

Reassembly

1 Before reassembling the pump, replace all worn and damaged parts, assemblies, seals and o-rings. Lubricate the seals and o-rings with petroleum jelly to help retain them during reassembly and to provide lubrication to the input and control shaft seals. Lubricate all finished part surfaces freely with clean hydraulic fluid to help provide start up lubrication between all rotating parts.

2 To reassemble the camplate assembly into the pump housing, tilt the camplate slightly and install the control side of the camplate through the previously noted or marked side of the housing assembly (see Figure 36).

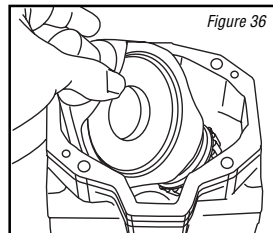

3 Lubricate the tapered bearing and reassemble it on the non-control arm side of the camplate (see Figure 37).

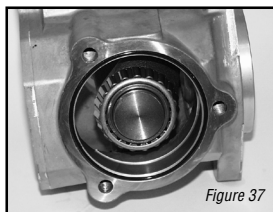

4 Lubricate and install the o-ring seal into counter-bore of housing (see Figure 37).

5 Install the trunnion cover over bearing and onto pump housing. Install the three cap screws and washers, torque screws to 39,3 Nm [29 ft-lb] (see Figure 38).

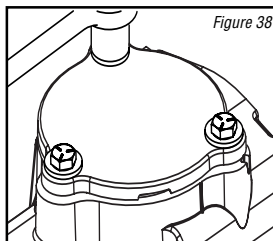

6 Lubricate and install the control arm shaft seal into the control arm cover plate. Install with the lip of the seal facing upward or to the inside of the pump (see Figure 39).

7 If the housing, trunnion covers or camplate assembly have not been replaced, the existing crush ring may be re-used. If you have replaced anyone of the above a shim kit must replace the crush ring. See Parts Information manual for number.

8 Place the bearing cup into trunnion cover over the crush ring or shims (see Figure 40).

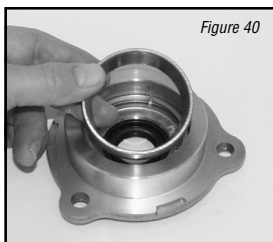
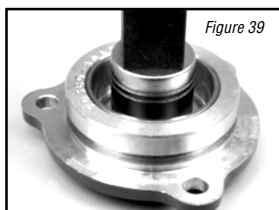

9 Lubricate and install the o-ring seal into counter-bore of housing (see Figure 41).

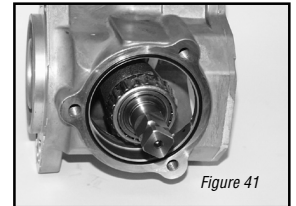

10 Install the trunnion cover over the control shaft and into the pump housing. Install the three retaining cap screws and washers, torque screws to 39,3 Nm [29 ft-lb] (see Figure 42).

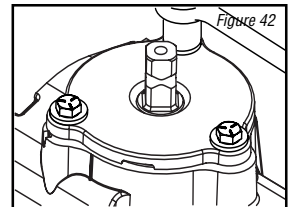

11 Using your fingers, tilt the camplate back and forth to check the trunnion bearing preload. Proper preload is achieved when the camplate has a very slight tilting resistance. The camplate must not have any or very little side clearance.

12 Reassemble the input shaft assembly by installing the thrust washer, thrust bearing, second thrust washer, retaining ring, washer and shaft seal (see Figure 43).



Note: The lip of the shaft seal must point toward the center of the input shaft.

13 Install the input shaft assembly into the housing assembly. Push the shaft seal in just far enough so you can start the shaft seal retaining ring.

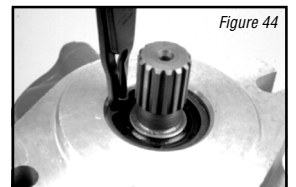

14 Use a pair of snap ring pliers to install retaining snap ring into the housing assembly (see Figure 44).

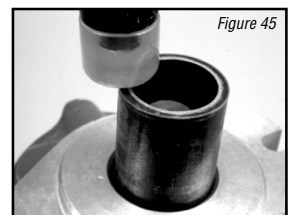

15 Use a seal driver or similar tool to press or drive the snap ring and seal into the housing assembly (see Figure 45).



CAUTION! Press or drive inward until the snap ring snaps into the snap ring groove located in the pump housing assembly.

16 The thrust plate is reversible. Either side will fit into the camplate. In most cases if any irregularities are noted it is best to replace the thrust plate (see Figure 46).

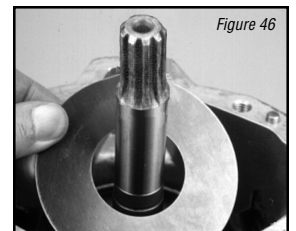

Repair Information - Reassembly

18 Lubricate and install the thrustplate over the input shaft assembly and into the camplate. The thrustplate must rest firmly in its pocket located in the camplate.

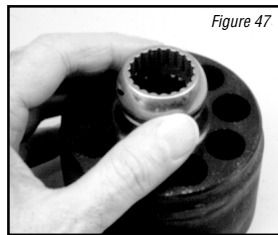

19 Reassemble the rotating kit assembly by first aligning the splines in the pivot with the splines in the block. Install the pivot on the block assembly pins (see Figure 47).



20 Use a small socket or similar tool to help retain the pivot in the centered position. Lubricate and install the spider and piston assemblies onto the pivot and pistons into the piston block assembly (see Figure 48).

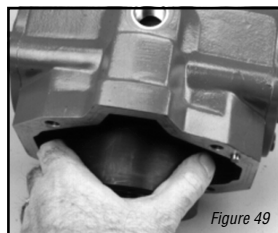

21 Hold the housing assembly in the vertical position then carefully install the rotating kit by first aligning with the splines on the input shaft. With splines aligned, install the rotating kit into the pump housing (see Figure 50). Use caution to ensure all parts are kept in their proper position.

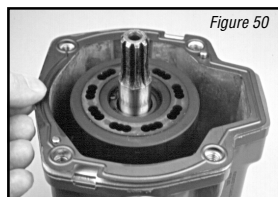

22 With the rotating kit installed, reposition the housing assembly in the input shaft down position and install a new housing gasket (see Figure 50).

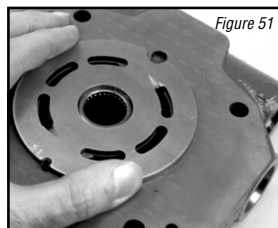

23 Lightly coat the backplate side of the valve plate with petroleum jelly for retention during assembly. Install the valve plate over the needle bearing, aligning the small slot on the outside of the valve plate with the dowel pin in the backplate (see Figure 51).

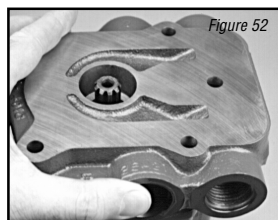

24 Carefully install the backplate assembly by aligning it with the dowel pins located in the pump housing. Use caution not to dislodge the valve plate (see Figure 54).

25 Align the spline of the gerotor's inner ring, then lubricate and install the inner ring and outer ring over the input shaft and onto the backplate assembly (see Figure 53).

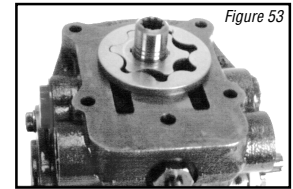

Note: Before installing the charge pump adaptor plate, offset the outer ring of the gerotor as shown.

26 With the gerotor assembly installed, install new o-ring into charge pump adapter plate and place adapter onto backplate over gerotor. Retain with cap screws. Torque cap screws to 25 N•m [18.5 lb•ft] (see Figure 54).

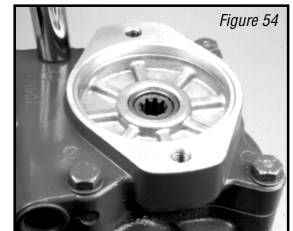

27 Install the two high pressure relief valves. Torque valves 128,8 to 142,4 Nm [95 to 105 lb-ft] (see Figure 55).

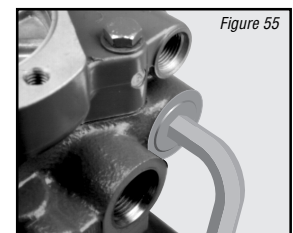

29 Lubricate and reassemble the bypass valve assembly. Install the bypass valve into the backplate. Torque valve to 30,5±2 Nm [22.5±1.5 lb-ft] (see Figure 56).

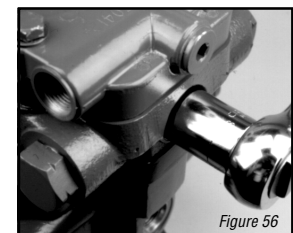

30 Coat the charge pressure poppet with petroleum jelly and place poppet onto spring and install into the adapter plate (see Figure 57).

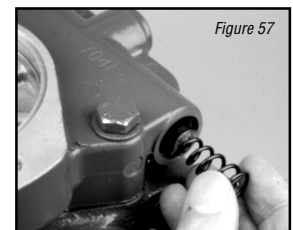

31 Install the hollow charge pressure relief valve retainer into the adapter plate. Torque retainer to 6,8 to 9,5 Nm [5 to 7 lb-ft].

32 Lubricate and install the o-ring on the cover plate or gear pump. Install the cover plate or gear pump and two cap screws. Torque cap screws to 36,6 to 40 Nm [27 to 31 lb-ft].

The Model 70160 or 78162 variable displacement pump is now ready for test and reinstallation.

Fault - Logic Troubleshooting

This fault - logic troubleshooting guide is a diagnostic aid in locating transmission problems.

Match the transmission symptoms with the problem statements and follow the action steps shown in the box diagrams. This will provide help in correcting minor problems eliminating unnecessary machine down time.

Following the fault - logic diagrams are diagram action comments of the action steps shown in the diagrams. Where applicable, the comment number of the statement appears in the action block of the diagrams.

Explanatory Diagram

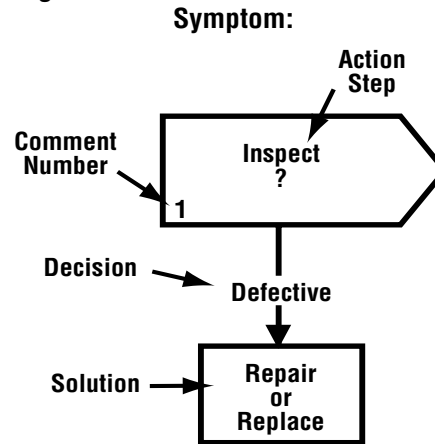

Recommended Gauge Locations

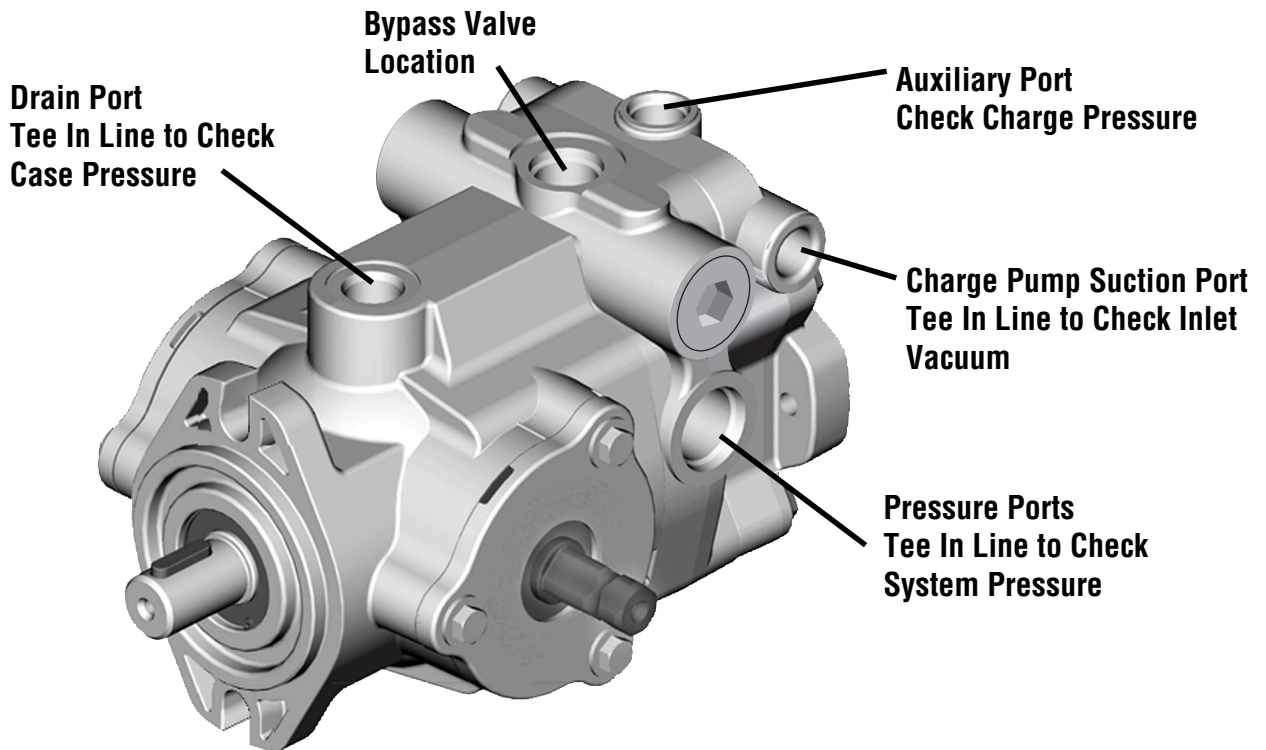

Figure 58

Gauges Recommended

- Inlet vacuum gauge: 2 bar to 1 bar [30 PSI to 30 inHg]
- System pressure gauge: 700 bar [10,000 PSI]
- Charge pressure gauge: 0 to 50 bar [0 to 600 PSI]
- Case pressure gauge: 0 to 25 bar [0 to 300 PSI]

Fault - Logic Troubleshooting

Symptom: Neutral Difficult or Impossible to Find

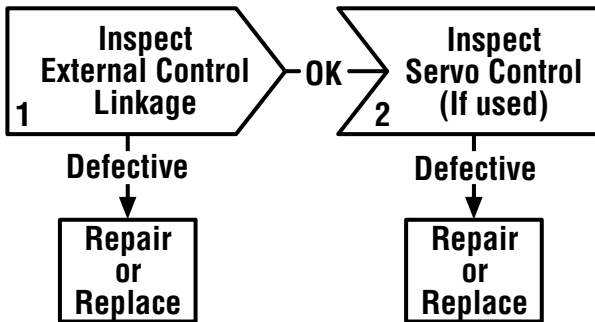

Symptom: System Operating Hot

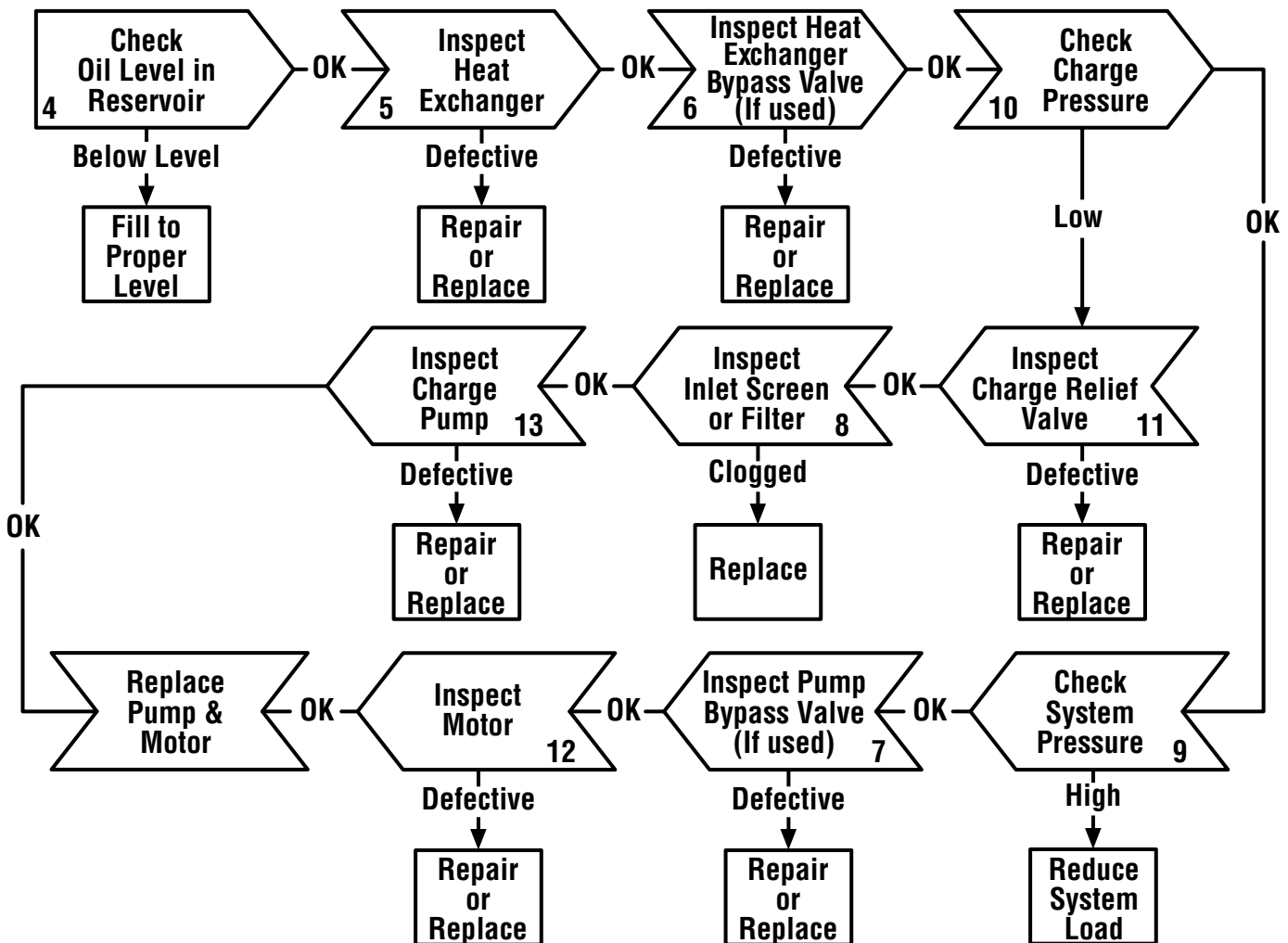

Fault - Logic Troubleshooting

Symptom: Operates in One Direction Only

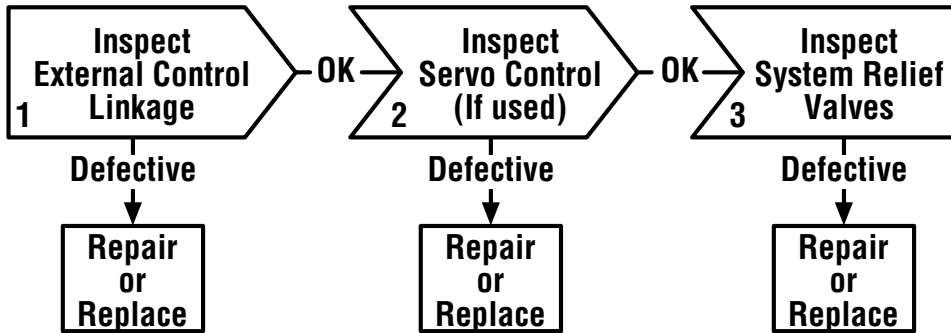

Symptom: System Response Sluggish

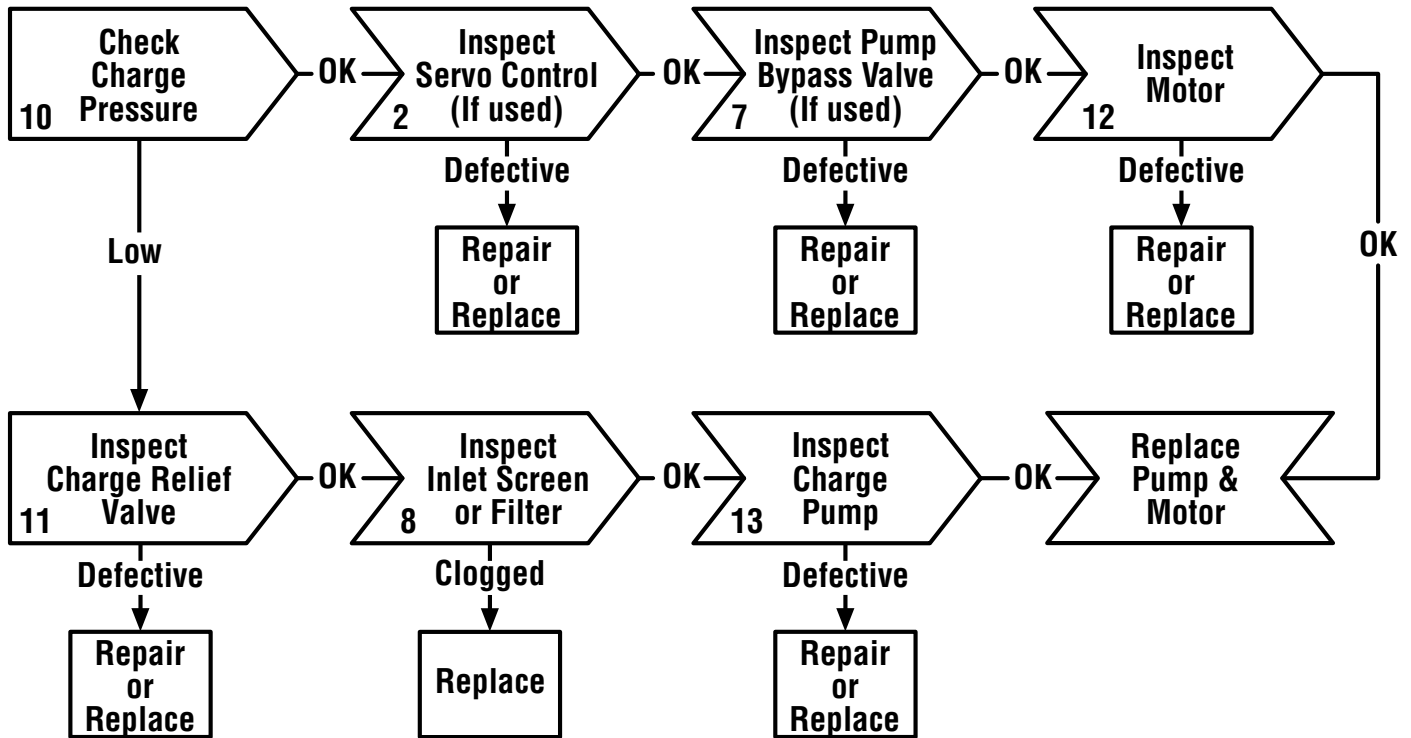

Fault - Logic Troubleshooting

Symptom: System Will Not Operate In Either Direction

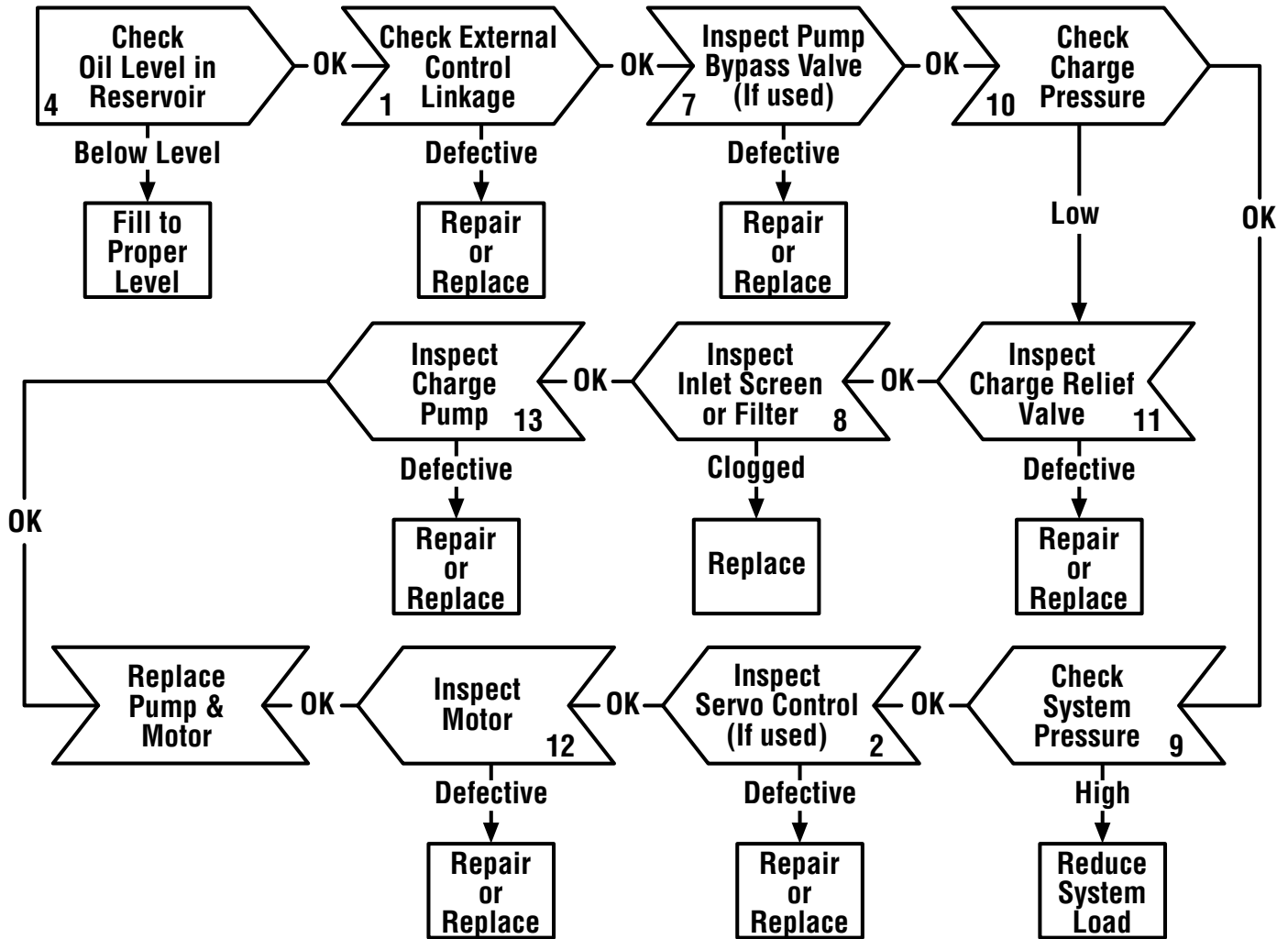

Fault - Logic Troubleshooting

Diagram Action Step Comments

- 1 Inspect External Control Linkage for:**
 - a. misadjustment or disconnection
 - b. binding, bending or breakage
 - c. misadjusted, damaged or broken neutral return spring
- 2 Inspect Servo Control Valve for: (if used)**
 - a. proper inlet pressure
 - b. misadjusted, damaged or broken neutral return spring
 - c. galled or stuck control spool
 - d. galled or stuck servo piston
- 3 Inspect System Relief Valves* for:**
 - a. improper pressure relief setting
 - b. damaged or broken spring
 - c. valve held off seat
 - d. damaged valve seat
- 4 Check Oil Level in Reservoir:**
 - a. consult owner/operators manual for the proper type fluid and level
- 5 Inspect Heat Exchanger for:**
 - a. obstructed air flow (air cooled)
 - b. obstructed water flow (water cooled)
 - c. improper plumbing (inlet to outlet)
 - d. obstructed fluid flow
- 6 Inspect Heat Exchanger Bypass Valve for: (if used)**
 - a. improper pressure adjustment
 - b. stuck or broken valve
- 7 Inspect Pump Bypass Valve for: (if used)**
 - a. held in a partial or full open position
- 8 Inspect Inlet Screen or Filter for:**
 - a. plugged or clogged screen or filter element
 - b. obstructed inlet or outlet
 - c. open inlet to charge pump
- 9 Check System Pressure:**
 - a. See figure 60 for location of pressure gauge installation.
 - b. consult owner/operators manual for maximum system relief valve settings
- 10 Check Charge Pressure:**
 - a. See figure 60 for location of pressure gauge installation.
 - b. consult owner/operators manual for maximum charge relief valve settings

- 11 Inspect Charge Relief Valve for:**
 - a. improper charge relief pressure setting *
 - b. damaged or broken spring
 - c. poppet valve held off seat
- 12 Inspect Motor for:**
 - a. disconnected coupling
- 13 Inspect Charge Pump for:**
 - a. broken or missing drive key
 - b. damaged or missing o-ring
 - c. excessive gerotor clearance
 - d. galled or broken gerotor set

*** System/Charge Relief Valve Pressure Settings for Eaton's Variable Displacement Controlled Piston Pumps**

Inlet Vacuum	6 inHg max.
Case Pressure	25 PSI maximum
Charge Pressure	100 to 150 PSI Standard 200 to 250 PSI Optional 250 to 300 PSI Optional
System Pressure	5000 PSI maximum 3000 PSI continuous

The high pressure relief valves are all factory preset and cannot be readjusted.

The pressure setting and assembly number is stamped on each high pressure relief valve cartridge.

Valve Identification Example:

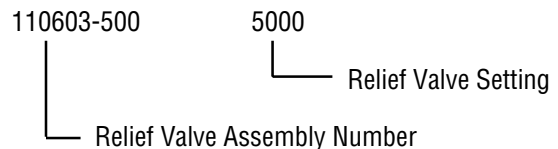

Start-up Procedure

When starting a new or rebuilt transmission system, it is extremely important to follow the start-up procedure. It prevents the chance of damaging the unit which might occur if the system was not properly purged of air before start-up.

- 1 After the transmission components have been properly installed, fill the pump housing at least half full with filtered system oil. Connect all hydraulic lines and check to be sure they are tight.
- 2 Install and adjust all control linkage.
- 3 Fill the reservoir with an approved oil that has been filtered through a 10 micron filter. Refer to Eaton Hydraulics Technical Data Sheet number 3-401 titled [Hydraulic Fluid Recommendations](#).
- 4 For Gasoline engines or L.P. engines remove the coil wire and turn the engine over for 15 seconds. For Diesel engines shut off the fuel flow to the injectors and turn the engine over for 15 seconds.
- 5 Replace the coil wire or return the fuel flow to the injectors. Place the transmission unit in the neutral position, start the engine and run it at a low idle. The charge pump should immediately pick up oil and fill the system. If there is no indication of fill in 30 seconds, stop the engine and determine the cause.
- 6 After the system starts to show signs of fill, slowly move pump camplate to a slight cam angle. Continue to operate system slowly with no load on motors until system responds fully.
- 7 Check fluid level in the reservoir and refill if necessary to the proper level with an approved filtered oil.
- 8 Check all line connections for leaks and tighten if necessary.

The machine is now ready to be put into operation.

Frequent filter changes are recommended for the first two changes after placing the machine back into operation. Change the first filter in 3-5 hours and the second in approximately 50 hours. Routinely scheduled filter changes are recommended for maximum life of the hydraulic system.

Notes:

Model 70160

Information contained in this catalog is accurate as of the publication date and is subject to change without notice. Performance values are typical values. Customers are responsible for selecting products for their applications using normal engineering methods.

Eaton Hydraulics

14615 Lone Oak Road
Eden Prairie, MN 55344
Telephone: 652 937-7254
Fax: 652 937-7130
www.eatonhydraulics.com

46 New Lane, Havant
Hampshire PO9 2NB
England
Telephone: (44) 23 92 486 451
Fax: (44) 23 92 487 110

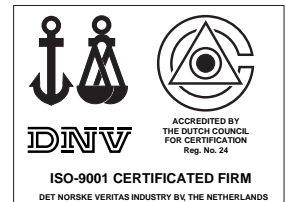

Quality System Certified
Products in this catalog are
manufactured in an
ISO-9001-certified site.



Repair Information

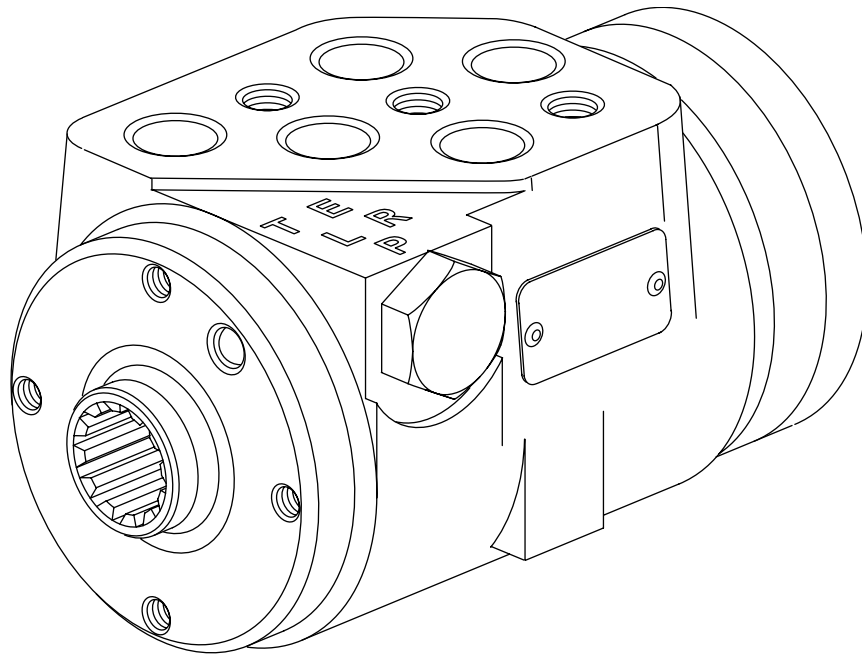

2 Series
Steering Control Unit

001

2 Series Steering Control Units

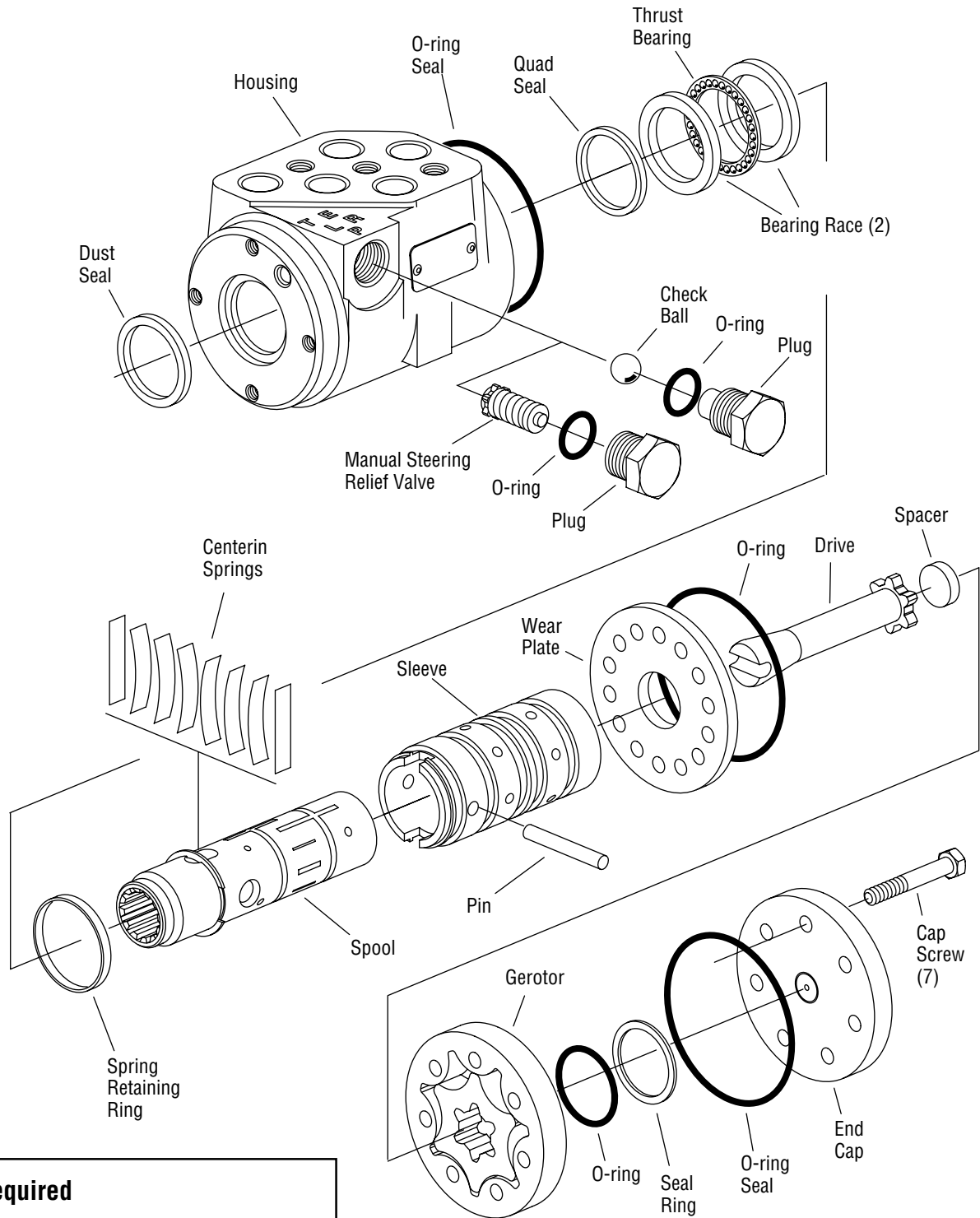

Tools Required

- 10 mm Socket
- 7/8 in. Socket
- Torque Wrench (18 Nm [160 lb-in] Capacity)
- Small Blade Screwdriver

2 Series Steering Control Units

Disassembly

Cleanliness is extremely important when repairing hydraulic Steering Control Units (SCU). Work in a clean area. Before disconnecting the hydraulic lines, clean the port area of the SCU. Before disassembly, drain the oil, then plug the ports and thoroughly clean the exterior of the SCU. During repairs, always protect machined surfaces.

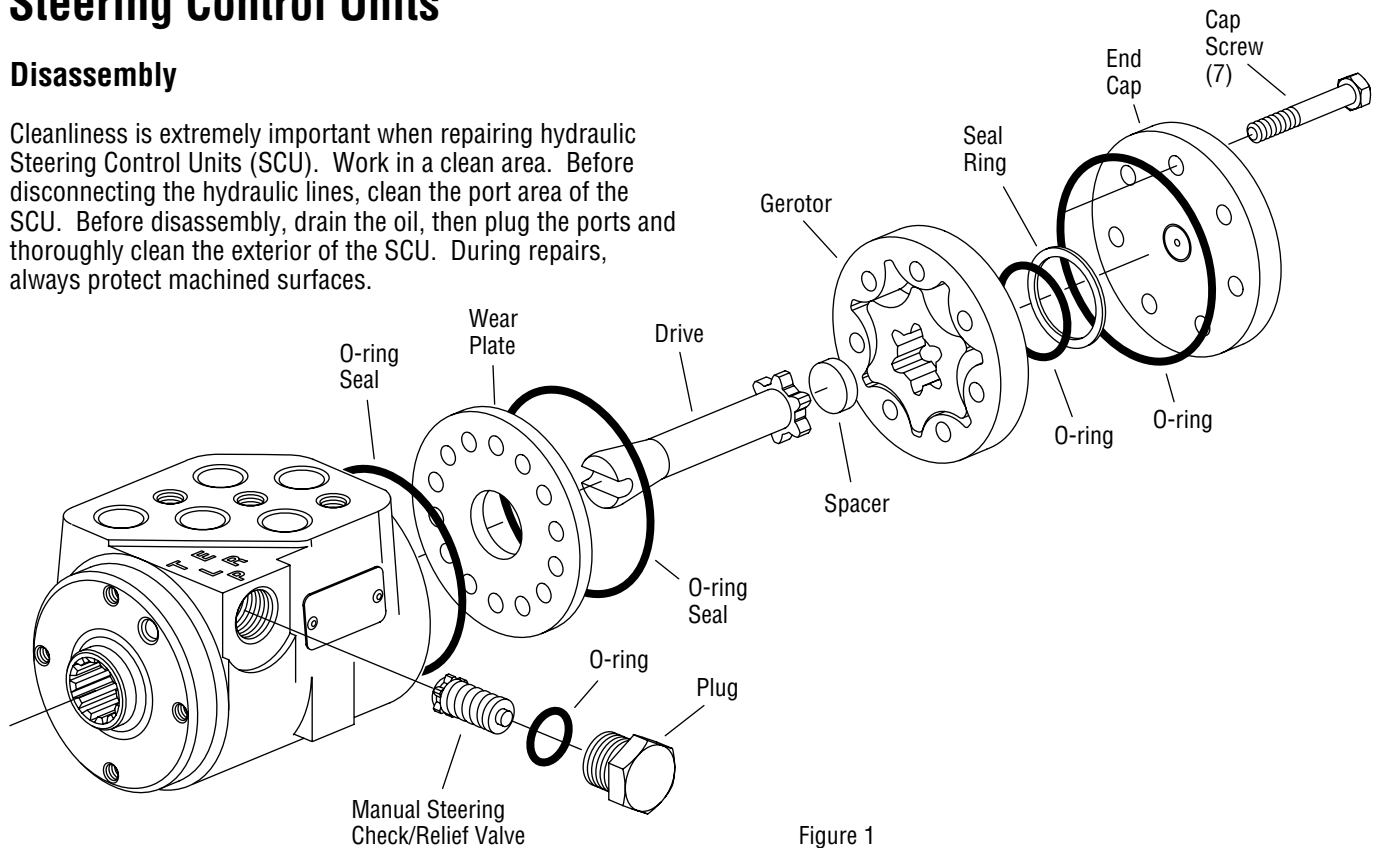

Figure 1

1 Remove the seven cap screws and disassemble the SCU as shown in Figure 1.

2 Remove the plug and manual steering check as shown in Figure 1.

Note: The manual steering check may be a check ball or a check/relief valve.

3 Slide the spool and sleeve from the housing (see Figure 2).

4 Remove the thrust bearing and bearing races.

5 Remove the quad seal.

6 Using a small blade screwdriver, carefully pry the dust seal from the housing.

Important: Do not damage the dust seal seat.

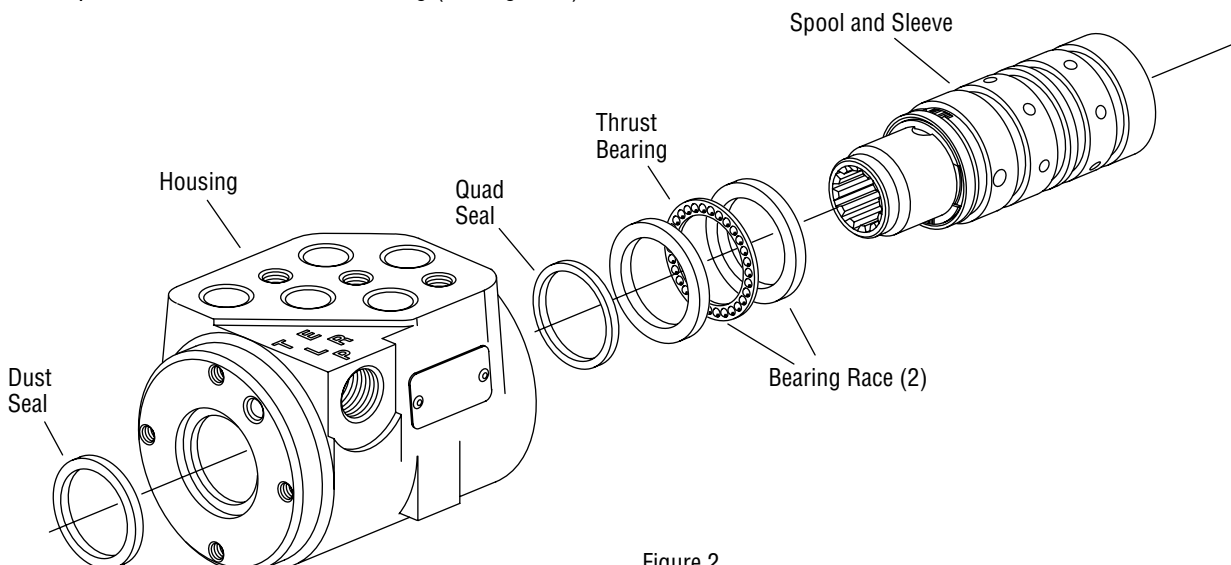

Figure 2

2 Series Steering Control Units

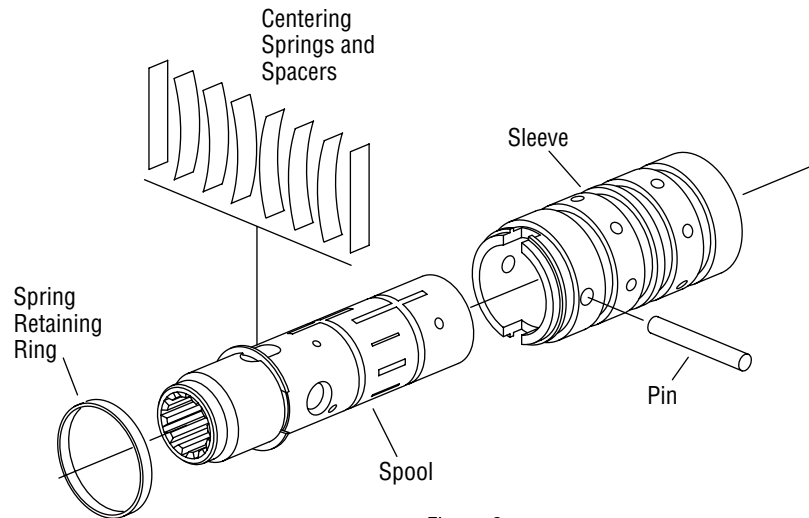

Figure 3

7 Remove the pin that holds the spool and sleeve together (see Figure 3).

8 Carefully slide the spool out of the sleeve. The springs and retaining ring will stay with the spool as it's removed.

9 Remove the retaining ring and springs.

Caution: The centering springs are under tension. Remove the retaining ring carefully.

Reassembly

Check all mating surfaces. Replace any parts with scratches or burrs that could cause leakage. Wash all metal parts in clean solvent. Blow them dry with pressurized air. **Do not** wipe parts dry with paper towels or cloth as lint in a hydraulic system will cause damage.

Note: Always use new seals when reassembling hydraulic steering control units. Refer to parts list 6-323 for seal kit part numbers, replacement parts, and ordering information.

Important: During reassembly lubricate the new seals with a petroleum jelly such as Vaseline®. Also lubricate machined surfaces and bearings with clean hydraulic fluid.

10 Install the quad seal:

- Put one of the bearing races and sleeve into the housing.
- Together, the housing and bearing race create a groove into which the quad seal will be installed.
- Hold the bearing race tightly against the input end of the housing by pushing on the gerotor end of the sleeve.
- Fit the quad seal into its seat through the input end of the housing. Be sure the seal is not twisted.
- Remove the sleeve and bearing race.

2 Series Steering Control Units

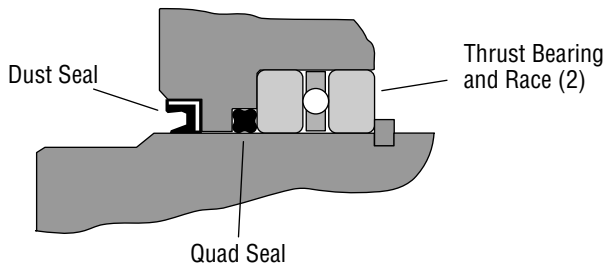

Figure 4

- 11** Lubricate and install the dust seal (see Figure 4 for correct seal orientation).
- 12** Install the centering springs in the spool. It is best to install the two flat pieces first. Next, install the curved pieces, three at a time.
- 13** Fit the retaining ring over the centering springs.
- 14** Apply a light coating of clean hydraulic fluid to the spool and slide it into the sleeve. Be sure the centering springs fit into the notches in the sleeve.
- 15** Install the pin (see Figure 3).
- 16** Apply a light coating of petroleum jelly to the inner edge of the dust and quad seals.
- 17** Put the thrust bearing and races into the housing. The thrust bearing goes between the two races (see Figure 2).
- 18** Apply a light coating of clean hydraulic fluid to the spool and sleeve assembly and slide it into the housing.
- Important: Do not damage the dust or quad seals.**
- 19** Clamp the housing in a vise as shown in Figure 5. Use just enough clamping force to hold the housing securely.

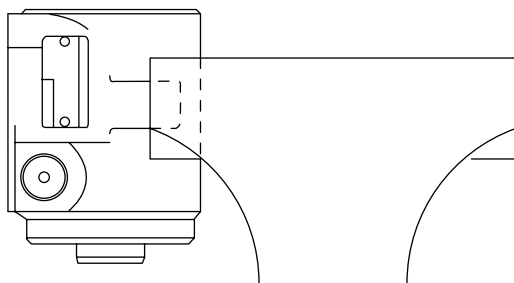

Figure 5

- 20** Lubricate and install a new o-ring seal in the groove in the housing.
- 21** Install the wear plate and align the holes in the wear plate with threaded holes in the housing.
- Note: The holes in the wear plate are symmetrical.**
- 22** Install the drive, be sure the slot in the drive engages the pin.
- 23** Lubricate and install a new o-ring seal in the groove in the wear plate.
- 24** Install the gerotor and align the screw holes.
- 25** Lubricate and install a new o-ring seal in the groove in the gerotor ring.
- 26** Lubricate and install a new o-ring and seal ring in the groove in the gerotor star.
- 27** Install the spacer.
- 28** Install end cap and seven cap screws. Tighten cap screws, in a crisscross pattern, to 16 -18 Nm [140 -160 lb-in].
- 29** Remove the SCU from the vise.
- 30** Install the relief valve/check or check ball and plug. Use a new o-ring and tighten the plug to 17 Nm [150 lb-in].

2 Series Steering Control Units

Product Numbers 2 Series (Standard — 69 Bar [1000 PSI])

System	Ports	Relief Valve Setting Bar [PSI]	Displacement cm ³ /r [in ³ /r] and Product Number					
			31 [1.9]	39 [2.4]	51 [3.1]	63 [3.8]	74 [4.5]	100 [6.1]
Open Center Non-Load Reaction	9/16 Inch Plug-O (4)	None	291-1001-001	291-1002-001	291-1003-001	291-1004-001	291-1005-001	291-1006-001
		40 [580]	291-1001-041	291-1002-041	291-1003-041	291-1004-041	291-1005-041	291-1006-041
		50 [725]	291-1001-051	291-1002-051	291-1003-051	291-1004-051	291-1005-051	291-1006-051
		63 [914]	291-1001-061	291-1002-061	291-1003-061	291-1004-061	291-1005-061	291-1006-061
		70 [1015]	291-1001-071	291-1002-071	291-1003-071	291-1004-071	291-1005-071	291-1006-071
	9/16 -18 Inch SAE (4)	None	291-1007-001	291-1008-001	291-1009-001	291-1010-001	291-1011-001	291-1012-001
		40 [580]	291-1007-041	291-1008-041	291-1009-041	291-1010-041	291-1011-041	291-1012-041
		50 [725]	291-1007-051	291-1008-051	291-1009-051	291-1010-051	291-1011-051	291-1012-051
		63 [914]	291-1007-061	291-1008-061	291-1009-061	291-1010-061	291-1011-061	291-1012-061
		70 [1015]	291-1007-071	291-1008-071	291-1009-071	291-1010-071	291-1011-071	291-1012-071
Power Beyond Non-Load Reaction	9/16 Inch Plug-O (5)	None	291-5001-001	291-5002-001	291-5003-001	291-5004-001	291-5005-001	291-5006-001
		40 [580]	291-5001-041	291-5002-041	291-5003-041	291-5004-041	291-5005-041	291-5006-041
		50 [725]	291-5001-051	291-5002-051	291-5003-051	291-5004-051	291-5005-051	291-5006-051
		63 [914]	291-5001-061	291-5002-061	291-5003-061	291-5004-061	291-5005-061	291-5006-061
		70 [1015]	291-5001-071	291-5002-071	291-5003-071	291-5004-071	291-5005-071	291-5006-071
	9/16 -18 Inch SAE (5)	None	291-5007-001	291-5008-001	291-5009-001	291-5010-001	291-5011-001	291-5012-001
		40 [580]	291-5007-041	291-5008-041	291-5009-041	291-5010-041	291-5011-041	291-5012-041
		50 [725]	291-5007-051	291-5008-051	291-5009-051	291-5010-051	291-5011-051	291-5012-051
		63 [914]	291-5007-061	291-5008-061	291-5009-061	291-5010-061	291-5011-061	291-5012-061
		70 [1015]	291-5007-071	291-5008-071	291-5009-071	291-5010-071	291-5011-071	291-5012-071
Dynamic Signal Load Sensing	9/16 Inch Plug-O (5)	None	293-4001-001	293-4002-001	293-4003-001	293-4004-001	293-4005-001	293-4006-001
	9/16 -18 Inch SAE (5)	None	293-4007-001	293-4008-001	293-4009-001	293-4010-001	293-4011-001	293-4012-001

Product Numbers 2 Series (High Pressure — 103 Bar [1500 PSI])

Open Center Non-Load Reaction	9/16 Inch Plug-O (4)	None	291-1001-121	291-1002-121	291-1003-121	291-1004-121	291-1005-121	291-1006-121		
		80 [1160]	291-1001-081	291-1002-081	291-1003-081	291-1004-081	291-1005-081	291-1006-081		
		90 [1305]	291-1001-091	291-1002-091	291-1003-091	291-1004-091	291-1005-091	291-1006-091		
		100 [1450]	291-1001-101	291-1002-101	291-1003-101	291-1004-101	291-1005-101	291-1006-101		
	9/16 -18 Inch SAE (4)	None	291-1007-121	291-1008-121	291-1009-121	291-1010-121	291-1011-121	291-1012-121		
		80 [1160]	291-1007-081	291-1008-081	291-1009-081	291-1010-081	291-1011-081	291-1012-081		
		90 [1305]	291-1007-091	291-1008-091	291-1009-091	291-1010-091	291-1011-091	291-1012-091		
		100 [1450]	291-1007-101	291-1008-101	291-1009-101	291-1010-101	291-1011-101	291-1012-101		
		Power Beyond Non-Load Reaction	9/16 Inch Plug-O (5)	None	291-5001-121	291-5002-121	291-5003-121	291-5004-121	291-5005-121	291-5006-121
				80 [1160]	291-5001-081	291-5002-081	291-5003-081	291-5004-081	291-5005-081	291-5006-081
90 [1305]	291-5001-091	291-5002-091		291-5003-091	291-5004-091	291-5005-091	291-5006-091			
100 [1450]	291-5001-101	291-5002-101		291-5003-101	291-5004-101	291-5005-101	291-5006-101			
9/16 -18 Inch SAE (5)	None	291-5007-121	291-5008-121	291-5009-121	291-5010-121	291-5011-121	291-5012-121			
	80 [1160]	291-5007-081	291-5008-081	291-5009-081	291-5010-081	291-5011-081	291-5012-081			
	90 [1305]	291-5007-091	291-5008-091	291-5009-091	291-5010-091	291-5011-091	291-5012-091			
	100 [1450]	291-5007-101	291-5008-101	291-5009-101	291-5010-101	291-5011-101	291-5012-101			
Dynamic Signal Load Sensing	9/16 Inch Plug-O (5)	None	293-4001-121	293-4002-121	293-4003-121	293-4004-121	293-4005-121	293-4006-121		
	9/16 -18 Inch SAE (5)	None	293-4007-121	293-4008-121	293-4009-121	293-4010-121	293-4011-121	293-4012-121		

2 Series Steering Control Units

2 Series Steering Control Units

How to Order Replacement Parts

Each Order Must Include the Following:

1. Product Number
2. Date Code
3. Part Name
4. Part Number
5. Quantity of Parts

For More Detailed Information Contact Eaton Corp. Hydraulics Division 15151 Highway 5 Eden Prairie, MN 55344.

- Specifications and performance data, Catalog No. 11-872
- Replacement part numbers and kit information — Parts Information No. 7-310.

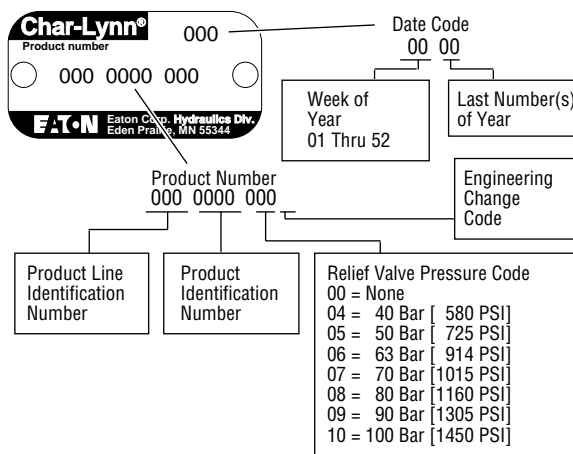

Eaton Corporation
Hydraulics Division
15151 Hwy. 5
Eden Prairie, MN 55344
Telephone 612/937-9800
Fax 612/937-7130

Eaton Ltd.
Hydraulics Division
Glenrothes, Fife
Scotland, KY7 4NW
Telephone 01-592-771-771
Fax 01-592-773-184

Eaton GmbH
Hydraulics Products
Am Schimmersfeld 7
40880 Ratingen, Germany
Telephone 02102-406-830
Fax 02102-406-800



Quality System Certified
Products in this catalog are manufactured
in an ISO-9001-certified site.



Repair Information

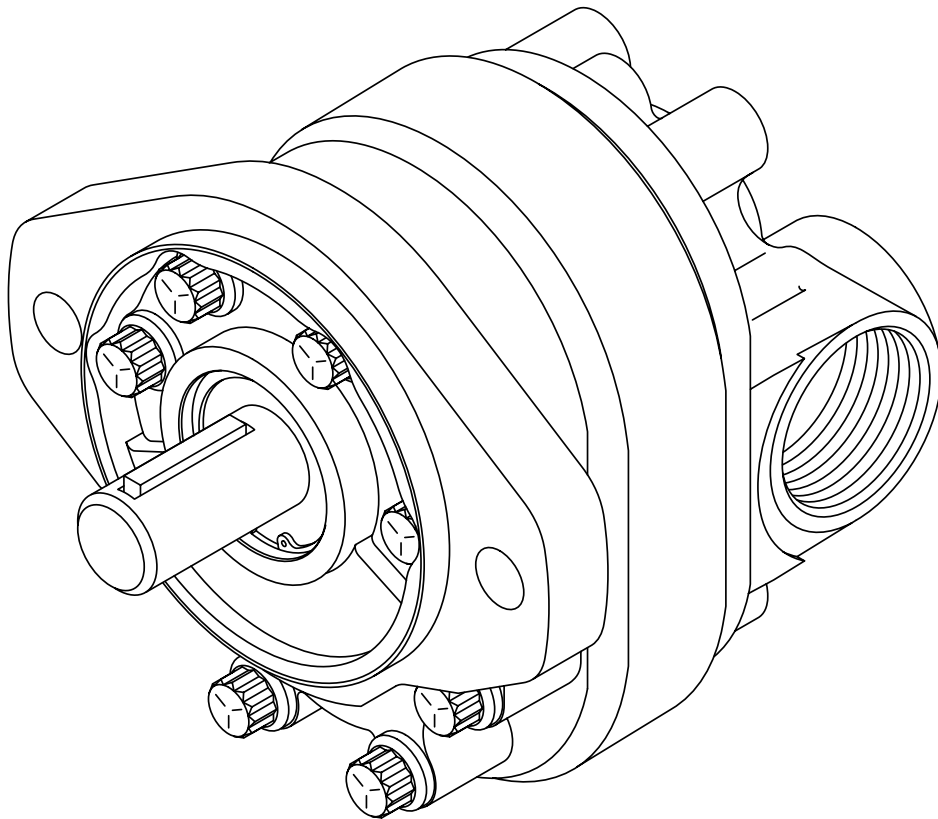

Series 26
Model 26000 Single Gear Pumps

Introduction

Table of Contents

Introduction	2
Identification	3
Tools Required	3
Exploded View Drawing	4
Parts List	5
Disassembly	5 & 6
Reversibility	7
Inspection	8
Reassembly	9 & 10
Specific Backplate Parts List	11 & 12
Placing Pump Back into Operation	13
Trouble Shooting	14
Ordering Information	16

Introduction

This manual provides service information for the Eaton model 26000 single gear pumps. Step by step instructions for the complete disassembly, inspection, and reassembly of the pumps are included.

The following recommendations should be followed to insure successful repairs.

- Remove the pump from the application.
- Cleanliness is extremely important.
- Clean the port areas thoroughly before disconnecting the hydraulic lines.
- Plug the pump ports and cover the open hydraulic lines immediately after they're disconnected.
- Drain the oil and clean the exterior of the pump before making repairs.
- Wash all metal parts in clean solvent.
- Use compressed air to dry the parts. Do not wipe them dry with paper towels or cloth.
- The compressed air should be filtered and moisture free.
- Always use new seals when reassembling hydraulic pumps.
- For replacement parts and ordering information refer to parts list 6-634.
- Lubricate the new rubber seals with a petroleum jelly (vaseline) before installation.
- Torque all bolts over gasket joints, then repeat the torquing sequence to makeup for gasket compression.
- Verifying the accuracy of pump repairs on an authorized test stand is essential.

Identification and Tools Required

Product Number: 26 0 01 - R Z A

Series _____
 26 = Gear Pump
 (SAE "A" Mount)

Features _____
 0 = Standard Single Pump
 1 = Standard Single W/ Relief
 2 = Flow Divider Backplate
 3 = Flow Divider W/ Load Sense
 4 = Tandem Backplate
 5 = Multiple Pumps

Displacement cm³/r [in³ /r] _____
 01 = 6.6 [.40] 08 = 22.5 [1.37]
 02 = 8.2 [.50] 09 = 24.3 [1.48]
 03 = 9.5 [.58] 10 = 25.2 [1.54]
 04 = 10.8 [.66] 11 = 27.7 [1.69]
 05 = 13.8 [.84] 12 = 29.0 [1.77]
 06 = 16.7 [1.02] 13 = 30.6 [1.87]
 07 = 19.7 [1.20]

Input Rotation _____
 R = Right-hand (clockwise)
 L = Left-hand (Counterclockwise)

Catalog / Non-Catalog _____
 Z = Cataloged Pump
 A-Y = Non-Cataloged Pump

Shafts , Porting Size and Location _____

B 95 01 31 JB Serial Number Code:

_____ Testers Initials
 _____ Day of Month (two digits)
 _____ Month (two digits)
 _____ Last two digits of year built.
 (95 for 1995 etc.)
 _____ Revision level of parts list.

Side Ports

- A = 3/4 in. 11 Tooth, 1 5/16-12 UN-2B Suction, 7/8-14 UNF-2B Pressure
- C = 3/4 in. Str. Keyed, 1 5/16-12 UN-2B Suction, 7/8-14 UNF-2B Pressure
- E = 3/4 in. 9 Tooth, 1 5/16-12 UN-2B Suction, 7/8-14 UNF-2B Pressure
- G = 5/8 in. Str. Keyed, 1 1/16-12 UN-2B Suction, 7/8-14 UNF-2B Pressure
- J = 5/8 in. 9 Tooth, 1 1/16-12 UN-2B Suction, 7/8-14 UNF-2B Pressure
- L = 5/8 in. Str. Keyed, 1 5/16-12 UN-2B Suction, 7/8-14 UNF-2B Pressure
- N = 3/4 in. 11 Tooth, 1 1/16-12 UN-2B Suction, 7/8-14 UNF-2B Pressure
- R = 3/4 in. Str. Keyed, 1 1/16-12 UN-2B Suction, 7/8-14 UNF-2B Pressure

Rear Ports

- B = 3/4 in. 11 Tooth, 1 5/16-12 UN-2B Suction, 7/8-14 UNF-2B Pressure
- D = 3/4 in. Str. Keyed, 1 5/16-12 UN-2B Suction, 7/8-14 UNF-2B Pressure
- F = 3/4 in. 9 Tooth, 1 5/16-12 UN-2B Suction, 7/8-14 UNF-2B Pressure
- H = 5/8 in. Str. Keyed, 1 1/16-12 UN-2B Suction, 7/8-14 UNF-2B Pressure
- K = 5/8 in. 9 Tooth, 1 1/16-12 UN-2B Suction, 7/8-14 UNF-2B Pressure
- M = 5/8 in. Str. Keyed, 1 5/16-12 UN-2B Suction, 7/8-14 UNF-2B Pressure
- P = 3/4 in. 11 Tooth, 1 1/16-12 UN-2B Suction, 7/8-14 UNF-2B Pressure
- S = 3/4 in. Str. Keyed, 1 1/16-12 UN-2B Suction, 7/8-14 UNF-2B Pressure

Tools Required

- 3/8 in. socket and ratchet wrench
- Internal Retaining Ring Pliers (straight .090 tip)
- O-ring Pick
- Thread 3/8 dia. UNC bolt/screw
- Torque Wrench (135.6 N-m [100 lbf-ft] capacity)
- Hammer (soft face)
- Light Petroleum Jelly
- Seal Driver
- Arbor Press

Parts Drawing

Righthand (CW) Rotation Pump

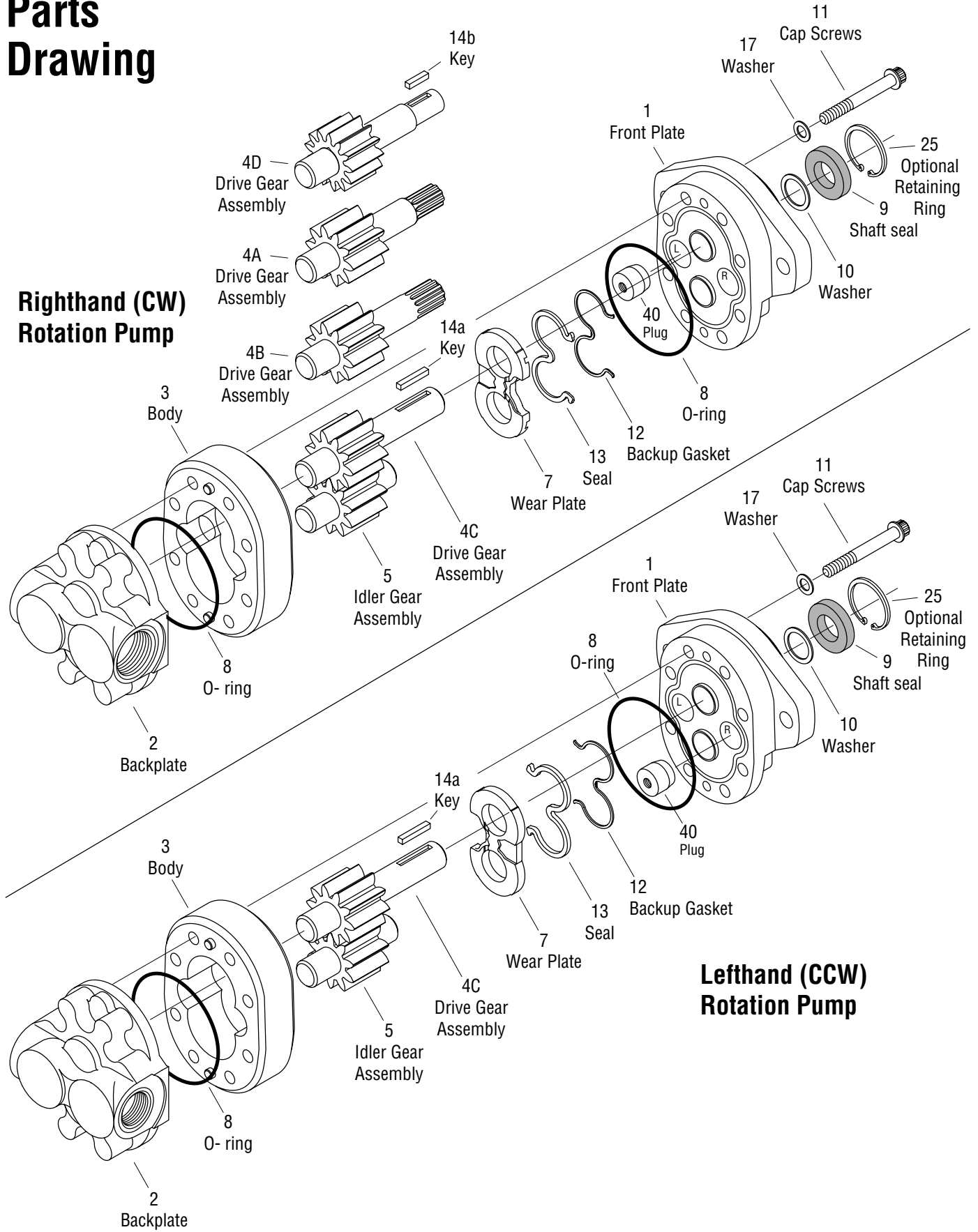

Lefthand (CCW) Rotation Pump

Disassembly

Repair Information - Model 26000

Work in a clean area; cleanliness is extremely important when repairing hydraulic pumps. Before disconnecting the lines, clean port area of pump. Disconnect hydraulic lines, removing pump assembly from vehicle and plugging ports. Thoroughly clean the outside of pump. After cleaning, remove port plugs and drain oil.

Disassembly

- 1 Remove *key* from drive shaft if keyed drive gear assembly is used.
- 2 Put a *location mark* across front plate, body and backplate to assure proper reassembly.
- 3 Clamp pump in vise, shaft end up.
- 4 Remove *cap screws* (eight each) and washer (four each).
- 5 Remove pump from vise, hold pump in hands and tap shaft with plastic hammer or rawhide mallet to separate front plate from backplate. Body will remain with either front plate or backplate.

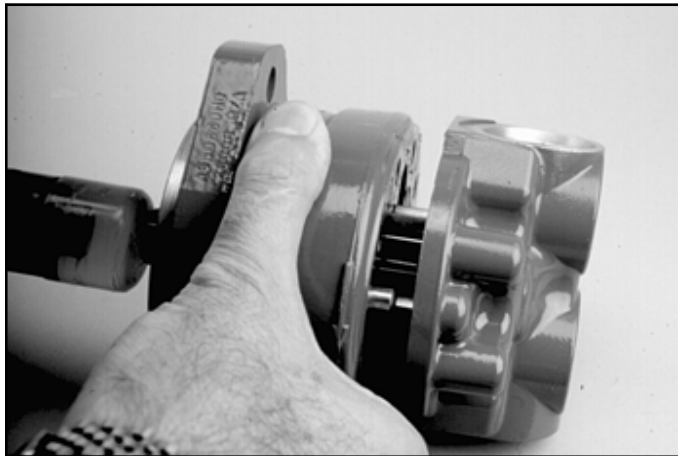

Parts List

Item No.	Description	Qty.
1	Front plate Assembly	1
2	Backplate	1
3	Body Assembly	1
4	Drive Gear Assembly	1
5	Idler Gear Assembly	1
~ 7	Wear Plate	1
~ 8	O-ring	2
~ 9	Shaft Seal	1
~ 10	Washer	1
11	Cap Screw	8
~ 12	Backup Gasket	1
~ 13	Seal	1
14	Key for Straight Shaft	1
~ 17	Washer	4
25	Retaining Ring (optional)	1
40	Plug	1
~ Seal Kit	26000-901 for Single Pumps	

- 6 Remove *o-ring* seal from backplate.

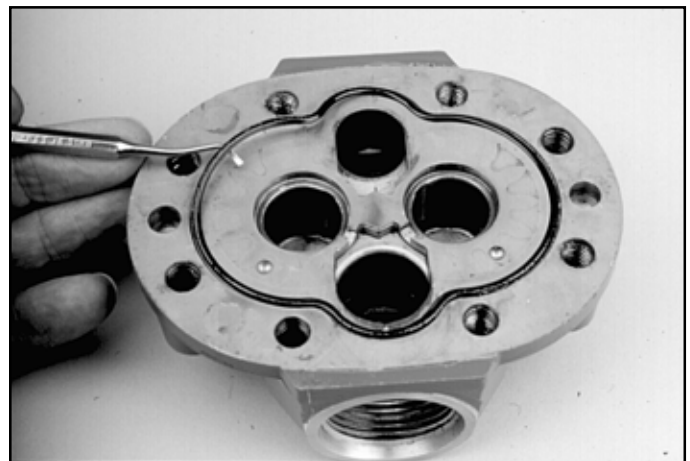

- 7 To disassemble the *relief valve backplate, flow divider backplate, and tandem flow divider backplate* see page 11 & 12.

Disassembly

8 Remove *idler gear assembly* from body.

9 To separate *body* from the plate it remained with, place *drive gear assembly* in gear pocket and tap protruding end with plastic hammer or rawhide mallet. Remove drive gear assembly.

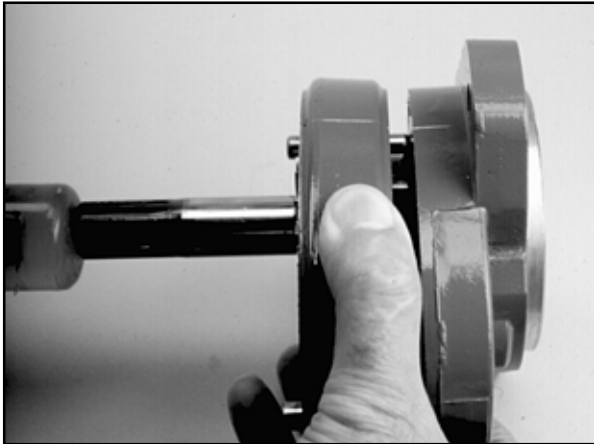

10 Remove wear plate and o-ring seal, noting position of open side of wear plate.

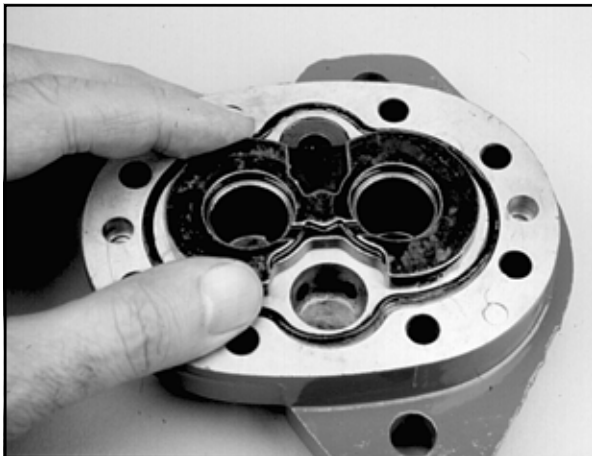

11 Remove *back-up gasket and seal* from wear plate by extracting with a o-ring tool.



12 Remove snap ring (if applicable) from the front of the front plate shaft seal area.

13 Remove *shaft seal* and *washer* from front plate with a blunt punch from the back side.



14 Removing the *plug* in front plate is not necessary, unless you intend to change rotation. See Reversibility - Changing Input Rotation of Pump.

Reversibility

Changing Input Rotation of Pump

1 Place pump in a protected jaw vise with shaft end up. Remove the eight cap screws.

2 Remove front plate, noting orientation of drive shaft through bearing in reference to the backplate.

3 Notice the location of the open side of wear plate and remove wear plate.

4 Switch *drive gear and idler gear* within gear pockets. Do not flip idler gear end for end.

Note: Gear housing body and backplate do not need altering.

5 Re-install wear plate into gear pockets over the gears with seal and backup gasket up. (Same orientation as removed)

6 Front plate disassembly and assembly:

- Thread 3/8 UNC threaded bolt into *plug cavity*. Start with fingers, then place bolt head in vise and turn front plate to engage threads 2-3 turns.
- Holding bolt in vise, tap front plate with rubber hammer to disengage *plug*.
- Remove *plug* from bolt.
- Install plug in the other casting cavity and tap flush with rubber hammer. Note L or R at bottom of cavity.

7 Hold o-ring in groove of front plate with petroleum jelly. Reassemble front plate over drive shaft end, being careful not to damage shaft seal.

8 Torque 8 cap screws 34 to 38 N•m [25 to 28 lbf•ft].

9 Lubricate gears and mating surfaces with hydraulic oil through ports.

10 Rotate shaft (manually) to ensure proper assembly of components.

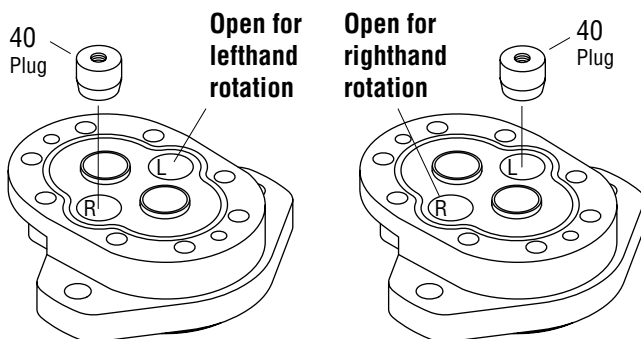
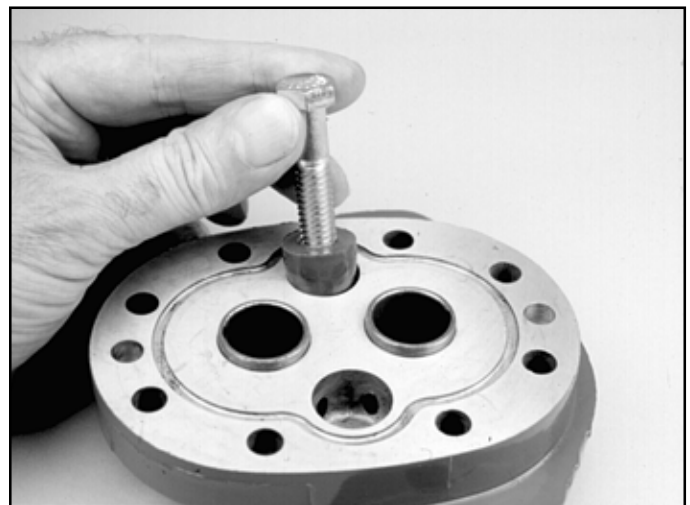

- Ensure that bearing drain holes are free of debris.
- Note proper placement of o-ring in groove of front plate.

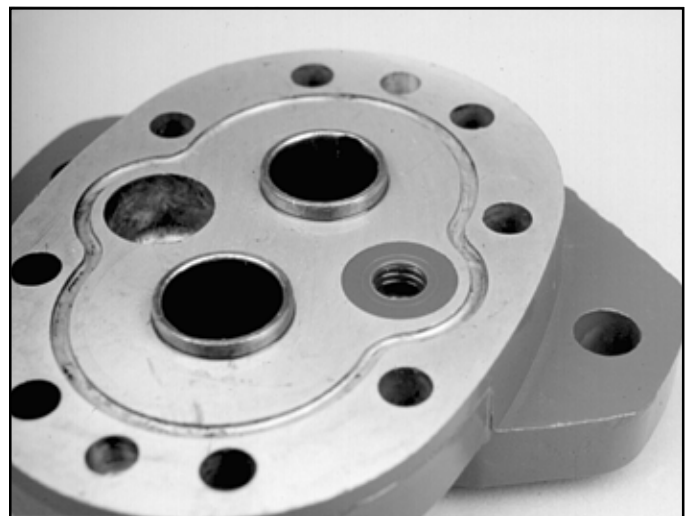

Inspection

Inspect Parts for Wear

General

- 1 Clean and dry all parts.
- 2 Remove all nicks and burrs from all parts with emery cloth.

Gear Assembly Inspection

- 1 Check spline drive shaft for twisted or broken teeth or check keyed drive shaft for broken or chipped keyway.
- 2 Inspect both the drive gear and idler gear shafts at bushing points and seal area for rough surfaces and excessive wear.
- 3 Replace gear assembly if shaft measures less than 19 mm [.748 in] in bushing area. (One gear assembly may be replaced separately; shafts and gears are available as assemblies only.)
- 4 Inspect gear for scoring and excessive wear.
- 5 Replace gear assembly if gear width is below the following dimensions. Refer to chart on this page.
- 6 Assure that snap rings are in grooves on either side of drive and idler gears.
- 7 If edge of gear teeth are sharp, break edge with emery cloth.

Front plate and Backplate Inspection

- 1 Oil groove in bushings in front plate should be in line with dowel pin holes and 180° apart. The oil grooves in the backplate bushings should be at approximately 37° to the pressure side.
- 2 Replace the backplate or front plate if I.D. of bushings exceed 19,2 mm [.755 in] (Bushings are not available as separate items).
- 3 Bushings in front plate should be at 3,20 mm [.126 in] above surface of front plate.
- 4 Check for scoring on face of backplate. Replace if wear exceeds ,038 mm [.0015 in.].

Body Inspection

- 1 Check body inside gear pockets for excessive scoring or wear.
- 2 Replace body if I.D. of gear pockets exceeds 43,7 mm [1.719 in].

Model Number	26001	26002	26003	26004	26005	26006	26007	26008	26009	26010	26011	26012	26013
Pump Disp. cm ³ /r [in ³ /r]	6,6 [.40]	8,2 [.50]	9,5 [.58]	10,8 [.66]	13,8 [.84]	16,7 [1.02]	19,7 [1.20]	22,5 [1.37]	24,3 [1.48]	25,2 [1.54]	27,7 [1.69]	29,0 [1.77]	30,6 [1.87]
Gear Width mm [in]	7,85 [.309]	9,75 [.384]	11,20 [.441]	12,95 [.510]	16,15 [.636]	19,35 [.762]	22,56 [.888]	25,76 [1.014]	28,12 [1.107]	28,96 [1.140]	32,16 [1.266]	33,78 [1.330]	35,36 [1.392]

Reassembly

General Information

It is important that the relationship of the backplate, body, wear plate and front plate is correct. You will note two half moon cavities in the body. Note: The smaller half moon port cavity must be on the pressure side of the pump. The side of wear plate with midsection cut out must be on suction side of pump. Suction side of backplate is always side with larger port boss.

Reassembly

- 1 During the reassembly replace the *wear plate, seal, back-up gasket, shaft seal and o-rings* as new parts.
- 2 Install *o-ring* in groove of front plate.



- 3 Apply a thin coat of petroleum jelly or hydraulic oil to both milled gear pockets of body. Slip body onto front plate with half moon port cavities in body facing away from front plate.

Note: The small half moon port cavity must be on the pressure side (the plugged side of the front plate) of pump.

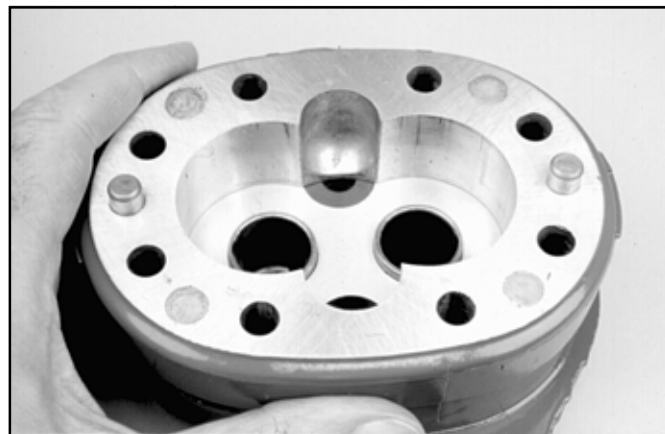

- 4 Install new *seal* and new *backup gasket* into wear plate. Note in the middle of the backup gasket a flat section or support. This area must face away from the wear plate inside the seal.



- 5 Place new *wear plate, seal, and backup gasket* into gear pocket with seal and backup gasket next to front plate. The side of the wear plate with the mid section cut-away must be on the suction side of pump.

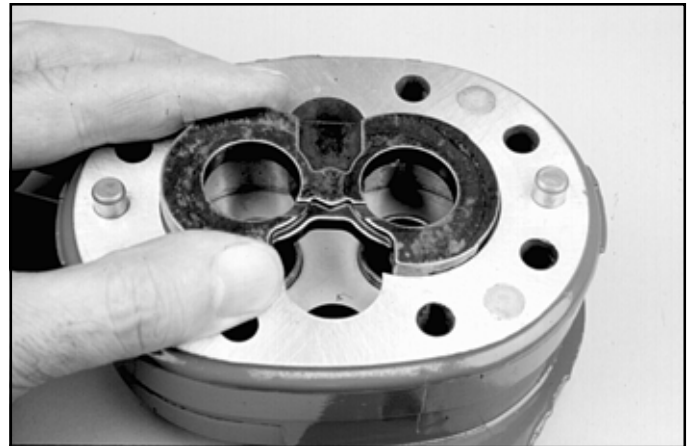

- 6 Dip *gear assemblies* into oil and slip into front plate bushings and gears into pockets of body.



Reassembly

- 7 Install new *o-ring* in groove of backplate.

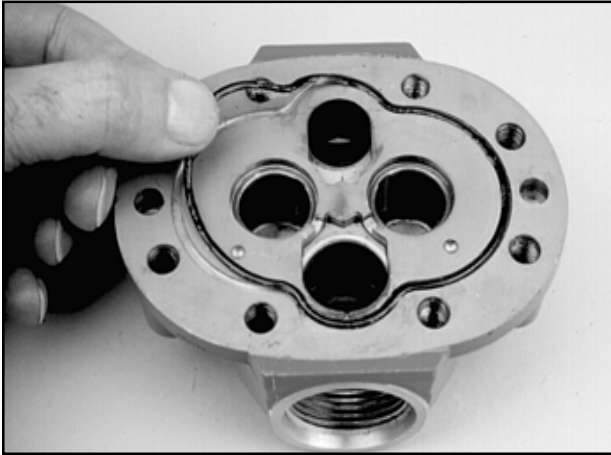

- 8 Make sure port orientation is correct and then slide *backplate* over gear shafts until dowel pins are engaged.
- 9 Secure with *cap screws* and new *washers*. Tighten cap screws evenly in a crisscross pattern 34 to 38 N•m [25 to 28 lbf•ft] torque.
- 10 Place washer over drive shaft into housing. Liberally oil shaft seal and install over drive shaft, carefully so that rubber sealing lips are not cut.



- 11 Place 1-5/16 in. O.D. sleeve over shaft and press in shaft seal until flush with front surface of front plate.
- 13 Install key on keyed shaft.

Note: Refer to Start-up Procedure and Trouble Shooting Procedure.

Specific Backplate Parts List

Relief Valve Backplate

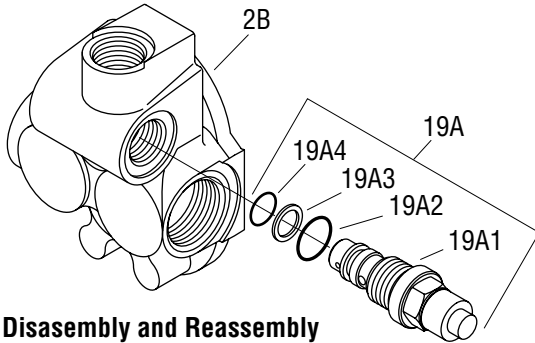

Disassembly and Reassembly

- 1 After removing *relief valve*, remove and replace o-rings and backup ring with new parts.
- 2 Install *relief valve* and torque 41 to 46 N•m [30 to 34 lbf•ft]

Item No.	Description	Qty.
2	Relief Valve Backplate	1
18	O-ring	3
19A	Relief Valve Assembly	1
19A1	Relief Valve	1
~ 19A2	O-ring	1
~ 19A3	Backup Ring	1
~ 19A4	O-ring	1
19B	Plug Assembly	1
19B1	Plug	1

Flow Divider Backplate

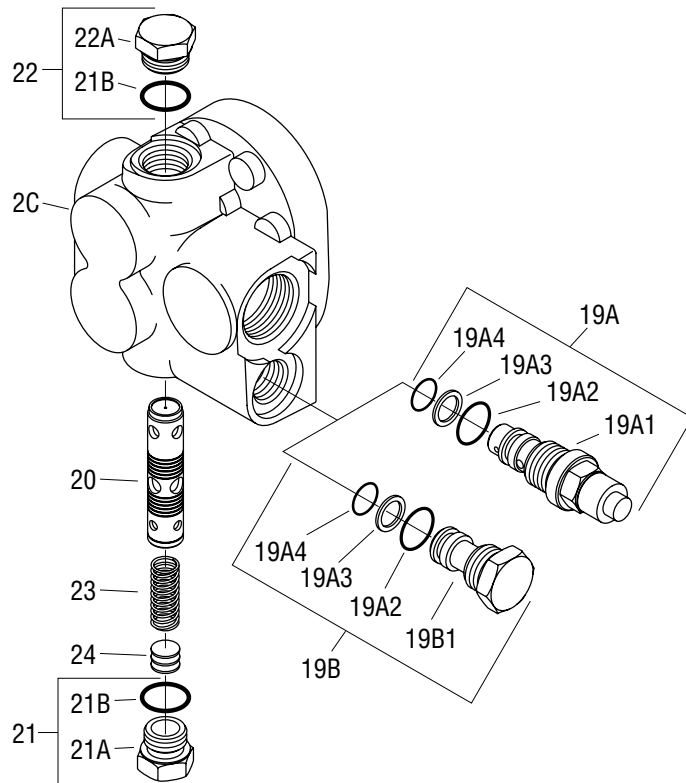

Disassembly and Reassembly

- 1 After removing *relief valve or plug*, remove and replace o-ring and backup ring with new parts.
- 2 Install *relief valve or plug* and torque 41 to 46 N•m [30 to 34 lbf•ft]
- 3 Remove flow divider *plugs, shims, spring, and spool* from backplate. (Notice orientation of spool with cavity in backplate)
- 4 Install new plug *seals* on plugs. Install *spool, spring, shims, and plug assemblies* into backplate. Torque plugs 29 to 33 N•m [21 to 24 lbf•ft]

Item No.	Description	Qty.
2C	Flow Divider Backplate	1
19A	Relief Valve Assembly	1
19A1	Relief Valve	1
~ 19A2	O-ring	1
~ 19A3	Backup Ring	1
~ 19A4	O-ring	1
19B	Plug Assembly	1
19B1	Plug	1
20	Flow Divider Spool	1
21	Plug/O-ring Assembly	1
21A	Plug	1
~ 21B	O-ring	2
22	Plug/O-ring Assembly	1
22A	Plug	1
23	Spring	1
24	Shim (.0239 inch thick)	A/R
A/R	- As Required	

Specific Backplate Parts List

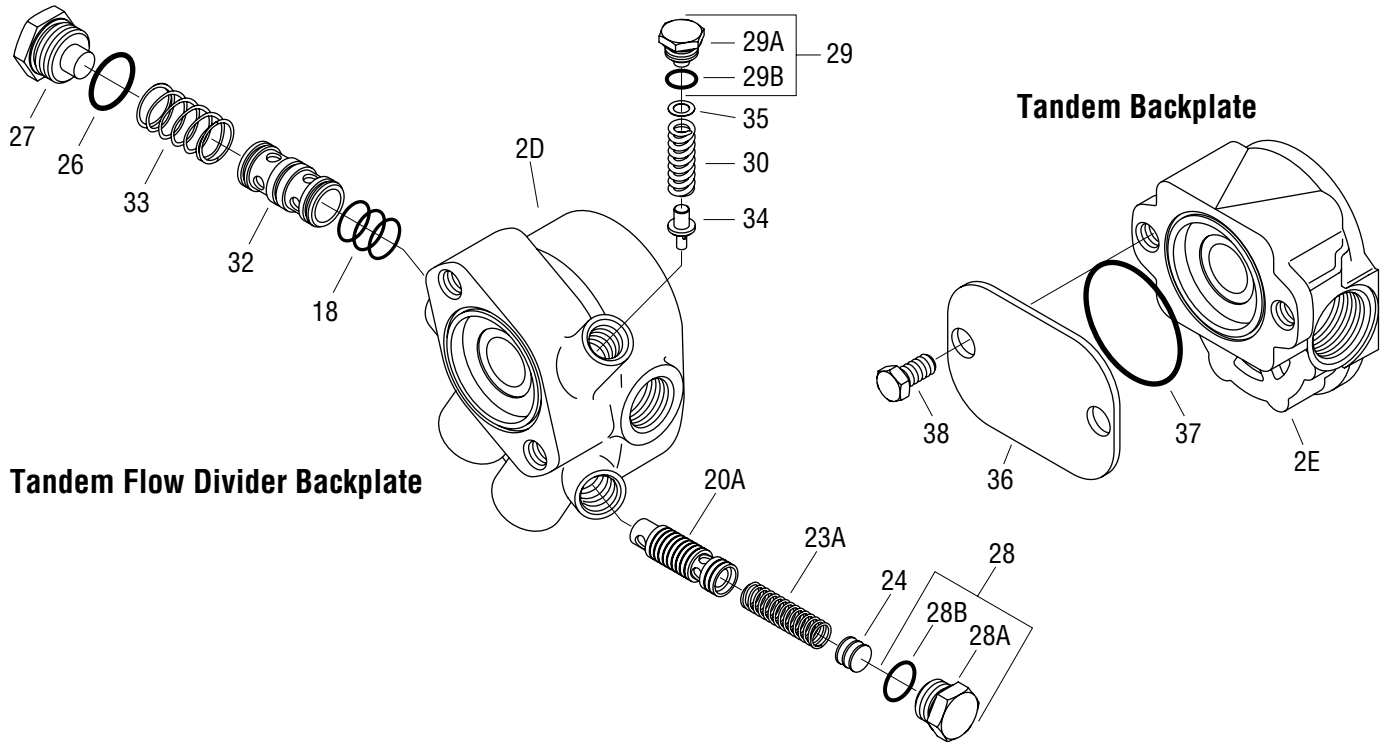

Disassembly and Reassembly

- 1** Remove *relief valve plug, shim, spring, and poppet* from backplate. Do not remove internal relief valve seat. Seat is loctited to a predetermined depth. Remove o-ring from plug and replace with new o-ring.
- 2** Install *poppet, spring, shim, and relief valve plug* and torque 14 to 16 N•m [10 to 12 lbf•ft]
- 3** Remove flow divider *plugs, shims, springs, spool, and sleeve* from backplate. (Notice orientation of spool with cavity in backplate) Remove *o-rings* from sleeve and replace with new *o-rings*.
- 4** Install *sleeve, spool, springs, shims, and plug assemblies* into backplate. Torque plug #27 48 to 54 N•m [35 to 40 lbf•ft] and plug #28 29 to 33 N•m [21 to 24 lbf•ft]

Item No.	Description	Qty.
2D	Tandem Flow Divider Backplate	1
2E	Tandem Backplate	1
18	O-ring	3
20A	Spool for Tandem Flow Divider Backplate	
23A	Spring for Tandem Flow Divider Backplate	1
24	Shim (.0239 inch thick)	A/R
~ 26	O-ring	1
27	Plug	1
28	Plug/O-ring Assembly	1
28A	Plug	1
~ 28B	O-ring	2
29	Plug/O-ring Assembly	1
29A	Plug	1
~ 29B	O-ring	1
30	Relief Valve Spring	1
32	Sleeve	1
33	Spring	1
34	Poppet	1
35	Shim Washer (.010 inch thick)	A/R
36	Tandem Cover Plate	1
37	O-ring	1
38	Cap Screw	2
A/R	- As Required	

Placing Series 26 Gear Pump Back into Operation

When test stand is *available*.

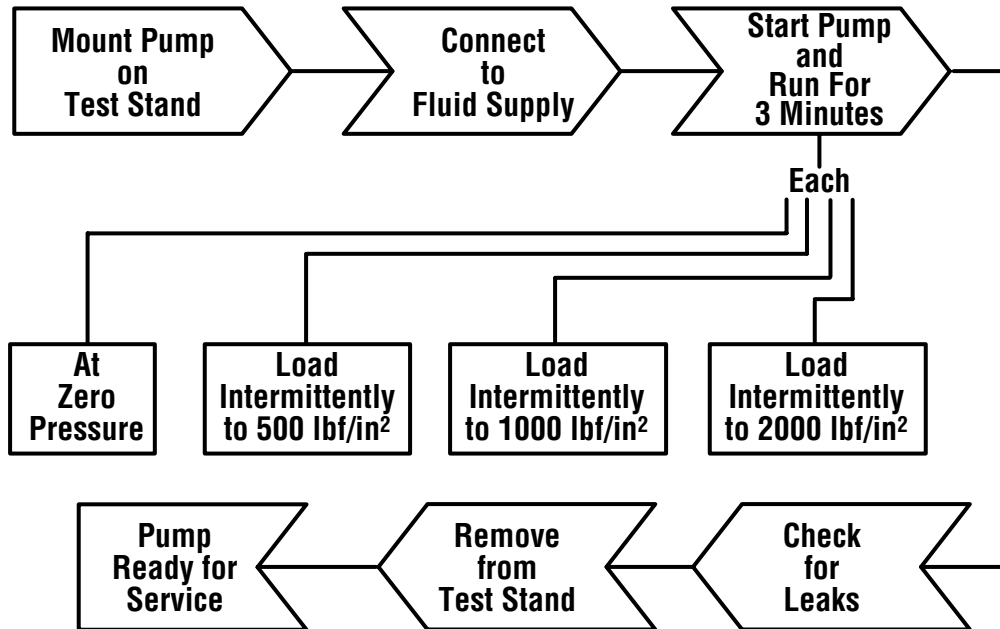

When test stand is *not available*.

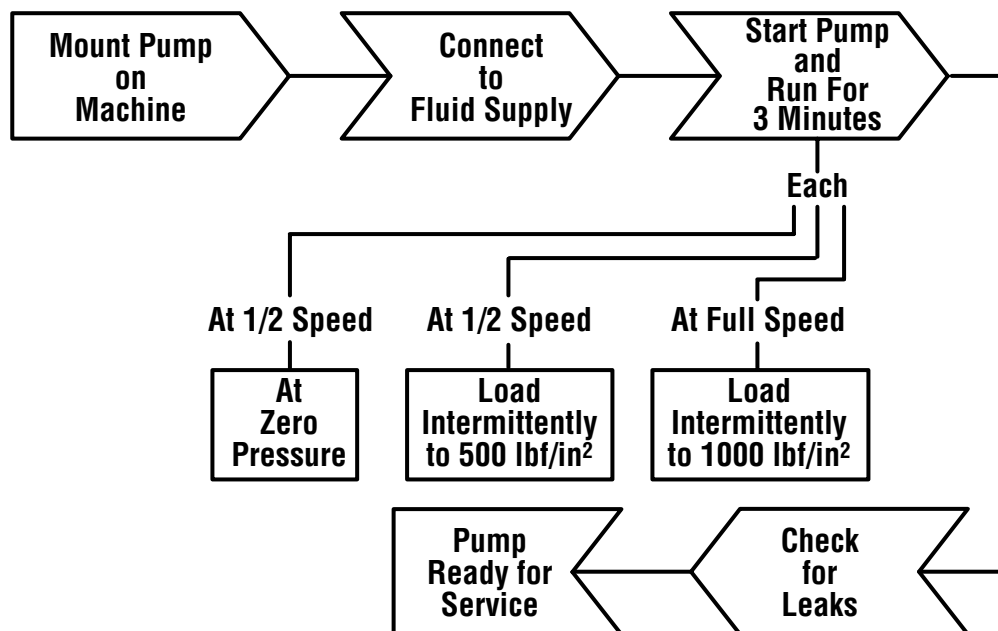

Trouble Shooting

Problem	Possible Cause	Correction
Cavitation	<ul style="list-style-type: none"> a. Oil too heavy. b. Oil filter plugged. c. Suction line plugged or too small. 	<ul style="list-style-type: none"> a. Change to proper viscosity b. Clean filter. c. Clean line and check size of line.
Oil heating	<ul style="list-style-type: none"> a. Oil supply low. b. Contaminated oil. c. Setting of relief valve too high or too low. d. Oil in system too light. 	<ul style="list-style-type: none"> a. Fill reservoir. b. Drain reservoir and refill with clean oil. c. Set to correct pressure. d. Drain reservoir and refill with proper viscosity oil.
Shaft seal leakage	<ul style="list-style-type: none"> a. Worn shaft seal. b. Worn shaft in seal area. c. Debris in shaft seal suction side drain holes. 	<ul style="list-style-type: none"> a. Replace shaft seal. b. Replace drive assembly. c. Disassemble pump and inspect.
Foaming oil	<ul style="list-style-type: none"> a. Low oil level b. Air leaking into suction line c. Wrong kind of oil. 	<ul style="list-style-type: none"> a. Fill reservoir. b. Tighten fittings. c. Drain and fill reservoir with non-foaming oil.

Note

Wear Plate Identification

A product improvement has been made to the Model 26000 gear pump with a new designed wear plate. To identify the new wear plate, look for grooves placed in the seal side of the wear plate as shown below.

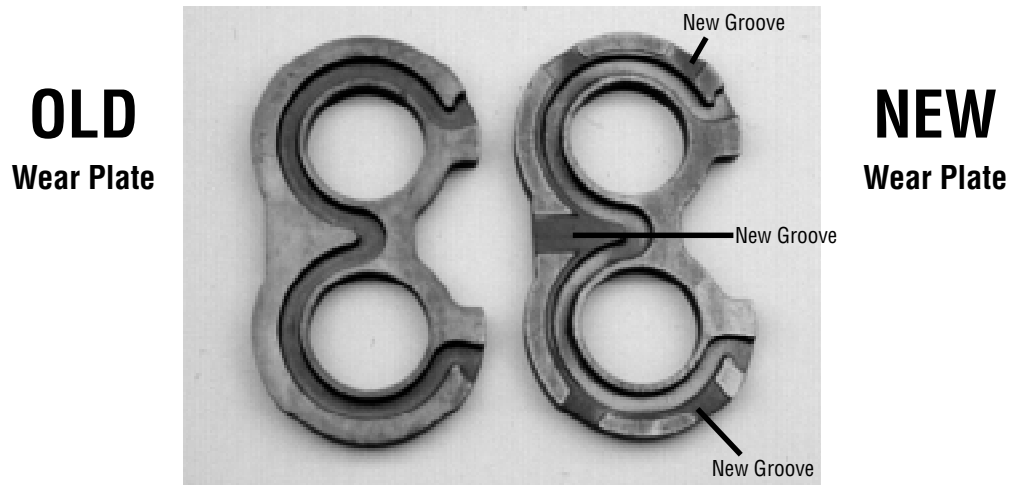

This new wear plate enables better pressure clamping with aerated oil in pumps 1.37 cubic inch or smaller. Aerated oil may occur during a cold start-up in applications with long suction lines or when the mouth of the inlet line is temporarily exposed to air.

**Order parts from 6-634 Parts Information booklet.
Each order must include the following information.**

1. Product and/or Part Number
2. Serial Number Code
3. Part Name
4. Quantity

Eaton Corporation
Hydraulics Division
15151 Hwy. 5
Eden Prairie, MN 55344
Telephone 612/937-9800
Fax 612/937-7130

Eaton Ltd.
Hydraulics Division
Glenrothes, Fife
Scotland, KY7 4NW
Telephone 01-592-771-771
Fax 01-592-773-184

Eaton GmbH
Hydraulics Products
Am Schimmersfeld 7
40880 Ratingen, Germany
Telephone 02102-406-830
Fax 02102-406-800



Quality System Certified
Products in this catalog are manufactured
in an ISO-9001-certified site.

CONTENTS

INTRODUCTION Page 6-3
 COOLING SYSTEM 6-4
 ENGINE OIL 6-5
 ENGINE OIL FILTER 6-5
BELTS 6-5
 ENGINE BELT 6-5
 AIR FILTER 6-6
 AIR FILTER INDICATOR 6-6
 FUEL FILTER/WATER SEPARATOR 6-7
 TO REPLACE FUEL FILTER/WATER
 SEPARATOR 6-7
 FUEL LINES 6-9
 FUEL PUMP 6-9
 PRIMING FUEL SYSTEM 6-10
 TO PRIME FUEL SYSTEM 6-10
 TO REMOVE ENGINE 6-11
 TO INSTALL ENGINE 6-14
ENGINE SPEEDS 6-16

DIESEL ENGINE SERVICE MANUAL
KUBOTA D1105 B (E)
TENNANT Part Number 84660

INTRODUCTION

This section includes repair information on the engine and related systems, such as fuel, electrical, and drive belts. Also, engine removal and installation.

ENGINE-DIESEL

COOLING SYSTEM

Check the radiator coolant level daily in the overflow reservoir. Use clean water mixed with a permanent-type, ethylene glycol antifreeze to a -34°C (-30°F) rating. Add coolant to the overflow reservoir.

FOR SAFETY: When Servicing Machine, Avoid Contact With Hot Engine Coolant.

Check the radiator hoses and clamps every 200 hours of operation. Tighten the clamps if they are loose. Replace the hoses and clamps if the hoses are cracked, harden, or swollen.

Check the radiator core exterior and hydraulic cooler fins for debris daily. Blow or rinse all dust, which may have collected on the radiator, in through the radiator fins, and out the grill, opposite the direction of normal air flow. Be careful not to bend the cooling fins when cleaning. Clean thoroughly to prevent the fins becoming encrusted with dust. Clean the radiator and cooler only after the radiator has cooled to avoid cracking.

FOR SAFETY: When Servicing Machine, Wear Eye And Ear Protection When Using Pressurized Air Or Water.

Flush the radiator and the cooling system every 1600 hours of operation, using a dependable cleaning compound.

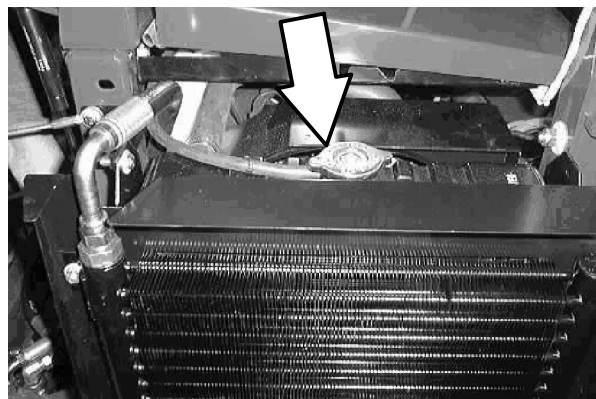

ENGINE OIL

Check the engine oil level daily. The engine oil dipstick can be accessed by lifting up the engine cover. Change the engine oil and oil filter after every 100 hours of machine operation. Use 10W30 SAE-CD/SE rated engine oil.

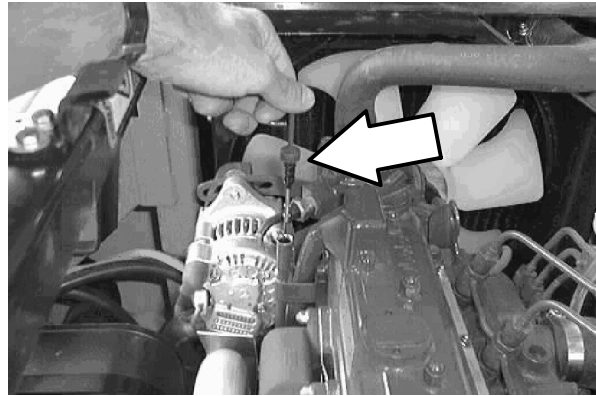
**ENGINE OIL FILTER**

Open the seat support assembly. Locate the engine oil filter to the right of the machine battery. Change the engine oil and oil filter after every 100 hours of machine operation. Use 10W30 SAE-CD/SE rated engine oil.

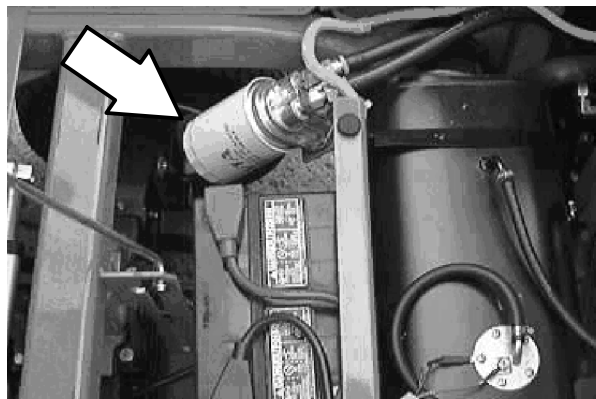

BELTS

ENGINE BELT

The engine fan belt is driven by the engine crankshaft pulley and drives the alternator pulley. Proper belt tension is 10 mm (0.40 in) from a force of 4 to 5 kg (8 to 10 lb) applied at the mid-point of the longest span.

Check and adjust the belt tension every 100 hours of operation.

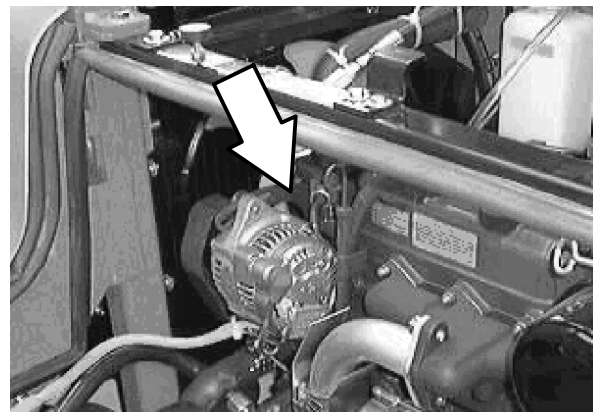

AIR FILTER

The engine air filter housing has a dust cap and a dry cartridge-type air filter element. Empty the dust cap daily. Check the dust cap every 100 hours of operation to make sure it is expelling dust. Replace the dust cap if the rubber is worn.

The air filter element must be replaced whenever it is damaged or has been cleaned three times.

Service the air filter element only when the *air filter indicator* shows restriction in the air intake system. Do not remove the air filter element from the housing unless it is restricting air flow.

To clean the filter element, remove it from the filter housing. Carefully clean the end cap and the interior of the housing with a damp cloth. Clean the housing sealing surfaces.

Using an air hose, direct clean, dry air, maximum 205 kPa (30 psi), up and down the pleats on the inside of the element. Do not rap, tap or pound dust out of the element.

FOR SAFETY: When Servicing Machine, Wear Eye And Ear Protection When Using Pressurized Air Or Water.

After cleaning the air filter element, inspect it for damage by placing a bright light inside. The slightest rupture requires replacement of the element. Inspect the seals on the ends of the element, they should be flexible and undamaged.

Install the dust cap on the air filter housing with the arrows pointing up.

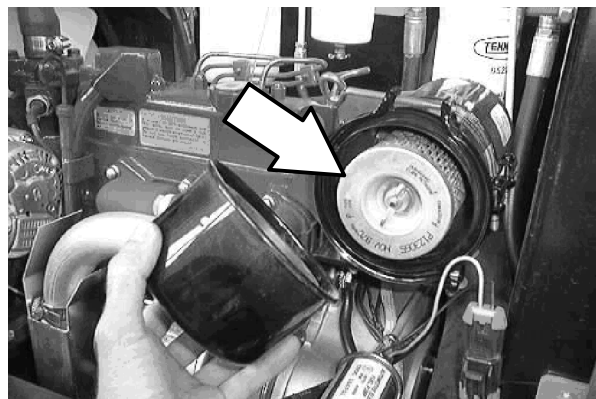
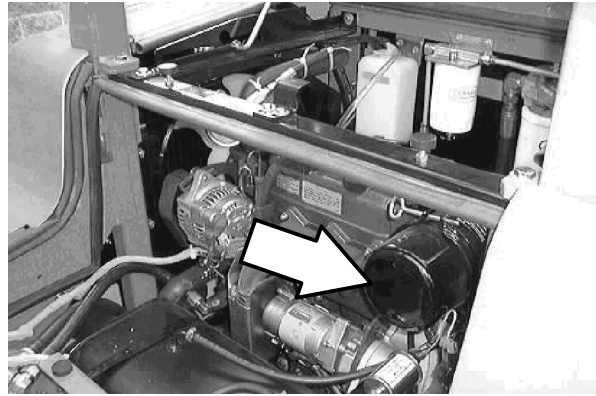

AIR FILTER INDICATOR

The air filter indicator shows when to clean or replace the air filter element. Check the indicator daily. The indicator's red line will move as the air filter element fills with dirt. Do not clean or replace the air filter element until the red line reaches 5 kPa (20 in H₂O) and the "SERVICE WHEN RED" window is filled with red. The indicator's red line may return to a lower reading on the scale when the engine shuts off. The red line will return to a correct reading after the engine runs for a while.

Reset the air filter indicator by pushing the reset button on the end of the indicator after cleaning or replacing the air filter element.

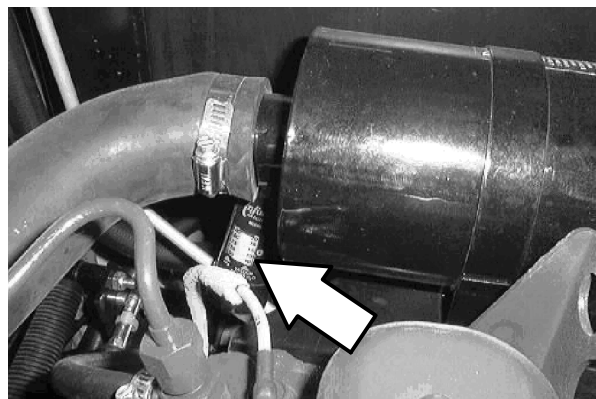

FUEL FILTER/WATER SEPARATOR

The fuel filter/water separator cartridge filters impurities from the diesel fuel. It is located on the back side of the engine, to the right of the larger hydraulic fluid filter.

Replace the fuel filter element every 200 hours of operation.

NOTE: Check the fuel filter water trap daily for water. Drain any water that has collected in the cartridge.

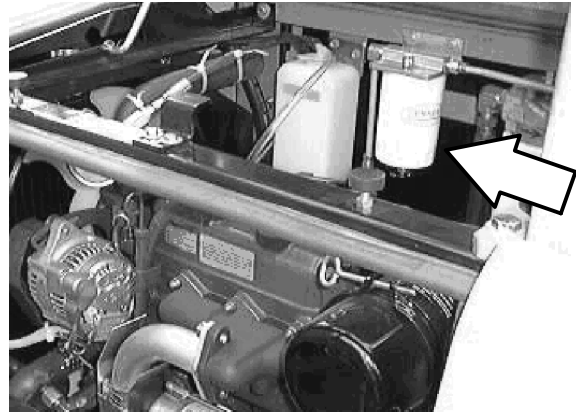

TO REPLACE FUEL FILTER/WATER SEPARATOR

FOR SAFETY: Before Leaving Or Servicing Machine; Stop On Level Surface, Set Parking Brake, And Turn Off Machine.

1. Open the hopper cover and tilt the hopper back.
2. Open the top engine cover.
3. Remove the five pan screws holding the rear engine cover to the machine. Remove the cover.
4. Locate the fuel filter/water separator in the center of the upper machine frame. Remove the air cleaner hose from the engine and air cleaner. Place a drain pan under the filter.
5. Open the pet-cock on the bottom of the filter cartridge. Let any water drain from the filter.
6. Un-screw the filter from the filter head. Properly discard the old filter.
7. Place a small amount of oil on the rubber O-ring on the new filter.
8. Screw the new filter onto the filter head. Tighten until snug then 1/4 turn.

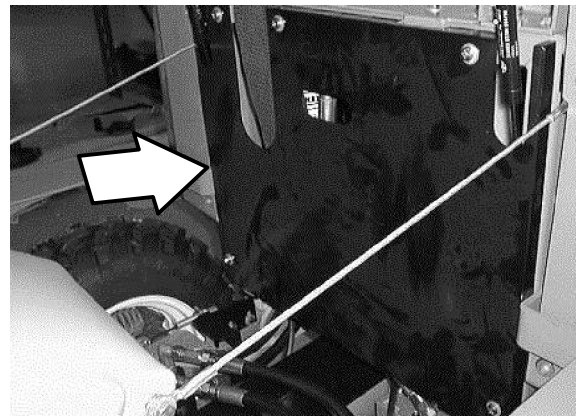
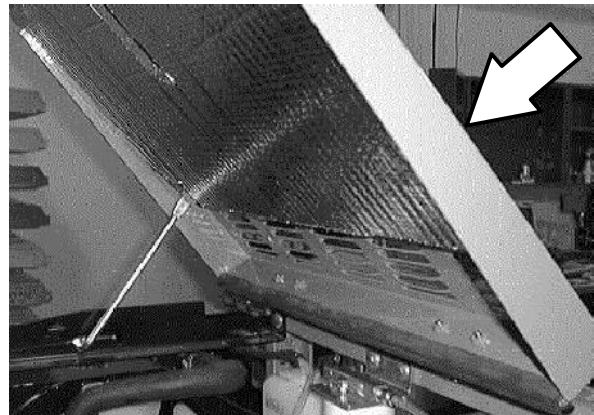

ENGINE-DIESEL

9. Open the air breather on top of the filter head and turn the engine over. Close the air breather when the diesel fuel coming out of the breather is free of air bubbles. **The engine may start at any time during this procedure.** *Clean up any spilled diesel fuel.*
10. Remove the drain pan. Reinstall the rear engine cover.
11. Tilt the hopper forward and close the hopper cover.
12. Start the machine and check the new filter for any leaks.

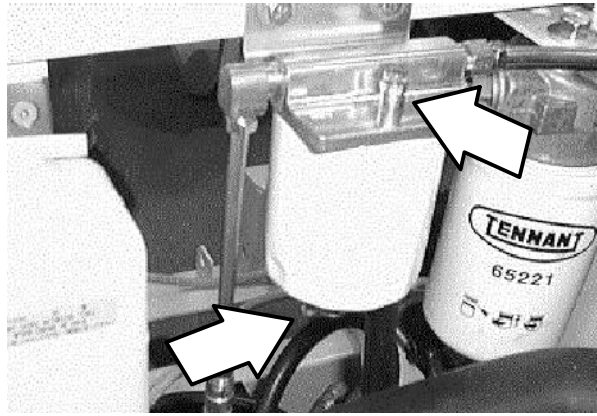

FUEL LINES

Check the fuel lines every 50 hours of operation. If the clamp band is loose, apply oil to the screw of the band, and securely tighten the band.

Parts of the fuel line are made of rubber. The fuel lines may become worn out whether the engine has been used much or not. Replace the rubber fuel lines and clamp bands every two years.

If the fuel lines and clamp bands are found worn or damaged before two years' time, replace or repair them at once. Bleed the fuel system after replacement of any of the fuel lines, see TO PRIME THE FUEL SYSTEM. When the fuel lines are not installed, plug both ends with clean cloth or paper to prevent dirt from entering the lines. Dirt in the lines can cause fuel injection pump malfunction.

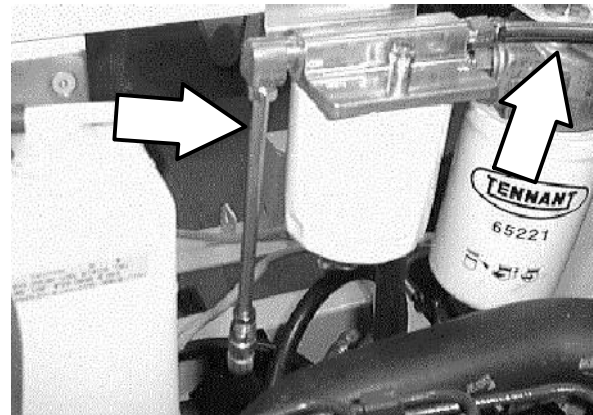
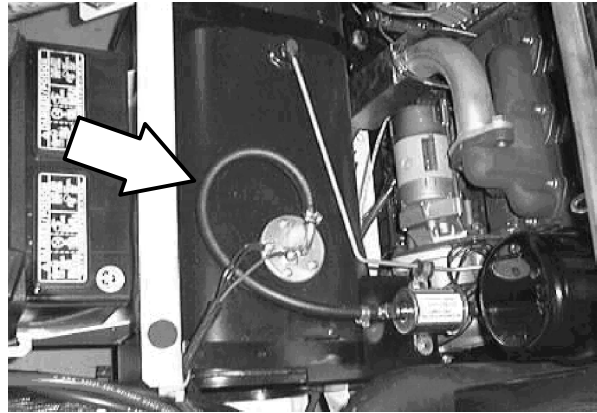
**FUEL PUMP**

Check the fuel pump every 100 hours of operation.

Check the clamps and fuel lines that connect to the fuel pump every 50 hours of operation.

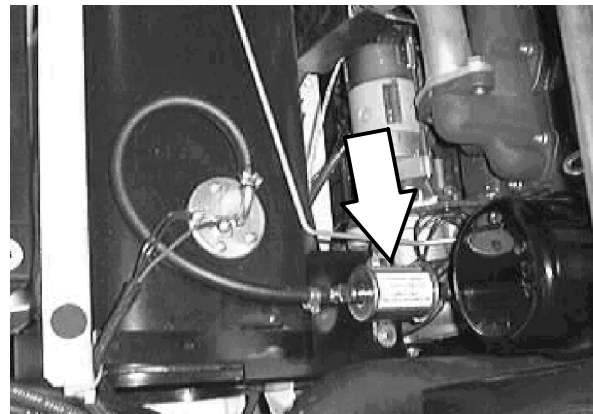

ENGINE-DIESEL

PRIMING FUEL SYSTEM

Priming the fuel system removes pockets of air in the fuel lines and fuel components. Air in the fuel system will prevent smooth engine operation.

Prime the fuel system after running out of fuel, changing the fuel filter, disconnecting the low pressure fuel lines, or any part of the low pressure fuel system leaks during engine operation.

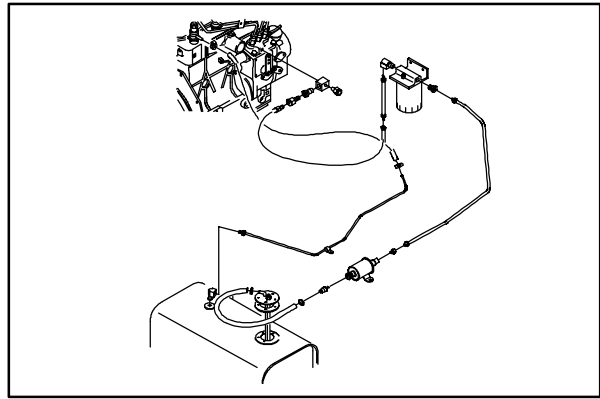

TO PRIME FUEL SYSTEM

FOR SAFETY: Before Leaving Or Servicing Machine; Stop On Level Surface, Set Parking Brake, And Turn Off Machine.

1. Open the seat support and engage the prop rod. Make sure the fuel tank is full.
2. Open the breather vent on top of the fuel filter/water separator.
3. Turn the key to the start position until fuel, free from air, appears at the filter vent point. Close the breather vent.
4. Loosen the bleed screw at the banjo fitting on the injector pump.
5. Turn the key to the start position until fuel, free from air, appears at the banjo fitting on the injector pump. Tighten the connection.
6. Clean up any spilled fuel. Operate the machine and check for proper operation.

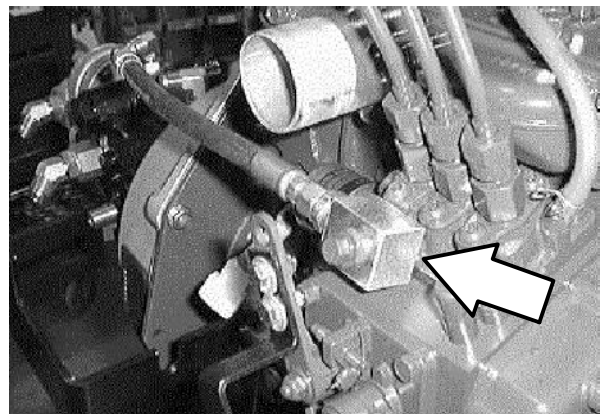
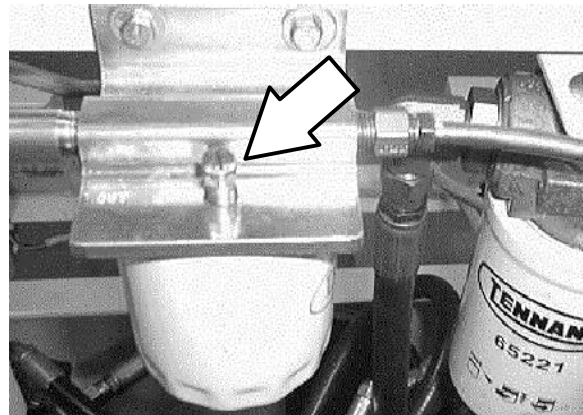

TO REMOVE ENGINE

FOR SAFETY: Before Leaving Or Servicing Machine; Stop On Level Surface, Set Parking Brake, And Turn Off Machine.

1. Open the hopper cover and tilt the hopper back. Close the hopper cover.
2. Open the top engine cover.
3. Remove the five pan screws holding the rear engine cover to the machine. Remove the cover.
4. Pivot the seat assembly forward and engage the prop rod.
5. Disconnect the battery cables.
6. Remove both side fenders.
7. Remove the top engine cover and prop rod at the hinges.
8. Remove the engine cover prop rod cross brace.
9. Remove the black cross brace running between the legs of the roll bar.
10. Remove the clamps holding the two air hoses of the air cleaner assembly to the engine and intake tube. Remove the two air cleaner hoses.
11. Remove the two M10 hex screws holding the air cleaner mounting bracket to the bellhousing. Remove the air cleaner assembly from the machine.
12. Drain the anti-freeze from the cooling system. Remove the radiator hoses from the engine. Disconnect the hose leading to the overflow tank.
13. Remove the four M10 hex screws holding the bottom of the radiator/cooler/shroud assembly to the machine frame.

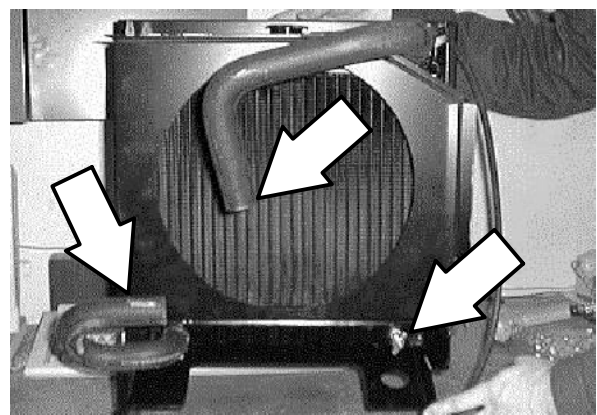
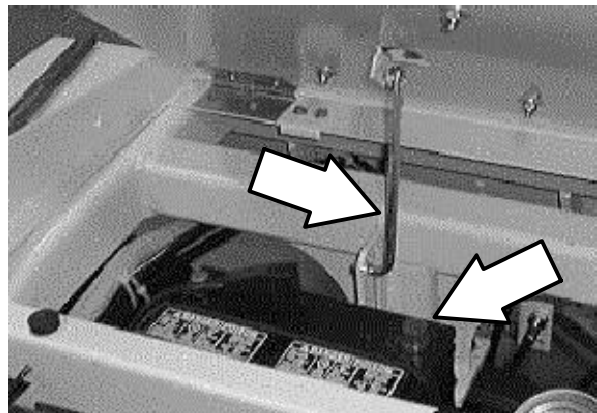
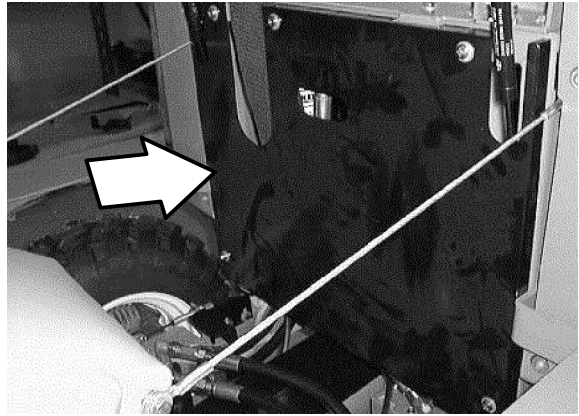

ENGINE-DIESEL

14. Remove the two M8 hex screws holding the top of the radiator to the two "L" brackets. Move the radiator/cooler/shroud assembly away from the front of the engine. Leave the hydraulic hoses connected to the cooler and engine oil cooler lines connected to the lower cooler.
15. Remove the four M6 hex screws holding the fan blade to the engine. Remove the fan from the engine.
16. Disconnect the exhaust pipe at the exhaust manifold.
17. Remove all of the fuel lines (rubber and steel).
18. Remove the fuel filter/water separator from the machine frame.
19. Remove the hardware holding the hydraulic fluid filter to the machine frame. Move the filter and filter head out of the way.

NOTE: Leave the hoses connected to the filter.

20. Pull the radiator overflow tank off the mount bracket.
21. Disconnect the battery cables from the engine starter and the ground cables from the frame
22. Disconnect the main electrical harness from the back of the alternator, starter, oil sender, temp sender, glow plugs, ect. Pull the main harness away from the engine.
23. Disconnect the engine throttle cable at the engine lever. Loosen the throttle cable clamp mount screw. Remove the throttle cable from the mount clamp.
24. Drain the engine oil.

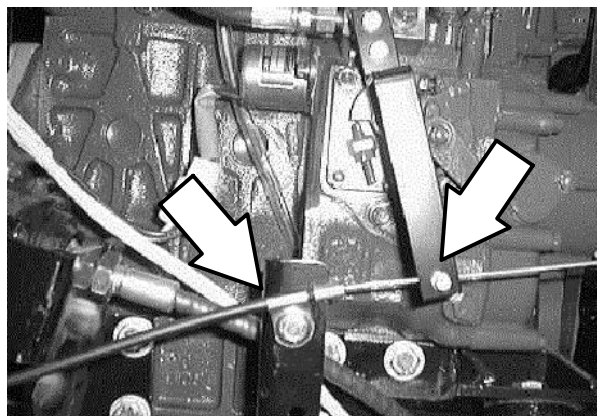
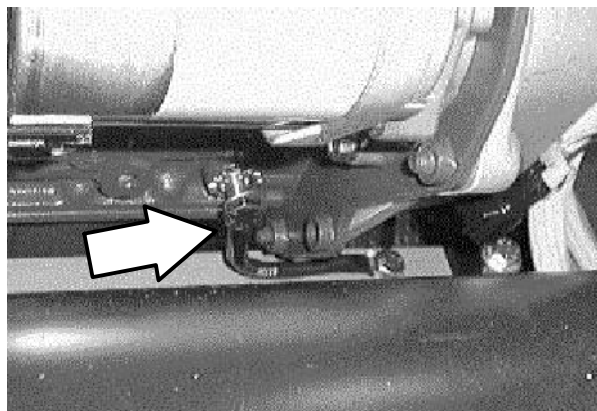
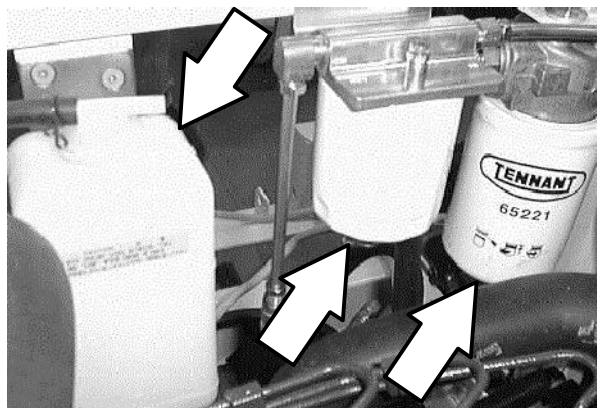
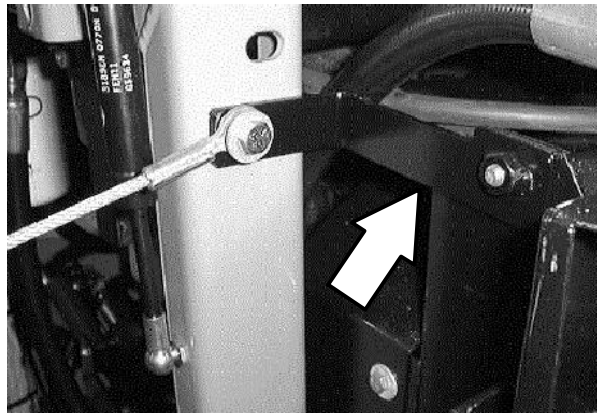

25. Mark, disconnect, and plug the two remote engine oil lines at the oil filter adaptor plate on the engine.

NOTE: Make sure to mark the hoses for proper re-assembly ! If the hoses are connected incorrectly--engine damage may result !

26. Remove the hardware holding the directional hydroback mount bracket to the side of the engine.
27. Remove the two hex screws holding the directional pump arm to the propel pump hub. Pull the directional hydroback assembly away from the engine.
28. Remove the propel pump and accessory pump assembly from the back of the engine. See TO REPLACE PROPEL PUMP instructions in the HYDRAULIC section of this manual. **DO NOT DISCONNECT THE HYDRAULIC HOSES.** Pull the pump back and out of the way for engine removal.
29. Remove the three M12 hex screws, nyloc nuts, and washers holding the engine motor mounts to the engine frame.
30. Using a overhead hoist, hook a chain in the engine lift brackets and slowly lift the engine out of the engine frame. Be careful not to catch the engine on any hydraulic hoses or electrical wires on the way out of the engine compartment.

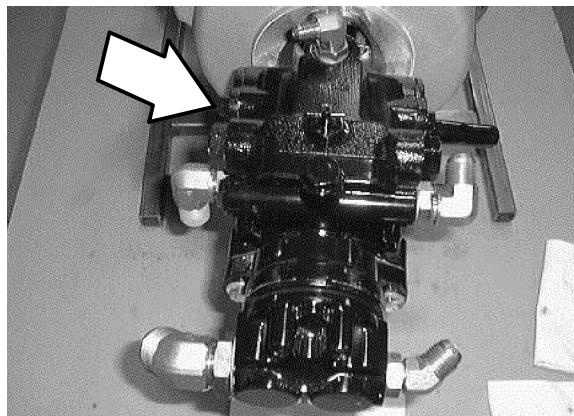
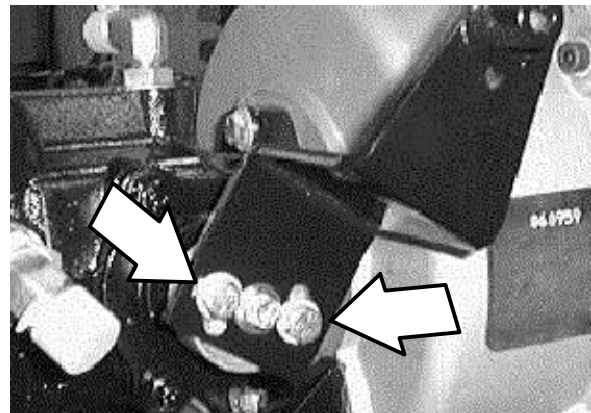
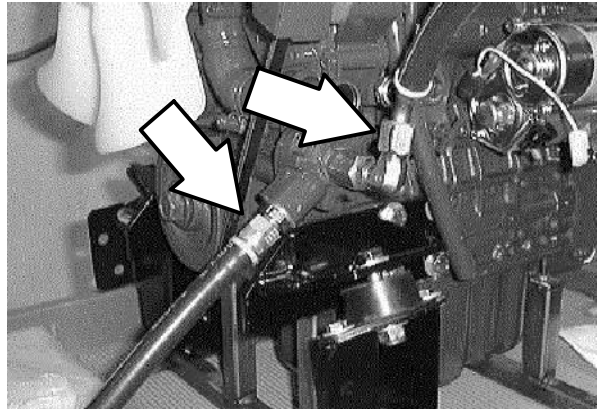

TO INSTALL ENGINE

FOR SAFETY: Before Leaving Or Servicing Machine; Stop On Level Surface, Set Parking Brake, And Turn Off Machine.

1. Using a overhead hoist, hook a chain in the engine lift brackets and slowly lift the engine into the machine frame. Be careful not to catch the engine on any hydraulic hoses or electrical wires on the way into the engine compartment.
2. Line up the three engine isolators in the engine motor mounts with the holes in the frame mounts. Make sure the four special washers are in place between the frame and isolator.
3. Install the three M12 hex screws, washers, and nyloc nuts into the engine mounts. Tighten to 64 - 83 Nm (50 - 60 ft lb).
4. Position the propel/accessory pump assembly back in the bellhousing and drive coupling. See TO REPLACE PROPEL PUMP instructions in the HYDRAULIC section of this manual. Make sure the splines on the pump drive hub line up with the splines in the flywheel drive flange. Install the two hex screws and washers holding the pump assembly to the bellhousing. Tighten to 45 - 58 Nm (36 - 47 ft lb).
5. Reinstall the propel pump arm onto the hub on the side of the propel pump. Reinstall the two hex screws. Leave loose for now.
6. Reinstall the propel hydroback mount bracket onto the side of the engine. Reinstall the two hex screws and tighten to 37 - 48 Nm (26 - 34 ft lb).
7. Reconnect the throttle cable to the engine throttle lever. Tighten the cable clamp.
8. Reconnect the electrical harness to the engine and related component (alternator, starter, oil sender, temp sender, glow plugs, ect.). See harness diagram or electrical schematic in the ELECTRICAL section of this manual.

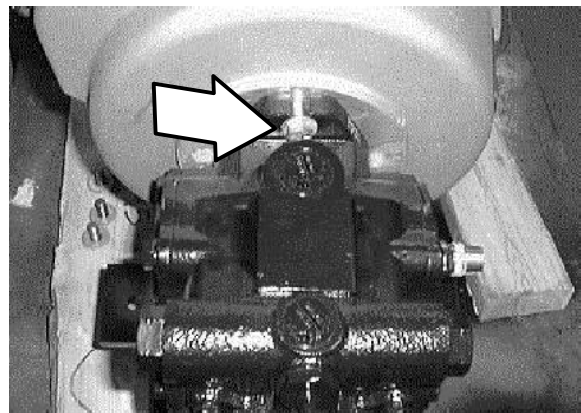
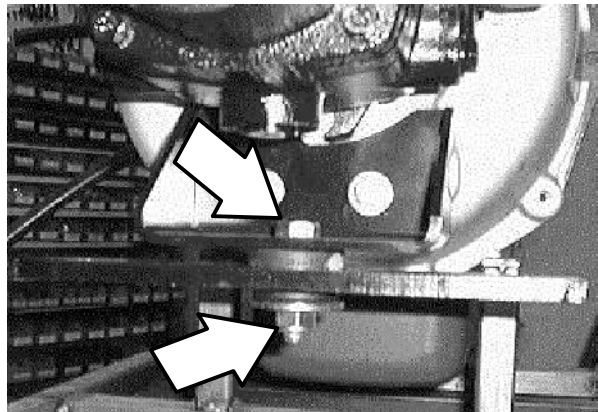
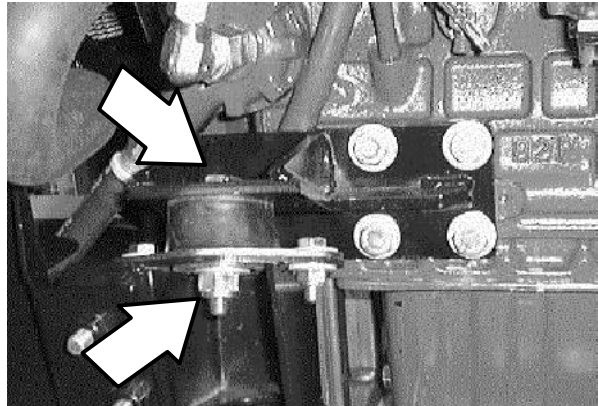
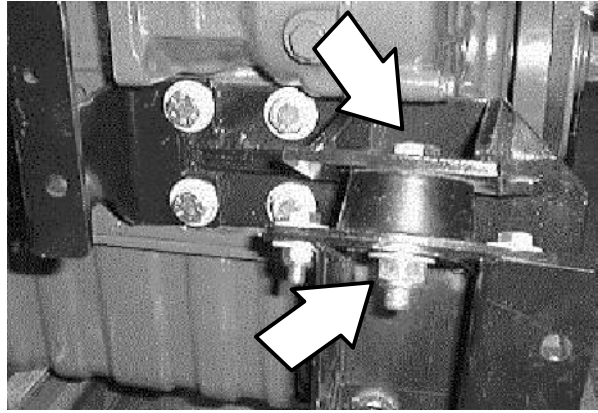

9. Reconnect the battery cables to the starter and the ground cables to the machine frame.
10. Reinstall the radiator over flow tank into the mount bracket.
11. Reinstall the hydraulic fluid filter and head assembly onto the machine frame. Reinstall the two hex screws and tighten to 18 - 24 Nm (15 - 20 ft lb).
12. Reinstall the fuel filter/water separator onto the machine frame. Reinstall the two hex screws and tighten to 8 - 10 Nm (6 - 8 ft lb)
13. Reconnect the fuel lines (rubber and steel)
14. Reconnect the exhaust pipe to the exhaust manifold. Tighten the two hex screws to 37 - 48 Nm (26 - 34 ft lb).
15. Position the engine fan back on the upper engine sheave. Install the four M6 hex screws and tighten to 11 - 14 Nm (7 - 10 ft lb).
16. Pivot the radiator back in position and install the two upper hex screws into the "L" brackets. Tighten to 8 - 10 Nm (6 - 8 ft lb)
17. Reinstall the four hex screws into the lower radiator mount brackets. Tighten the screws to 37 - 48 Nm (26 - 34 ft lb).
18. Reinstall the radiator hoses to the engine and fill the cooling system with 4 L (1 gal) of antifreeze.
19. Reconnect the over flow hose from the top of the radiator to the over flow tank.
20. Reconnect the two engine oil lines leading from the remote oil filter to the adaptor on the front, right side of the engine.

NOTE: Make sure to mark the hoses for proper re-assembly! If the hoses are connected incorrectly--engine damage may result!

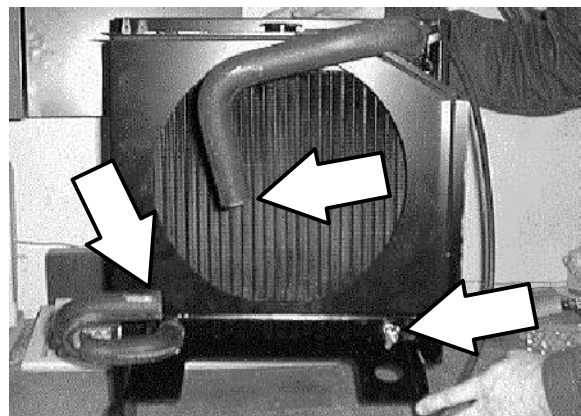
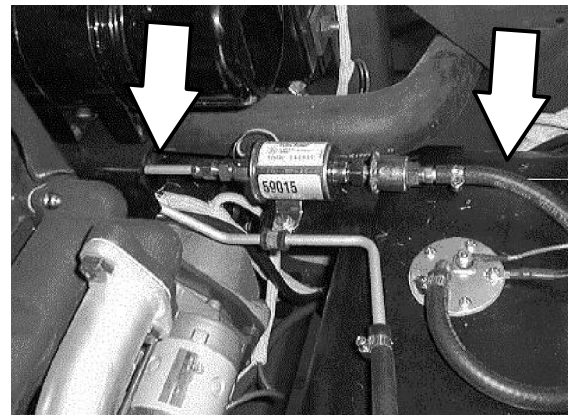
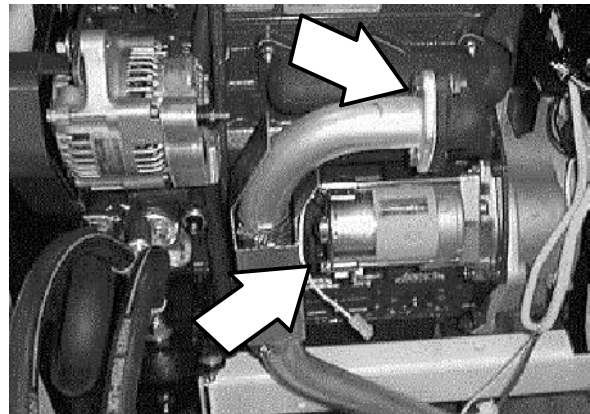
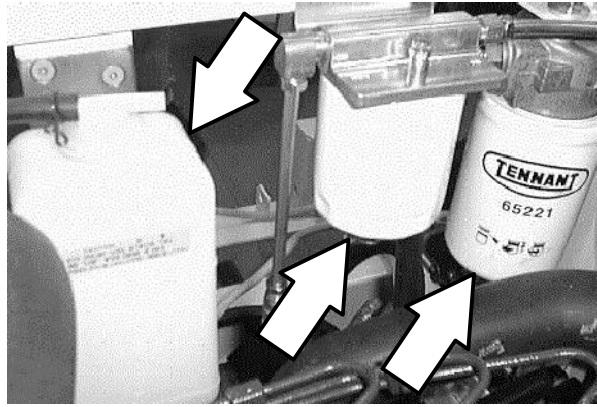

ENGINE-DIESEL

21. Fill the engine with 5.2 L (5.5 qt) 10W30 SAE-CD/SE rated engine oil with a new filter.
22. Reinstall the air cleaner mounting bracket to the rear of the bellhousing. Tighten the two M10 hex screws to 52 - 67 Nm (39 - 51 ft lb).
23. Reinstall the two air cleaner tubes onto the air cleaner and engine intake.
24. Reinstall the black cross brace running between the legs of the roll bar.
25. Reinstall the engine cover prop rod brace.
26. Reinstall the engine cover and prop rod at the hinges.
27. Reinstall both side fenders.
28. Reconnect the battery cables.
29. See TO ADJUST PROPEL NEUTRAL instructions in the CHASSIS section of this manual before attempting to start the machine.
30. Start the machine. *The engine speed and travel speeds must be checked and set at this point.. See below for engine speed setting. See TO SET TRAVEL SPEEDS instructions in the CHASSIS section.*
31. After the engine and travel speeds have been set, close the seat assembly and reinstall the rear engine cover. Tilt the hopper in place and operate the machine. Check all systems carefully for proper operation

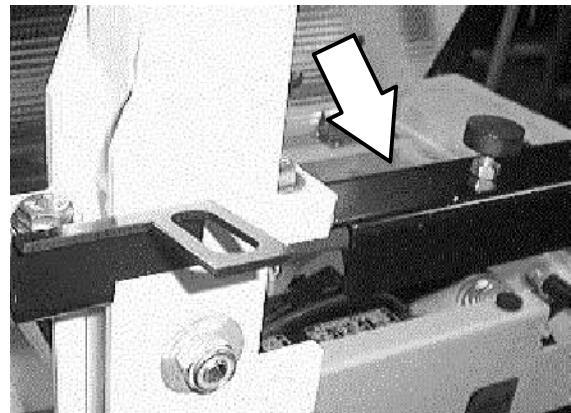
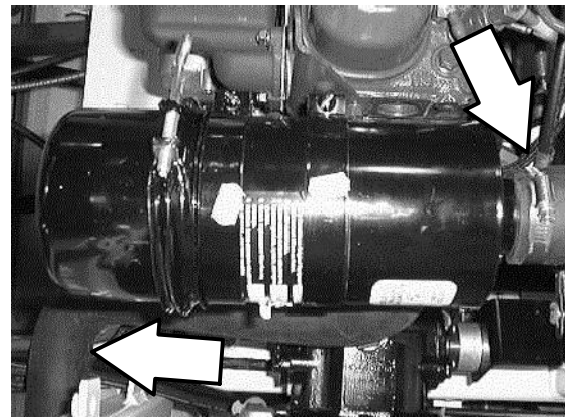
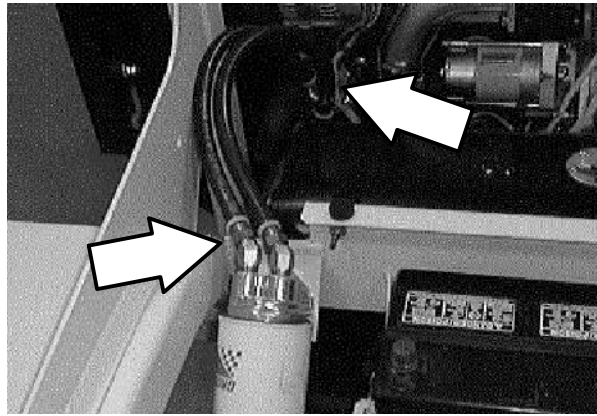

ENGINE SPEEDS

The idle speed of the model ATLV 4300 is set at the factory at 1200 ± 50 rpm. The top engine speed should not exceed 3050 ± 50 rpm. To set the engine speed, use the position of the end of the throttle cable in the cable clamp on the engine bracket to set the upper engine speed. Use the stop bolt on the engine injector pump to set the engine idle speed.

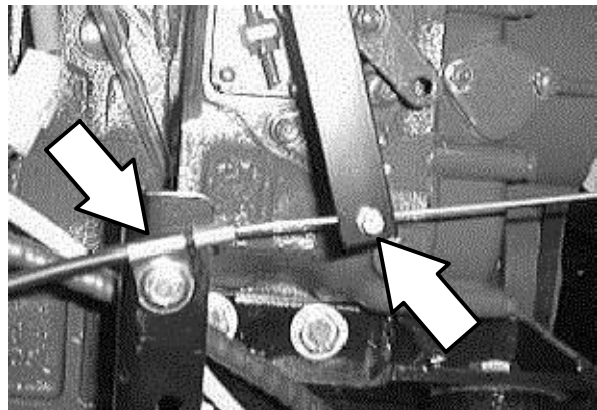



We Need Your Help...

As part of Tennant's Zero Defects Program, we want to know about errors you have found or suggestions you may have regarding our machine manuals. If you find an error or have a suggestion, please complete this postage-paid form and mail it to us. Thank you for helping us make zero defects a way of life at Tennant.

Manual No. _____ Rev. No. _____ Publish Date _____ Page _____

Machine _____ Report Error Suggestion

Name _____ Date _____

Customer Number _____

Company _____

Address _____

City/State/Zip Code _____



TENNANT COMPANY
 Technical Publications #15
 701 North Lilac Drive
 P.O. Box 1452
 Minneapolis, MN 55440-9947

POSTAGE WILL BE PAID BY ADDRESSEE

BUSINESS REPLY MAIL
 FIRST CLASS MAIL PERMIT NO. 94 MINNEAPOLIS, MN



NO POSTAGE
 NECESSARY
 IF MAILED
 IN THE
 UNITED STATES

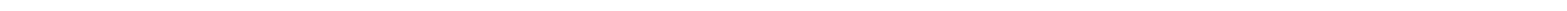
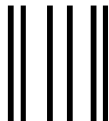

Fold along dotted lines

Tape here

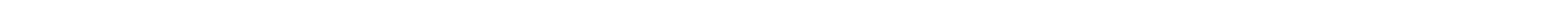



We Need Your Help...

As part of Tennant's Zero Defects Program, we want to know about errors you have found or suggestions you may have regarding our machine manuals. If you find an error or have a suggestion, please complete this postage-paid form and mail it to us. Thank you for helping us make zero defects a way of life at Tennant.

Manual No. _____ Rev. No. _____ Publish Date _____ Page _____

Machine _____ Report Error Suggestion

Name _____ Date _____

Customer Number _____

Company _____

Address _____

City/State/Zip Code _____



TENNANT COMPANY
 Technical Publications #15
 701 North Lilac Drive
 P.O. Box 1452
 Minneapolis, MN 55440-9947

POSTAGE WILL BE PAID BY ADDRESSEE

BUSINESS REPLY MAIL
 FIRST CLASS MAIL PERMIT NO. 94 MINNEAPOLIS, MN



NO POSTAGE
 NECESSARY
 IF MAILED
 IN THE
 UNITED STATES

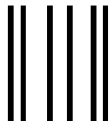

Fold along dotted lines

Tape here

