

PARTS LIST

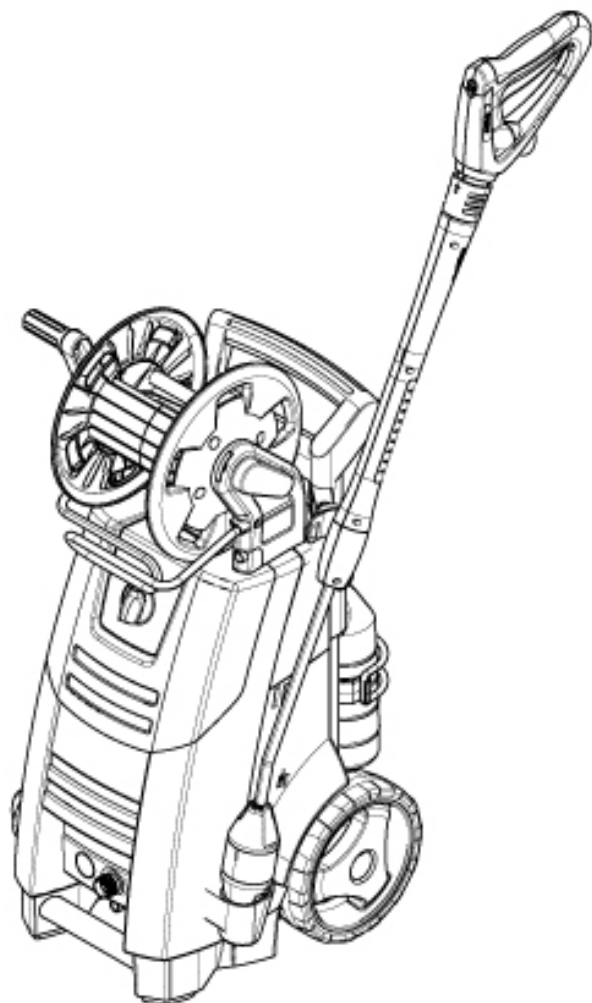

2022.03.30

TABLE OF CONTENTS

Overview front.....	1
Overview back.....	3
Motor pump unit.....	5
Motor pump unit - X.....	7
Hose reel.....	9
Default accessories.....	11

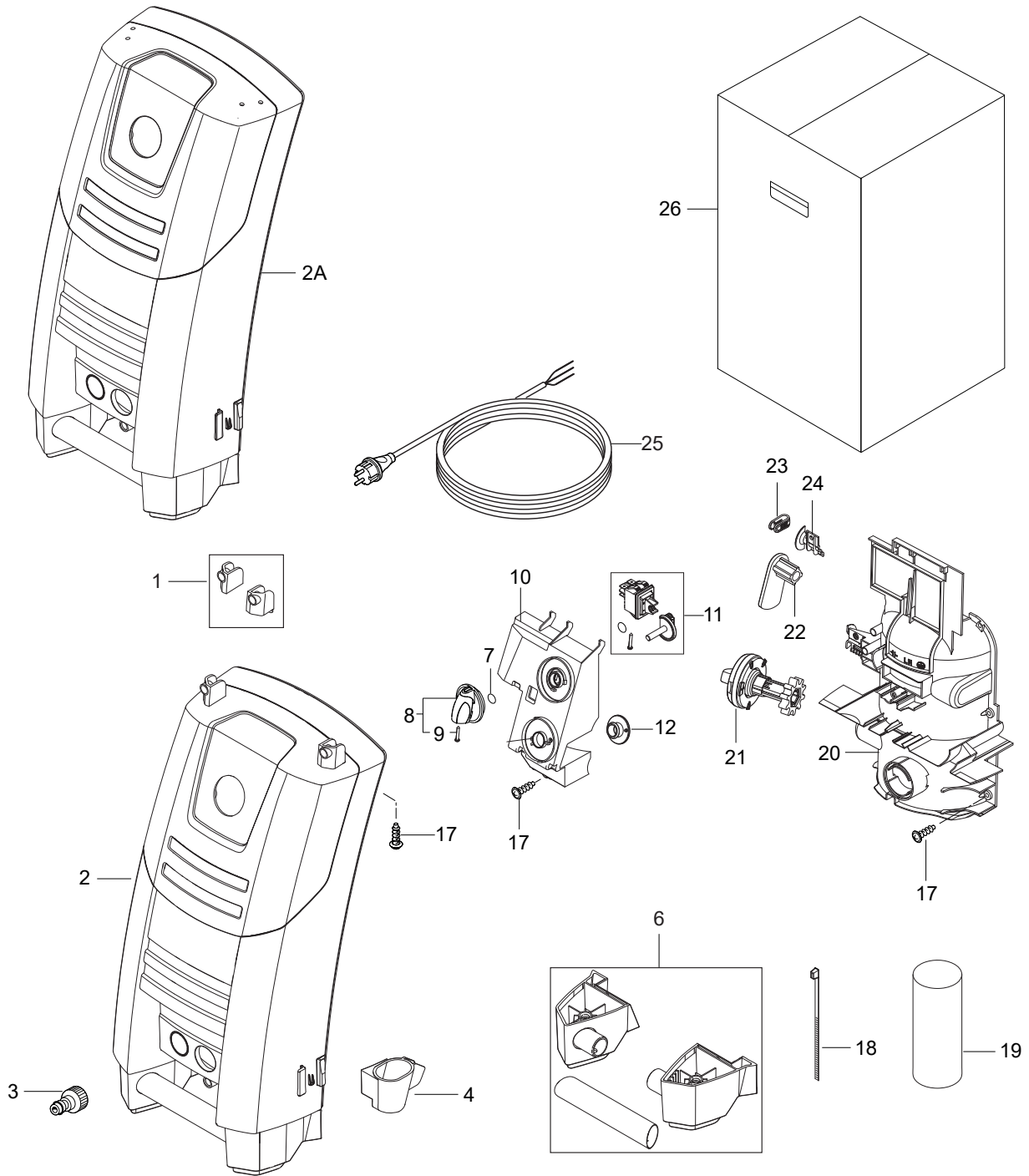

Pos.	Artikel-Nr.	Menge	Variante	Notes
1	128500146	1	Halter	
2	128501668	1	FRONT CABINET KIT WITH HOLE MC 2C	[1]
2A	128501667	1	FRONT CABINET KIT MC 2C	
2A	128471365	1	MC 2C-80/520 T MEX	
3	1402809	1	Schlauchstutzen/Nippel	
4	128500228	1	Doppelstrahlrohrhalterung	
6	128500105	1	Traggriff	
7	9868	1	O-Ring 10x2,5	
8	909100204	1	Drehknopf 6x5 blau	
9	32526	1	Schraube BL- 2,9X19 B	
10	128501271	1	SWITCHBOX SP	
11	128500978	1	PRO MAIN SWITCH KIT	
12	128501672	1	RUBBER PLUG	
17	107141838	10	SCHRAUBE K50X18 WN1451 SCHWARZ TORX 20	
18	1814741	2	Kabelbinder	
19	128500148	1	Kondensator 50 µF 450 V	
20	128501276	1	MOTOR SHIELD FRONT SP	
21	128501673	1	KNOB FLOW REGULATION BLACK	
22	128500155	1	Kabelhaken drehbar	
23	128500122	1	Kabelhalter	
24	128500121	1	Tülle	
25	128500123	1	Anschlussleitung Europa	
25	128500125	1	Anschlussleitung GB	[2]
25	128500896	1	PVC CABLE W.PLUG EU SP	
25	128500899	1	PVC CABLE W.PLUG 5000 GB SP	
25	128500900	1	PVC CABLE W.PLUG AU/NZ SP	
26	128500223	1	BOX POSEIDON2 10Stück SP	

Part Notes:

- [1] - For machines with hose reel
- [2] - STOCK COVERS GUARANTEE

Pos.	Artikel-Nr.	Menge	Variante	Notes
1	128501279	1	CHASSIS BLACK COMPLETE SP	
2	128500128	2	Schiene	
3	128501327	1	SIDE BUMPER LEFT BLACK	
4	128500107	1	Rad. 200 mm	
5	11710	2	Klemming 15	
6	128500118	2	Kappe	
7	6522842	1	Achse	
8	128500116	1	seitl. Abdeckung. rechts	
9	128501674	1	PLASTIC PLUG	
11	128500135	1	Platte	
12	128500134	2	Stopfen	
13	128500133	2	Rohr	
14	128500130	1	Mutter M4X35 SP	
15	128500205	1	Handgriff	
16	128500132	2	Schraube M4X8 DZN7985	
18	128500143	1	Aufnahme oben	
19	128500144	1	Schlauchhalter	[1]
20	128500203	1	Schraube K50x45 WN1451	
21	128500136	1	Halter	
22	6520844	1	Reinigungsnadel	
23	128500207	1	Zubeh+rhalterung XT	
24	128501675	1	REAR COVER INSERT	
25	106408236	1	NILFISK-ALTO FOAMSPRAYER VARIO HF 0950	
27	128501678	1	RUBBER STRAP KIT 2.5L	
28	1814732	3	Ejotschraube KB50x18	
26	107141635	1	Reinigungsmitteltank	

Part Notes:

[1] - Not for machines with hose reel

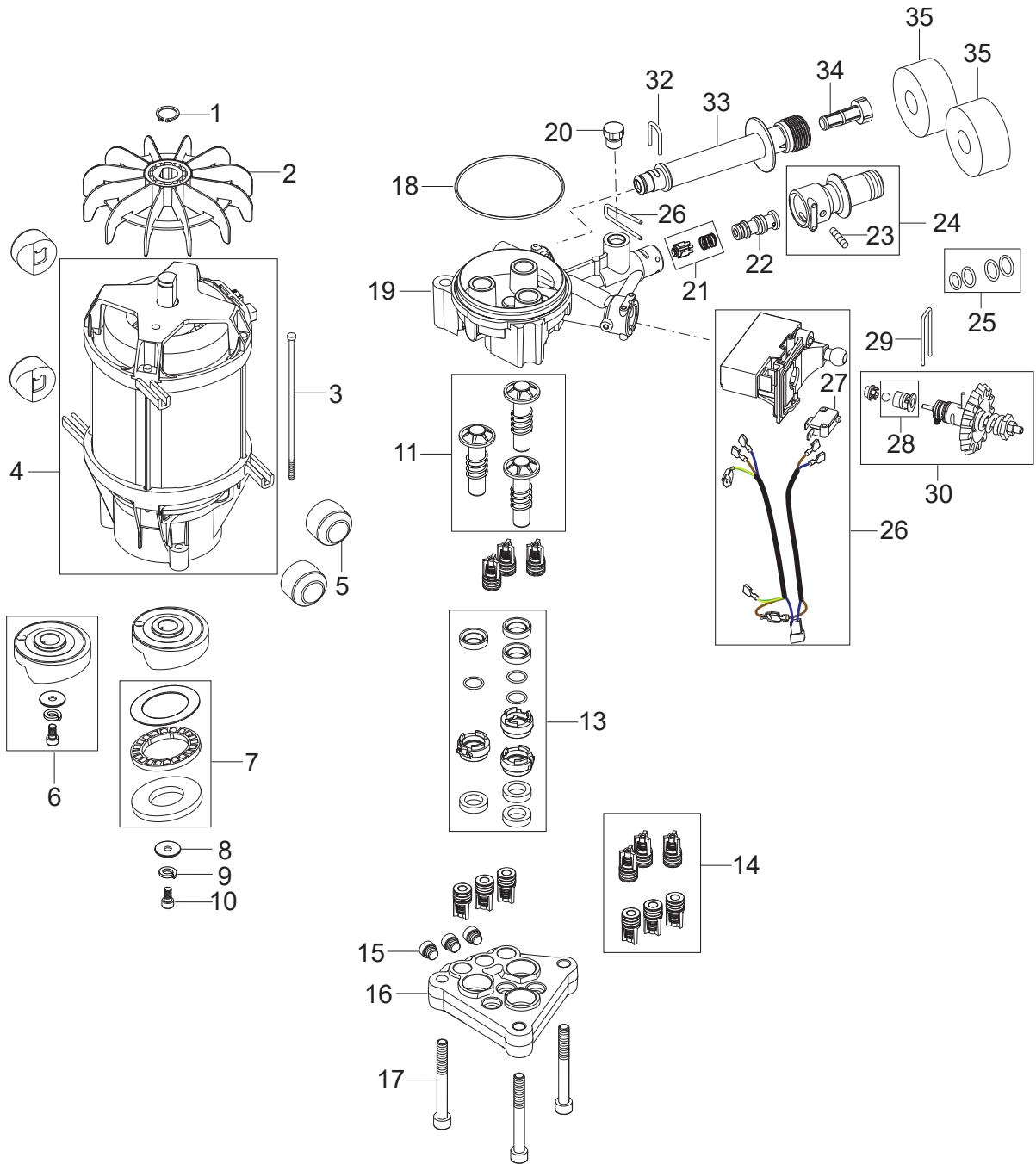

Pos.	Artikel-Nr.	Menge	Variante	Notes
0	5218602	1	Pumpenöl HV68 1x1l	
1	127500051	1	Sicherungsring	
2	127500040	1	Lüfterrad	
3	7180924	4	Schraube	
4	128500169	1	Elektromotor 230 V/50 Hz	[1]
4	128500979	1	MOTOR 2.9KW	[2]
5	128332334	4	Puffer	
6	128500173	1	Taumelscheibe 9,5°	[3]
6	128500175	1	Taumelscheibe 8,4°	[4]
6	128500172	1	Taumelscheibe 10 grad SP	[5]
7	1119705	1	Nadellager	
8	127130066	1	Beilagsscheibe D22X6,4X1,	
9	127500050	1	Federscheibe	
10	3913	1	Zylinderschraube M6x12	
11	301000836	1	Satz Kolben	
13	128500179	1	Dichtungssatz Kolben	
14	6526026	1	Ventil (6Stk.)	
15	6528586	3	Verschlussstopfen	
16	127440028	1	Ventilblock	
17	1814597	3	Zylinderschraube 8x70	
18	3003654	1	O-Ring 80,0 x 2,0 DIN	
19	128500981	1	CYLINDER BLOCK W/O MANOMETER	
20	128501683	1	PLUG WITH O-RING	
21	128500183	1	Rückschlagventil	
22	128501681	1	INJECTOR D3	[6]
22	128501680	1	INJECTOR D6	[7]
23	128500242	1	Schraube M5 DIN916	
24	128500186	1	Verbindungsstück	
25	128501660	1	O-RINGS KIT F. INJECTOR AND INSERT	
26	128500188	1	Schaltergehäuse	
27	128500196	1	Schalter	
28	128500190	1	Ventil	
29	128500191	1	Bügel	
30	128501682	1	VALVE PISTON COMPLETE	
31	6525619	1	Bügel	
32	128500200	1	Bügel	
33	128500194	1	Verbindungsstück	
34	128500195	1	Sieb	
35	126486792	2	Dämmeinlage	

Part Notes:

- [1] - MC 2C-150/650
- [2] - 120-520, 140-610
- [3] - MC 2C-140/610
- [4] - MC 2C-120/520, MC 2C-150/650 EXPT
- [5] - MC 2C-150/650, MC 2C-150/650
- [6] - MC 2C-120, MC 2C-150
- [7] - MC 2C-140

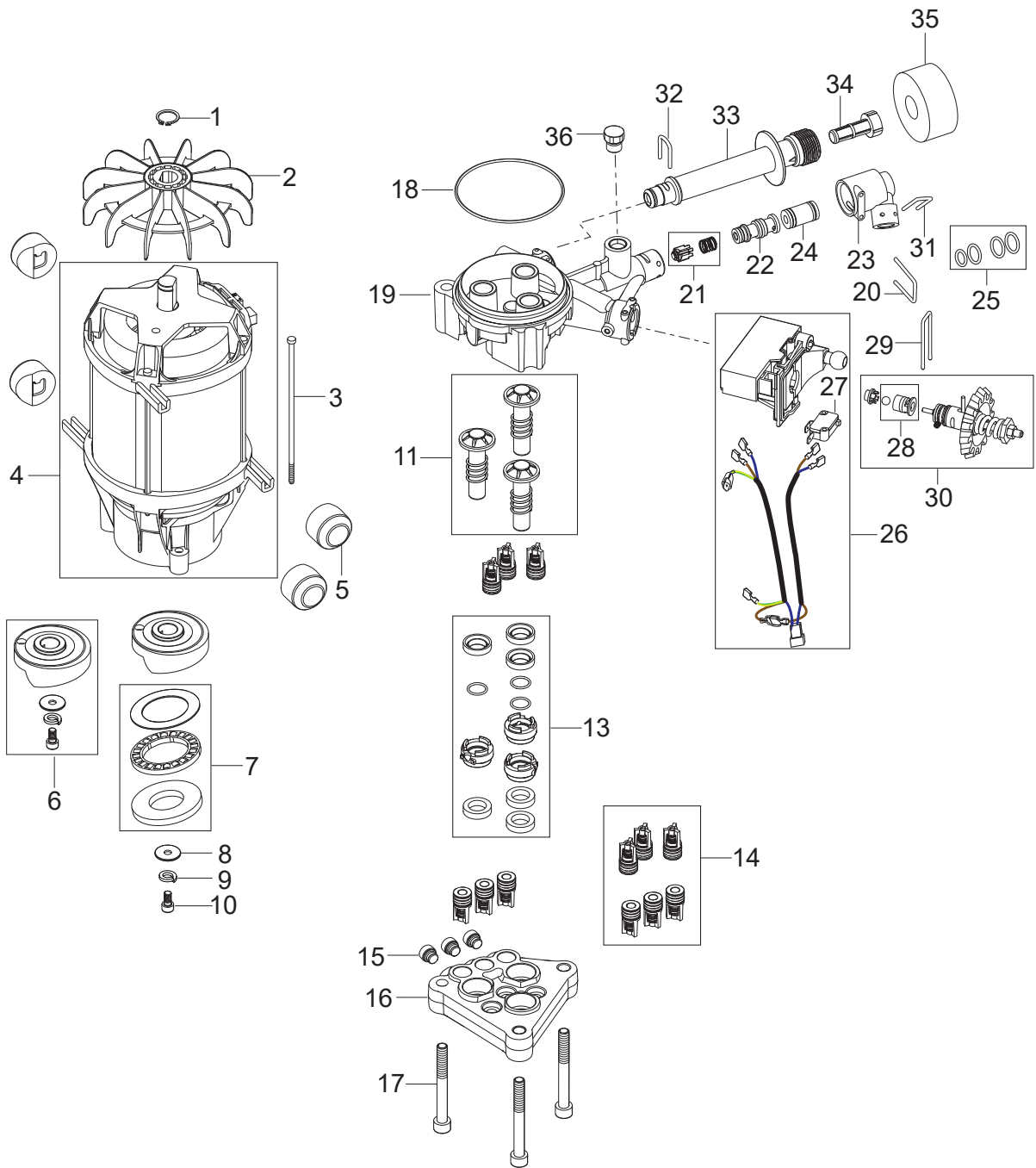

Pos.	Artikel-Nr.	Menge	Variante	Notes
0	5218602	1	Pumpenöl HV68 1x1l	
1	127500051	1	Sicherungsring	
2	127500040	1	Lüfterrad	
3	7180924	4	Schraube	
4	128500169	1	Elektromotor 230 V/50 Hz	[1]
4	128500979	1	MOTOR 2.9KW	[2]
5	128332334	4	Puffer	
6	128500173	1	Taumelscheibe 9,5°	[3]
6	128500175	1	Taumelscheibe 8,4°	[4]
6	128500172	1	Taumelscheibe 10 grad SP	[5]
7	1119705	1	Nadellager	
8	127130066	1	Beilagsscheibe D22X6,4X1,	
9	127500050	1	Federscheibe	
10	3913	1	Zylinderschraube M6x12	
11	301000836	1	Satz Kolben	
13	128500179	1	Dichtungssatz Kolben	
14	6526026	1	Ventil (6Stk.)	
15	6528586	3	Verschlussstopfen	
16	127440028	1	Ventilblock	
17	1814597	3	Zylinderschraube 8x70	
18	3003654	1	O-Ring 80,0 x 2,0 DIN	
19	128500981	1	CYLINDER BLOCK W/O MANOMETER	
20	128501328	1	U-PIN 3X20.3X45	
21	128500183	1	Rückschlagventil	
22	128501681	1	INJECTOR D3	[6]
22	128501680	1	INJECTOR D6	[7]
23	128500187	1	Verbindungsstück	
24	128501661	1	OUTLET INSERT W. O-RINGS	
25	128501660	1	O-RINGS KIT F. INJECTOR AND INSERT	
26	128500188	1	Schaltergehäuse	
27	128500196	1	Schalter	
28	128500190	1	Ventil	
29	128500191	1	Bügel	
30	128501682	1	VALVE PISTON COMPLETE	
31	6525619	1	Bügel	
32	128500200	1	Bügel	
33	128500194	1	Verbindungsstück	
34	128500195	1	Sieb	
35	126486792	2	Dämmeinlage	
36	128501683	1	PLUG WITH O-RING	

Part Notes:

- [1] - MC 2C-150/650
- [2] - 120-520, 140-610
- [3] - MC 2C-140/610
- [4] - MC 2C-120/520
- [5] - MC 2C-150/650, MC 2C-150/650
- [6] - MC 2C-120, MC 2C-150
- [7] - MC 2C-140

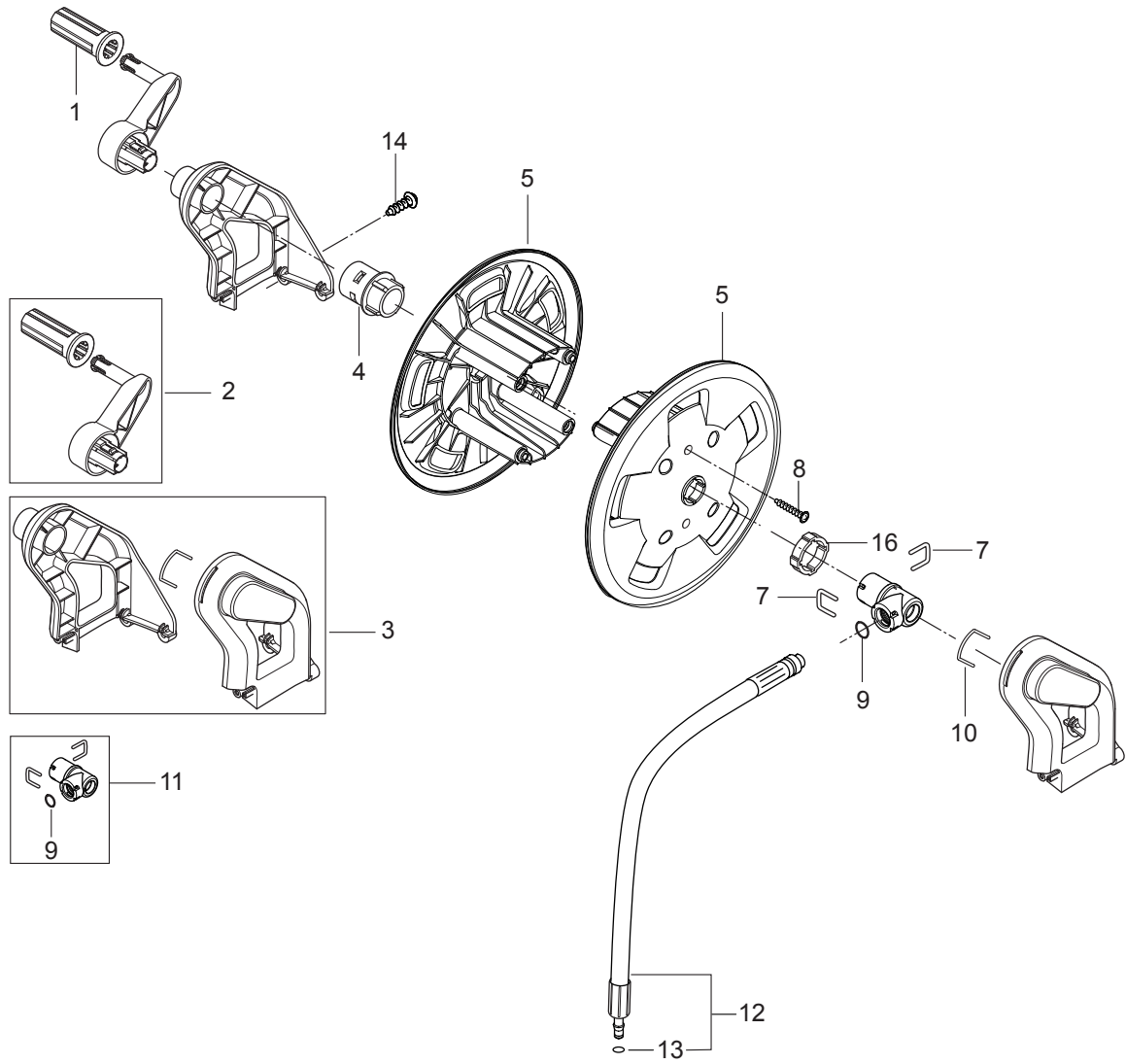

Pos.	Artikel-Nr.	Menge	Variante	Notes
1	128500750	1	HANDLE GRIB	
2	128500751	1	HANDLE FOR HOSE REEL PRO	
3	128500164	1	Führung	
4	128500869	1	AXLE FOR HOSE REEL	
5	6528570	2	Trommel	
7	6526487	2	Bügel	
8	128500595	2	SCREW K50X35 WN1452 BLACK TORX	
9	3002144	1	O-Ring 14,3 X 2,4 SMS	
10	127440229	1	Bügel	
11	127440011	1	Anschlussstück	
12	128500166	1	Hochdruckschlauch DN 6, 675 mm	
13	3004108	1	O-Ring 5,28X1,78	
14	107141838	2	SCHRAUBE K50X18 WN1451 SCHWARZ TORX 20	
16	128500167	1	Scheibe	

Default accessories

Pos.	Artikel-Nr.	Menge	Variante	Notes
1	106403122	1	ERGO 2000 STANDARD W. HOSE SWIVEL	
2	101119496	1	Schlauchkupplung Rep.Satz	
3	106408250	1	4-IN-1 LANCE INCL 0340 ALUMINUM HEAD	
4	106402282	1	FLEXOPOWER PLUS 960	
4A	101119735	1	HD-Düse 0340 TORNADO	
5	126528620	1	Schlauch, kpl., POSEIDON	[1]
5	6528613	1	Schlauch kpl.15m ERGO	[2]
	1605872	1	QUICK COUPLING NIPPLE	

Part Notes:

- [1] - Hoses - MC 2C, MC 2C XT
 [2] - XT
 Hoses - MC 2C, MC 2C XT

