

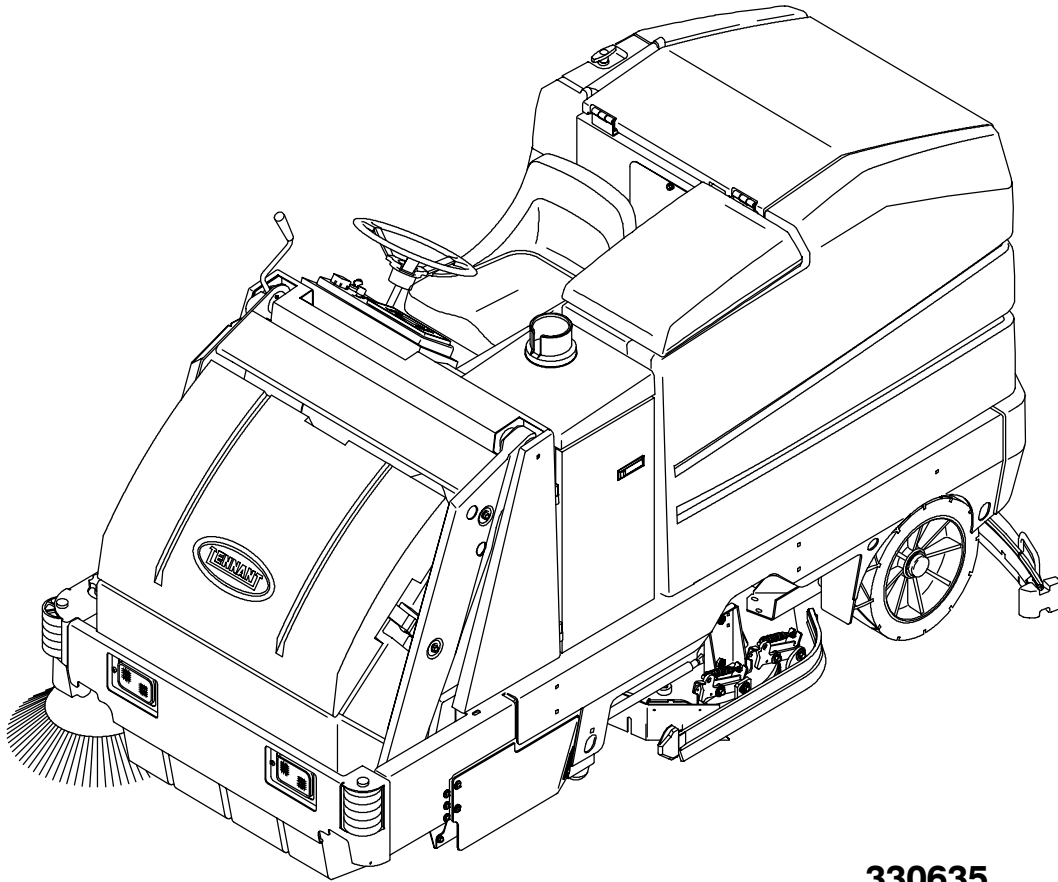

8300

Service Manual



330635

Rev. 02 (5-02)





This service manual is intended to be used as an aid in the detailed service, repair, and troubleshooting of your TENNANT Model 8300.

The set is organized into six major groups: General Information, Chassis, Sweeping, Scrubbing, Electrical, and Hydraulics.

General Information: Safety precautions, machine specifications, machine maintenance chart, machine tying, machine jacking, machine storing, machine pushing or towing, and hardware information.

Chassis: Tire/wheel replacement, brake adjustment and replacement, steering adjustment and replacement.

Sweeping: Hopper adjustments, brush repair/replacement, skirt/seal repair/replacement, and sweeping troubleshooting.

Scrubbing: Scrub head repair/replacement, brush repair/replacement, skirt/seal repair/replacement, squeegee repair/replacement, solution and recovery tank repair/replacement, and scrubbing troubleshooting.

Electrical: Battery maintenance and replacement, electrical schematics, and electrical troubleshooting.

Hydraulics: Valve replacement, motor replacement, cylinder replacement, pump replacement, filter replacement, hydraulic schematic, and hydraulic troubleshooting.

Manual Number - 330635

Revision: 02

Published: 5-02

Copyright © 2000, 2001, 2002 TENNANT, Printed in U.S.A.

CONTENTS

	Page
SAFETY PRECAUTIONS	1-3
SPECIFICATIONS	1-7
GENERAL MACHINE	
DIMENSIONS/CAPACITIES ...	1-7
GENERAL MACHINE	
PERFORMANCE	1-7
POWER TYPE	1-8
STEERING	1-9
HYDRAULIC SYSTEMS	1-9
BRAKING SYSTEM	1-9
TIRES	1-9
MACHINE DIMENSIONS	1-10
PUSHING, TOWING, AND	
TRANSPORTING THE MACHINE	1-11
PUSHING OR TOWING THE	
MACHINE	1-11
TRANSPORTING THE MACHINE	1-11
MACHINE JACKING	1-13
STORAGE INFORMATION	1-14
MACHINE TROUBLESHOOTING ...	1-15
MAINTENANCE	1-17
MAINTENANCE CHART	1-17
HARDWARE INFORMATION	1-19
STANDARD BOLT TORQUE	
CHART	1-19
METRIC BOLT TORQUE CHART	1-19
BOLT IDENTIFICATION	1-19
THREAD SEALANT AND LOCKING	
COMPOUNDS	1-19
HYDRAULIC FITTING INFORMATION ..	1-20
HYDRAULIC TAPERED PIPE FITTING	
(NPT) TORQUE CHART	1-20
HYDRAULIC TAPERED SEAT FITTING	
(JIC) TORQUE CHART	1-20
HYDRAULIC O-RING FITTING	
TORQUE CHART	1-20

SAFETY PRECAUTIONS

The following symbols are used throughout this manual as indicated in their description:



WARNING: To warn of hazards or unsafe practices that could result in severe personal injury or death.

FOR SAFETY: To identify actions that must be followed for safe operation of equipment.

The following information signals potentially dangerous conditions to the operator or equipment. Read this manual carefully. Know when these conditions can exist. Locate all safety devices on the machine. Then, take necessary steps to train machine operating personnel. Report machine damage or faulty operation immediately. Do not use the machine if it is not in proper operating condition.



WARNING: Batteries emit hydrogen gas. Explosion or fire can result. Keep sparks and open flame away. Keep covers open when charging.



WARNING: Flammable materials can cause an explosion or fire. Do not use flammable materials in tank(s).



WARNING: Flammable materials or reactive metals can cause explosion or fire. Do not pick up.



WARNING: Moving belt and fan. Keep away.



WARNING: Lift arm pinch point. Stay clear of hopper lift arms.



WARNING: Raised hopper may fall. Engage hopper support bar.

FOR SAFETY:

1. **Do not operate machine:**
 - Unless trained and authorized.
 - Unless operation manual is read and understood.
 - In flammable or explosive areas unless designed for use in those areas.
 - In areas with possible falling objects unless equipped with overhead guard.

2. **Before starting machine:**
 - Make sure all safety devices are in place and operate properly.
 - Check brakes and steering for proper operation.
3. **When starting machine:**
 - Keep foot on brake and directional pedal in neutral.
4. **When using machine:**
 - Use brakes to stop machine.
 - Go slow on inclines and slippery surfaces.
 - Use care when backing machine.
 - Do not carry riders on machine.
 - Follow mixing and handling instructions on chemical containers.
 - Always follow safety and traffic rules.
 - Report machine damage or faulty operation immediately.
5. **Before leaving or servicing machine:**
 - Stop on level surface.
 - Set parking brake.
 - Turn off machine and remove key.
6. **When servicing machine:**
 - Avoid moving parts. Do not wear loose jackets, shirts, or sleeves when working on machine.
 - Block machine tires before jacking machine up.
 - Jack machine up at designated locations only. Block machine up with jack stands.
 - Use hoist or jack that will support the weight of the machine.
 - Wear eye and ear protection when using pressurized air or water.
 - Disconnect battery connections before working on machine.
 - Avoid contact with battery acid.
 - Use Tennant supplied or equivalent replacement parts.

7. When loading/unloading machine onto/off truck or trailer:
 - Turn off machine.
 - Use truck or trailer that will support the weight of the machine.
 - Use winch. Do not drive the machine onto/off the truck or trailer unless the load height is 380 mm (15 in) or less from the ground.
 - Set parking brake after machine is loaded.
 - Block machine tires.
 - Tie machine down to truck or trailer.

The safety labels appear on the machine in the locations indicated. If these or any label becomes damaged or illegible, install a new label in its place.

FOR SAFETY LABEL - LOCATED ON THE INSIDE OF THE OPERATOR COMPARTMENT.

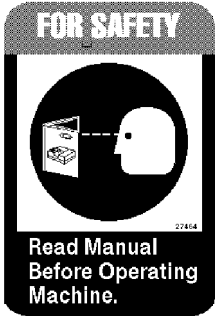

BATTERY CHARGING LABEL - LOCATED ON THE LINTEL.

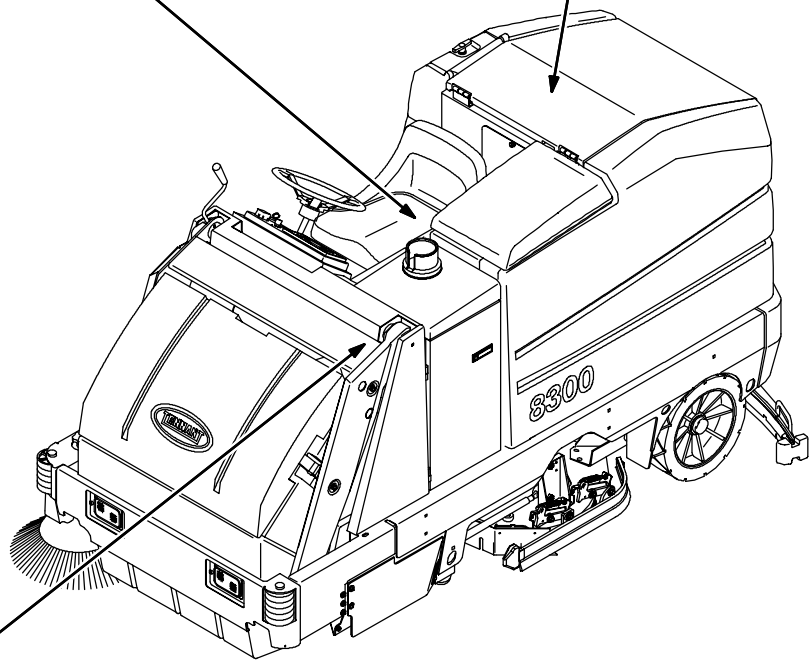
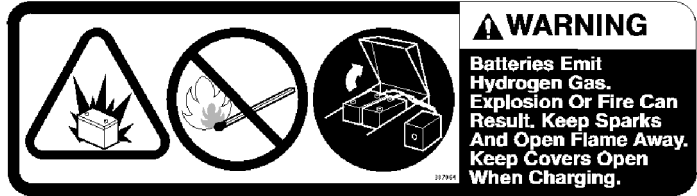

ENGINE FAN AND BELT LABEL - LOCATED ON THE VACUUM FAN SHROUD.

GENERAL INFORMATION

FLAMMABLE SPILLS LABEL - LOCATED ON THE INSIDE OF THE OPERATOR COMPARTMENT.



FLAMMABLE MATERIALS LABEL - LOCATED ON THE INSIDE OF THE SOLUTION TANK COVER.

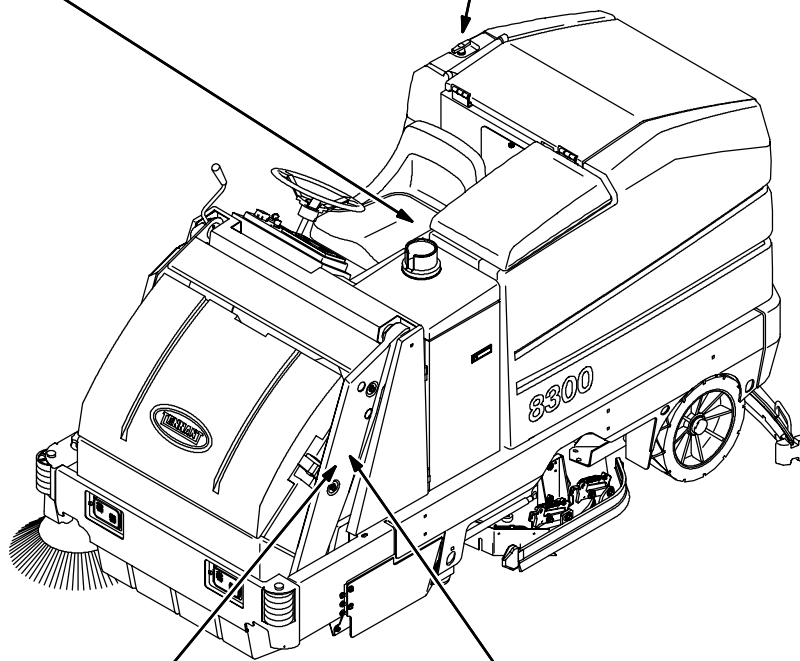

HOPPER SUPPORT BAR LABEL - LOCATED ON THE HOPPER SUPPORT BAR AND ON BOTH HOPPER LIFT ARMS.



HOPPER LIFT ARMS LABEL - LOCATED ON BOTH HOPPER LIFT ARMS.

353391

SPECIFICATIONS

GENERAL MACHINE DIMENSIONS/CAPACITIES

Item	Dimension/capacity
Length	2641 mm (104 in)
Width, frame (with dual side brushes)	1220 mm (48.5 in)
Height, standard	1450 mm (57 in)
Height with overhead guard option	2070 mm (81.5 in)
Cylindrical brush diameter	229 mm (9 in)
Sweeping path width, single side brush (RH)	1270 mm (50 in)
Sweeping path width, dual side brushes	1625 mm (64 in)
Hopper weight capacity	135 kg (300 lbs)
Hopper volume capacity	84.6 L (3 ft ³)
Dust filter area	4.8m ² (52.5 ft ²)
Solution tank capacity	216 L (57 gal)
Recovery tank capacity	216 L (57 gal)
Tank capacity with ES™ option	340 L (90 gal)
Propelling gear box 90 wt. gear lubricant capacity	2.7 L (2.7 qt)
Ceiling height minimum dumping clearance	1525 mm (60 in)
GVWR	2060 kg (4580 lb)

Item	Max Pro™ 1000	Max Pro™ 1200
Disc brush diameter	510 mm (20 in)	406 mm (16 in)
Cylindrical brush length	978 mm (38.5 in)	1180 mm (46.5 in)
Rear Squeegee width	1300 mm (51 in)	1510 mm (59.5 in)
Scrubbing path width	1020 mm (40 in)	1220 mm (48 in)

GENERAL MACHINE PERFORMANCE

Item	Measure
Maximum forward speed	8.9 km/h (5.5 mph)
Maximum reverse speed	4.8 km (3mph)
Minimum turning radius, left	4547 mm (179 in)
Minimum turning radius, right	4648 mm (183 in)
Minimum aisle turn	2946 mm (116 in)
Maximum rated climb and descent angle with full tanks	6°
Maximum rated climb and descent angle with empty tanks	8°

GENERAL INFORMATION

POWER TYPE

Type	Quantity	Volts	Ah Rating	Weight
Batteries, Dry	1	36	500 @ 6 hr rate	617 kg (1370 lb)
	1	36	750 @ 6 hr rate	893 kg (1984 lb)
Batteries, Sealed	1	36	600 @ 6 hr rate	810 kg (1800 lb)
Batteries, Wet	1	36	380 @ 6 hr rate	436 kg (960 lb)
	1	36	500 @ 6 hr rate	617 kg (1370 lb)
	1	36	750 @ 6 hr rate	893 kg (1984 lb)

Type	Use	VDC	Kw (hp)
Electric Motors	Sweep brush	36	0.60 (.8)
	Scrub brush	36	0.75 (1)
	Heavy Duty scrub brush	36	1.12 (1.5)
	Vacuum fan	36	0.63 (0.85)
	Propelling	36	3.4 (4.6)

Type	VDC	amp	Hz	Phase	VAC
Chargers	36	75	60	1	208-240-480
	36	75	60	3	208-240-480
	36	120	60	1	208-240-480
	36	120	60	3	208-240-480
	36	150	60	1	208-240-480
	36	150	60	3	208-240-480
	36	93	60	1	208-240-480
	36	93	60	3	208-240-480

STEERING

Type	Power source	Emergency steering
Front wheel, hydraulic and rotary valve controlled	Hydraulic	Manual

HYDRAULIC SYSTEMS

System	Capacity	Fluid Type
Hydraulic reservoir	1.9L (0.5 gal)	TENNANT part no. 65869
Hydraulic total	2.6L (0.65 gal)	TENNANT part no. 65870

BRAKING SYSTEM

Type	Operation
Service brakes	Mechanical drum brakes (2), one per rear wheel, cable actuated
Parking brake	Utilizes service brakes, cable actuated

TIRES

Location	Type	Size
Front (1)	Solid	413 X 152 mm (16.25 x 6 in)
Rear (2)	Solid	406 X 127 mm (16 x 5 in)

GENERAL INFORMATION

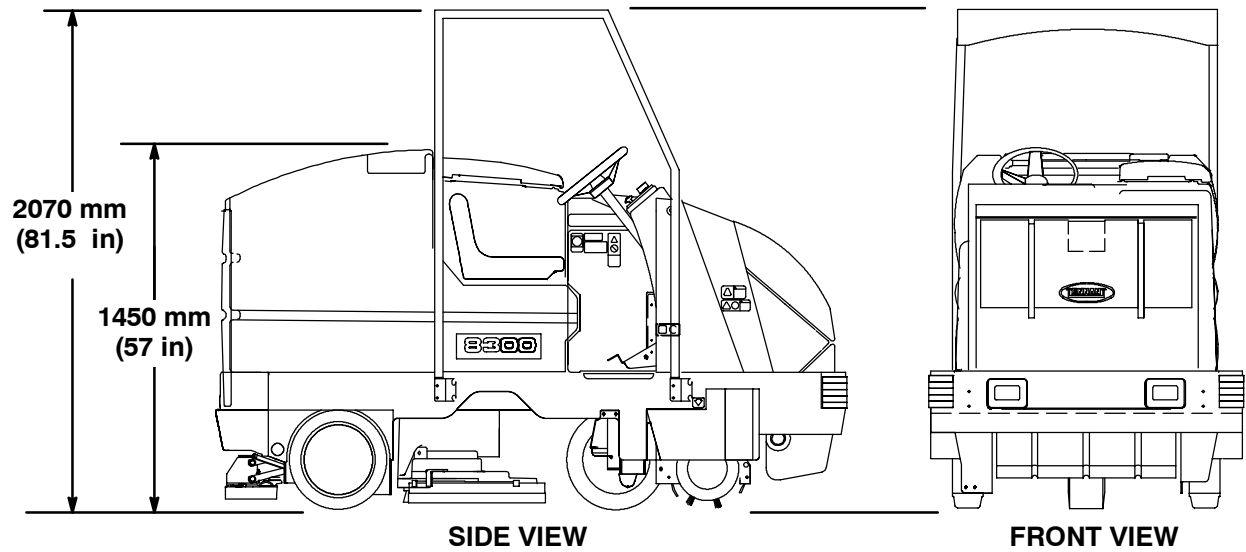
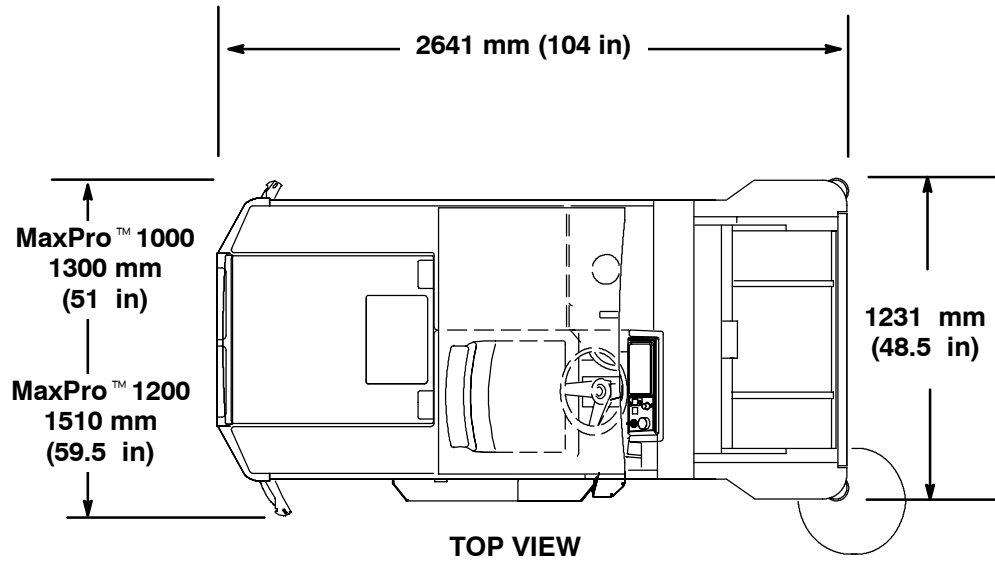

353382

MACHINE DIMENSIONS

PUSHING, TOWING, AND TRANSPORTING THE MACHINE

PUSHING OR TOWING THE MACHINE

If the machine becomes disabled, it can be pushed from the front or rear, but only tow it from the front.

Only push or tow the machine for a *very short distance* and do not exceed 3.2 kp/h (2 mph). It is NOT intended to be pushed or towed for a long distance or at a high speed.

ATTENTION! Do not push or tow machine for a long distance or damage may occur to the propelling system.

TRANSPORTING THE MACHINE

1. Position the front of the machine at the loading edge of the truck or trailer.

FOR SAFETY: Use a truck or trailer that will support the weight of the machine.

NOTE: Empty the recovery and solution tanks before transporting the machine.

2. If the loading surface is not horizontal or is higher than 380 mm (15 in) from the ground, use a winch to load machine.

If the loading surface is horizontal AND is 380 mm (15 in) or less from the ground, the machine may be driven onto the truck or trailer.

3. To winch the machine onto the truck or trailer, attach the winching chains to the front tie down locations. The front tie-down locations are on the front sides of the machine. Make sure the machine is centered.

FOR SAFETY: When loading machine onto truck or trailer, use winch. Do not drive the machine onto the truck or trailer unless the loading surface is horizontal AND is 380 mm (15 in) or less from the ground.

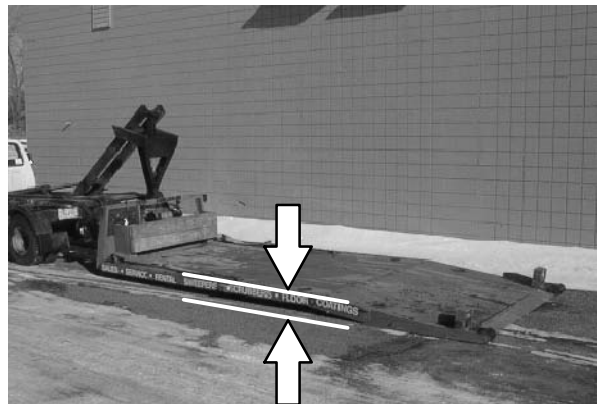

GENERAL INFORMATION

4. Position the machine onto the truck or trailer as far as possible. If the machine starts to veer off the centerline of the truck or trailer, stop and turn the steering wheel to center the machine.
5. Set the parking brake, lower the scrub head and block the machine tires. Tie down the machine to the truck or trailer before transporting.

The front tie-down locations are on the front sides of the machine.



The rear tie-down locations are on the rear corners of the machine.

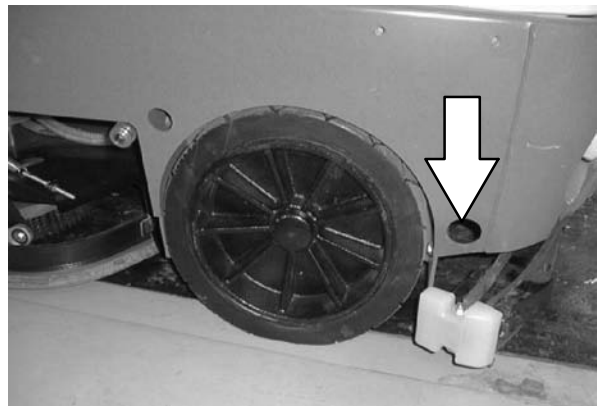

6. If the loading surface is not horizontal or is higher than 380 mm (15 in) from the ground, use a winch to unload machine.

If the loading surface is horizontal AND is 380 mm (15 in) or less from the ground, the machine may be driven off the truck or trailer.

FOR SAFETY: When unloading machine off truck or trailer, use winch. Do not drive the machine off the truck or trailer unless the loading surface is horizontal AND 380 mm (15 in) or less from the ground.

MACHINE JACKING

You can jack up the machine for service at the designated locations. Use a jack that will support the weight of the machine. Always stop the machine on a flat, level surface and block the tires before jacking up the machine.

The front jacking locations are located on both sides of the machine, behind the sweeping assembly.

FOR SAFETY: Before leaving or servicing machine, stop on level surface, set parking brake.

FOR SAFETY: When servicing machine, use a hoist or jack that will support the weight of the machine.

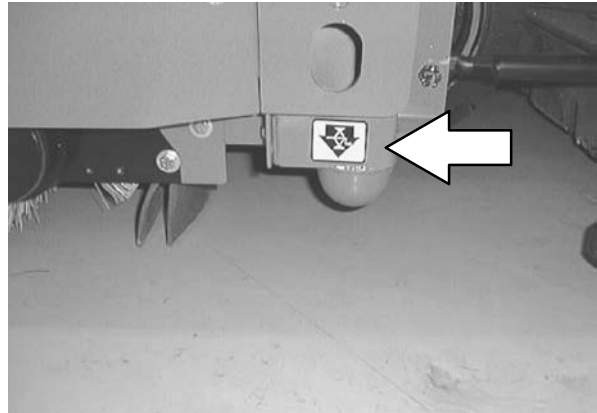

The rear jacking locations are located on the rear bumper, behind the rear tires.

FOR SAFETY: When servicing machine, block machine tires before jacking machine up.

FOR SAFETY: When servicing machine, jack machine up at designated locations only. Block machine up with jack stands.

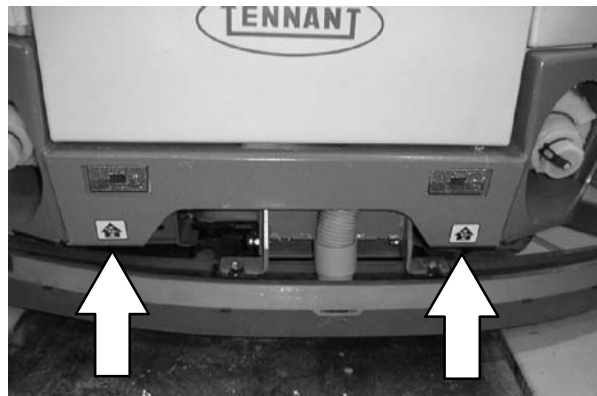

STORAGE INFORMATION

The following steps should be taken when storing the machine for extended periods of time.

1. Drain and clean the solution and recovery tanks.

ES™ machines: Run clean water through the solution system and the ES™ solution pump.
2. Raise the rear squeegee and the scrub head.
3. Park the machine in a cool, dry area.
4. Remove the batteries, or charge them after every three months.

MACHINE TROUBLESHOOTING

Problem	Cause	Remedy
Trailing water – poor or no water pickup	Rear squeegee blades worn	Rotate or replace blades
	Rear squeegee out of adjustment	Adjust rear squeegee
	Rear squeegee raised	Lower rear squeegee
	Rear squeegee tube clogged	Flush squeegee tube
	Side squeegees raised	Lower side squeegees
	Side squeegee blades worn	Replace side squeegee blades
	Side squeegees out of adjustment	Adjust side squeegees
	Too much solution flow to floor	Reduce solution flow to floor
	Vacuum hose clogged	Flush vacuum hoses
	Recovery tank cover not seated	Reseat tank cover
	Recovery tank cover seal worn	Replace seal
	Recovery tank full	Drain recovery tank
	Float stuck shutting off vacuum	Clean float
	Debris caught on rear squeegee	Remove debris
	Foam filling recovery tank	Empty recovery tank; use less or change detergent
Vacuum hose to rear squeegee disconnected or damaged	Reconnect or replace vacuum hose	
Vacuum fan will not turn on	Recovery tank full	Drain recovery tank
	Vacuum fan circuit breaker tripped	Reset circuit breaker
	Machine in reverse or neutral	Propel forward
	Vacuum fan failure	Contact Tennant service representative
Little or no solution flow to the floor	Solution tank empty	Fill solution tank
	Solution flow lever off	Open solution flow lever
	Solution supply lines plugged	Flush solution supply lines
	ES™ switch off	Turn ES™ switch on
	Manual control valve closed	Open valve more

GENERAL INFORMATION

Problem	Cause	Remedy
Poor scrubbing performance	Debris caught on scrub brushes	Remove debris
	Improper detergent or brushes used	Check with TENNANT representative for advice
	Scrub brush pressure not set properly	Replace scrub brushes
	Worn scrub brushes	Replace scrub brushes
ES™ system does not fill solution tank	Clogged solution pump or lines	Flush ES™ system
	ES™ float switch(es) stuck	Clean switch floats of debris
	Clogged ES™ pump filter	Clean ES™ filter
	Water levels too low in tanks	Add water to tanks
Excessive dusting	Brush skirts and dust seals worn, damaged, out of adjustment	Replace or adjust brush skirts or dust seals
	Hopper dust filter clogged	Shake and/or clean or replace dust filter
	Sweeping vacuum will not activate	Make sure hopper is in the lowered position
		Reset Thermo Sentry™
		Contact Tennant service representative
	Thermo Sentry™ tripped	Reset Thermo Sentry™
Poor sweeping performance	Brush bristles worn	Replace brushes
	Sweeping brushes not properly adjusted	Adjust brushes
	Debris caught in brush drive mechanism	Remove debris
	Brush drive failure	Contact Tennant service representative
	Hopper full	Empty hopper
	Hopper lip skirts worn or damaged	Replace lip skirts

MAINTENANCE

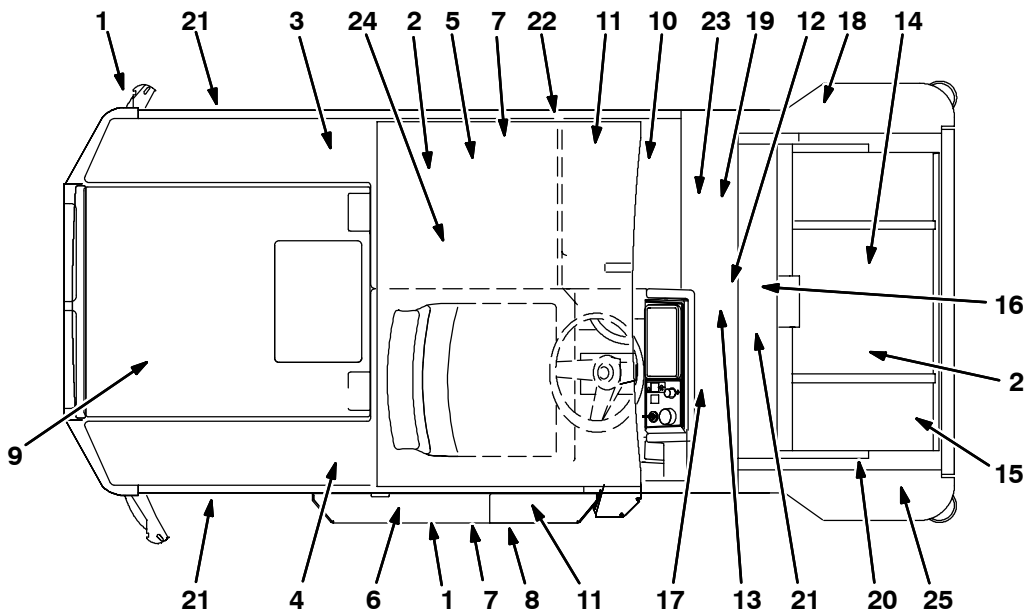

MAINTENANCE CHART

Interval	Key	Description	Procedure	Lubricant/ Fluid	No. of Service Points
Daily	1	Rear and side squeegees	Check for damage, wear and adjustment	-	3
				-	1
	2	Brushes	Check for damage and wear	-	5, (6)
	3	Recovery tank	Clean	-	1
	3	Recovery tank, ES™ mode	Clean ES™ filter	-	1
	4	Solution tank, ES™ mode	Clean and flush	-	1
	5	Vacuum fan filter	Clean and flush	-	1
	6	Debris trough (Cylindrical brushes only)	Check and clean	-	1
	14	Debris hopper	Clean	-	1
	15	Dust filter	Clean	-	1
	-	Machine	Check for leaks	-	1
50 Hours	7	Cylindrical scrub brushes	Check Taper	-	2
			Rotate front to rear	-	2
	8	Scrub head floor skirts (Disk brush heads only)	Check for damage and wear	-	1
	14	Sweeping assembly side and recirculation skirts	Check for damage and wear	-	4
	9	Front flap skirt	Check for damage and wear	-	1
9	Battery cells	Check electrolyte level	DW	1	

GENERAL INFORMATION

Interval	Key	Description	Procedure	Lubricant/ Fluid	No. of Service Points
100 Hours	16	Cylindrical conveyor	Check for damage and wear	-	1
	17	Brakes	Check adjustment	-	1
	18	Sweeping brush drive belts	Check for damage, adjustment or wear	-	2
	19	Sweeping vacuum fan belt	Check for damage, adjustment or wear	-	1
	7	Cylindrical scrub brush drive belts	Check for damage, adjustment or and wear	-	1
	14	Hopper seals	Check for damage and wear	-	5
	15	Hopper filter and seals	Check for damage, clean or re-place	-	2
	20	Hopper lift arms	Lubricate	SPL	4
	11	Machine and tank cover seals	Check for damage and wear	-	5
	10	Hydraulic fluid	Check fluid level	HYDO	1
	12	Front wheel support bearing	Lubricate	SPL	1
	13	Propelling gearbox	Check lubricant level	GL	1
	22	Scrub head drag link arm pivot points	Lubricate	SPL	8(4)
	21	Tires	Check for damage and wear	-	3
500 Hours	12	Front wheel	■ Torque wheel nuts	-	1
	12	Rear wheel bearings	Check, lubricate, and adjust	SPL	1
	24	Scrub head gas spring	Check for wear and operation	-	1
	17	Steering gear chain	■ Check tension and lubricate	GL	1
	20	Hopper drive chains	■ Check tension and lubricate	GL	2
	24	Sweeping vacuum fan motors	Check motor brushes	-	2
	23	Scrubbing vacuum fan motors	Check motor brushes	-	2
	10	Hydraulic fluid	Drain and replace	HYDO	1
	10	Hydraulic fluid filter	Change filter element	-	1
	10	Hydraulic hoses	Check for damage and wear	-	1
1000 Hours	13	Propelling gearbox	■ Change fill-level plug seals	-	1
			■ Change gear lubricant	GL	1
	24	Scrubbing brush drive motors	Check motor brushes	-	2
	25	Side brush drive motor(s)	Check motor brushes	-	2
	24	Sweeping brush drive motors	Check motor brushes	-	2
13	Propelling motor	Check motor brushes	-	1	

SPL - Special lubricant, Lubriplate EMB grease (Tennant part no. 01433-1)

GL - SAE 90 weight gear lubricant

HYDO - TENNANT or approved hydraulic fluid

DW - Distilled water

NOTE: Also check procedures indicated (■) after the first 50-hours of operation.

HARDWARE INFORMATION

The following charts state standard plated hardware tightening ranges for normal assembly applications. Decrease the specified torque by 20% when using a thread lubricant. Do not substitute lower grade hardware for higher grade hardware. If higher grade hardware than specified is substituted, tighten only to the specified hardware torque value to avoid damaging the threads of the part being threaded into, as when threading into speed nuts or weldments.

NOTE: Decrease torque by 20% when using a thread lubricant.

Exceptions to the above chart:





Check the machine for exceptions!

STANDARD BOLT TORQUE CHART

Thread Size	SAE Grade 5 Torque ft lb (Nm)	SAE Grade 8 Torque ft lb (Nm)
0.25 in	7-10 (9-14)	10-13 (14-38)
0.31 in	15-20 (20-27)	20-26 (27-35)
0.38 in	27-35 (37-47)	36-47 (49-64)
0.44 in	43-56 (58-76)	53-76 (72-103)
0.50 in	65-85 (88-115)	89-116 (121-157)
0.62 in	130-170 (176-231)	117-265 (159-359)
0.75 in	215-280 (291-380)	313-407 (424-552)
1.00 in	500-650 (678-881)	757-984 (1026-1334)

NOTE: Decrease torque by 20% when using a thread lubricant.

BOLT IDENTIFICATION

Identification Grade Marking	Specification and Grade
	SAE-Grade 5
	SAE-Grade 8
	ISO-Grade 8.8
	ISO-Grade 10.9

01395

THREAD SEALANT AND LOCKING COMPOUNDS

Thread sealants and locking compounds may be used on this machine. They include the following:

Loctite 515 sealant – gasket forming material. TENNANT Part No. 75567, 15 oz (440 ml) cartridge.

Loctite 242 blue – medium strength thread locking compound. TENNANT Part No. 32676, 0.5 ml tube.

Loctite 271 red – high strength thread locking compound. TENNANT Part No. 19857, 0.5 ml tube.

METRIC BOLT TORQUE CHART

Thread Size	Class 8.8 Torque ft lb (Nm)	Class 10.9 Torque ft lb (Nm)
M4	2 (3)	3 (4)
M5	4 (5)	6 (8)
M6	7 (9)	10 (14)
M8	18 (24)	25 (34)
M10	32 (43)	47 (64)
M12	58 (79)	83 (112)
M14	94 (127)	133 (180)
M16	144 (195)	196 (265)
M20	260 (352)	336 (455)
M24	470 (637)	664 (900)

GENERAL INFORMATION

HYDRAULIC FITTING INFORMATION

HYDRAULIC TAPERED PIPE FITTING (NPT) TORQUE CHART

NOTE: Ratings listed are when using teflon thread seal.

Size	Minimum Torque	Maximum Torque
1/4 NPT	10 ft lb (14 Nm)	30 ft lb (41 Nm)
1/2 NPT	25 ft lb (34 Nm)	50 ft lb (68 Nm)
3/4 NPT	50 ft lb (68 Nm)	100 ft lb (136 Nm)

HYDRAULIC TAPERED SEAT FITTING (JIC) TORQUE CHART

Tube O.D. (in)	Thread Size	Maximum Torque
0.25	0.44-20	9 ft lb (12 Nm)
0.38	0.56-18	20 ft lb (27 Nm)
0.50	0.75-16	30 ft lb (41 Nm)
0.62	0.88-14	40 ft lb (54 Nm)
0.75	1.12-12	70 ft lb (95 Nm)
1.0	1.31-12	90 ft lb (122 Nm)

HYDRAULIC O-RING FITTING TORQUE CHART

Tube O.D. (in)	Thread Size	Minimum Torque	Maximum Torque
0.25	0.44-20	6 ft lb (8 Nm)	9 ft lb (12 Nm)
0.38	0.56-18	13 ft lb (18 Nm)	20 ft lb (27 Nm)
		*10 ft lb (14 Nm)	12 ft lb (16 Nm)
0.50	0.75-16	20 ft lb (27 Nm)	30 ft lb (41 Nm)
		*21 ft lb (28 Nm)	24 ft lb (33 Nm)
0.62	0.88-14	25 ft lb (34 Nm)	40 ft lb (54 Nm)
0.75	1.12-12	45 ft lb (61 Nm)	70 ft lb (95 Nm)
1.0	1.31-12	60 ft lb (81 Nm)	90 ft lb (122 Nm)

NOTE: Do not use sealant on o-ring threads.

*Aluminum bodied components

CONTENTS

	Page
INTRODUCTION	2-3
BRAKES AND TIRES	2-4
SERVICE BRAKES	2-4
TO ADJUST SERVICE BRAKES	2-4
TO REPLACE BRAKE SHOES	2-7
REAR TIRES AND WHEELS	2-11
TO REPACK REAR WHEEL BEARINGS	2-11
FRONT TIRE AND WHEEL, AND WHEEL DRIVE SUPPORT	2-14
FRONT WHEEL SUPPORT AND BEARING	2-14
PROPELLING GEARBOX	2-14
TO REPLACE FRONT DRIVE GEAR BOX	2-15
STEERING CHAIN	2-25
TO ADJUST STEERING CHAIN TENSION	2-25
MANUAL STEERING CHAIN ADJUSTMENT	2-26
POWER STEERING CHAIN ADJUSTMENT	2-26
HURTH GEAR BOX EXPLODED VIEW (LOWER SECTION)	2-27
HURTH GEAR BOX EXPLODED VIEW (UPPER SECTION)	2-28
HURTH GEAR BOX REPAIR INFO	2-29

INTRODUCTION

This section includes information on the main chassis related components for example the steering, brakes, and tires.

BRAKES AND TIRES

SERVICE BRAKES

The mechanical service brakes are located on the rear wheels. The brakes are operated by the foot brake pedal located in the operators compartment.

Check the brake adjustment every 200 hours of operation.

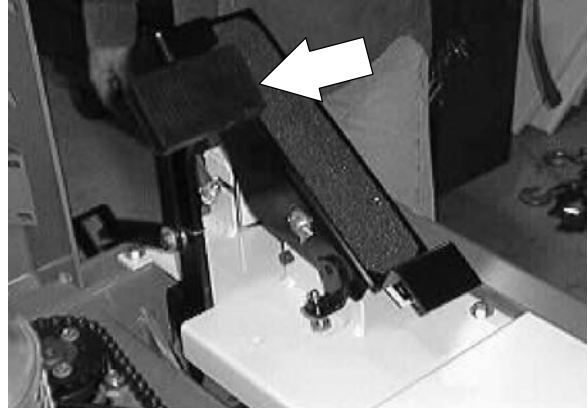

TO ADJUST SERVICE BRAKES

FOR SAFETY: Before Leaving Or Servicing Machine; Stop On Level Surface, Set Parking Brake, Turn Off Machine And Remove Key.

1. Make sure the parking brake is not engaged. Open the RH sweep brush door.

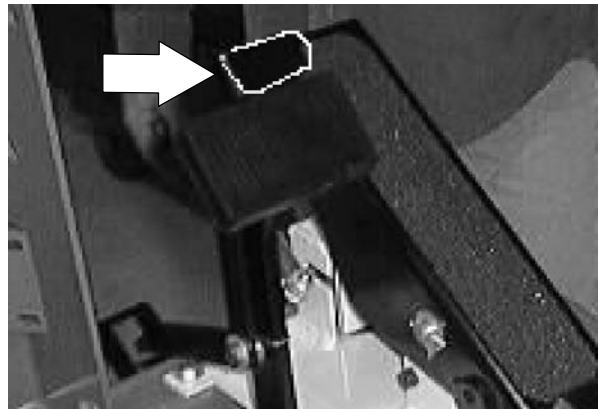

2. Go under the front, right corner of machine frame. Locate the brake cable assembly.

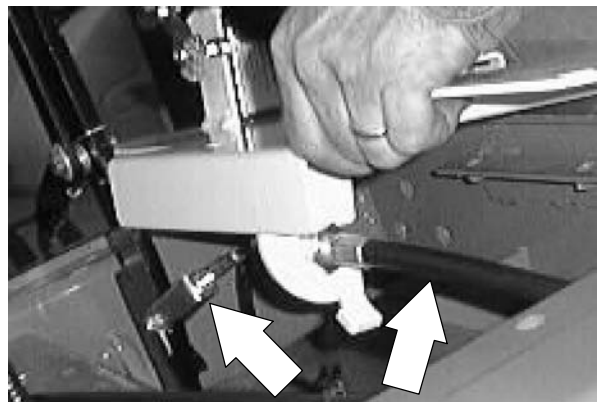

3. Loosen the large jam nuts on the brake cable at the floor plate mounting tab.

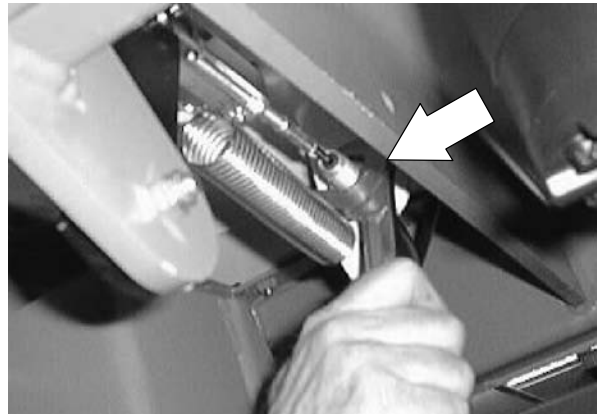

4. Move the brake cable forward or backward to adjust the pedal throw.

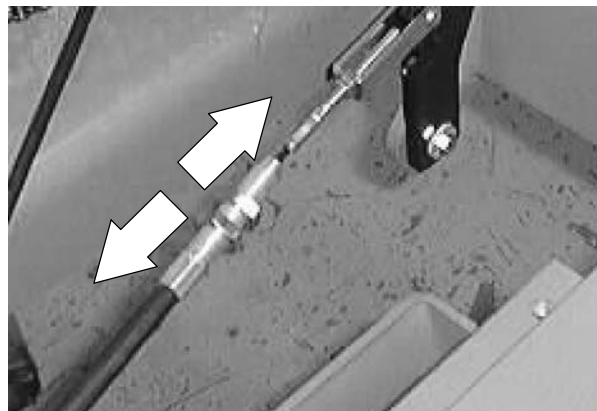

5. Retighten the large jam nuts on the brake cable at the floor plate mounting tab.

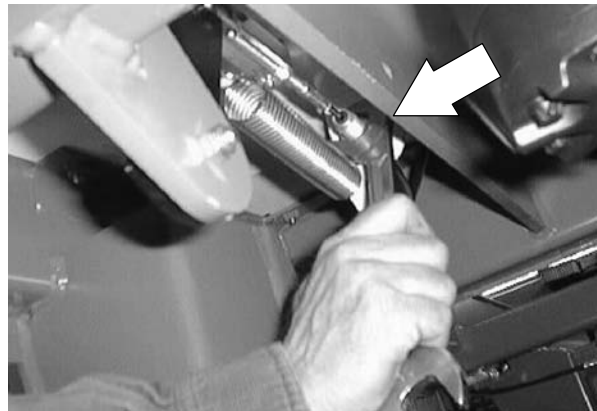

IF MORE ADJUSTMENT IS NEEDED:

1. Loosen the smaller jam nuts on the brake cable at the clevis assembly.

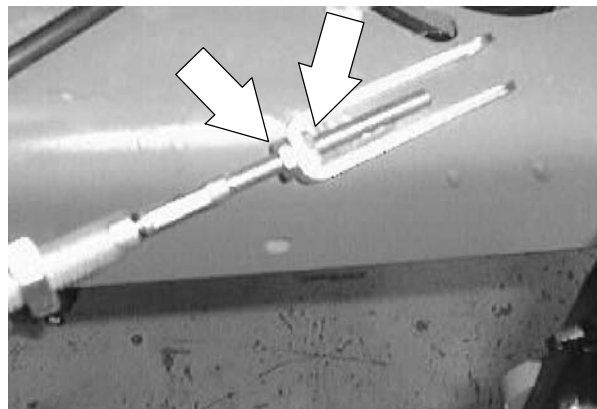

CHASSIS

2. Move the brake cable forward or backward in the clevis assembly for additional adjustment to the pedal throw.

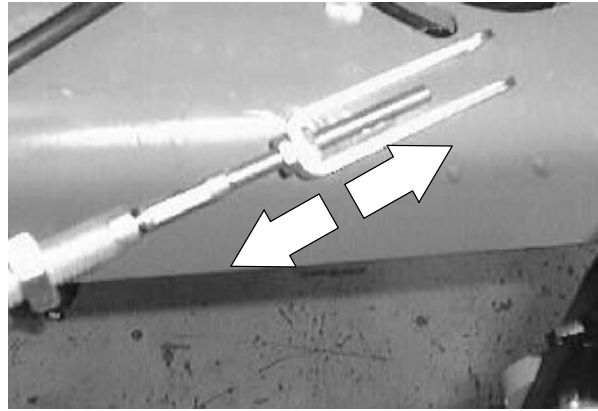

3. Retighten the two small jam nuts at the clevis assembly. Close the RH sweep brush door.

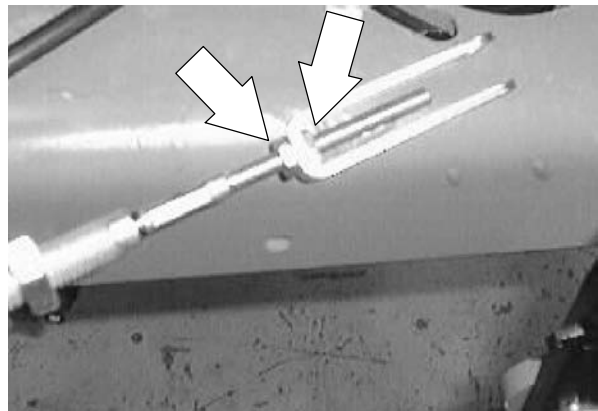

4. Go to the operators compartment and check the service brake pedal adjustment. The pedal should engage the service brakes with 1 inch of movement or less.

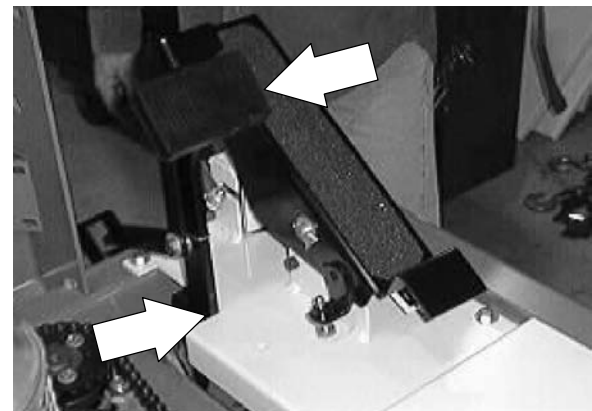

5. If needed, repeat adjustment procedure.

TO REPLACE BRAKE SHOES

FOR SAFETY: Before Leaving Or Servicing Machine; Stop On Level Surface, Set Parking Brake, Turn Off Machine And Remove Key.

1. Make sure the parking brake is not engaged. Open the RH sweep brush door.

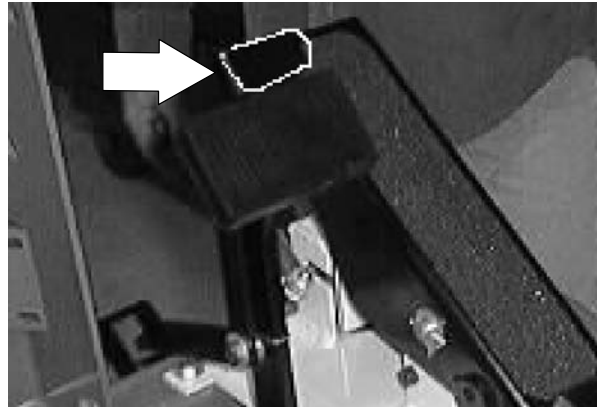

2. Go under the front, right corner of machine frame. Locate the brake cable clevis assembly.



3. Loosen the jam nuts on the brake cable at the clevis until the brake cable goes slack.

4. Jack up one rear corner of the machine. Place jack stands under machine.

FOR SAFETY: Block machine tires before jacking machine up. Jack machine up at designated locations only. Block machine up with jack stands.

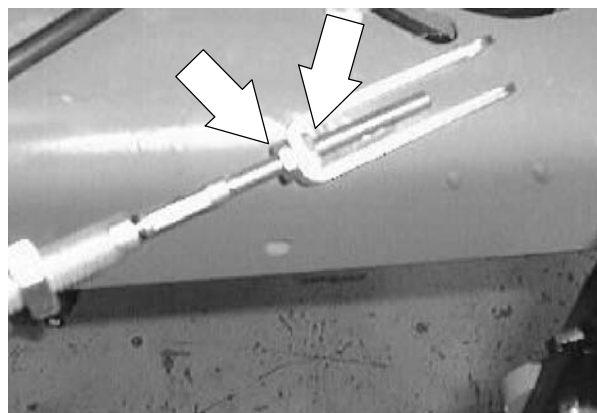

CHASSIS

5. Remove the hub cap from the center of the tire and wheel assembly.

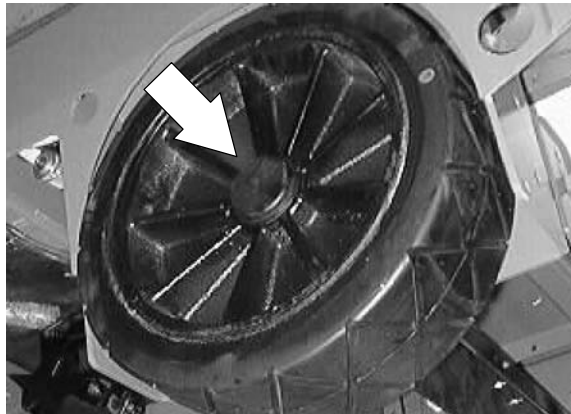

6. Remove the cotter pin, slotted nut, flat washer, and bearing cone.

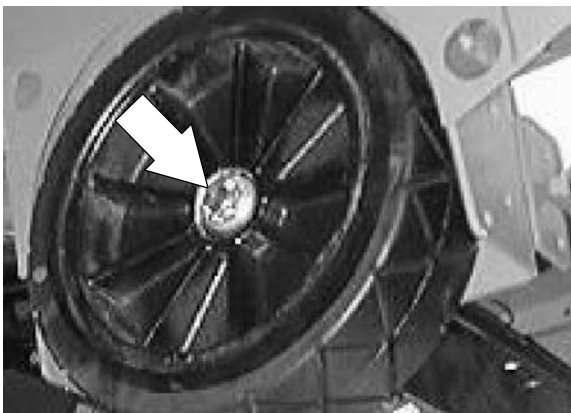

7. Remove the tire and wheel assembly from the machine.

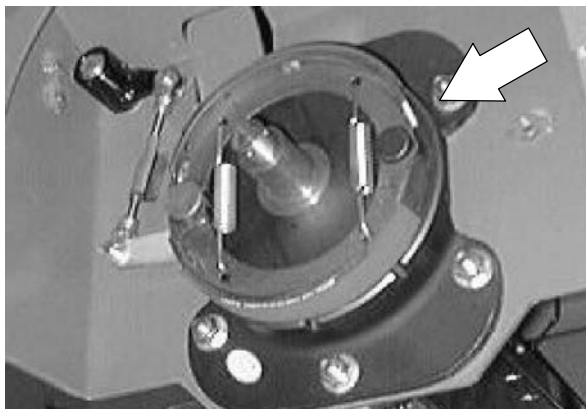

8. Remove the two springs holding the brake shoes together. Remove the old brake shoes.

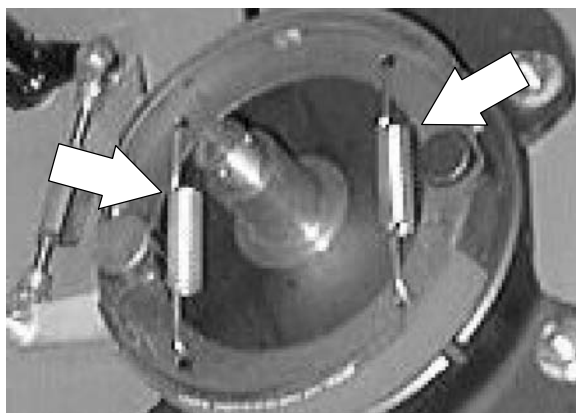

9. Position the new brake shoes on the brake mounting plate.

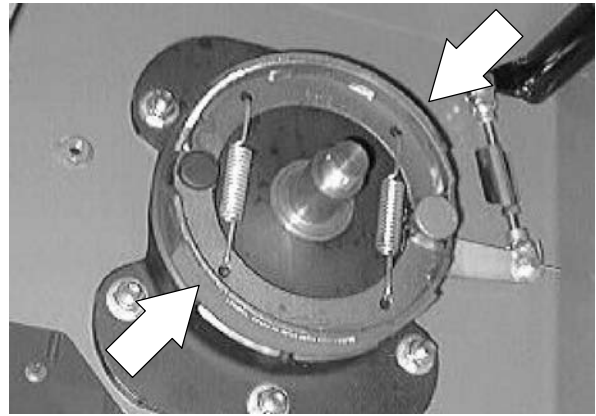

10. Reattach the two brake springs to the new brake shoes.

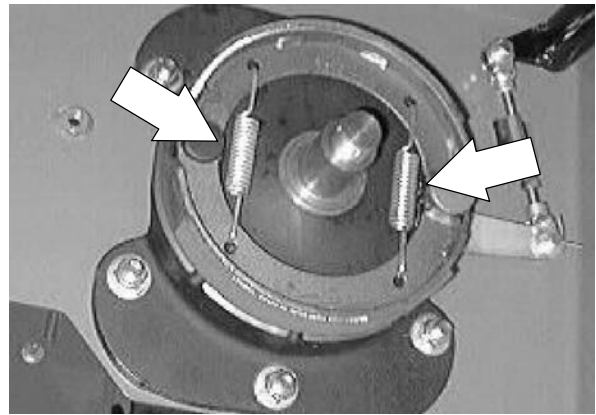

11. Pack the wheel bearings with Lubriplate EMB grease.

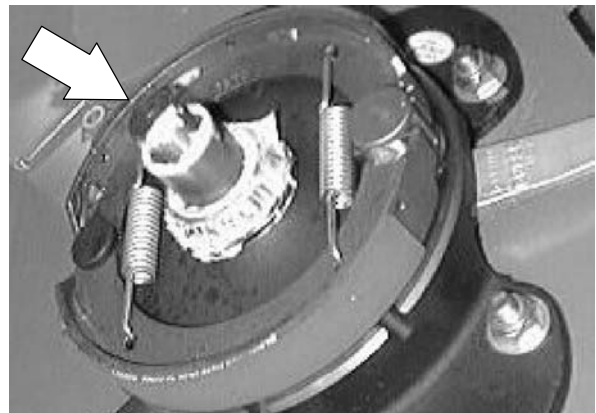

12. Slide the tire and wheel assembly on the axle.

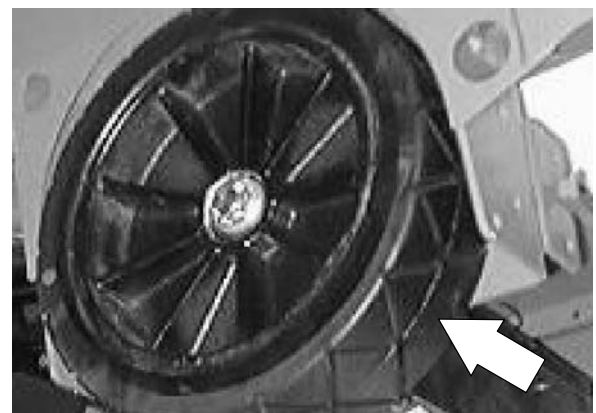

CHASSIS

13. Slide the outer bearing, flat washer and nut on the shaft.
14. Tighten nut with hand wrench until wheel binds, then back nut off to nearest hole.
15. Insert a new cotter pin through nut and hole.
16. Spin the tire and wheel assembly. The tire should spin freely.

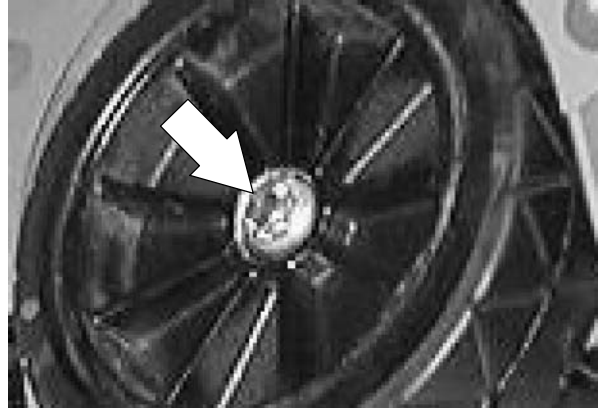

17. Reinstall the hub cap in the center of the wheel.

18. Lower the machine.

NOTE: Always replace brake shoes in sets.

19. Repeat the procedure on the other wheel.

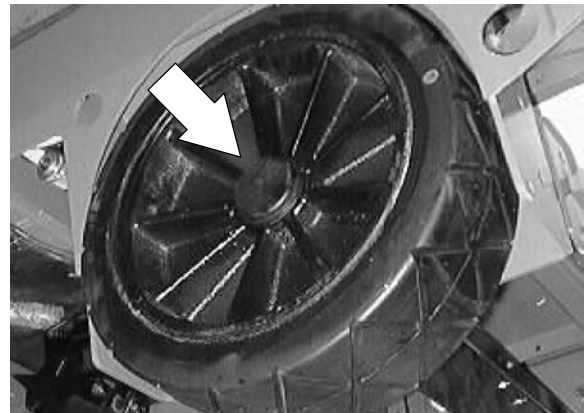

20. Adjust the brake cable clevis until the brake cable is tight or until the brake pedal travels 25-50 mm (1-2 in) before engaging brakes.

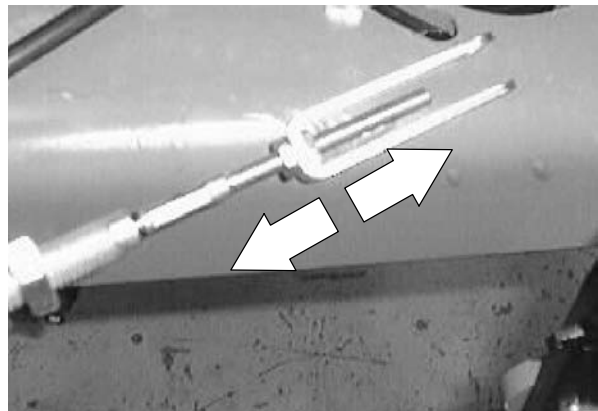

21. Tighten the brake cable jam nuts at the clevis. Close the RH sweep brush door.

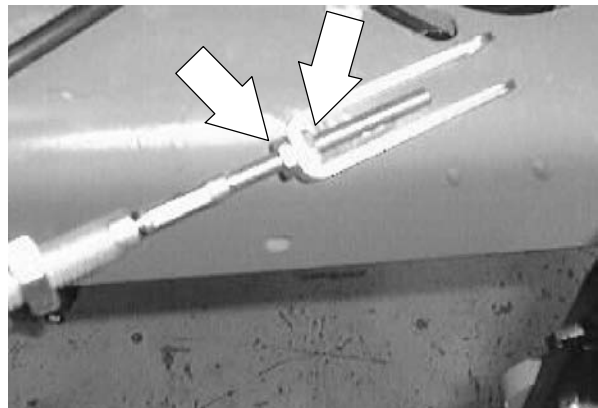

22. Operate the machine and check the brakes for proper operation.

REAR TIRES AND WHEELS

The 8300 rear tires are semi-pneumatic.

Inspect the rear wheel bearings for seal damage, and repack and adjust every 1600 hours of operation. Use Lubriplate EMB grease (TENNANT part no. 01433-1).

TO REPACK REAR WHEEL BEARINGS

FOR SAFETY: Before Leaving Or Servicing Machine; Stop On Level Surface, Set Parking Brake, Turn Off Machine And Remove Key.

1. Make sure the parking brake is not engaged. Open the RH sweep brush door.

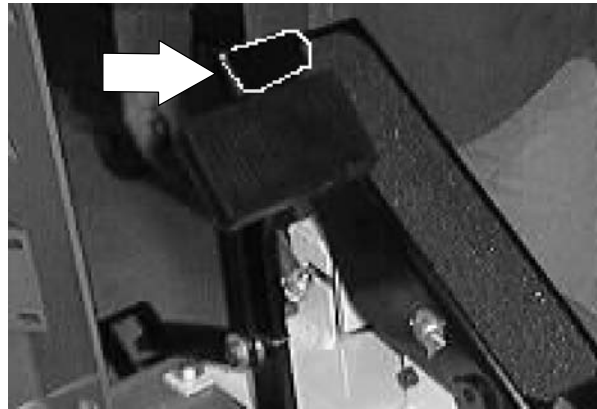

2. Go under the front, right corner of machine frame. Locate the brake cable clevis assembly.



3. Loosen the jam nuts on the brake cable at the clevis until the brake cable goes slack.

4. Jack up one rear corner of the machine. Place jack stands under machine.

FOR SAFETY: Block machine tires before jacking machine up. Jack machine up at designated locations only. Block machine up with jack stands.

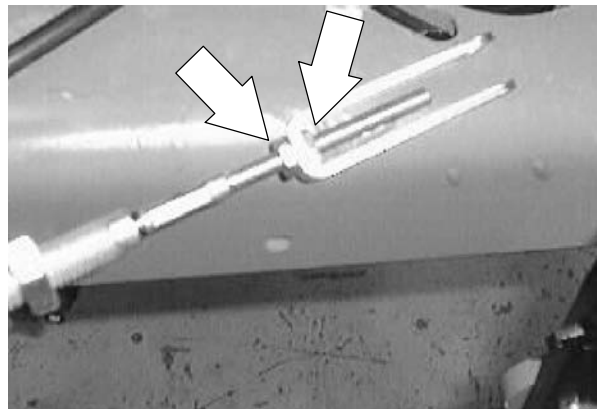

CHASSIS

5. Remove the hub cap from the center of the tire and wheel assembly.

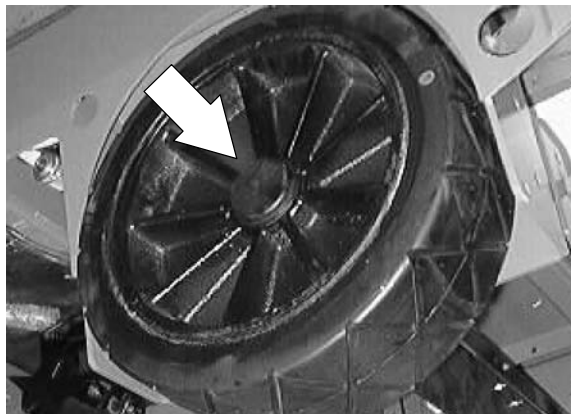

6. Remove the cotter pin, slotted nut, flat washer, and bearing cone.

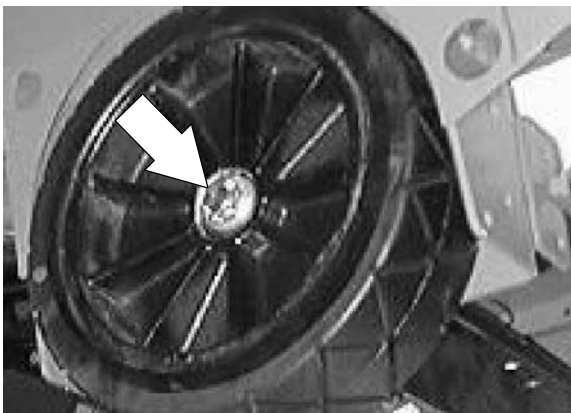

7. Remove the tire and wheel assembly from the machine.

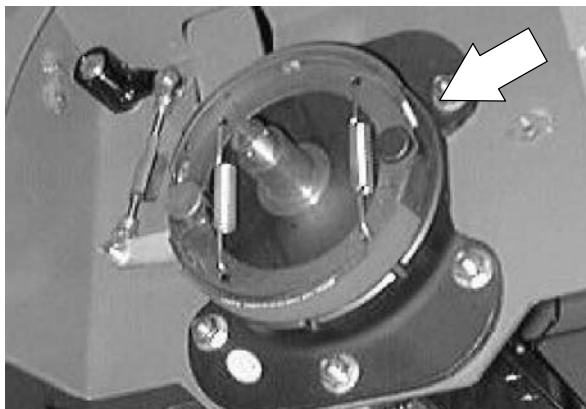

8. Pack the wheel bearings with Lubriplate EMB grease.

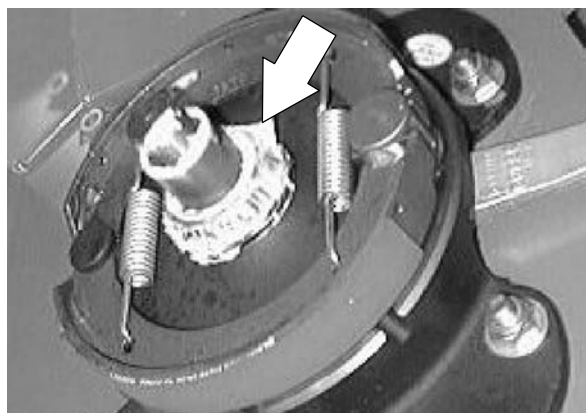

9. Slide the outer bearing, flat washer and nut on the shaft.
10. Tighten nut with hand wrench until wheel binds, then back nut off to nearest hole.
11. Insert a new cotter pin through nut and hole.
12. Spin the tire and wheel assembly. The tire should spin freely.

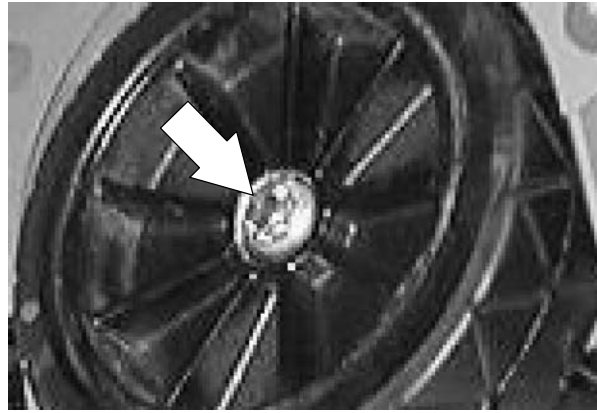

13. Reinstall the hub cap in the center of the wheel.
14. Lower the machine.

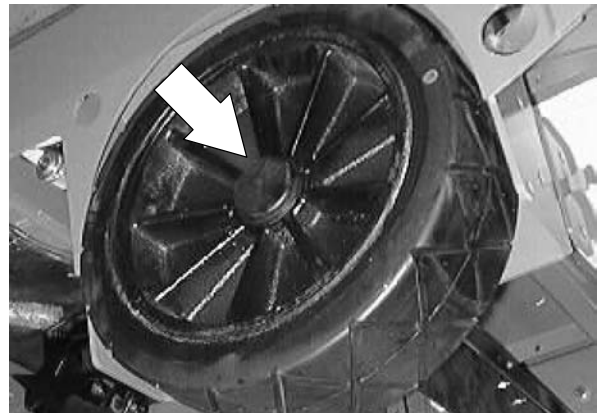

NOTE: Always replace brake shoes in sets.

15. Repeat the procedure on the other wheel.

16. Adjust the brake cable clevis until the brake cable is tight or until the brake pedal travels 25–50 mm (1–2 in) before engaging brakes.

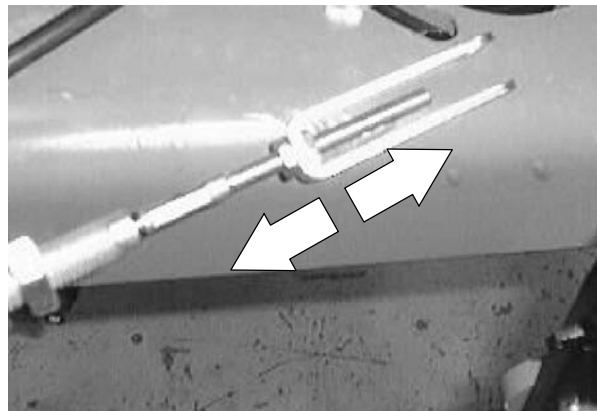

17. Tighten the brake cable jam nuts at the clevis. Close the RH sweep brush door.

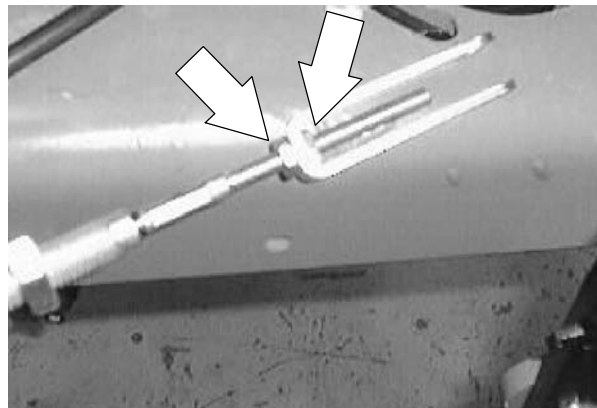

18. Operate the machine and check the rear wheels for proper operation.

FRONT TIRE AND WHEEL, AND WHEEL DRIVE SUPPORT

FRONT WHEEL SUPPORT AND BEARING

FOR SAFETY: Before Leaving Or Servicing Machine; Stop On Level Surface, Set Parking Brake, Turn Off Machine And Remove Key.

The front wheel support bearing allows the gearbox and front wheel assembly to rotate freely. Raise the machine so the front wheel is off the ground. Fill one grease fitting with Lubriplate EMB grease (TENNANT Part No. 01433-1) while rotating the gearbox from stop to stop. Fill the second grease fitting while rotating the gearbox back to the original position. The bearing cavity is full when grease comes out of the fittings or out of the top seal. Apply the lubricant after every 200 hours of operation, or after steam cleaning the gearbox area.

Torque the front wheel nuts to 122 to 150 Nm (90 to 110 ft lb) after the first 50-hours of operation, and every 800 hours there after.

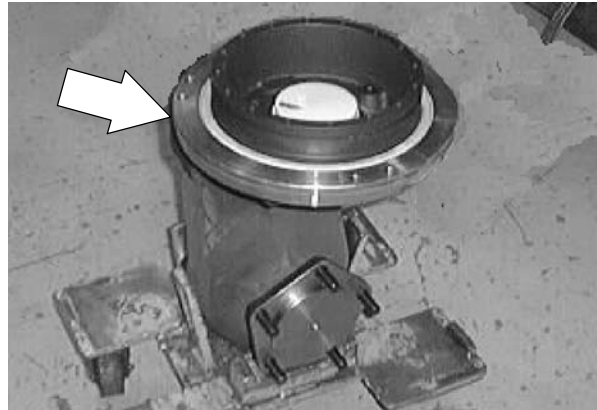

PROPELLING GEARBOX

The propelling gearbox transfers power from the propelling motor to the front wheel. It is lubricated with SAE 90 weight gear lubricant. Check the lubricant level after every 100 hours of operation. Change the gear lubricant and the drain and fill-level plug seals after the first 50 hours of operation, and then after every 1000 hours of operation.

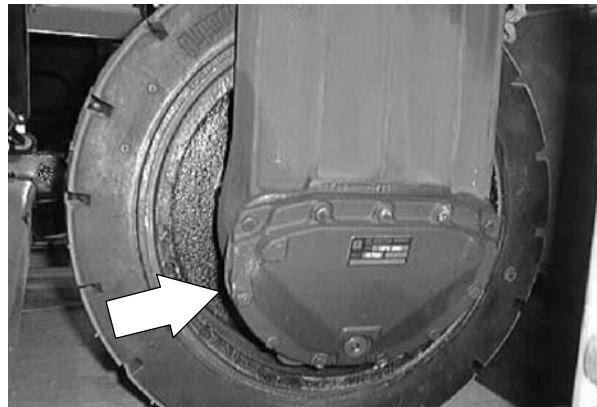

TO REPLACE FRONT DRIVE GEAR BOX

FOR SAFETY: Before Leaving Or Servicing Machine; Stop On Level Surface, Set Parking Brake, Turn Off Machine And Remove Key.

1. Engage the parking brake, block the rear tires.
2. Jack up the front of the machine. Use jack stands to support the machine.

FOR SAFETY: Block machine tires before jacking machine up. Jack machine up at designated locations only. Block machine up with jack stands.

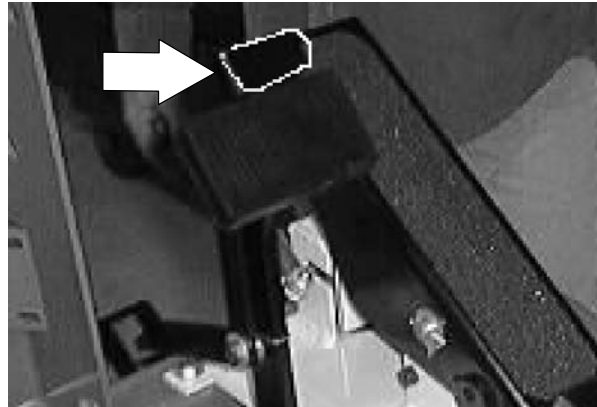

3. Open the cover and side door.

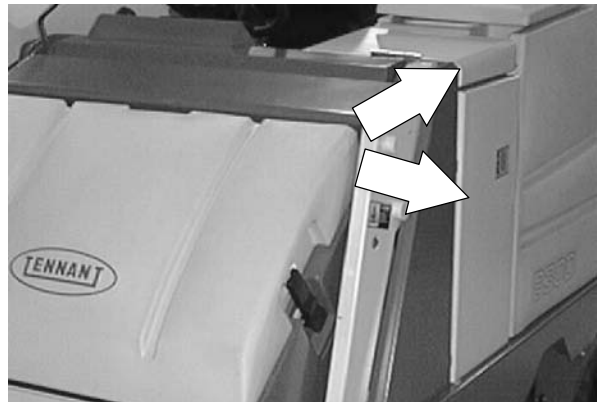

4. Open the battery cover and un-plug the battery connector from the machine.

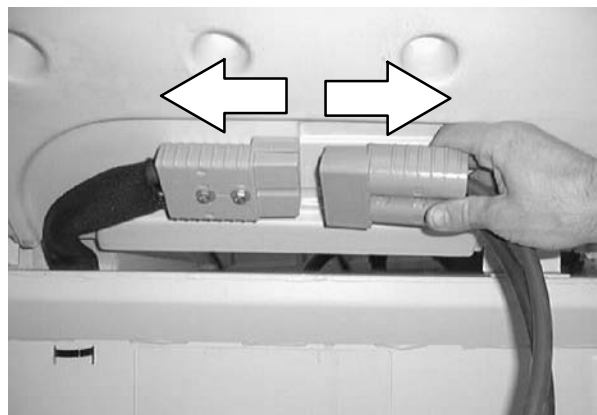

CHASSIS

5. Remove the detergent tank and control panel cover from the machine.

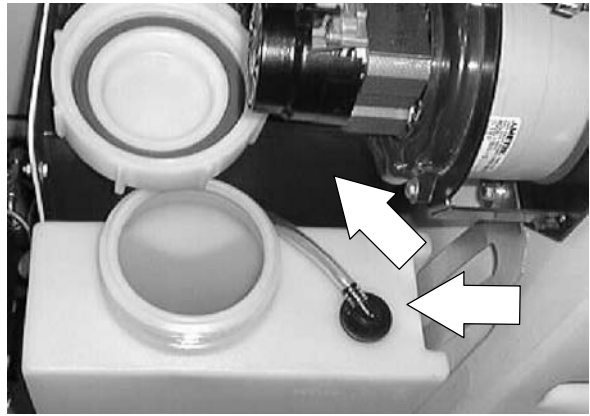

6. Remove the plastic drive motor cover.

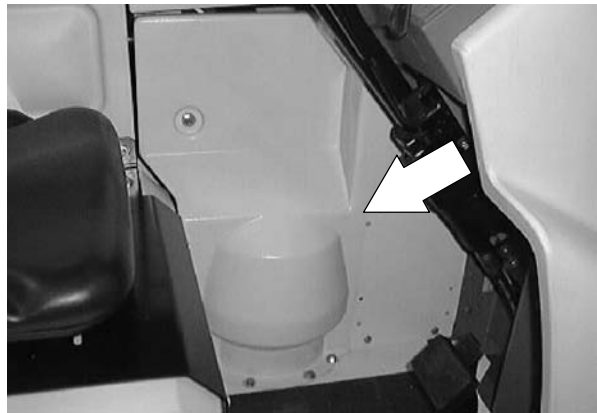

7. Remove the three hex screws holding the main electrical panel to the machine frame.

NOTE: Move the main panel back far enough so there is clearance to remove the large steering sprocket from the drive assembly.

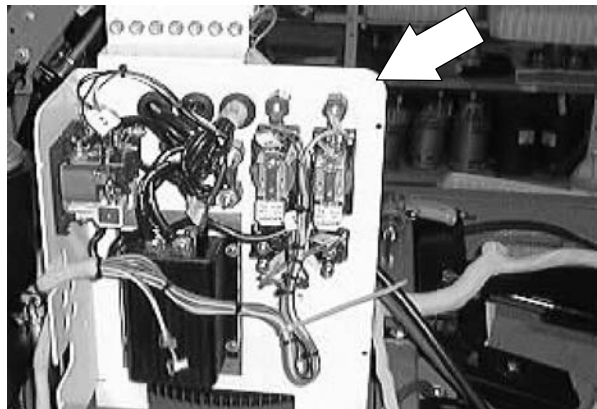

8. Remove the hardware holding the smaller electrical panel to the left side of the steering support column.

NOTE: Move the small panel back far enough so there is clearance to remove the large steering sprocket from the drive assembly.

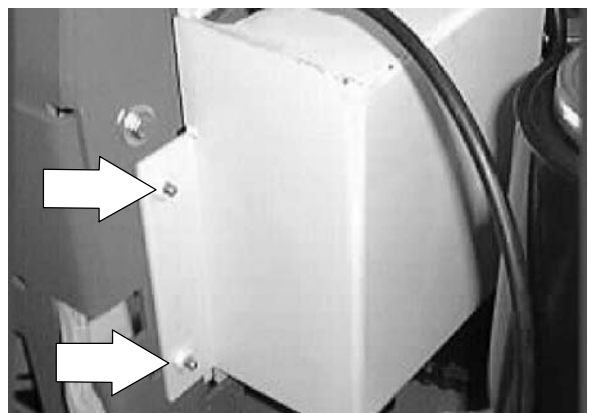

9. Remove the inside floor plate.

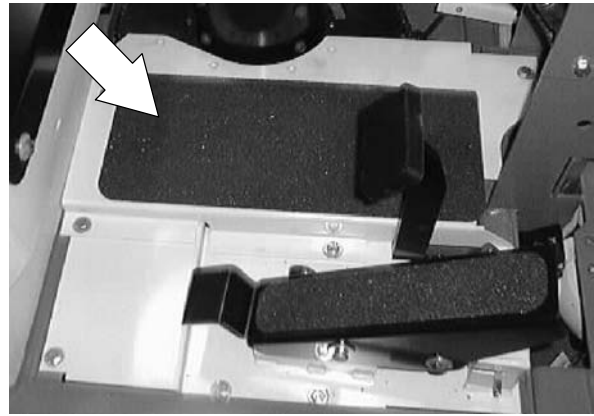

10. Mark and disconnect the four electrical cables leading to the drive motor.



11. Remove the front tire and wheel assembly from the drive motor hub.



12. Remove the three M8 socket head cap screws holding the electric drive motor to the drive gear box.

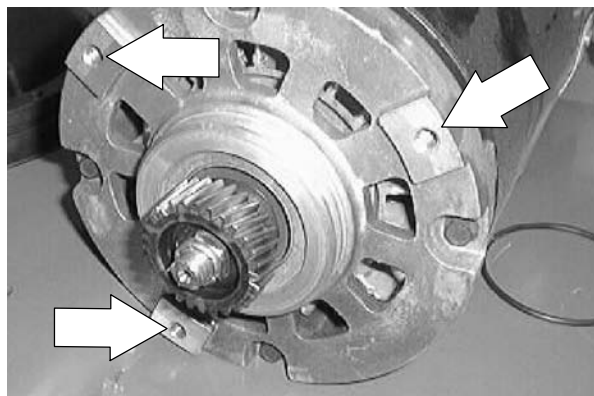

CHASSIS

13. Pull the drive motor straight up and out of the drive gear box. Remove it from the machine.

NOTE: Be careful not to loose the rubber o-ring that is on the bottom of the motor.

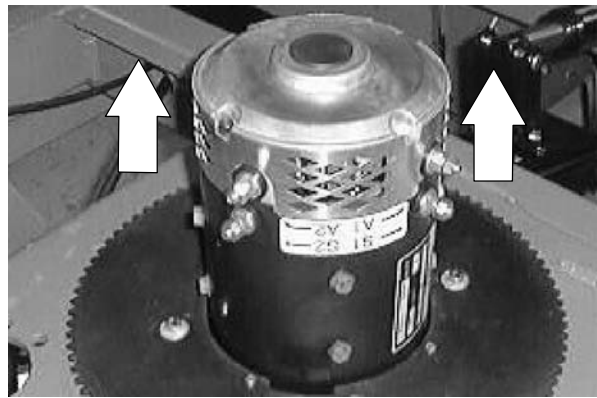

14. Place a drain pan under the drive gear box and drain the gear lube. Replace the plug.

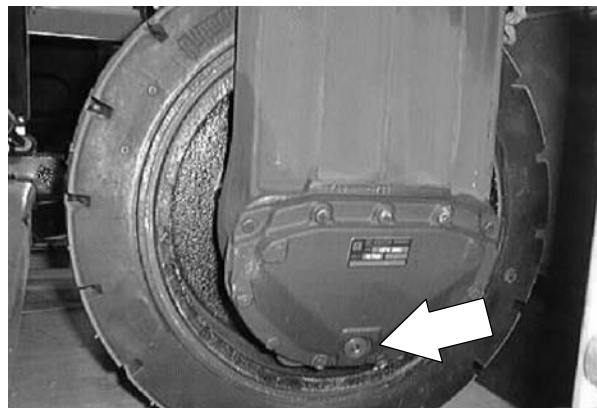

15. Loosen the hardware holding the hydraulic steering motor to the machine frame.

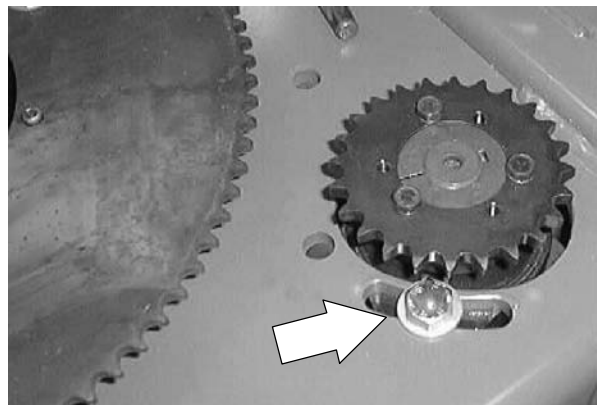

16. Push the steering motor in until there is slack in the steering chain.

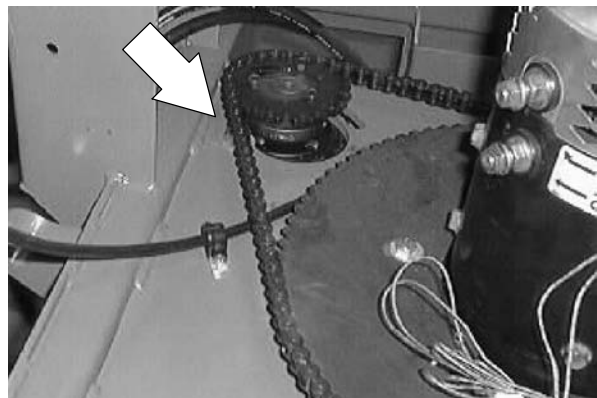

- Drop the chain off the steering and motor sprockets.

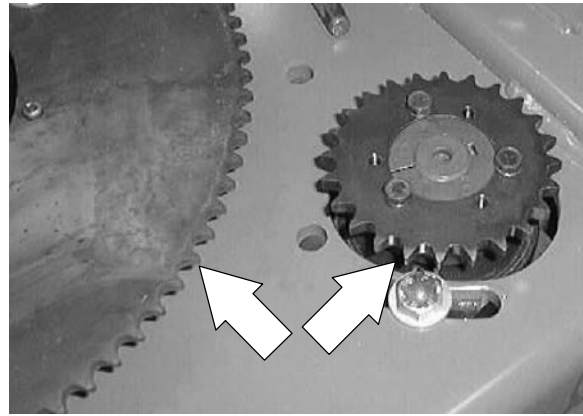

- Remove the four hex screws holding the sprocket clips to the bottom of the steering sprocket. Lift the sprocket off the gear box upper ring.

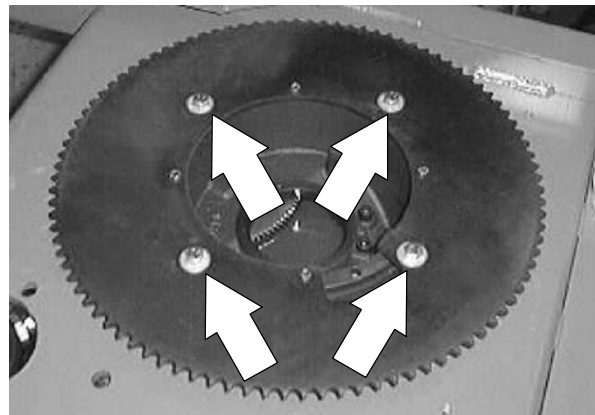

A floor jack, transmission jack or some other lifting device must be placed under the drive gear box at this point to help in the removal.



- Remove the six hex screws holding the drive gear box to the machine frame.

CAUTION: *The drive gear box is very heavy and tippy when the mounting hardware is removed!*

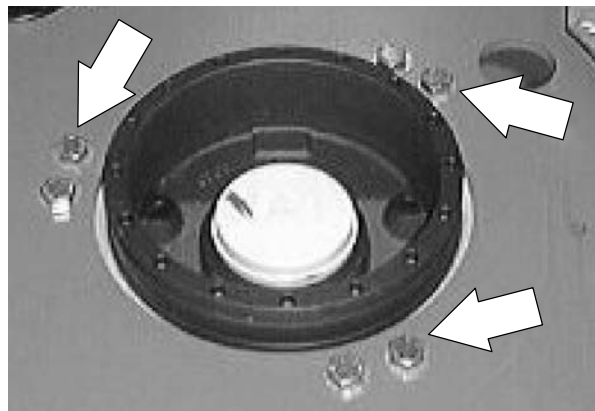

CHASSIS

20. Drop the drive gear box down and pull it out the front of the machine.
21. Make the necessary repairs on the drive gear box or prepare a new gear box for installation.

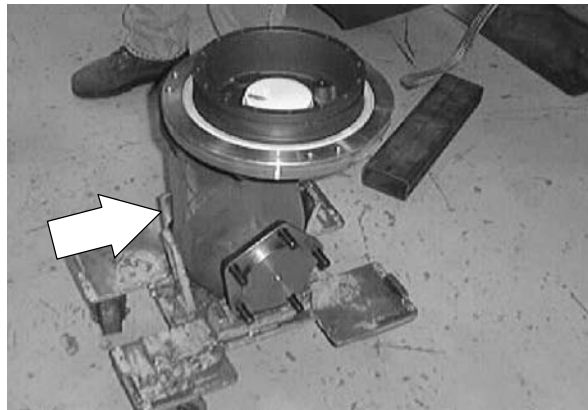

22. Place the gear box on the lifting device and position it back under the machine.
23. The gear box must be stood straight up and jacked into position. Be careful not to let it fall over possibly damaging the gear box or causing injury.



24. The six holes in the drive gear box upper ring must be lined up with the four holes in the machine frame.
25. Reinstall the hex screws using 242 blue loctite and tighten to 64 - 83 Nm (50 - 60 ft lb).

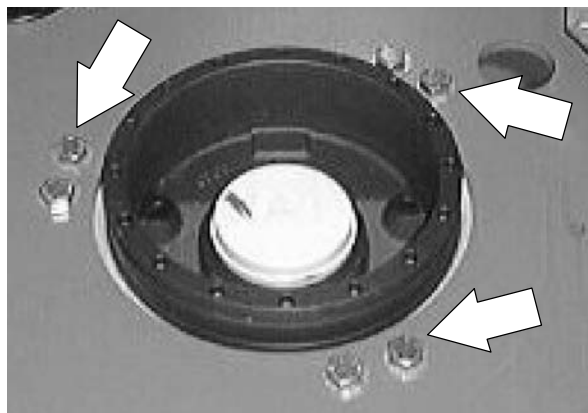

26. Fill the gear box case through the large hole on top, with .75 gallon of 90 weight gear lube.



NOTE: Before the motor is reinstalled, mark the position of the threaded mounting holes in the bottom of the motor. Go far enough up the side of the motor so the mark can be seen when the motor is positioned in the drive gear box.

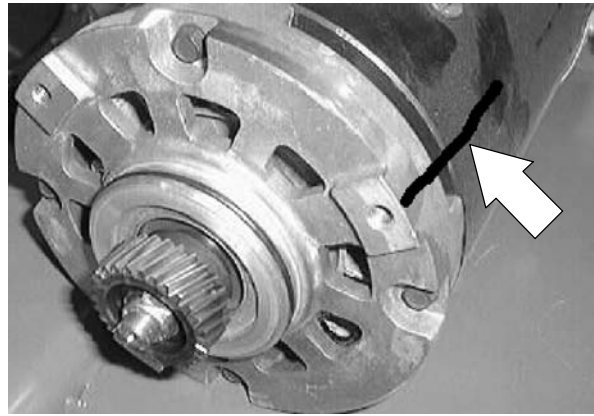

27. Position the electric drive motor back on the gear box housing. Make sure the electric cable studs are pointing towards the LH side of the machine.

NOTE: Make sure the O-ring is installed on the bottom of the motor.

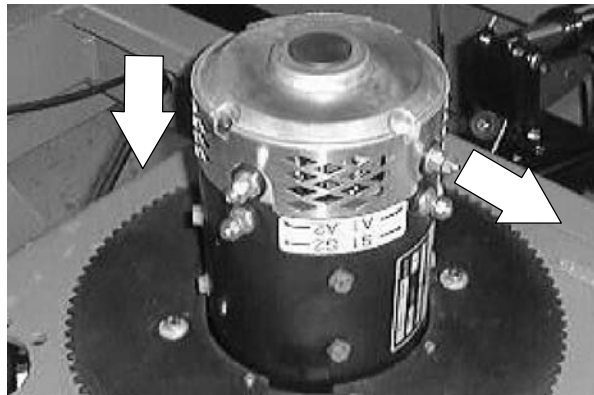

28. Reinstall the three M8 socket head cap screws holding the electric drive motor to the drive gear box. Tighten to 26 - 34 Nm (20 - 26 ft lb).

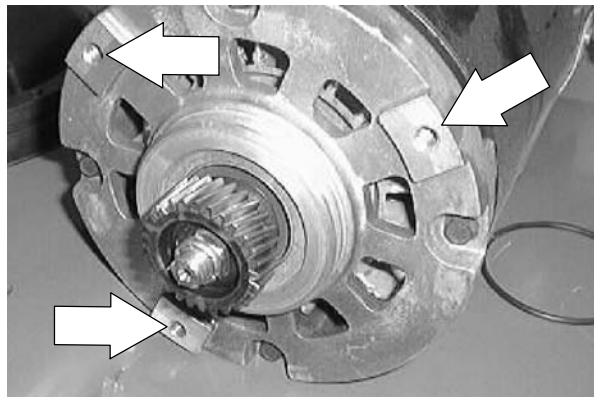

29. Install front tire. Tighten nuts to 122-150 Nm (90-110 ft lb).



CHASSIS

30. Position the steering sprocket back on the top of the drive gear box. Line up the pins with the holes in the sprocket. Make sure to have the gear box pointing straight ahead with the tire mounting studs pointing towards the LH side of the machine.
31. Reinstall the four sprocket clips, M8 hex screws and washers. Tighten to 18 - 24 Nm (15 - 20 ft lb).
32. Place the steering chain back on the large steering sprocket.

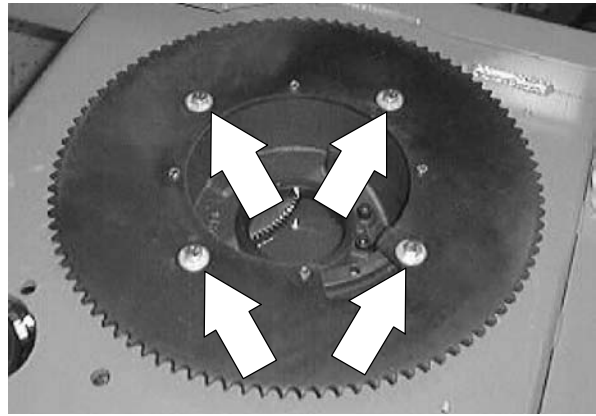

33. Use a pry bar to move the hydraulic steering motor away from the large sprocket until the chain is tight. Tighten the motor mounting hardware to 18 - 24 Nm (15 - 20 ft lb).

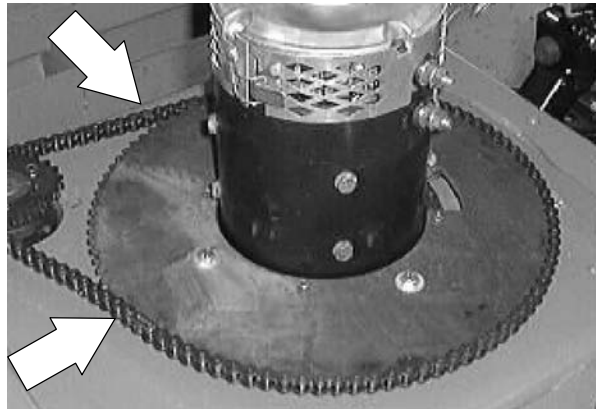

NOTE: The tension of the chain should be checked after the first 50 hours of operation and every 200 hours thereafter. The deflection should be 0.12 to 0.25 in (3 to 6 mm) between the steering sprocket and the idler sprocket when the steering wheel is turned the tightest position either direction.

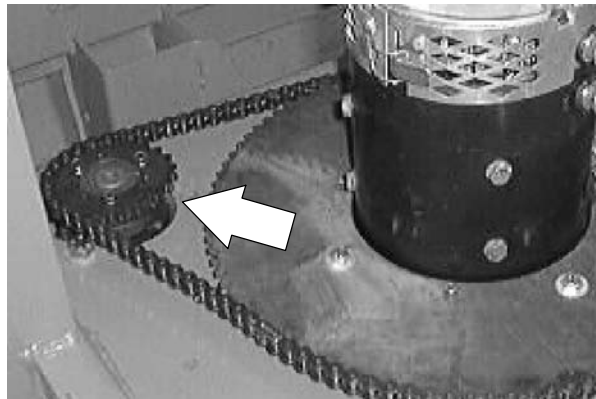

34. Reconnect the four electrical cables going to the drive motor. See the schematic in the ELECTRICAL section of this manual.



35. Move the smaller electrical panel into position on the left side of the steering column and reinstall the hardware. Tighten to 11 - 14 Nm (7 - 10 ft lb).

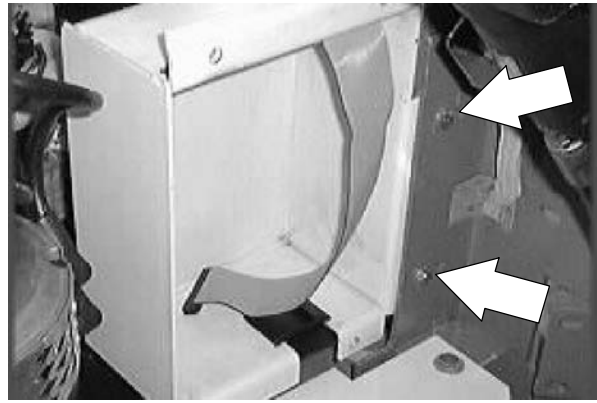

36. Move the larger electrical panel into position and reinstall the three hex screws. Tighten to 18 - 24 Nm (15 - 20 ft lb).

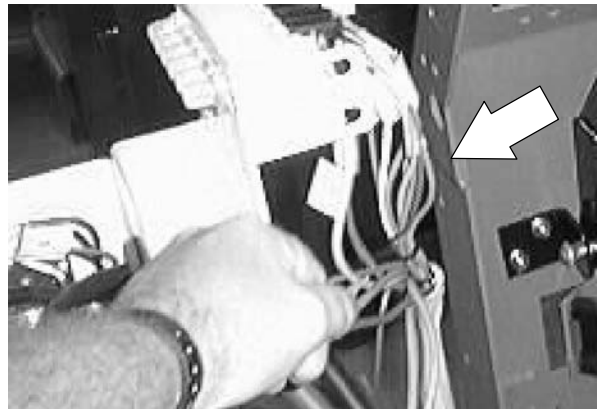

37. Reinstall the control panel cover and detergent tank.

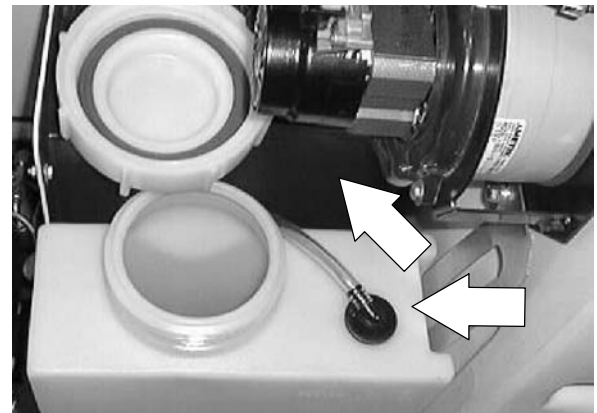

38. Reinstall the inside floor plate.

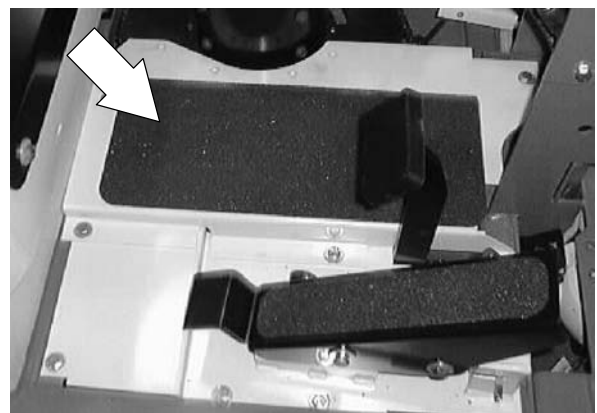

CHASSIS

39. Reinstall the plastic drive motor cover.

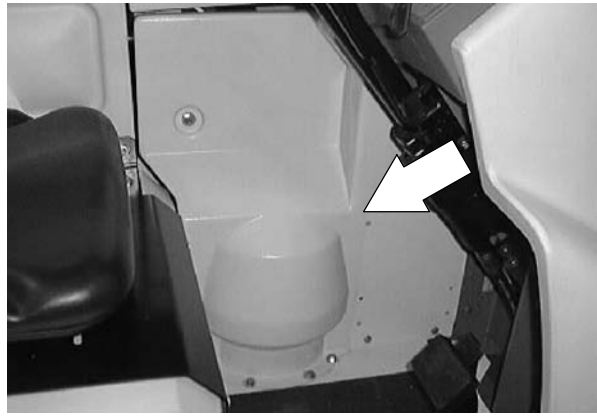

40. Plug in the battery connector. Close the battery cover.

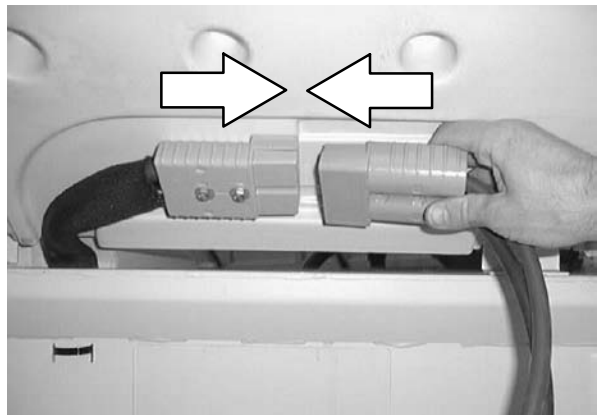

41. Close the cover and side door.

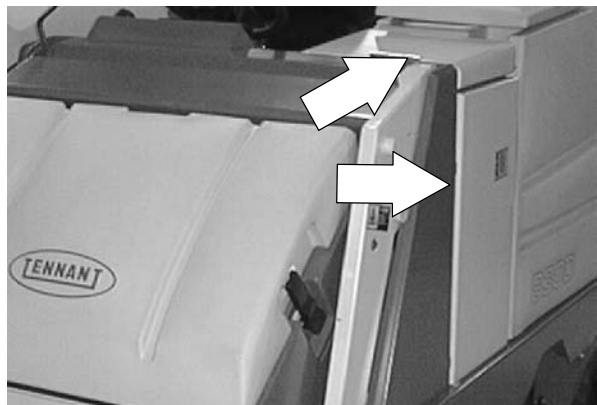

42. Lower the machine to the ground and check the gear box for proper operation.

STEERING

STEERING CHAIN

The steering chain controls the machine steering. The tension of the chain should be checked after the first 50 hours of operation and every 200 hours there after. The deflection should be 0.12 to 0.25 in (3 to 6 mm) between the large steering sprocket and the idler /motor sprocket when the steering wheel is turned the tightest position either direction.

TO ADJUST STEERING CHAIN TENSION

FOR SAFETY: Before Leaving Or Servicing Machine; Stop On Level Surface, Set Parking Brake, Turn Off Machine And Remove Key.

1. Remove the plastic drive motor cover.

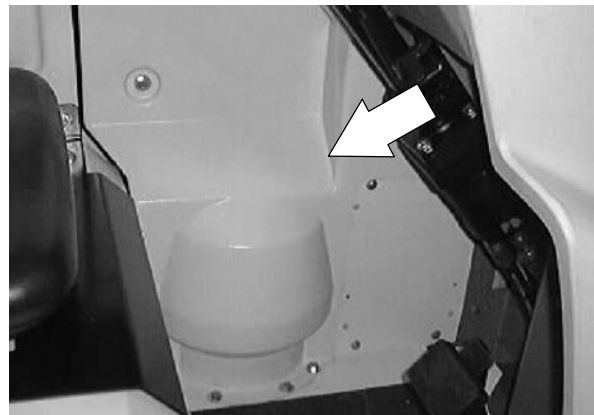

2. Remove the inside floor plate.

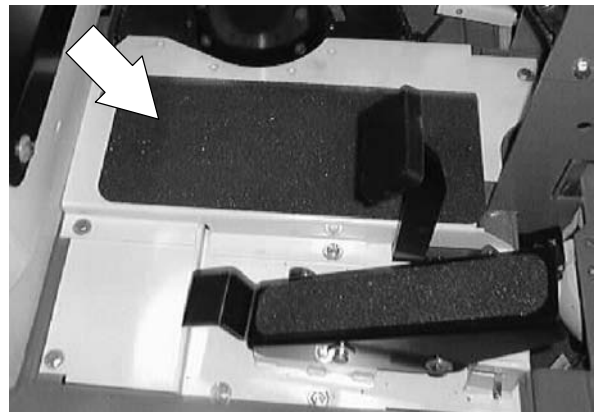

CHASSIS

3. Loosen the hardware holding the hydraulic steering motor to the machine frame.

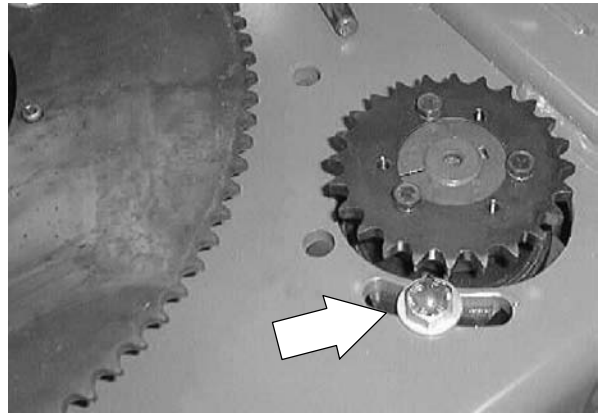

4. Use a pry bar to move the hydraulic steering motor away from the large sprocket until the chain is tight. Tighten the motor mounting hardware to 37 - 48 Nm (26 - 34 ft lb).

NOTE: The tension of the chain should be checked after the first 50 hours of operation and every 200 hours thereafter. The deflection should be 0.12 to 0.25 in (3 to 6 mm) between the steering sprocket and the idler sprocket when the steering wheel is turned the tightest position either direction.

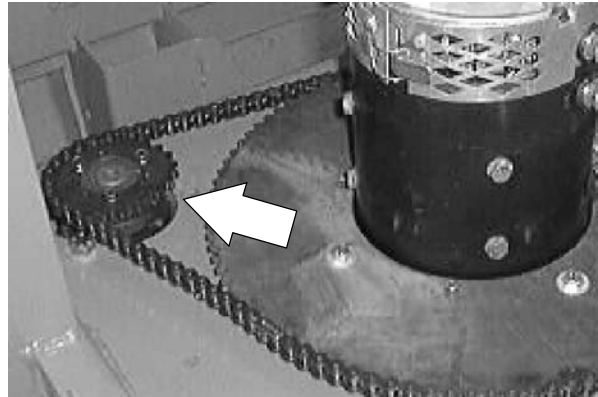

5. Reinstall the inside floor plate.

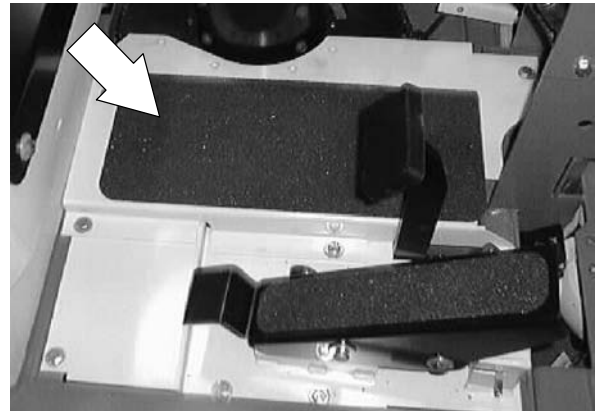

6. Reinstall the plastic drive motor cover.



7. Lower the machine to the ground and check the steering for proper operation.

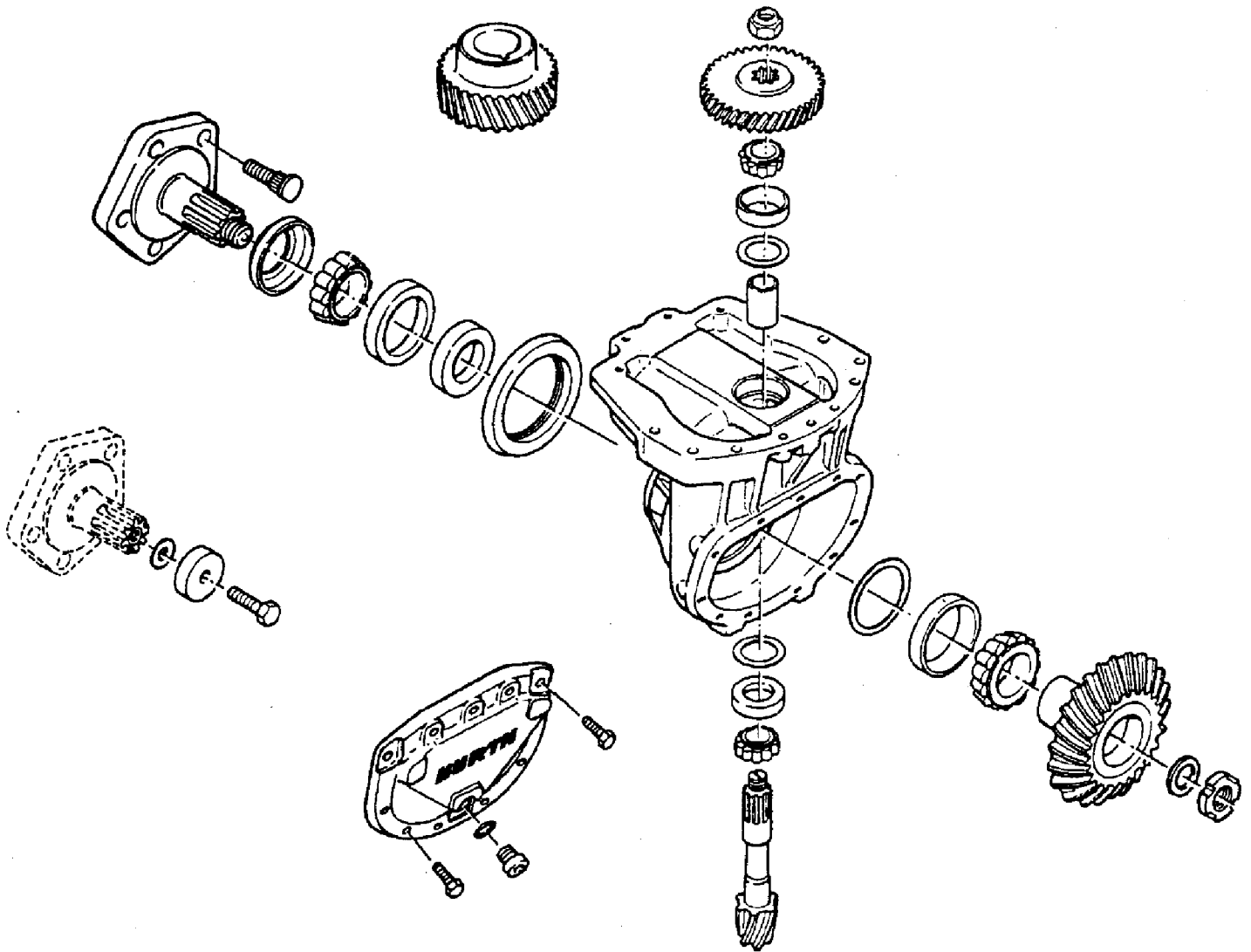

HURTH GEARBOX EXPLODED VIEW (LOWER SECTION)

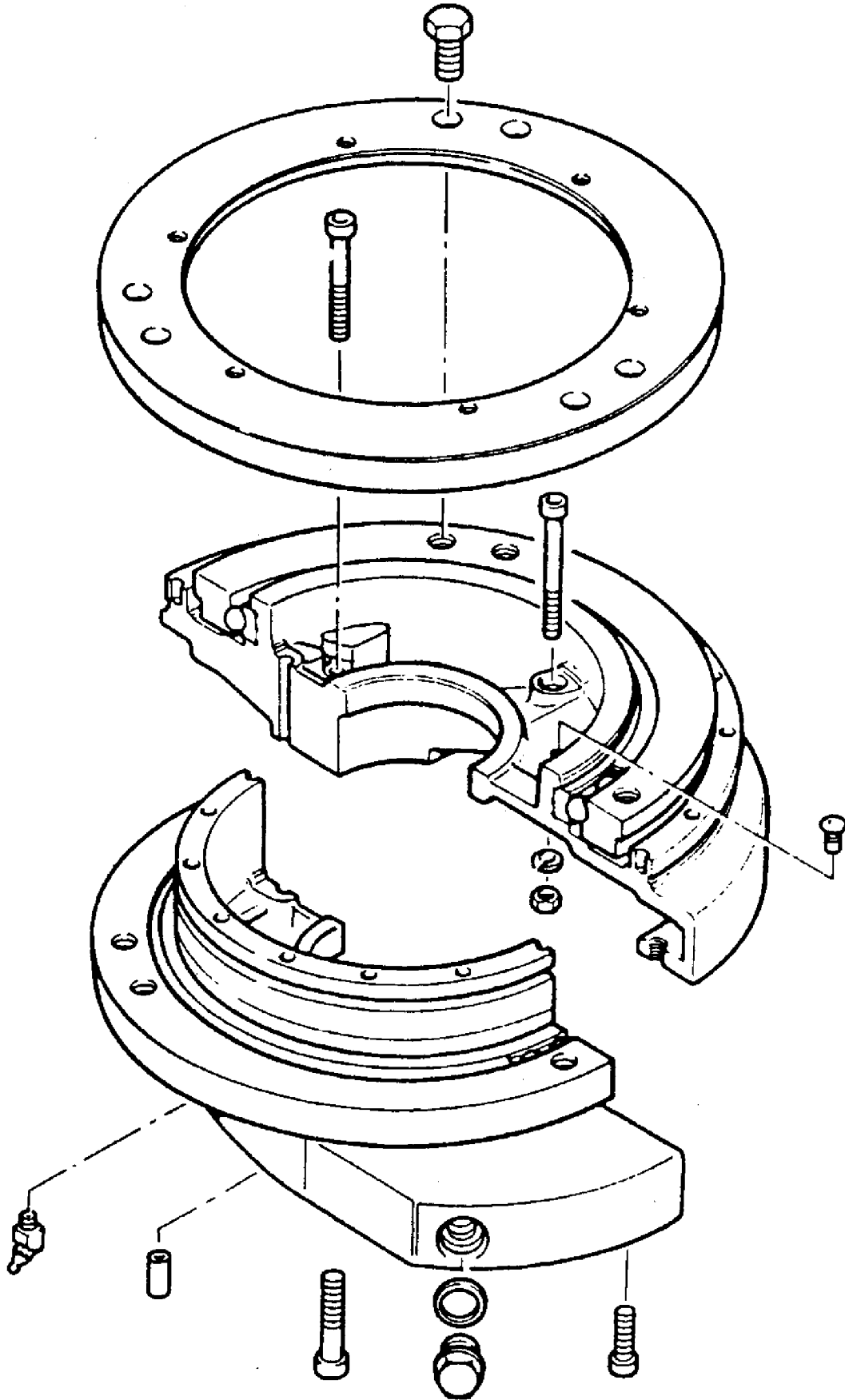

HURTH GEARBOX EXPLODED VIEW (UPPER SECTION)

CONTENTS

	Page		Page
INTRODUCTION	3-3	VACUUM FAN	3-77
DEBRIS HOPPER	3-4	HOPPER VACUUM FAN SEAL ...	3-77
HOPPER ADJUSTMENTS	3-4	TO REMOVE VACUUM FAN	
TO ADJUST HOPPER PRIMARY		HOUSING	3-78
ROLL OUT CHAIN	3-5	TO INSTALL VACUUM FAN	
TO REPLACE HOPPER PRIMARY		ASSEMBLY	3-81
ROLL OUT CHAIN	3-8	TO REPLACE VACUUM FAN	
TO ADJUST HOPPER SECONDARY		IMPELLER BEARINGS	3-84
ROLL OUT CHAIN	3-12	TO TENSION VACUUM FAN BELT	3-89
TO REPLACE HOPPER SECONDARY		MACHINE SWEEPING	
ROLL OUT CHAIN	3-15	TROUBLESHOOTING	3-91
HOPPER DUST FILTER	3-19		
TO REPLACE HOPPER DUST			
FILTER	3-19		
MAIN BRUSH	3-22		
TO REPLACE MAIN SWEEP			
BRUSH	3-22		
TO REPLACE CYLINDRICAL			
ELEVATOR	3-25		
TO CHECK AND ADJUST MAIN			
BRUSH PATTERN	3-28		
TO CHECK MAIN BRUSH			
PATTERN	3-28		
TO ADJUST MAIN BRUSH			
PATTERN	3-28		
TO ADJUST MAIN BRUSH			
LEVELNESS	3-29		
MAIN BRUSH DRIVE BELTS	3-30		
TO REPLACE MAIN BRUSH			
PRIMARY DRIVE BELT	3-30		
TO REPLACE MAIN BRUSH			
SECONDARY DRIVE BELT ...	3-34		
TO REPLACE MAIN BRUSH IDLER			
PLUG BEARING	3-38		
TO REPLACE ROTARY ELEVATOR			
IDLER PLUG	3-43		
TO REPLACE MAIN BRUSH TWO			
GROOVE SHEAVE BEARINGS	3-47		
TO REPLACE MAIN BRUSH			
LIFT CABLE	3-53		
TO REPLACE LARGE DEBRIS SKIRT			
AUTOMATIC LIFT CABLE	3-61		
SIDE SWEEPING BRUSH	3-69		
TO ADJUST SIDE BRUSH PATTERN	3-70		
TO ADJUST SIDE BRUSH PATTERN			
SIDE TO SIDE	3-70		
TO ADJUST SIDE BRUSH PATTERN			
FRONT TO BACK	3-70		
TO REPLACE SIDE BRUSH	3-71		
SKIRTS AND SEALS	3-73		
DEBRIS SKIRT	3-73		
TO REPLACE DEBRIS SKIRT ...	3-73		
RECIRCULATION SKIRTS	3-75		
TO REPLACE REAR SKIRT	3-75		
HOPPER SEALS	3-76		

INTRODUCTION

The Hi-dump sweeper assembly on the 8300 gives the machine ability to pick up debris and dump it into a container. The sweeper assembly is mounted to the front of the machine. All components can be serviced with the sweeper mounted to the front of the machine. The assembly contains upper and lower main brushes, side brush, vacuum fan, hopper, dust filter, electric/hydraulic power unit, and hopper lift cylinder.

The side brush sweeps debris into the path of the main brush which sweeps debris into the hopper. Periodically empty the debris hopper as it fills with debris.

There is a large debris flap at the front of the main brush that can be lifted manually to allow large debris pass under the skirts and into the path of the main brush where it can be deposited into the hopper.

All adjustments have been made at the factory and require no regular maintenance. If the hopper components are repaired or replaced, some components may need to be readjusted for best performance.



SWEEPING

DEBRIS HOPPER

The debris hopper holds the material swept up by the main and side brush. The 8300 hopper is unique in that only the hopper lifts and dumps, the dust filter and shaker assembly are stationary. The side brushes also are stationary when the hopper is lifted and dumped.



HOPPER ADJUSTMENTS

FOR SAFETY: Before Leaving Or Servicing Machine; Stop On Level Surface, Set Parking Brake.

There are two adjustments relating to the hopper; the first is a pair of lift arm stops located on each side of the sweeper frame, the second is the roll-out chain adjustment.

The lift arms should be resting on the lift arm stops when the hopper is in the lowered position, if not, adjust the stop up until they contact the bottom of the lift arms.

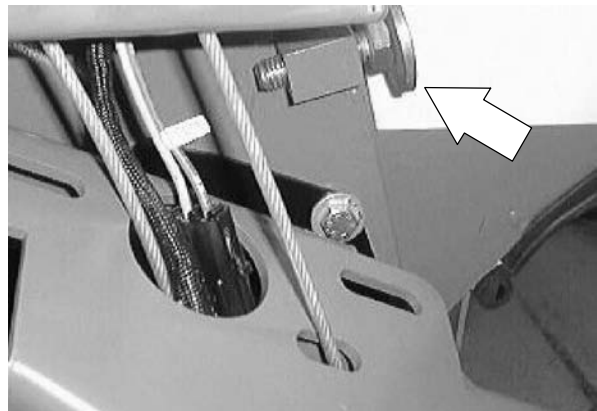

The two lift arm stops are used to limit how far the lift arms drop into the sweeper frame. The roll-out chain determines how far the hopper rolls out for dumping and how far the hopper rolls into the dust seal on the front of the filter housing.

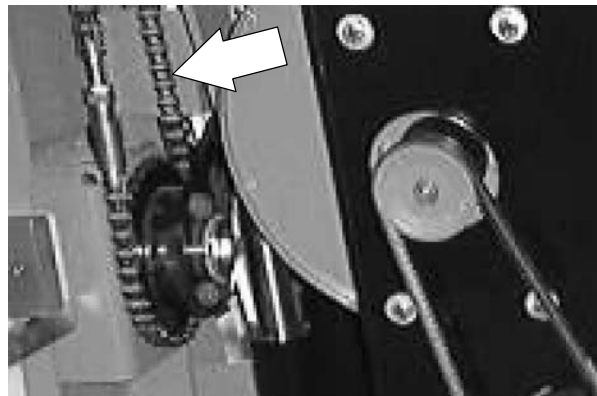

TO ADJUST HOPPER PRIMARY ROLL OUT CHAIN

FOR SAFETY: Before Leaving Or Servicing Machine; Stop On Level Surface, Set Parking Brake.

1. Raise the rear cover and unplug the battery connector.

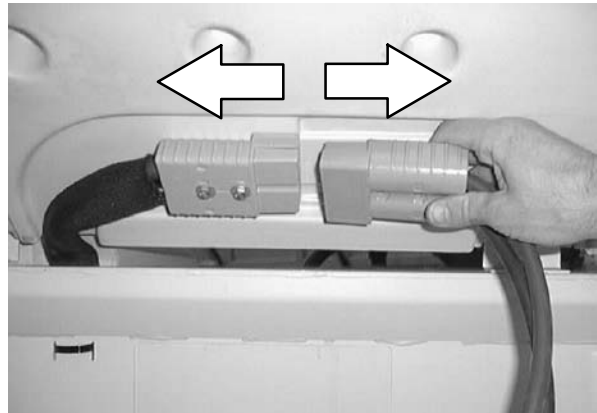

2. Open the top cover and side door.

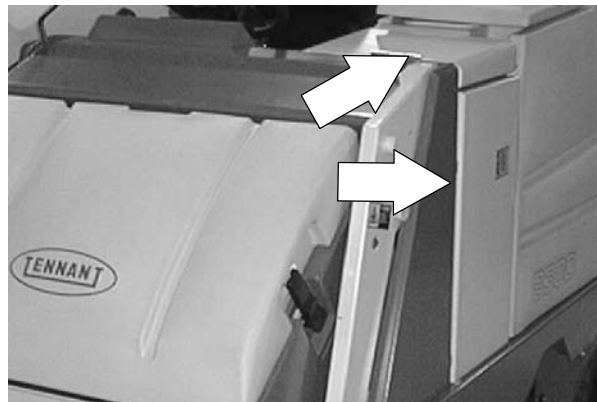

3. Place a block of wood or jack stand under the front of the hopper.

NOTE: Make sure the hopper is positioned tight up against the seal on the filter chamber.



SWEEPING

4. Locate the primary roll-out chain next to the sweeper vacuum fan assembly.

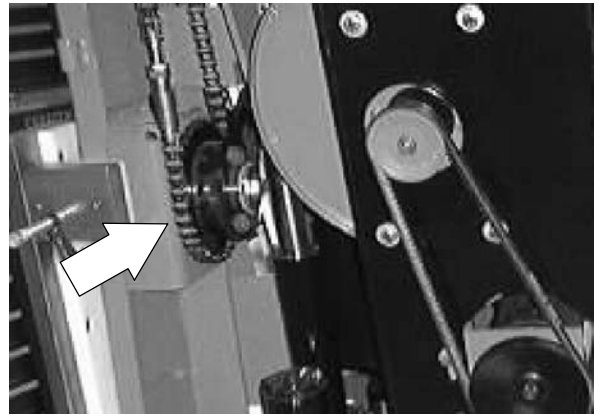

5. Loosen the chain tensioner jam nut. Back off the adjuster body. This will relax the tension on the primary roll-out chain.

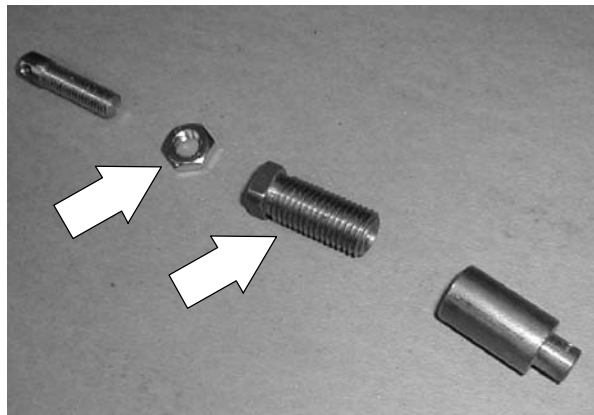

6. Check slots on the actuator sprocket. The hardware should be centered in the slots. Loosen the hardware and rotate the large sprocket so the hardware is centered in the slots. Tighten the hardware to 37 - 48 Nm (26 - 34 ft lb)

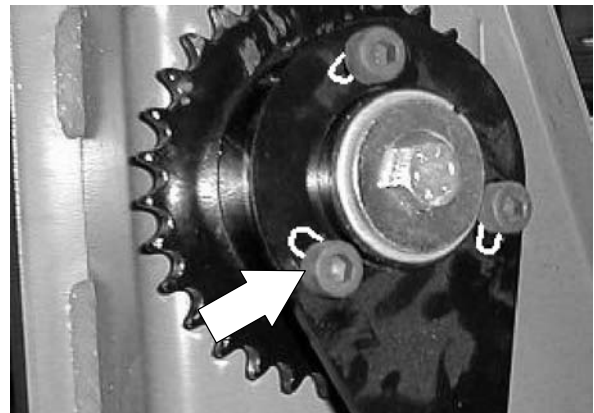

7. Tighten the chain adjuster body tight. Make sure there is no slack in the roll-out chain. Tighten the jam nut. **Make sure the chain tensioner assembly is 2-3 links above the teeth on the large sprocket.**

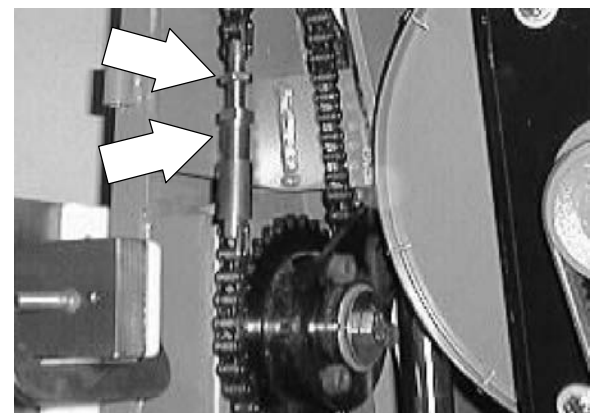

- Remove the block from under the front of the hopper.



- Plug the battery connector into the machine. Close the rear cover.

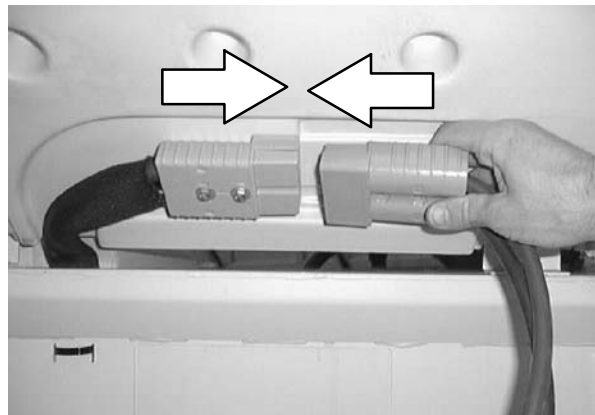

- Operate the hopper raise function. Check the roll-out of the hopper. Lower the hopper. Check to make sure the hopper seal is tight against the filter chamber.

NOTE: Re-adjust primary chain if necessary.

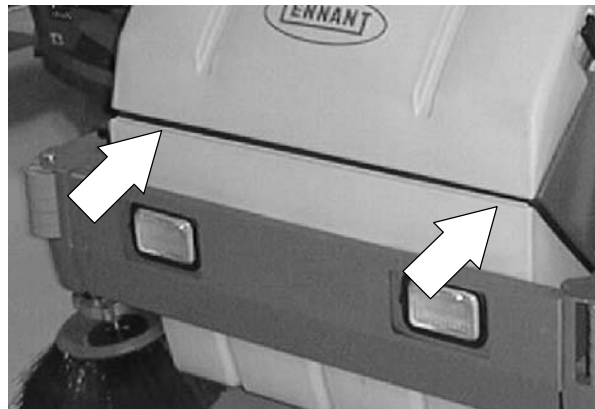

- Close the top cover and side door.

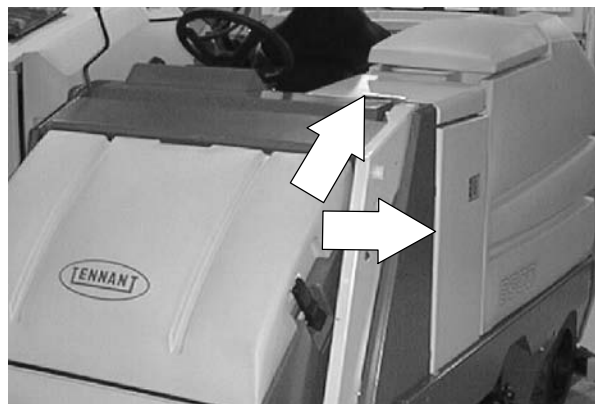

SWEEPING

TO REPLACE HOPPER PRIMARY ROLL OUT CHAIN

FOR SAFETY: Before Leaving Or Servicing Machine; Stop On Level Surface, Set Parking Brake.

1. Raise the rear cover and unplug the battery connector.

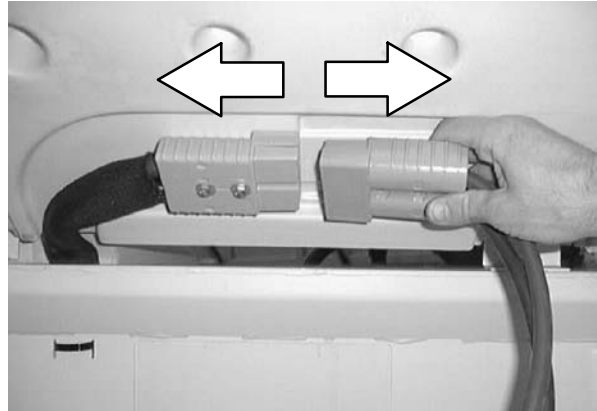

2. Open the top cover and side door.



3. Place a block of wood or jack stand under the front of the hopper.

NOTE: Make sure the hopper is positioned tight up against the seal on the filter chamber.



4. Locate the primary roll-out chain next to the sweeper vacuum fan assembly.

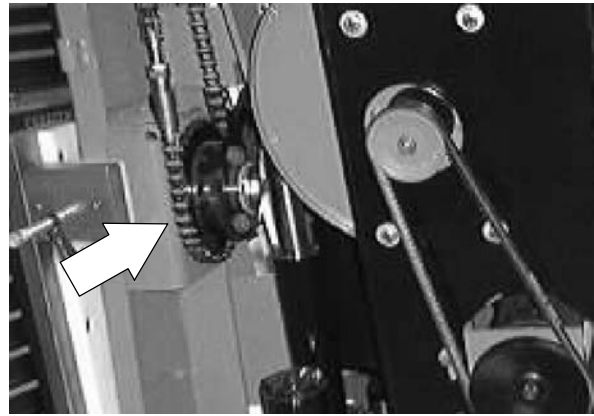

5. Loosen the chain tensioner jam nut. Back off the adjuster body. This will relax the tension on the primary roll-out chain.

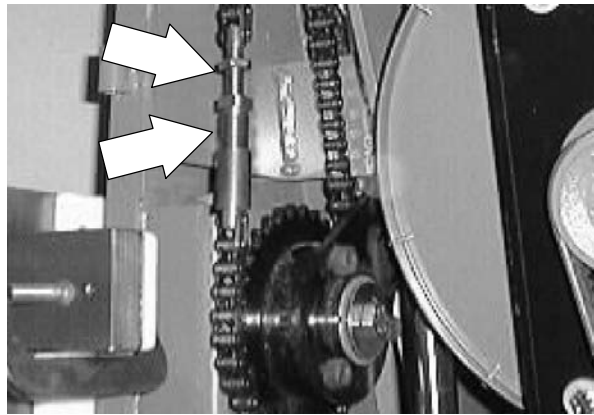

6. Continue to unscrew the adjuster body until the adjuster body is free from the adjuster housing. Remove the primary chain from the machine.

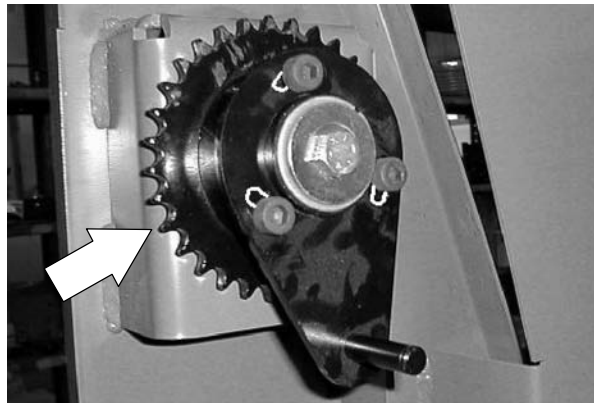

7. Remove the adjuster from the existing chain. Install on the new chain in the same orientation.

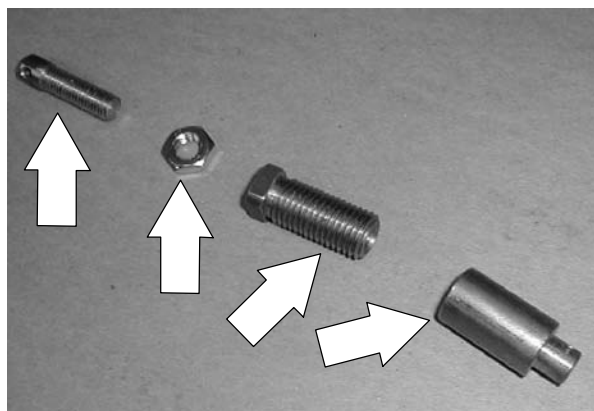

SWEEPING

8. Install the new primary chain and adjuster onto the large actuator sprocket and smaller lift arm sprocket.

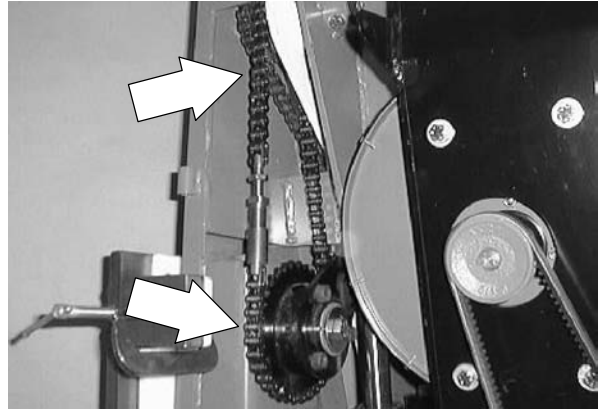

9. Position the new chain so the adjuster is positioned 2-3 chain links above the teeth of the large actuator sprocket.

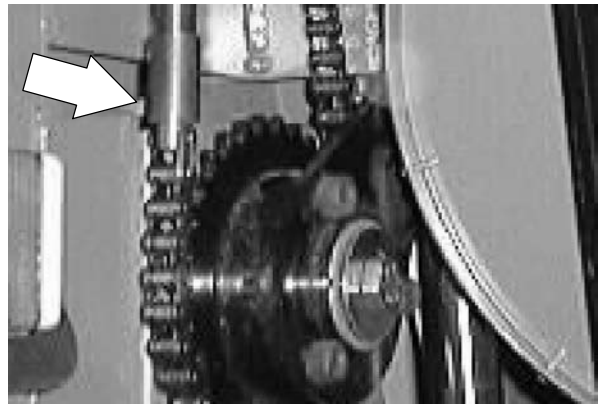

10. Tighten the chain adjuster body tight. Make sure there is no slack in the roll-out chain. Tighten the jam nut. **Make sure the chain tensioner assembly is 2-3 links above the teeth on the large sprocket.**

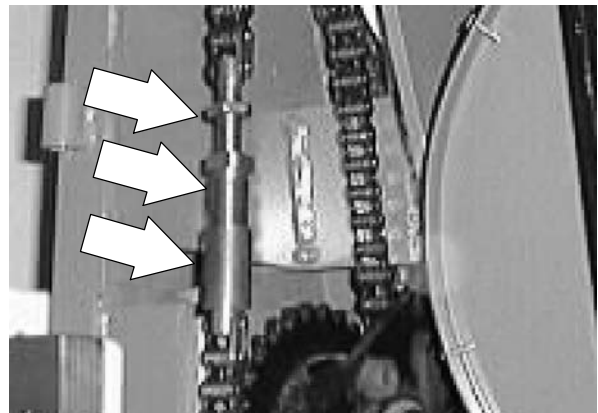

11. Remove the block from under the front of the hopper.



12. Plug the battery connector into the machine.
Close the rear cover.

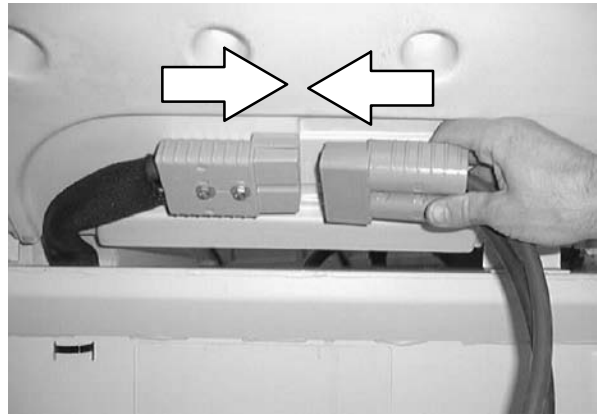

13. Operate the hopper raise function. Check the roll-out of the hopper. Lower the hopper. Check to make sure the hopper seal is tight against the filter chamber. See TO ADJUST PRIMARY HOPPER ROLL-OUT CHAIN instructions.

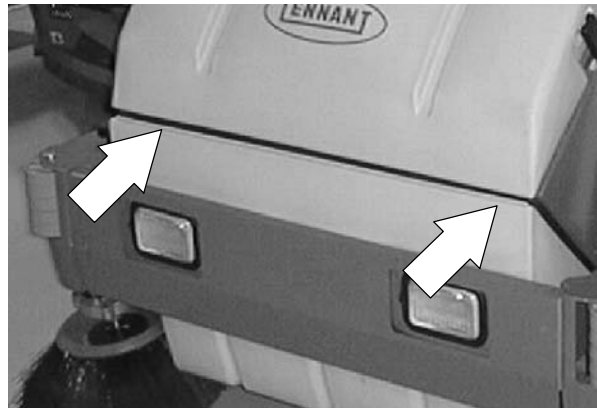

14. Close the top cover and side door.

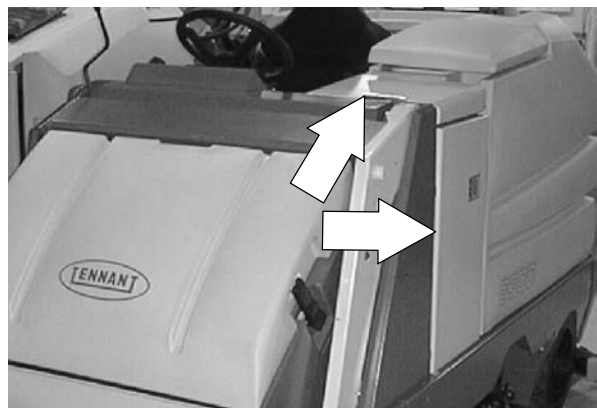

SWEEPING

TO ADJUST HOPPER SECONDARY ROLL OUT CHAIN

FOR SAFETY: Before Leaving Or Servicing Machine; Stop On Level Surface, Set Parking Brake.

1. Turn on the machine and raise the hopper about 1/3 of the way up. Turn off the machine.



2. Raise the rear cover and unplug the battery connector.

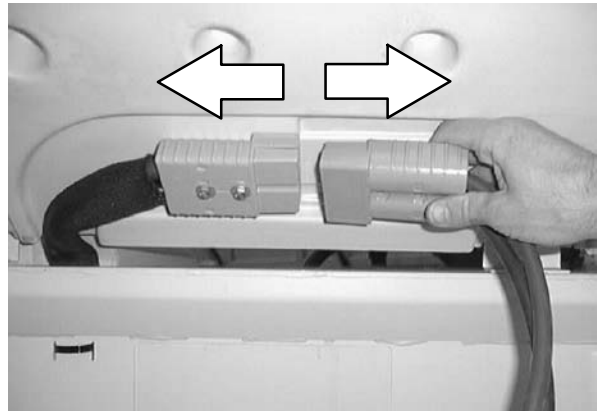

3. Remove the three screws holding the plastic cover to the left side lift arm. Remove the cover.



4. Locate the secondary roll-out chain adjuster.

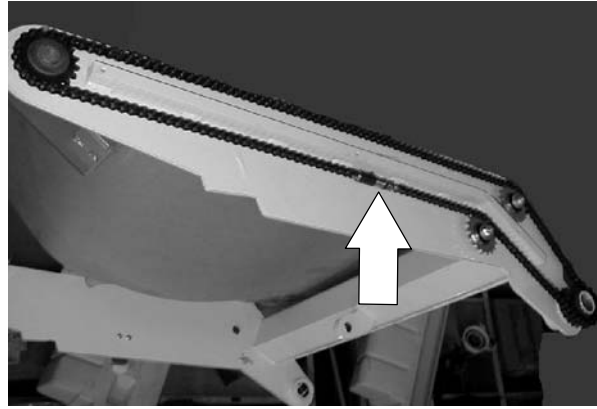

5. Loosen the jam nut on the tension adjuster.

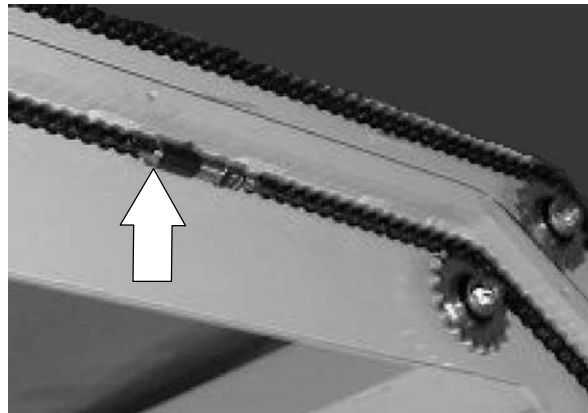

6. Tighten the chain adjuster body tight. Make sure there is no slack in the roll-out chain. Tighten the jam nut.

NOTE: Make sure the chain tensioner assembly is positioned about half way between the upper and lower sprockets.

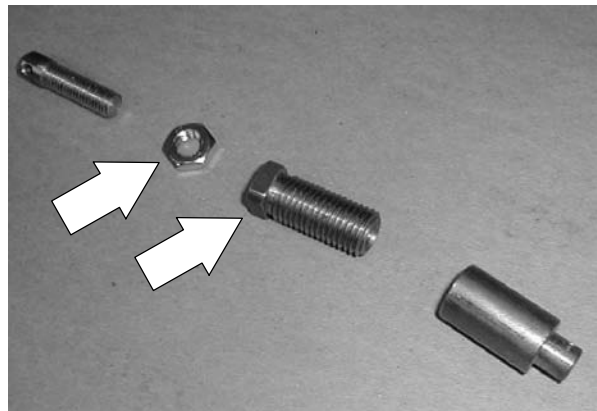

7. Plug the battery connector into the machine. Close the rear cover.

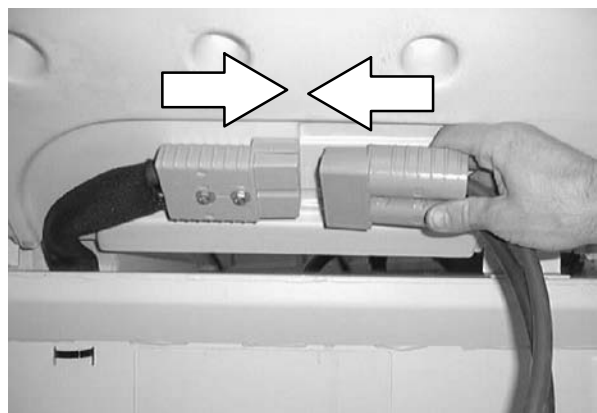

SWEEPING

8. Operate the hopper raise function. Check the roll-out of the hopper. Lower the hopper. Check to make sure the hopper seal is tight against the filter chamber. *Re-adjust secondary chain if necessary. If needed--see TO ADJUST PRIMARY HOPPER ROLL-OUT CHAIN instructions.*

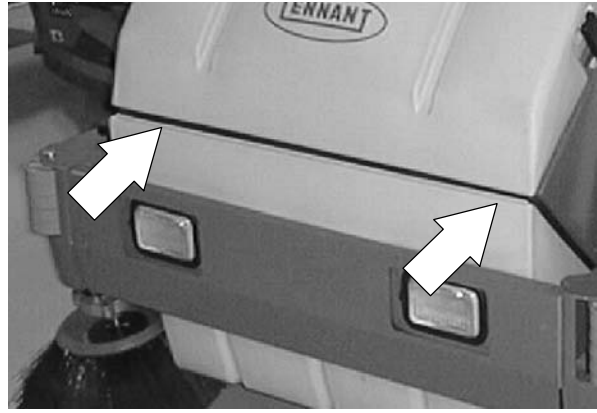

9. Reinstall the left side lift arm cover.



TO REPLACE HOPPER SECONDARY ROLL OUT CHAIN

FOR SAFETY: Before Leaving Or Servicing Machine; Stop On Level Surface, Set Parking Brake.

1. Turn on the machine and raise the hopper about 1/3 of the way up. Turn off the machine.



2. Remove the three screws holding the plastic cover to the left side lift arm. Remove the cover.



3. Turn on the machine and lower the hopper.



SWEEPING

4. Raise the rear cover and unplug the battery connector.

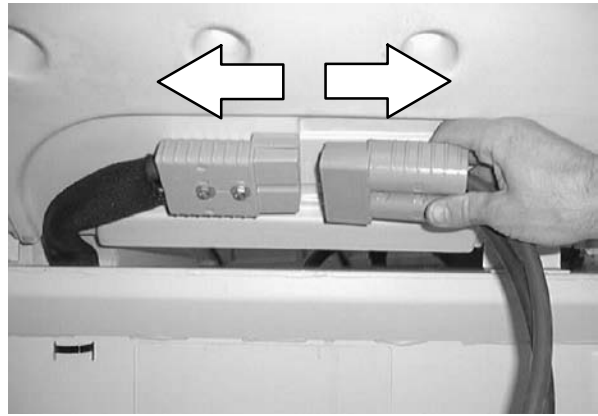

5. Locate the secondary roll-out chain adjuster.

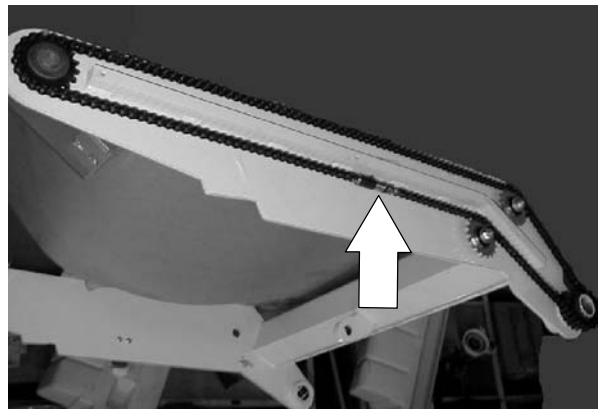

6. Loosen the jam nut on the tension adjuster.

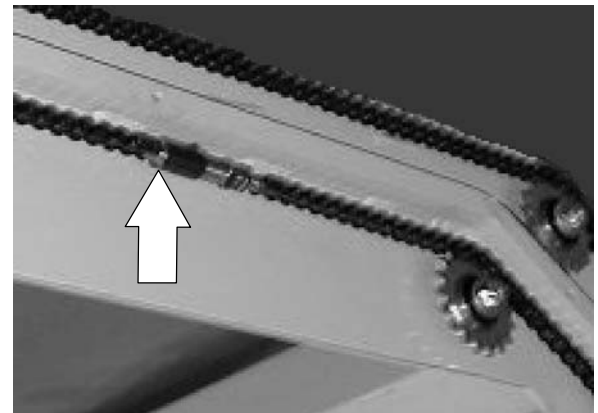

7. Continue to unscrew the adjuster body until the adjuster body is free from the adjuster housing. Remove the secondary chain from the machine.

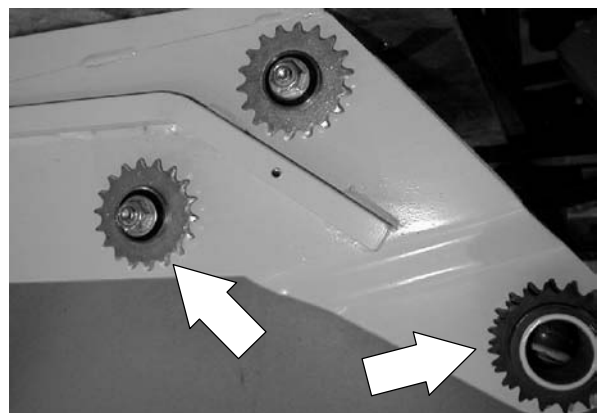

8. Remove the adjuster from the existing chain. Install on the new chain in the same orientation.

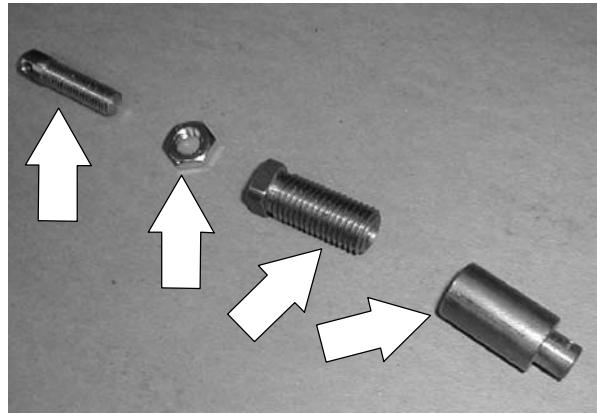

9. Check the two idler sprockets for any bearing looseness and the condition of the teeth.

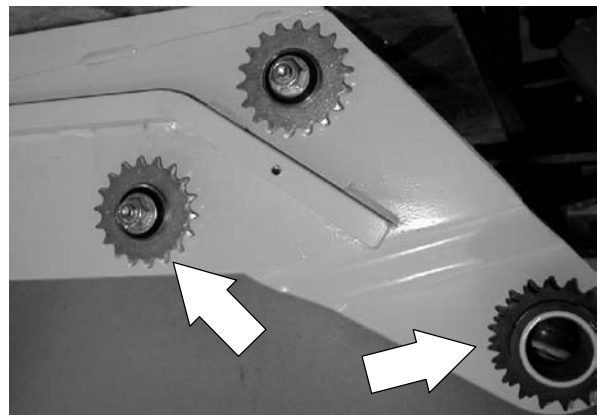

10. Install the new secondary chain and adjuster onto the bottom hopper sprocket, two idler sprockets, and smaller lift arm sprocket.

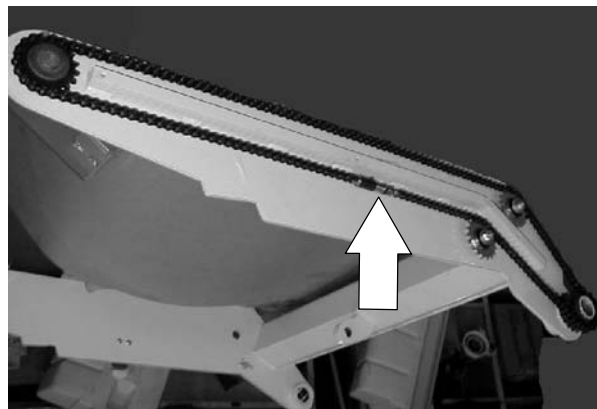

11. Tighten the chain adjuster body tight. Make sure there is no slack in the roll-out chain. Tighten the jam nut. **Make sure the chain tensioner assembly is positioned about half way between the upper and lower sprockets.**

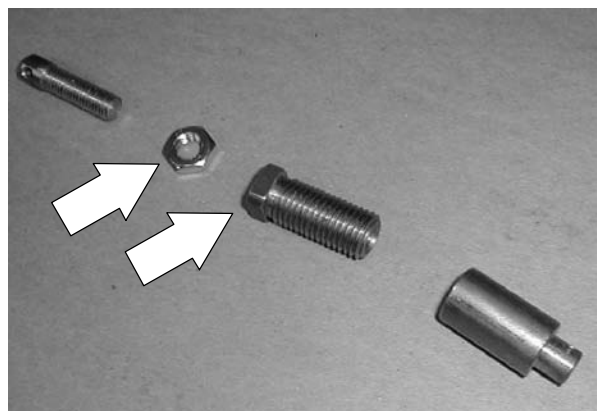

SWEEPING

12. Plug the battery connector into the machine.
Close the rear cover.

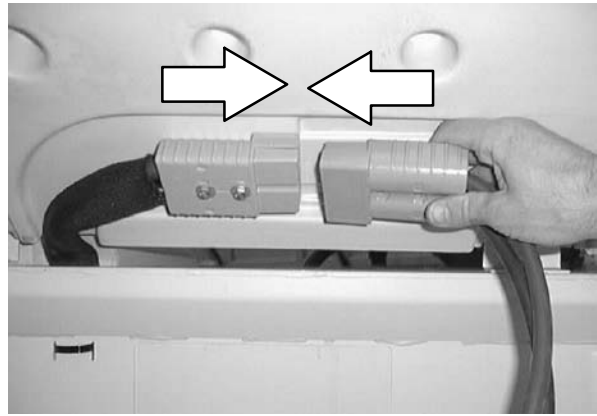

13. Operate the hopper raise function. Check the roll-out of the hopper. Lower the hopper. Check to make sure the hopper seal is tight against the filter chamber. *Re-adjust secondary chain if necessary. If needed--see TO ADJUST PRIMARY HOPPER ROLL-OUT CHAIN instructions.*

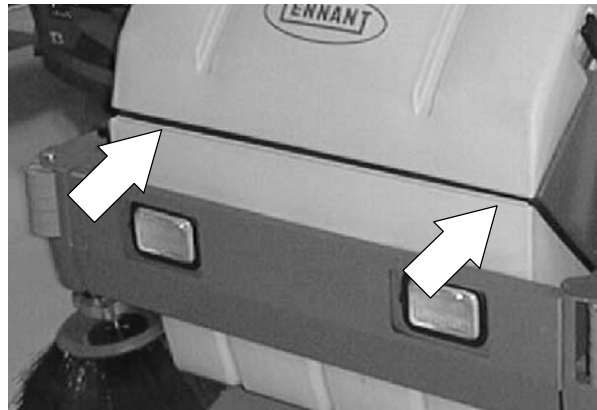

14. Reinstall the left side lift arm cover.



HOPPER DUST FILTER

The dust filter filters the air pulled up from the hopper. The dust filter is equipped with a shaker to remove the accumulated dust particles. The dust filter shaker is operated by the filter shaker switch.

Shake the dust filters before dumping the hopper and at the end of every work shift. Check and clean the dust filters every 50 hours of operation. Extremely dusty conditions may require more frequent cleaning of dust filters.

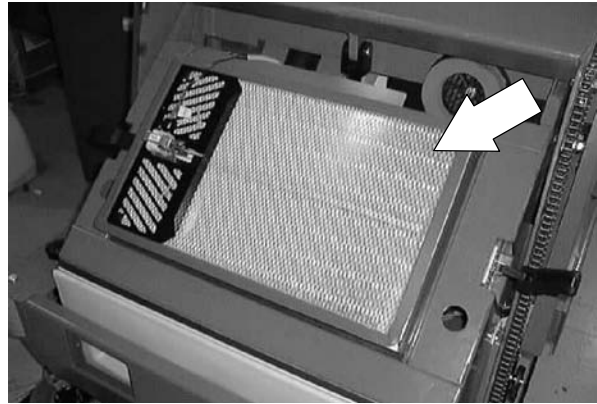

TO REPLACE HOPPER DUST FILTER

FOR SAFETY: Before Leaving Or Servicing Machine; Stop On Level Surface, Set Parking Brake.

1. Un-snap the two hopper filter cover lock straps.



2. Remove the filter cover.



SWEEPING

3. Disconnect the two wires from the filter shaker solenoid.

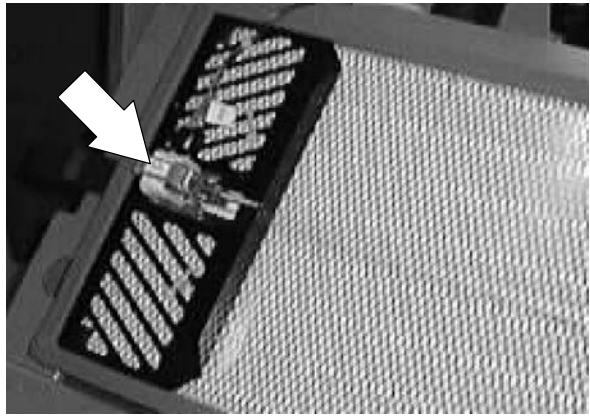

4. Remove the shaker assembly from the filter.

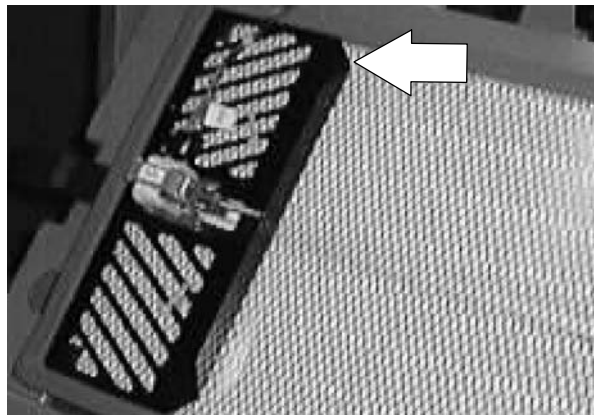

5. Remove the filter from the sweeper assembly.



6. Install the new debris filter into the filter housing.

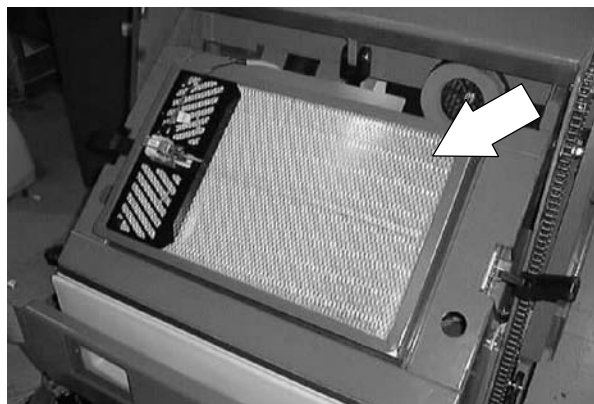

7. Install the shaker assembly onto the new filter.

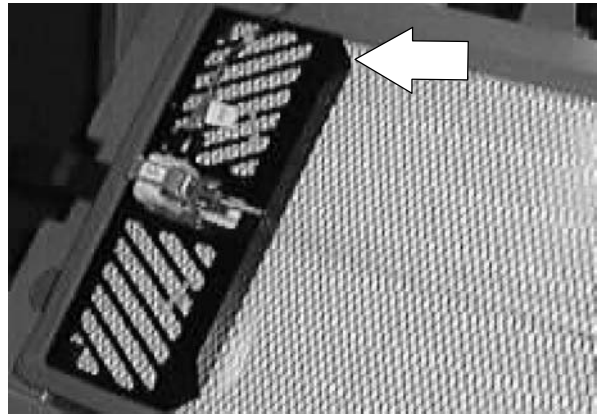

8. Route the shaker wires into the slits in the filter seal.

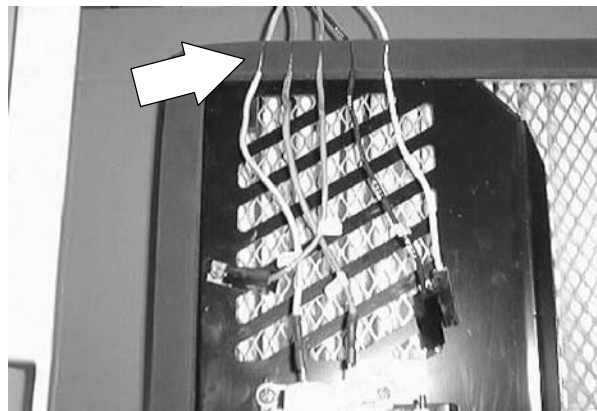

9. Reinstall the filter cover. Secure the filter cover with the two lock straps.



10. Operate the machine. Check the filter shaker for proper operation.

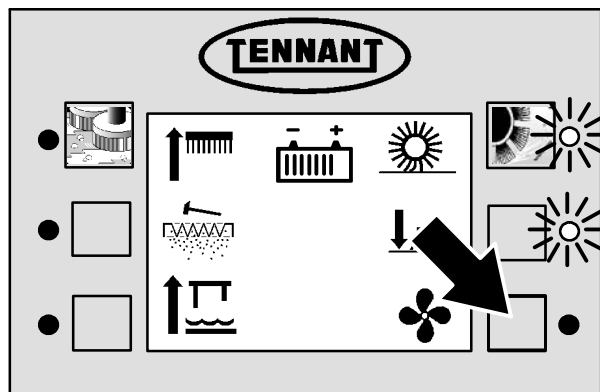

SWEEPING

MAIN BRUSH

The main brush sweeps debris from the floor into the upper sweep brush. The cylindrical elevator throws the debris into the hopper. The side brush sweeps debris into the path of the lower main brush.

TO REPLACE MAIN SWEEP BRUSH

FOR SAFETY: Before Leaving Or Servicing Machine; Stop On Level Surface, Set Parking Brake.

1. Open the right hand sweeper brush door.



2. Remove the knob bolt holding the lower brush arm to the brush tube.

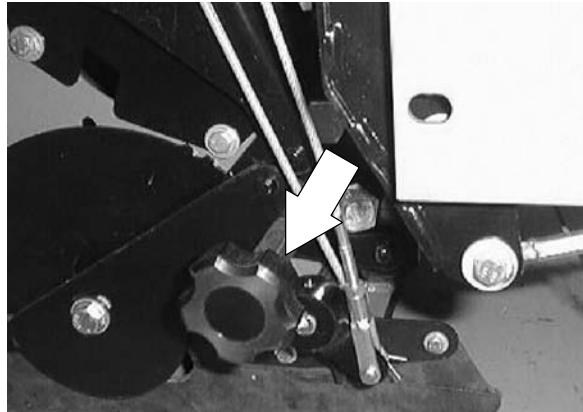

3. Remove the three smaller plastic knobs holding the skirt plate assembly to the frame.

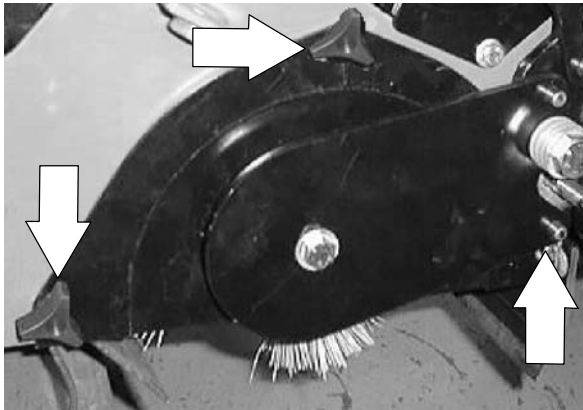

4. Pull the lower brush arm and skirt assembly off the brush tube and out of the machine.

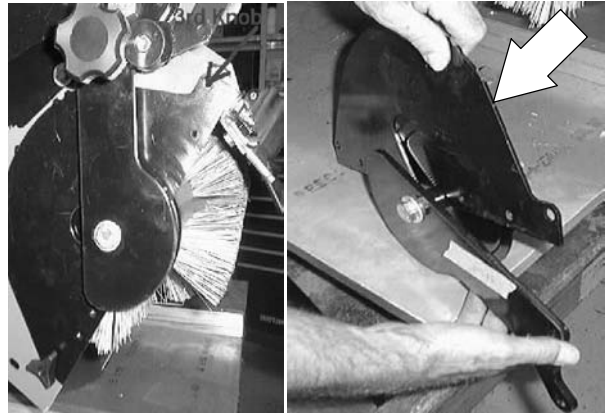

5. Pull the lower main brush out of the machine.

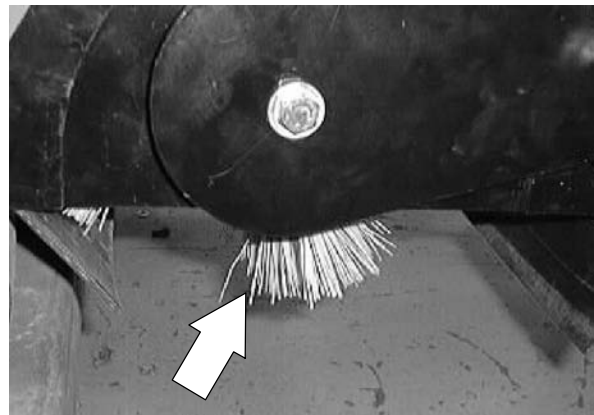

6. Flip the existing brush end to end or install a new lower main sweep brush.

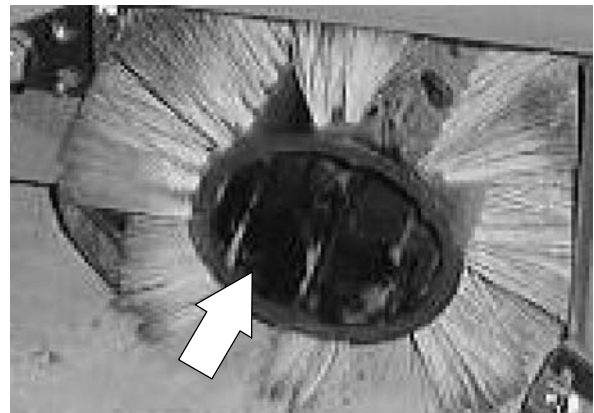

7. Rotate the brush until it slips on and engages the drive plug on the left side of the sweeper assembly.

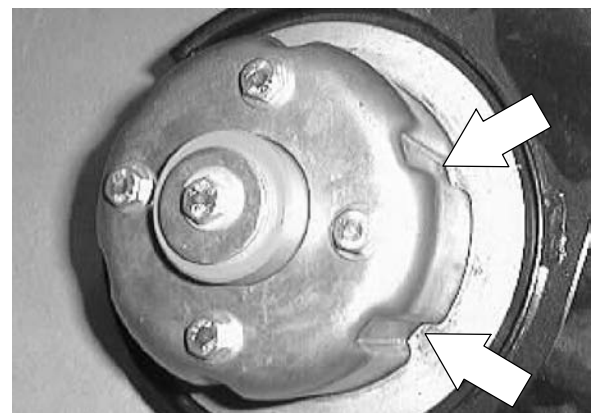

SWEEPING

8. Reinstall the brush idler arm and idler plug into the end of the main sweep brush.

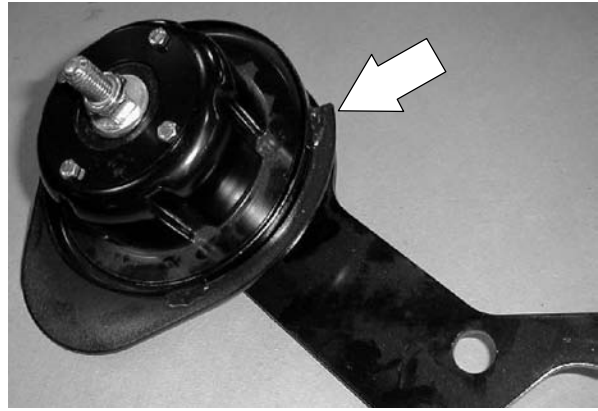

9. Reinstall the skirt plate assembly onto the frame. Reinstall the three plastic knobs and tighten.

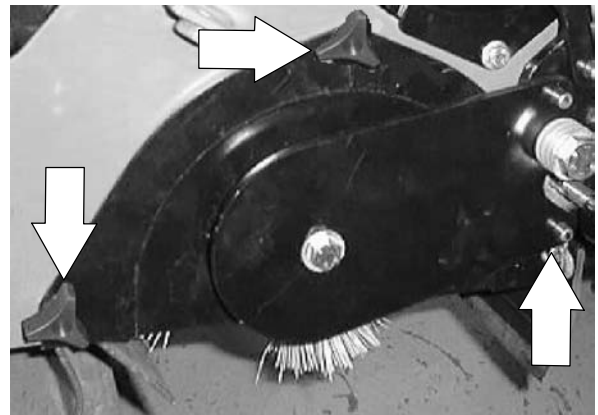

10. Position the main brush idler arm onto the brush tube. Reinstall the knob bolt and tighten tight.

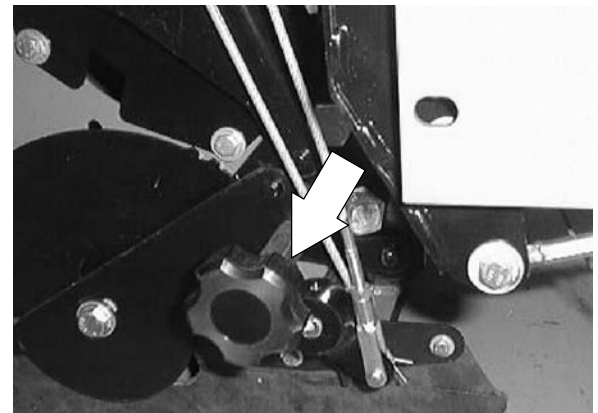

11. Close the right hand brush door.

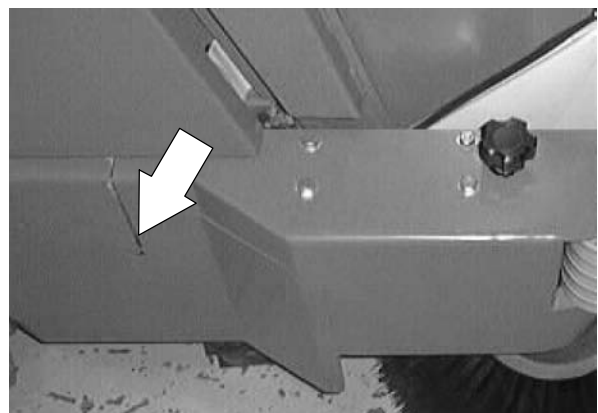

12. Operate the machine. Check the new brush for proper pattern. See TO CHECK AND ADJUST MAIN BRUSH PATTERN instructions in this section.

TO REPLACE CYLINDRICAL ELEVATOR

FOR SAFETY: Before Leaving Or Servicing Machine; Stop On Level Surface, Set Parking Brake.

1. Open the right hand brush door.

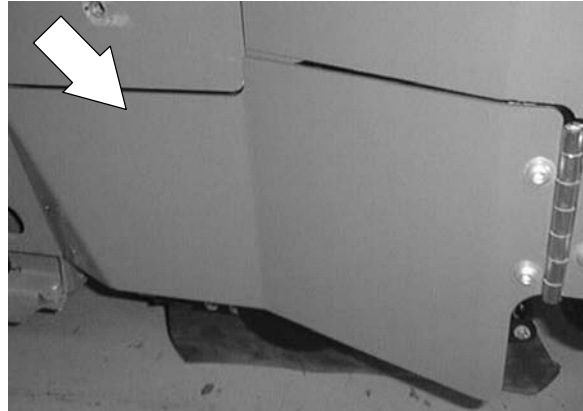

2. Remove the hex screw holding the cylindrical elevator arm to the brush tube.

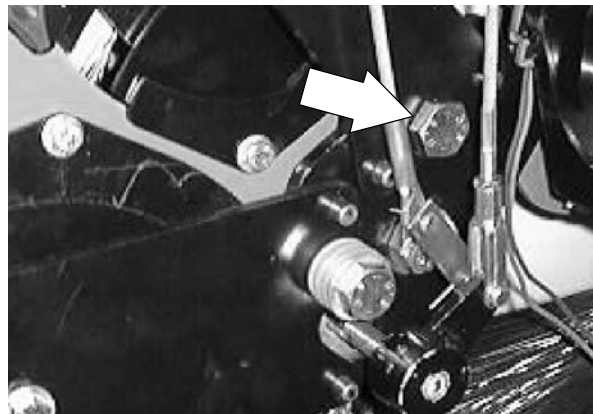

3. Remove the three nuts holding the upper skirt plate assembly to the frame.

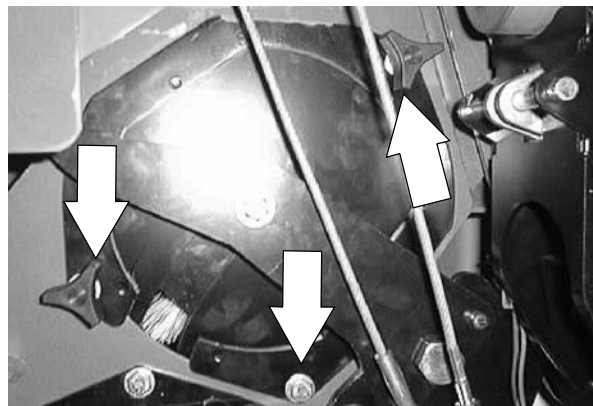

SWEEPING

4. Pull the cylindrical elevator arm and skirt assembly off the brush tube and out of the machine.

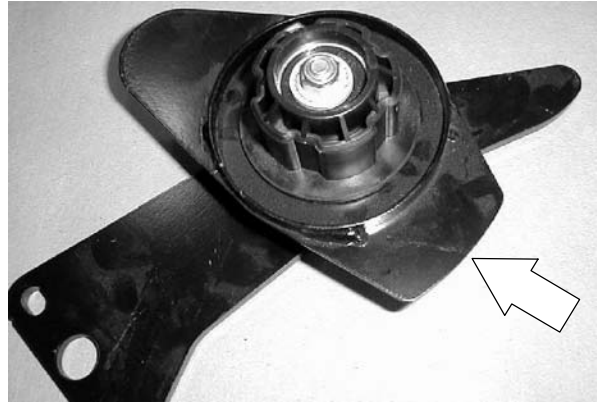

5. Pull the cylindrical elevator out of the machine.



6. Flip the cylindrical elevator end to end or install a new cylindrical elevator.



7. Rotate the cylindrical elevator until it slips on and engages the drive plug on the left side of the sweeper assembly.

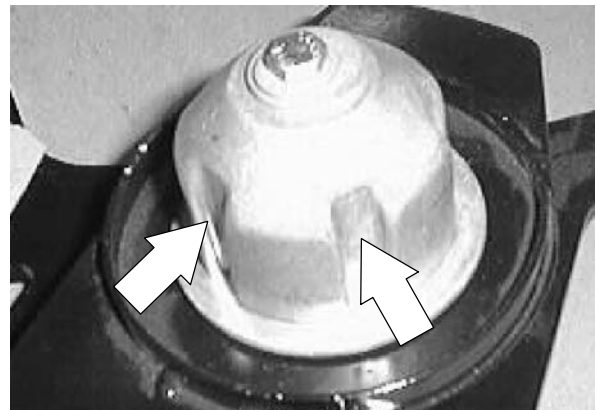

8. Reinstall the cylindrical elevator idler arm and idler plug into the end of the cylindrical elevator.

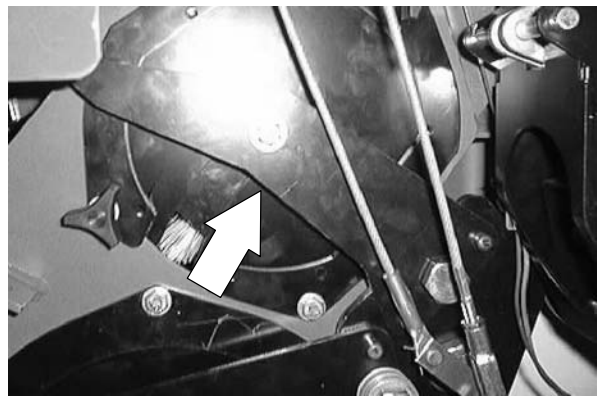

9. Reinstall the skirt plate assembly onto the frame. Reinstall the three nuts and tighten.

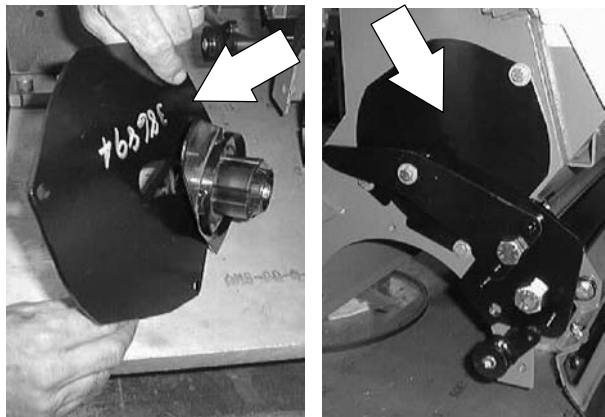

10. Position the cylindrical elevator idler arm onto the brush tube. Reinstall the hex screw and tighten tight.

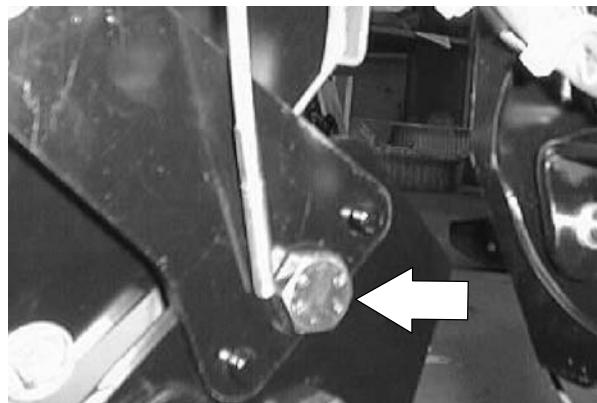

11. Close the right hand brush door.

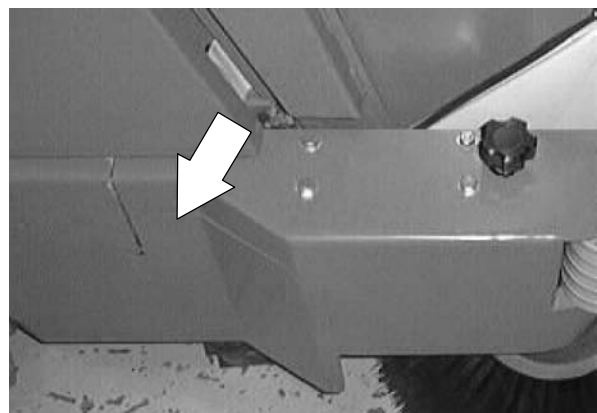

12. Operate the machine. Check the new cylindrical elevator for proper operation.

SWEEPING

TO CHECK AND ADJUST MAIN BRUSH PATTERN

TO CHECK MAIN BRUSH PATTERN

1. Apply chalk, or some other material that will not blow away easily, to a smooth, level floor.
2. Turn on the machine. With the main brush raised, park the assembly over the chalked area.

NOTE: If no chalk or other material is available, allow the brush to spin on the floor for two minutes.

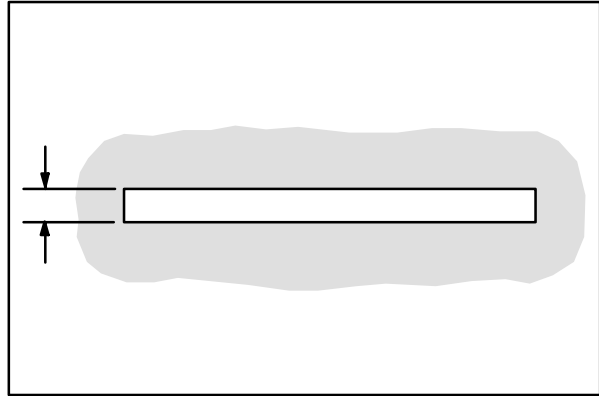

3. With a foot on the brake to keep the machine from moving, lower the main brush to the floor for 15 to 20 seconds. Raise the assembly and back the machine away from the test area.
4. Look at the pattern the main brush made. The pattern should measure evenly 2 to 3 in (50 to 75 mm) across the length of the brush.
5. If the brush pattern is tapered more than 0.50 in (13 mm) from one end of the pattern to the other, the main brush needs to be leveled.

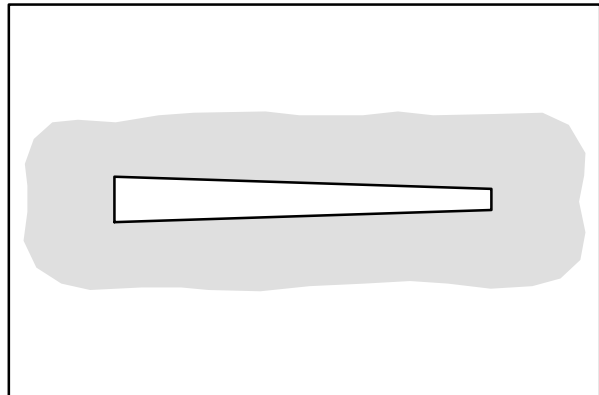

TO ADJUST MAIN BRUSH PATTERN

1. Open the right hand brush door. Locate the brush pattern adjustment bolt at the end of the cylindrical elevator arm. Adjust the bolt DOWN to *increase* the brush pattern. Adjust the bolt UP to *decrease* the brush pattern.

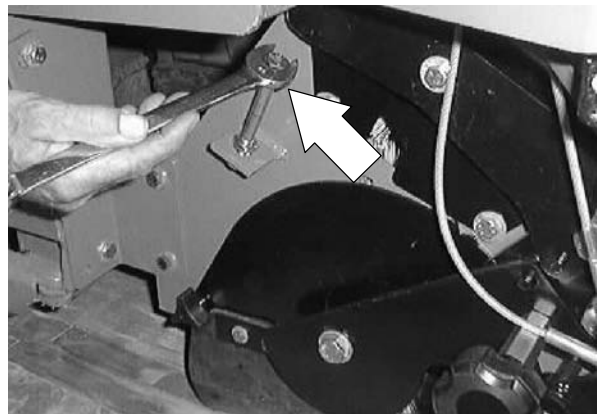

TO ADJUST MAIN BRUSH LEVELNESS

1. Locate the main brush tube adjustment bracket at the front, right corner of the sweeper frame. *Access this area by going in between the right hand side brush and the side of the debris hopper.*

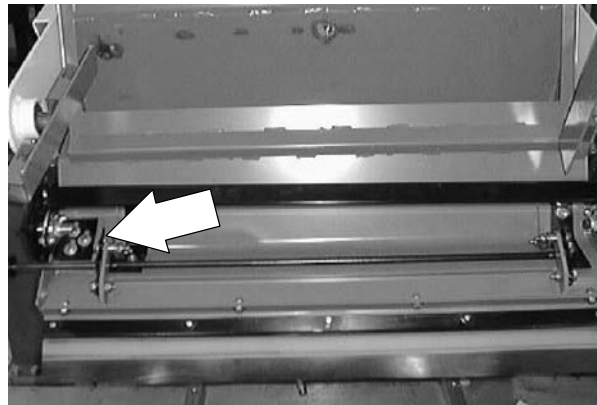

2. Locate the three hex screws holding the brush tube mount bracket to the sweeper frame.



3. Loosen the three hex screws. Move the bracket up or down to achieve an even taper on the brush pattern. Tighten the hex screws to 18 - 24 Nm (15 - 20 ft lb).

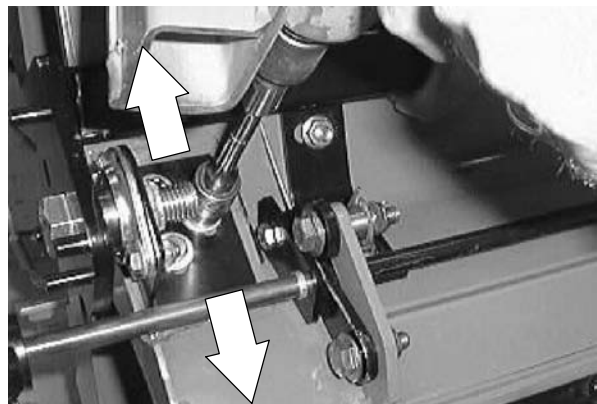

4. Re-check the main brush pattern.

SWEEPING

MAIN BRUSH DRIVE BELTS

The main brush primary drive belt transfers power from the electric motor to the large two groove sheave. The main brush secondary drive belt transfers power from the two groove sheave to the main brush sheave and the cylindrical elevator sheave. The belts should be checked after every 400 hours of operation for wear.

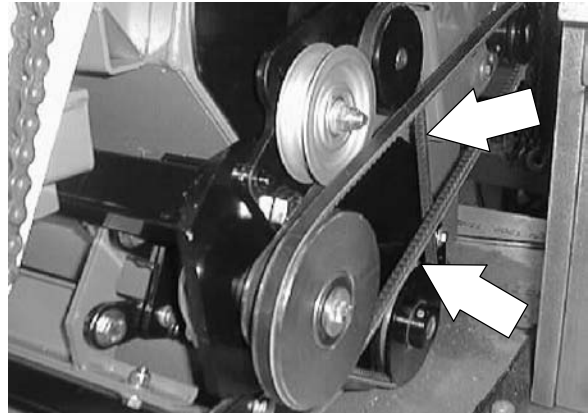

TO REPLACE MAIN BRUSH PRIMARY DRIVE BELT

1. Turn off the machine and set the machine parking brake.

FOR SAFETY: Before Leaving Or Servicing Machine; Stop On Level Surface, Set Parking Brake, Turn Off Machine And Remove Key.

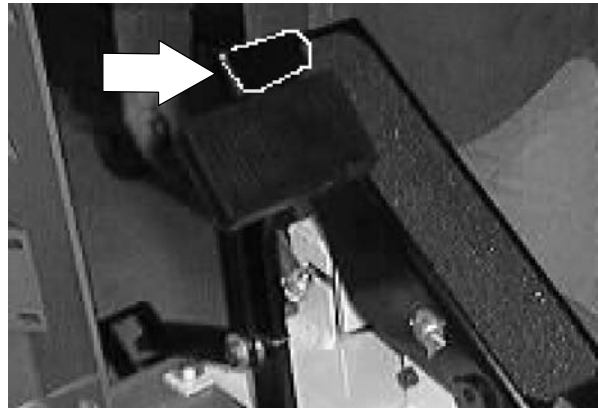

2. Remove the left side brush door.

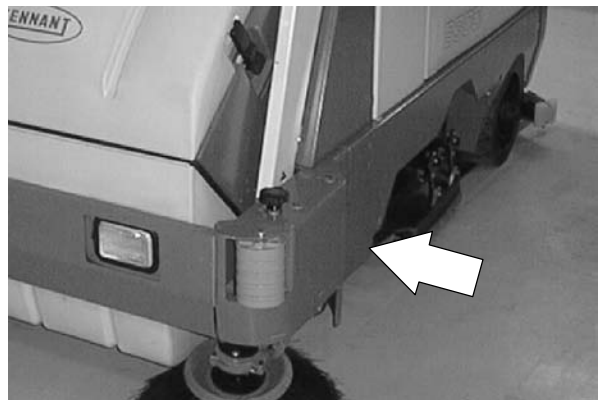

3. Loosen the four hex screws holding the main brush motor to the sweeper frame.

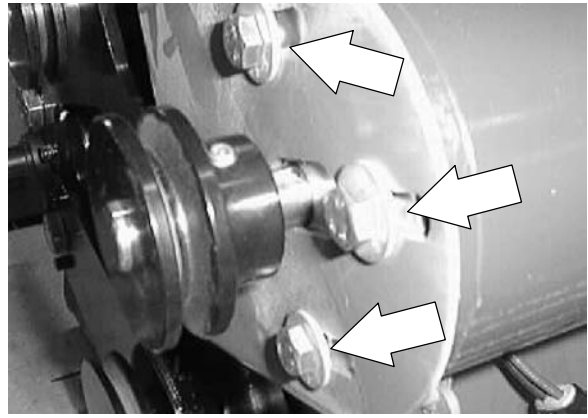

4. Push the main brush motor forward.

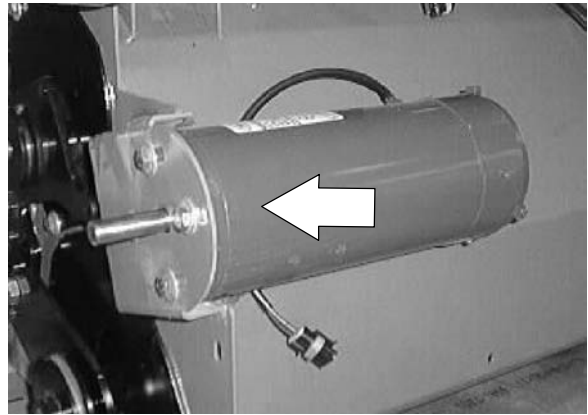

5. Remove the existing primary V-belt from the motor sheave.

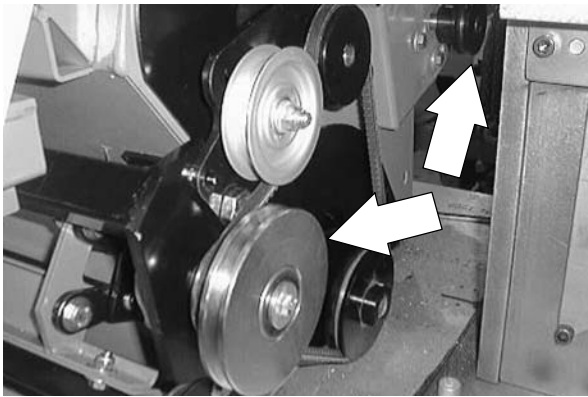

6. Position the new V-belt onto the motor sheave and larger two groove sheave.

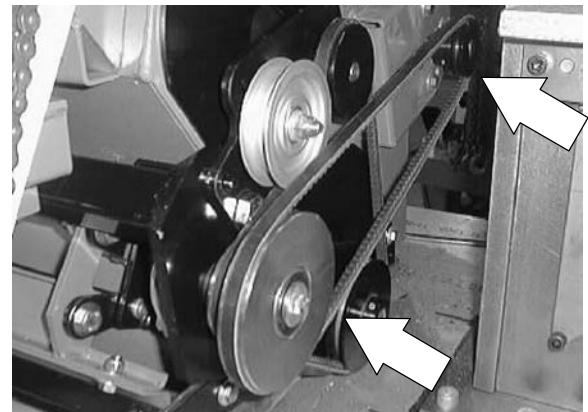

SWEEPING

7. Pull back on the new motor until the V-belt is tight. *The deflection should be 3 to 7mm (0.125 to 0.25 in) when a force of 2.3 kg (5 lb) is applied at the belt midpoint.* The belt should be checked after every 50 hours of operation for wear.

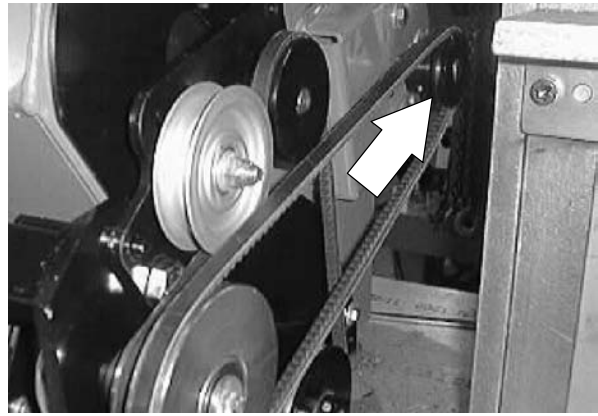

8. Tighten the four motor mount screws to 18 - 24 Nm (15 - 20 ft lb).

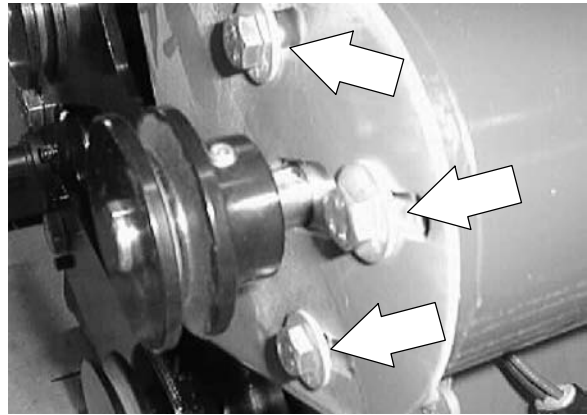

9. Reinstall or close the left side brush door.

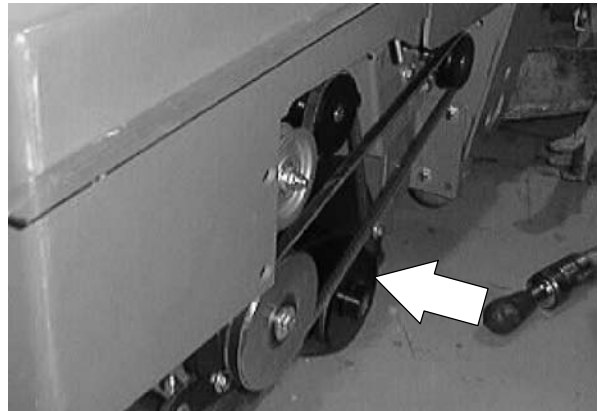

10. Reconnect the battery.

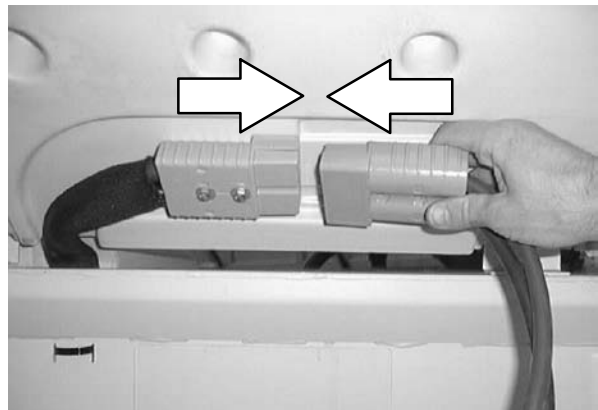

11. Operate the machine. Check the new main brush primary drive belt for proper operation.

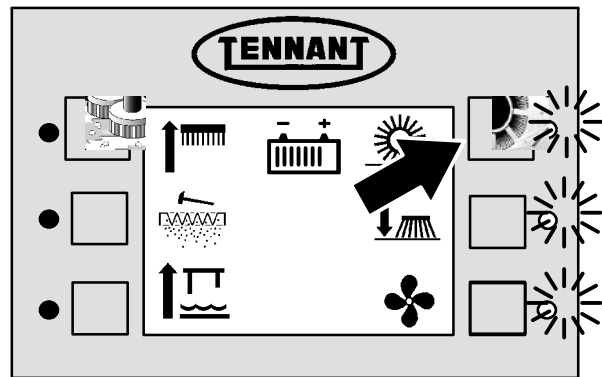

SWEEPING

TO REPLACE MAIN BRUSH SECONDARY DRIVE BELT

1. Turn off the machine and set the machine parking brake.

FOR SAFETY: Before Leaving Or Servicing Machine; Stop On Level Surface, Set Parking Brake, Turn Off Machine And Remove Key.

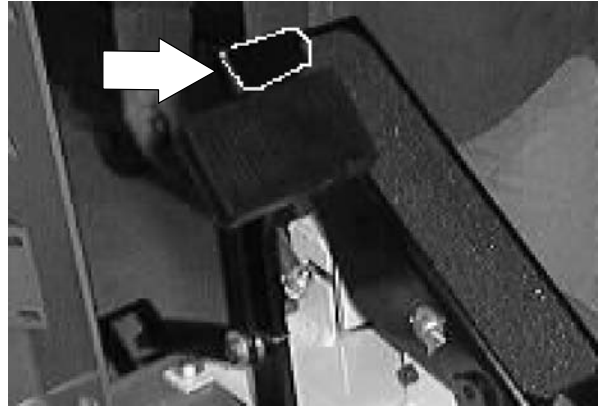

2. Remove the left side brush door.

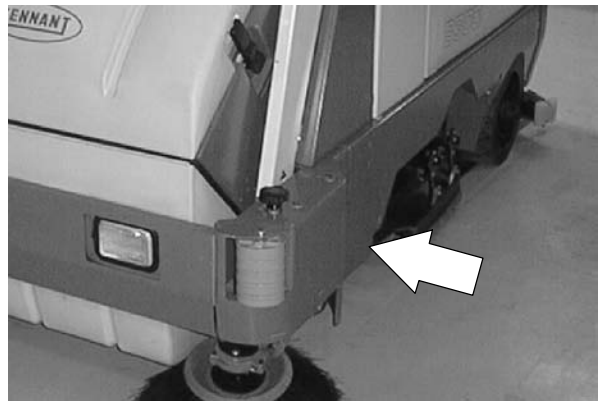

3. Loosen the four hex screws holding the main brush motor to the sweeper frame.

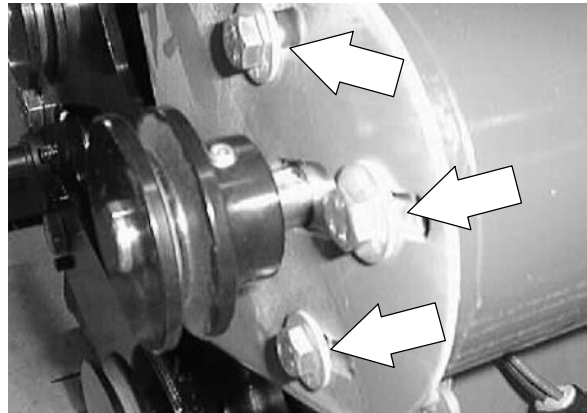

4. Push the main brush motor forward.

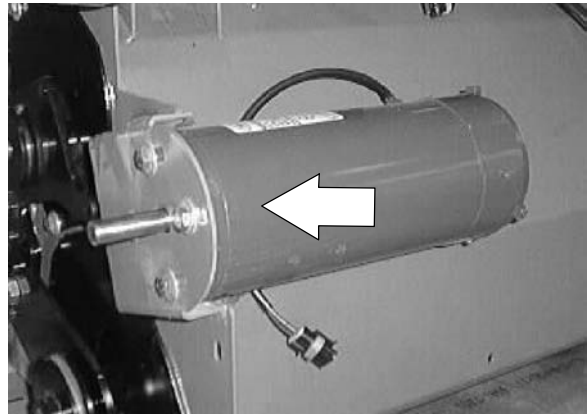

5. Remove the primary V-belt from the motor sheave.

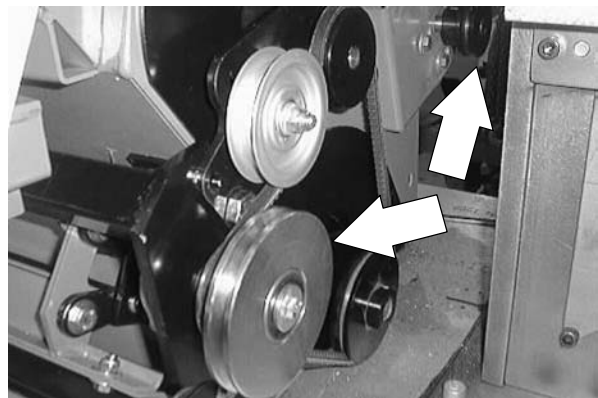

6. Loosen the nut holding the flat idler sheave to the arm. Push the sheave up.

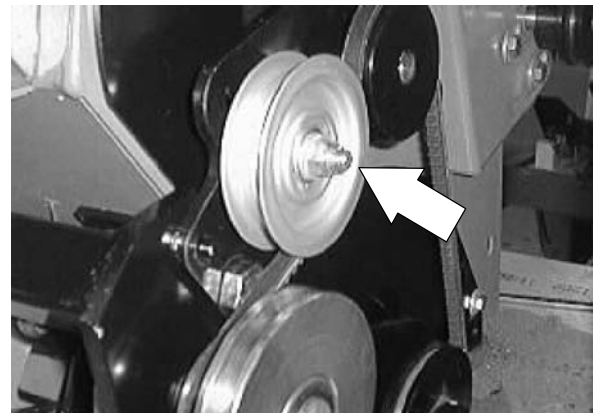

7. Remove the secondary V-belt from the three sheaves.

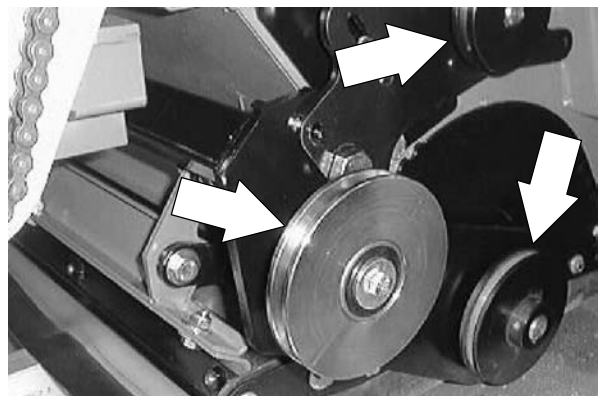

SWEEPING

8. Install the new secondary V-belt onto the three brush sheaves.

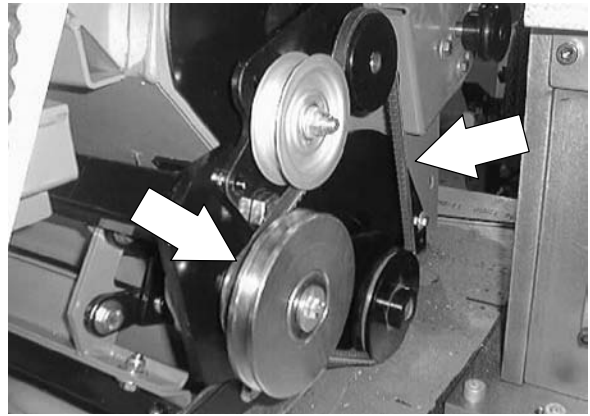

9. Pull down on the flat idler pulley to tighten the V-belt. Tighten the nut to 18 - 24 Nm (15 - 20 ft lb). *The deflection should be 3 to 7mm (0.125 to 0.25 in) when a force of 2.3 kg (5 lb) is applied at the belt midpoint.* The belt should be checked after every 50 hours of operation for wear.

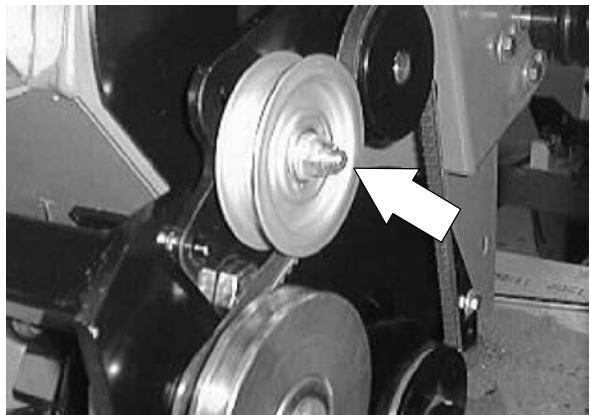

10. Position the primary V-belt onto the motor sheave and larger two groove sheave.

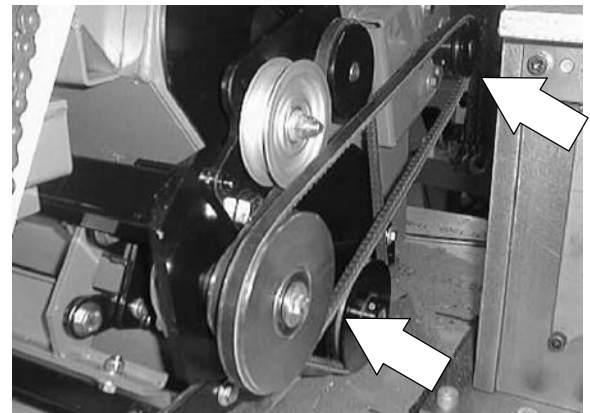

11. Pull back on the new motor until the V-belt is tight. *The deflection should be 3 to 7mm (0.125 to 0.25 in) when a force of 2.3 kg (5 lb) is applied at the belt midpoint.* The belt should be checked after every 50 hours of operation for wear.

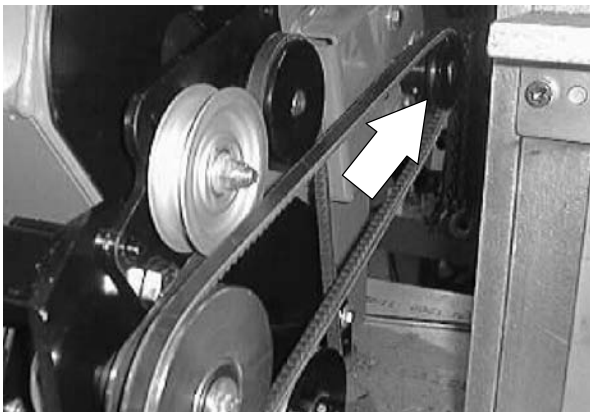

- Tighten the four motor mount screws to 18 - 24 Nm (15 - 20 ft lb).

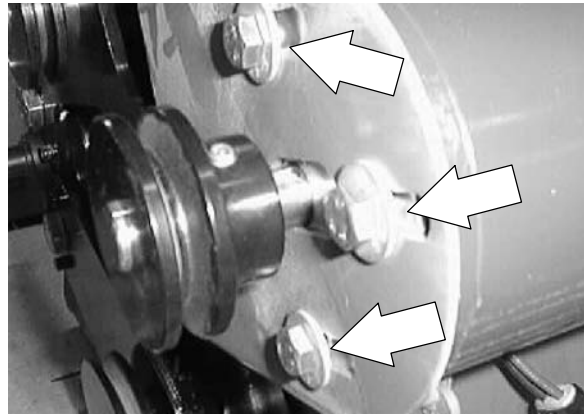

- Reinstall the left side brush door.

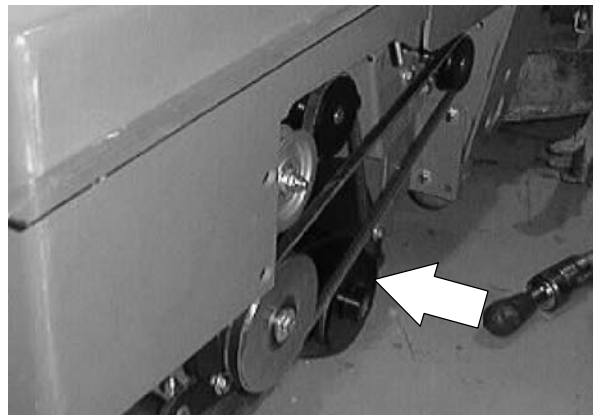

- Reconnect the battery.

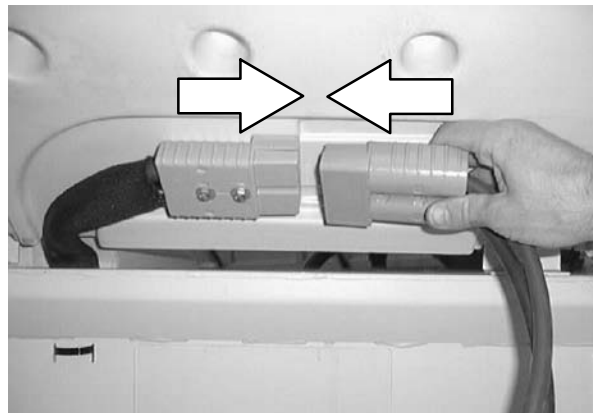

- Operate the machine. Check the new main brush secondary drive belt for proper operation.

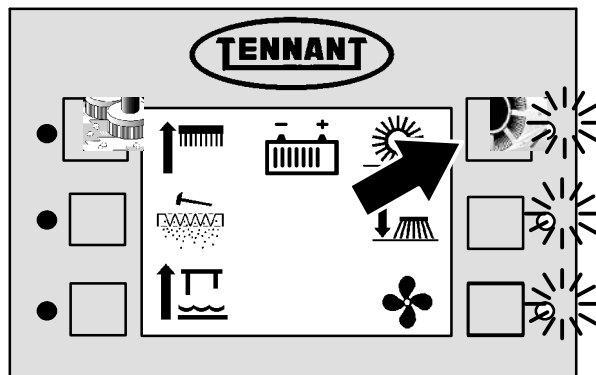

SWEEPING

TO REPLACE MAIN BRUSH IDLER PLUG BEARING

FOR SAFETY: Before Leaving Or Servicing Machine; Stop On Level Surface, Set Parking Brake.

1. Open the right hand sweeper brush door.

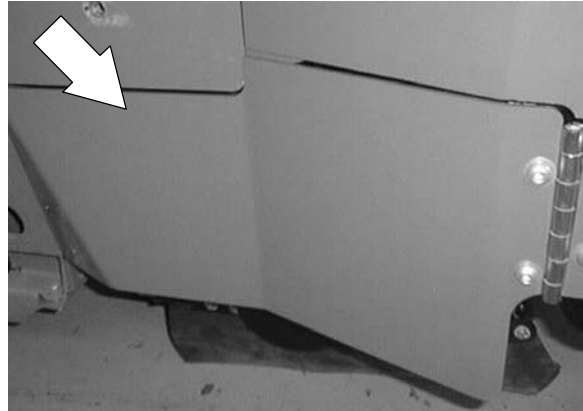

2. Remove the knob bolt holding the lower brush arm to the brush tube.

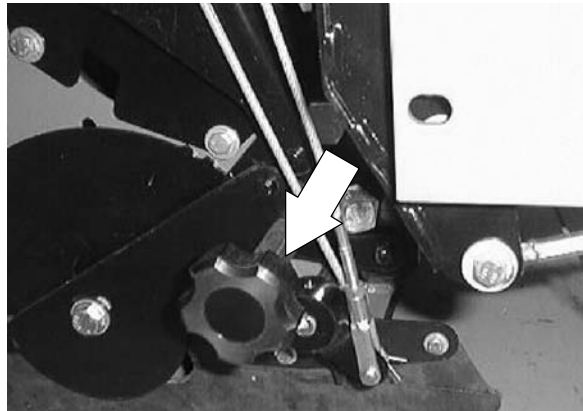

3. Remove the three smaller plastic knobs holding the skirt plate assembly to the frame.

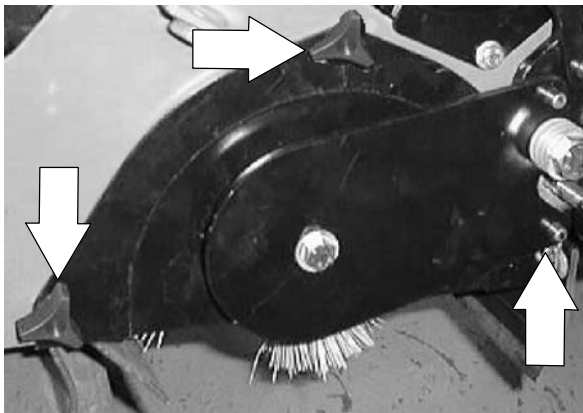

4. Pull the lower brush arm and skirt assembly off the brush tube and out of the machine.

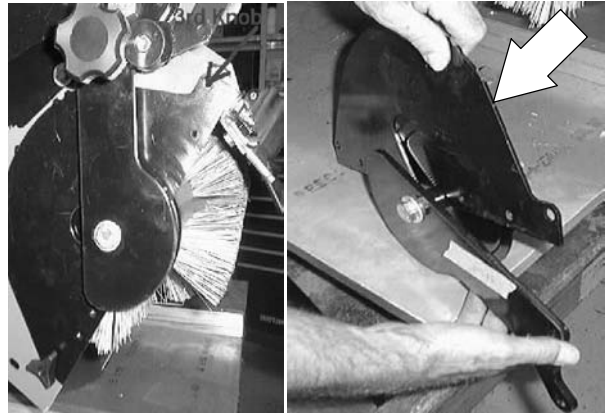

5. Remove the skirt assembly from the idler arm.

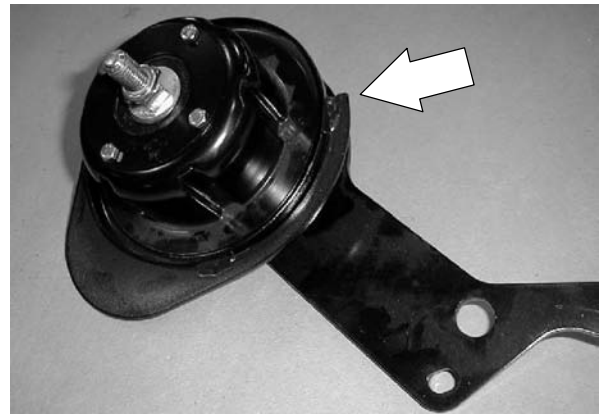

6. Remove the nut and washer holding the main brush idler plug to the brush arm.

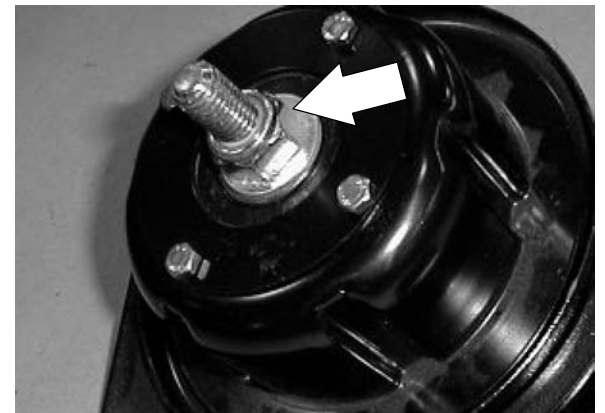

7. Remove the idler pug from the brush arm.

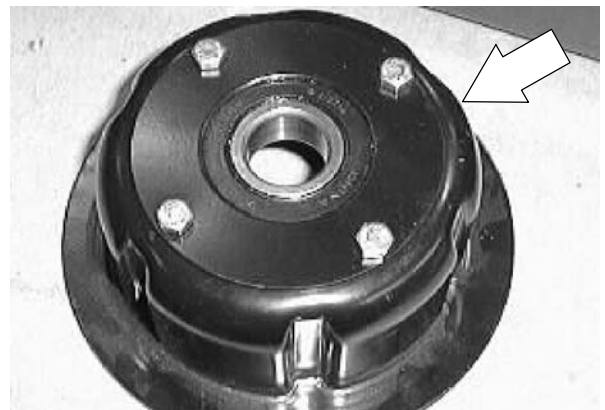

SWEEPING

8. Remove the four hex screws holding the bearing retainer plate to the idler plug.

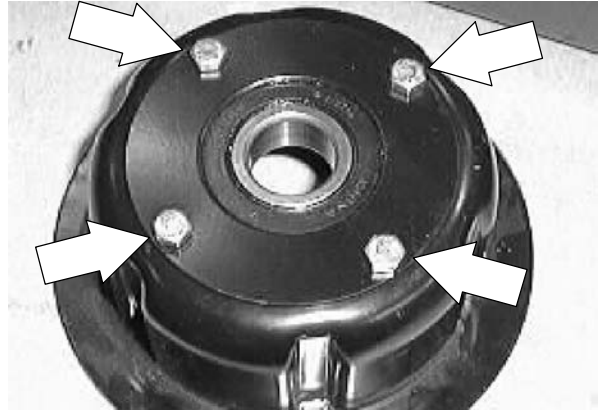

9. Remove the bearing from the idler plug.



10. Use an arbor press to install the new bearing into the idler plug.



11. Reinstall the bearing retainer plate. Tighten the hex screws to 11 - 14 Nm (7 - 10 ft lb).



12. Install the idler plug onto the brush arm.
Tighten the hex screw to 28 - 36 Nm
(20 - 26 ft lb).

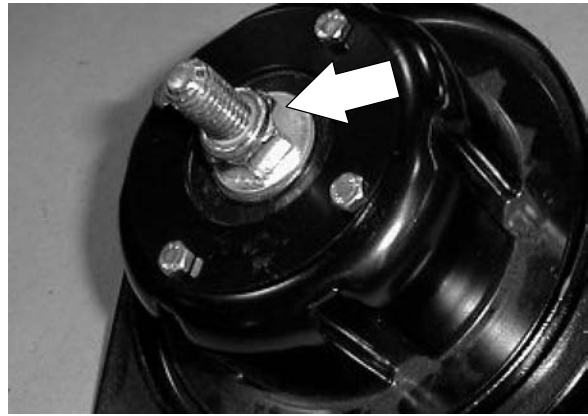

13. Reinstall the brush idler arm and idler plug into the end of the main sweep brush.

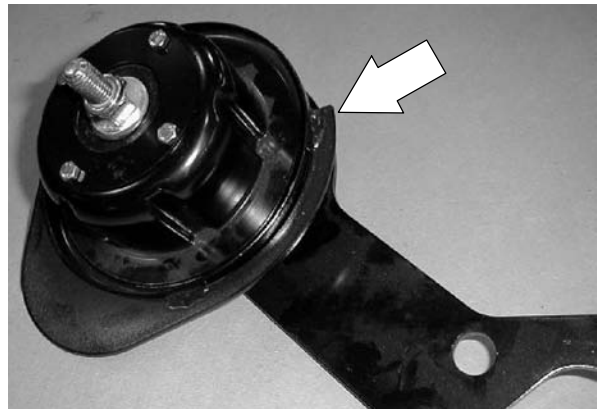

14. Reinstall the skirt plate assembly onto the frame. Reinstall the three plastic knobs and tighten.

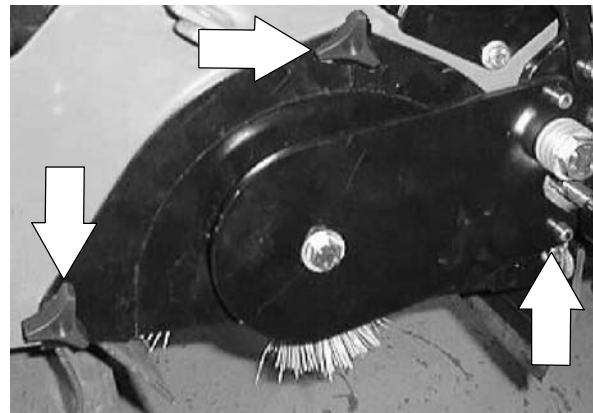

15. Position the main brush idler arm onto the brush tube. Reinstall the knob bolt and tighten tight.

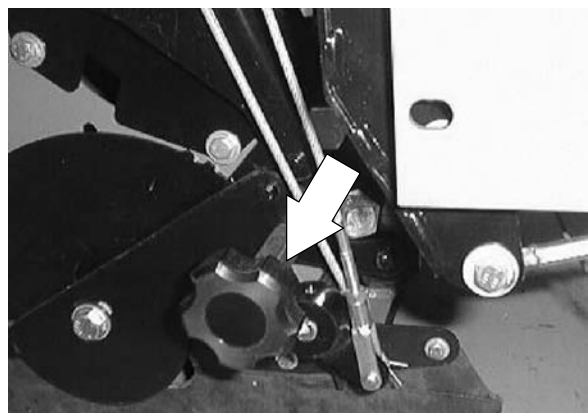

SWEEPING

16. Close the right hand brush door.

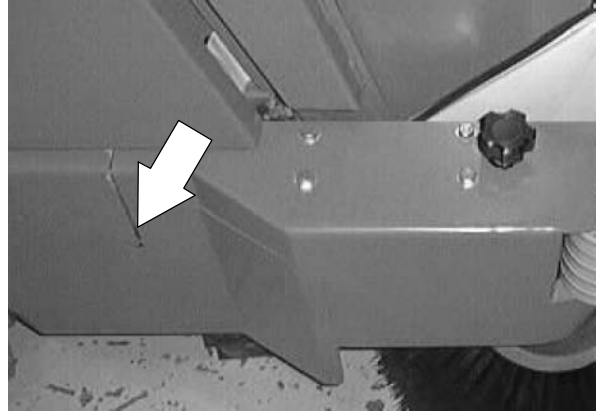

17. Operate the machine. Check the main sweep brush for proper pattern. See TO CHECK AND ADJUST MAIN BRUSH PATTERN instructions in this section.

TO REPLACE ROTARY ELEVATOR IDLER PLUG

FOR SAFETY: Before Leaving Or Servicing Machine; Stop On Level Surface, Set Parking Brake.

1. Open the right hand sweeper brush door.

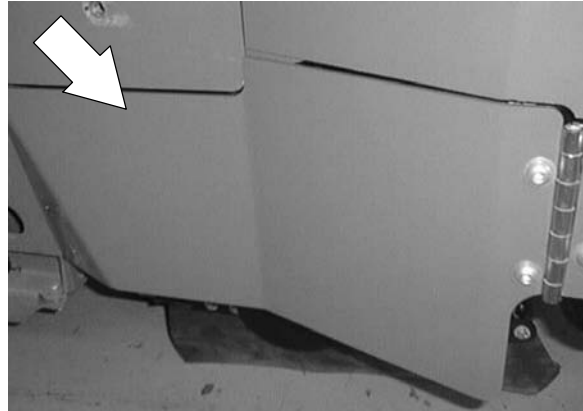

2. Remove the hex screw holding the cylindrical elevator arm to the brush tube.

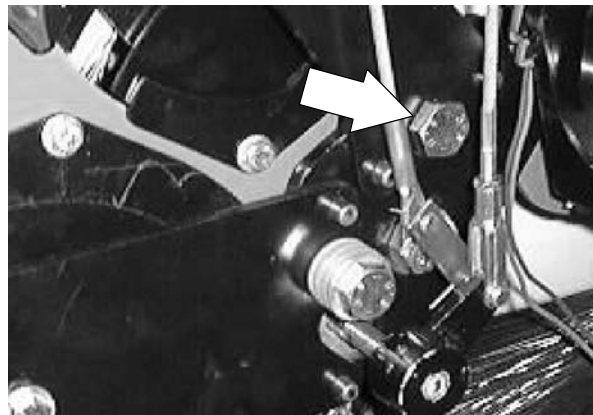

3. Remove the three nuts holding the upper skirt plate assembly to the frame.

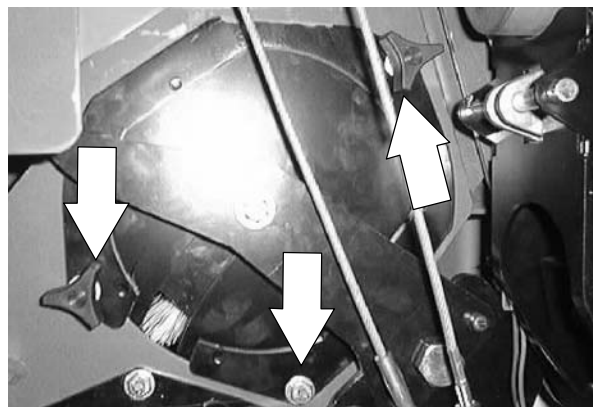

SWEEPING

4. Pull the cylindrical elevator arm and skirt assembly off the brush tube and out of the machine.

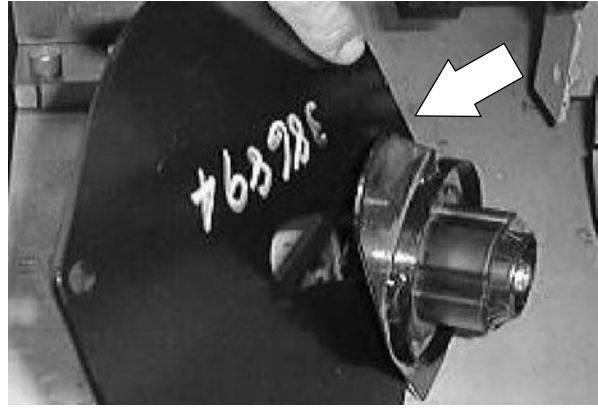

5. Remove the hex screw and nut holding the idler plug and bearing to the brush arm.



6. Remove the idler plug from the brush arm. *The idler plug may need to be pried off with screw drivers or small crow bars.* Discard the idler plug.

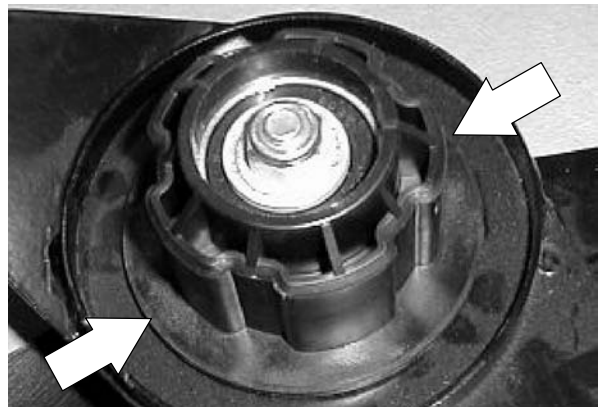

7. Use an arbor press to install the new idler plug onto the brush arm.

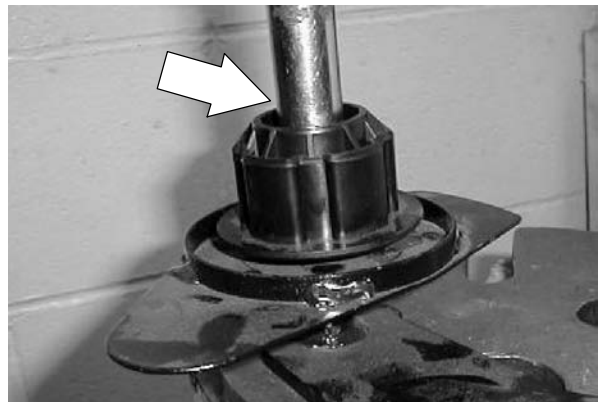

8. Reinstall the hex screw and nut. Tighten to 18 - 24 Nm (15 - 20 ft lb).

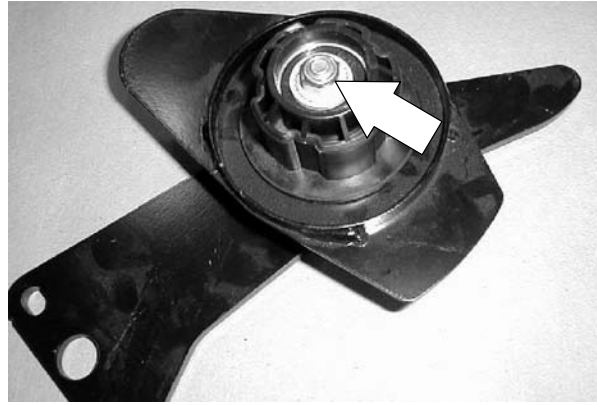

9. Reinstall the idler arm into the cylindrical elevator and onto the sweeper frame.

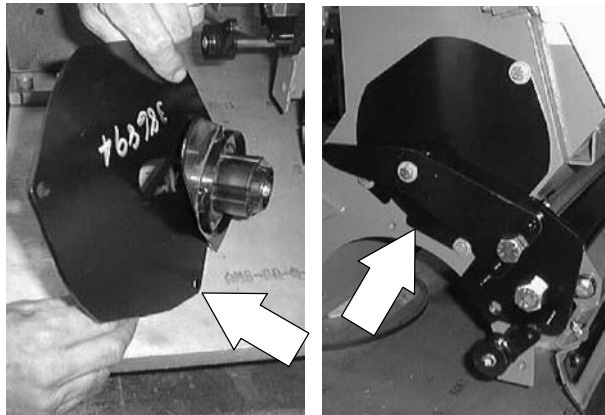

10. Position the cylindrical elevator idler arm onto the brush tube. Reinstall the hex screw and tighten tight.

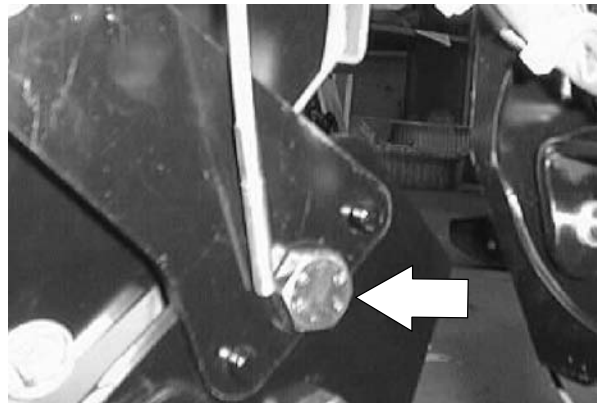

11. Reinstall the three knobs and tighten.

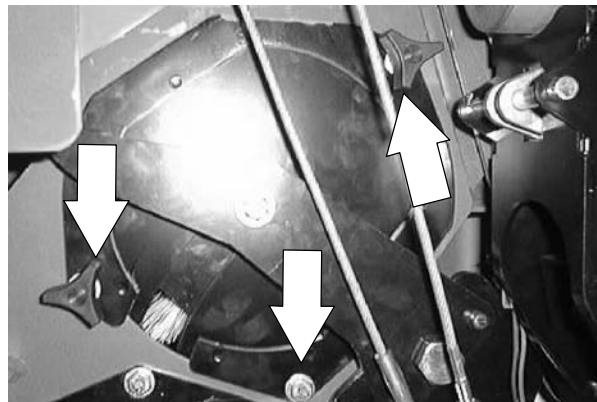

SWEEPING

12. Close the right hand brush door.

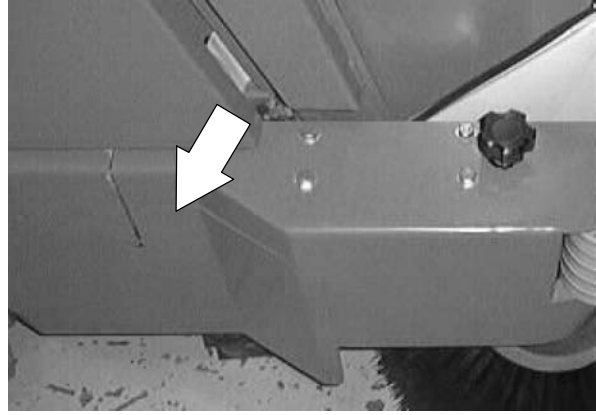

13. Operate the machine. Check the new cylindrical elevator idler plug bearing for proper operation.

TO REPLACE MAIN BRUSH TWO GROOVE SHEAVE BEARINGS

1. Remove the left side brush door.

FOR SAFETY: Before Leaving Or Servicing Machine; Stop On Level Surface, Set Parking Brake, Turn Off Machine And Remove Key.



2. Locate the main brush two groove sheave on the left side of the sweeper frame.

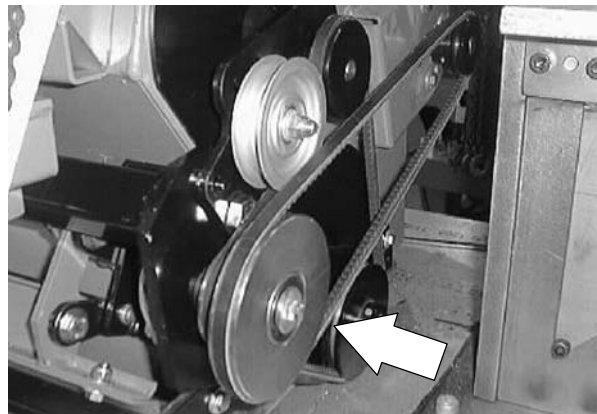

3. Loosen the four hex screws holding the main brush motor to the sweeper frame.

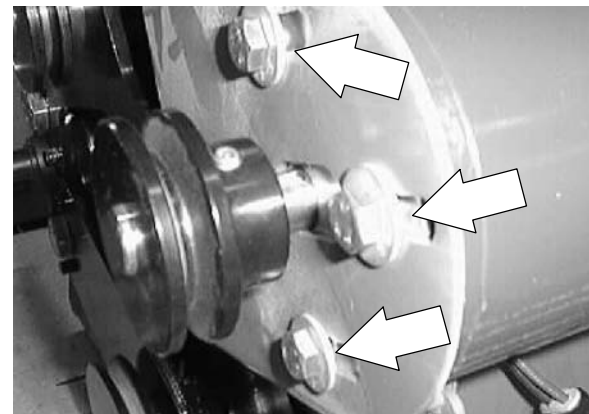

SWEEPING

4. Push the main brush motor forward.

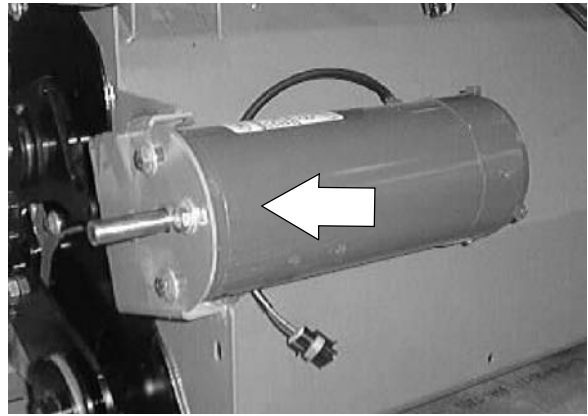

5. Remove the primary V-belt from the two groove sheave.

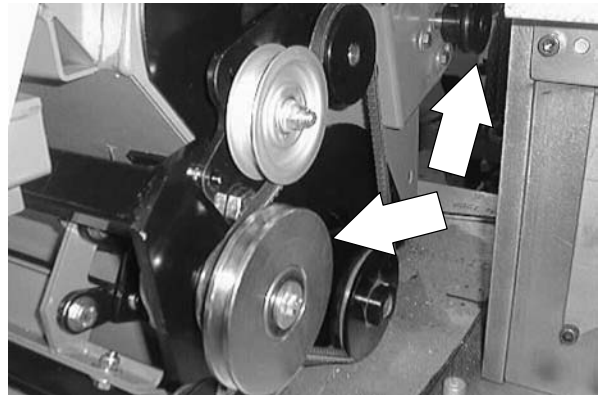

6. Loosen the nut holding the flat idler sheave to the arm. Push the sheave up.

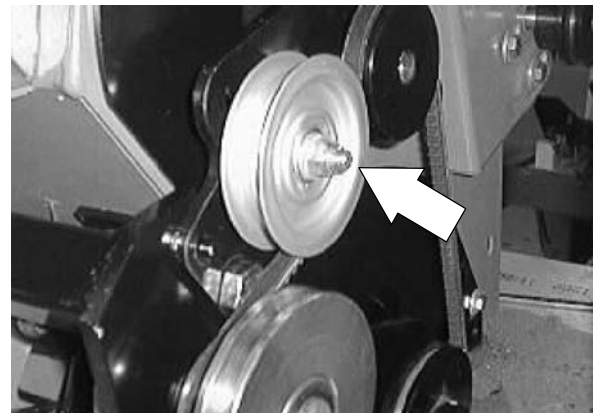

7. Remove the secondary V-belt from the two groove sheave.

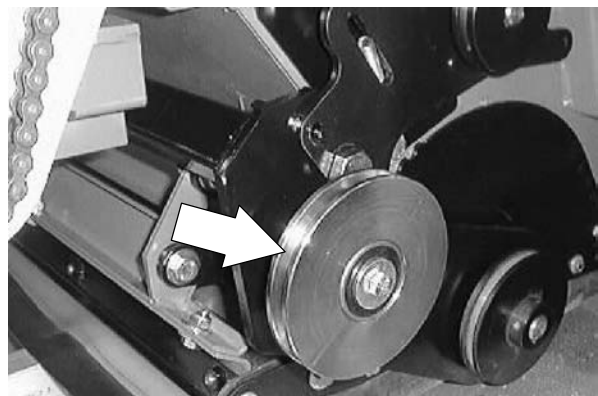

8. Remove the hex screw holding the two groove sheave to the shaft.

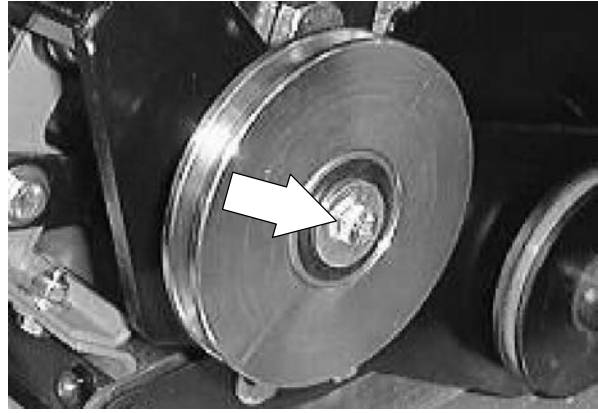

9. Use a crow bar or a puller to remove the two groove sheave from the shaft.

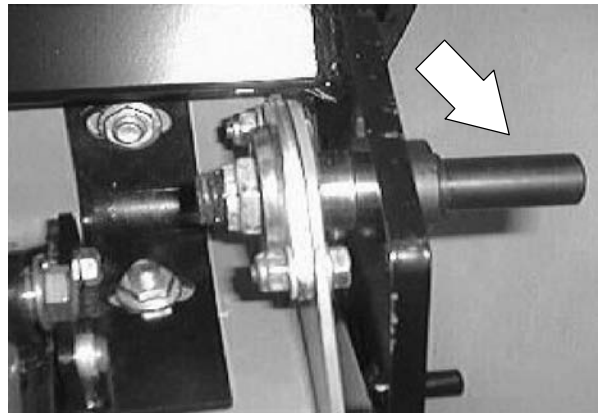

10. Use a hammer and punch to remove the bearings from the two groove sheave.

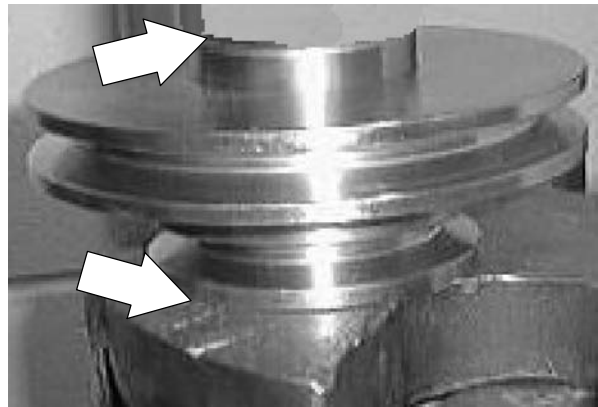

11. Use an arbor press to install the new bearings.

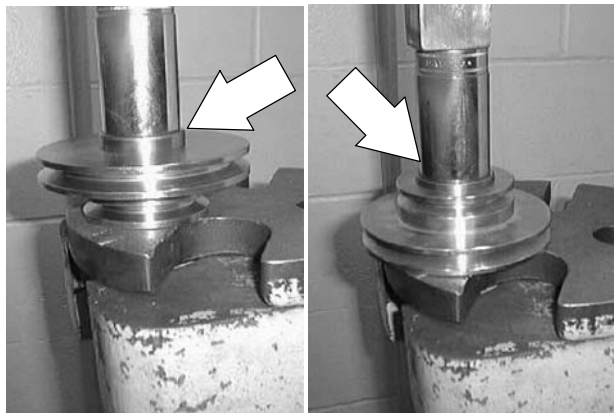

SWEEPING

12. Reinstall the two groove sheave onto the shaft. Reinstall the hex screw and tighten to 18 - 24 Nm (15 - 20 ft lb).

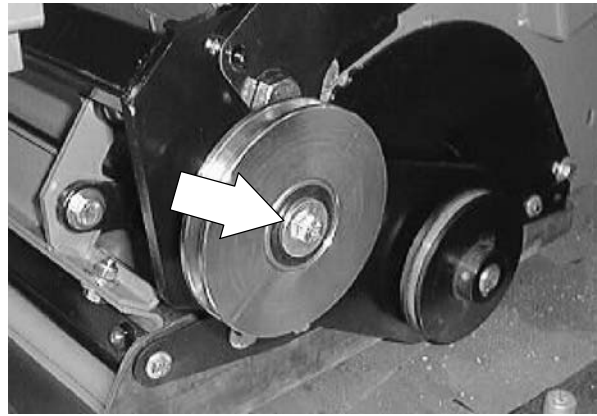

13. Install the new secondary V-belt onto the two groove sheave.

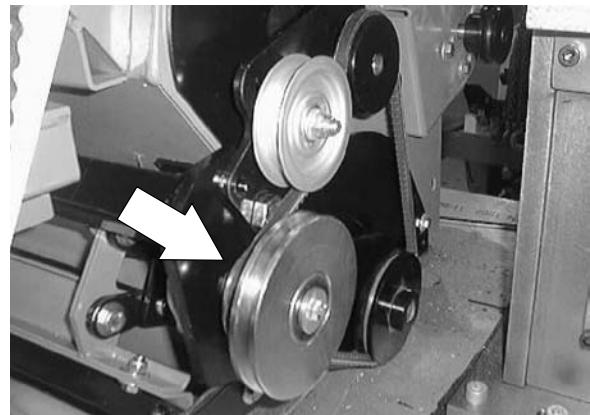

14. Pull down on the flat idler pulley to tighten the V-belt. Tighten the nut to 18 - 24 Nm (15 - 20 ft lb). *The deflection should be 3 to 7mm (0.125 to 0.25 in) when a force of 2.3 kg (5 lb) is applied at the belt midpoint.* The belt should be checked after every 50 hours of operation for wear.

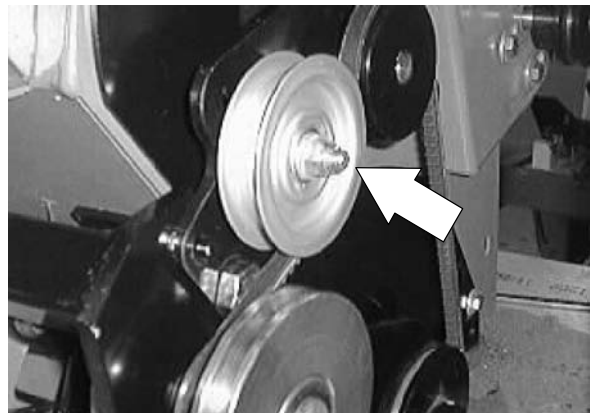

15. Position the primary V-belt onto the two groove sheave.

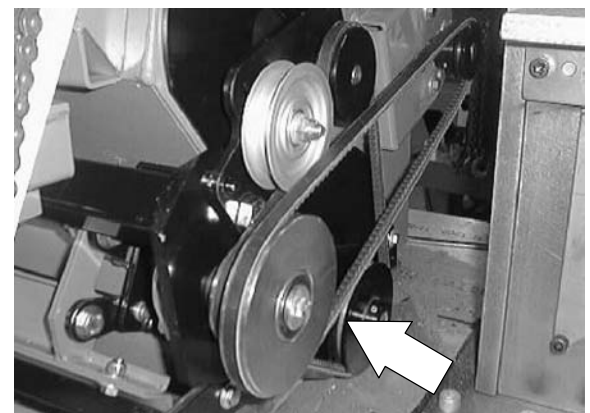

16. Pull back on the new motor until the V-belt is tight. *The deflection should be 3 to 7mm (0.125 to 0.25 in) when a force of 2.3 kg (5 lb) is applied at the belt midpoint.* The belt should be checked after every 50 hours of operation for wear.

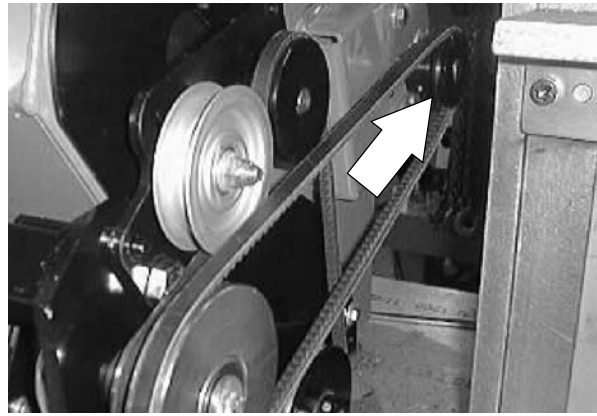

17. Tighten the four motor mount screws to 18 - 24 Nm (15 - 20 ft lb).

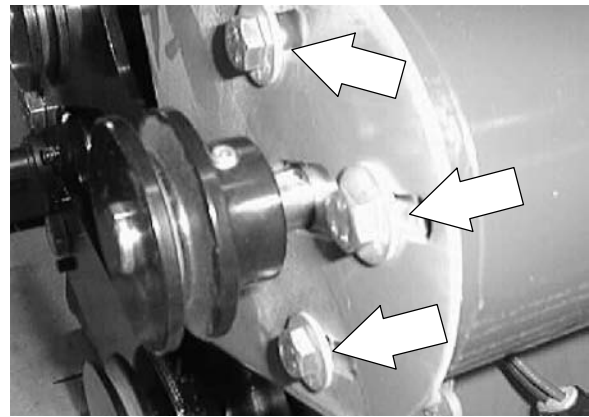

18. Reinstall the left side brush door.

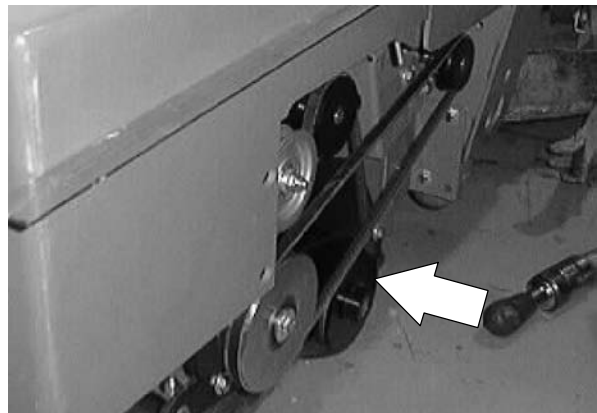

19. Reconnect the battery.

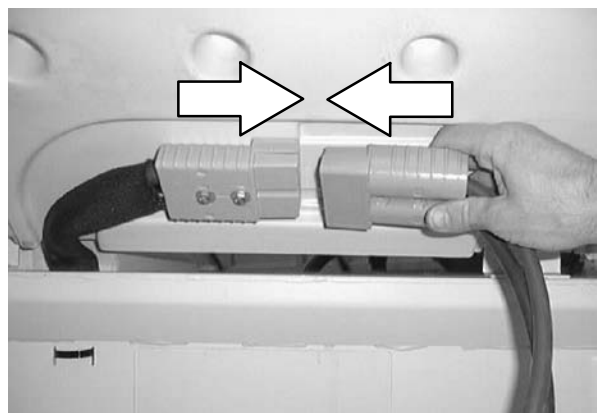

SWEEPING

20. Operate the machine. Check the two groove sheave for proper operation.

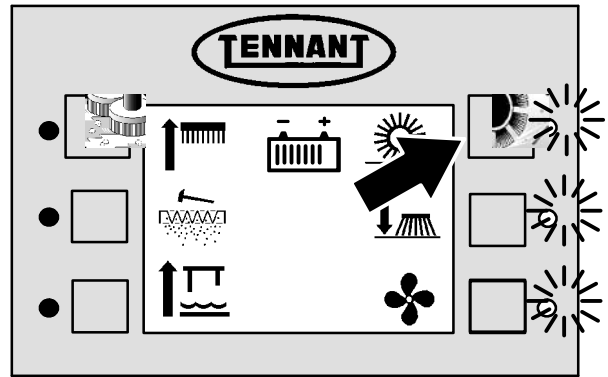

TO REPLACE MAIN BRUSH LIFT CABLE

1. Make sure the main brush is in the lowered position.
2. Raise the hopper and engage the prop arm.

FOR SAFETY: Before Leaving Or Servicing Machine; Stop On Level Surface, Set Parking Brake, Turn Off Machine And Remove Key.



3. Raise the rear cover and unplug the battery connector.

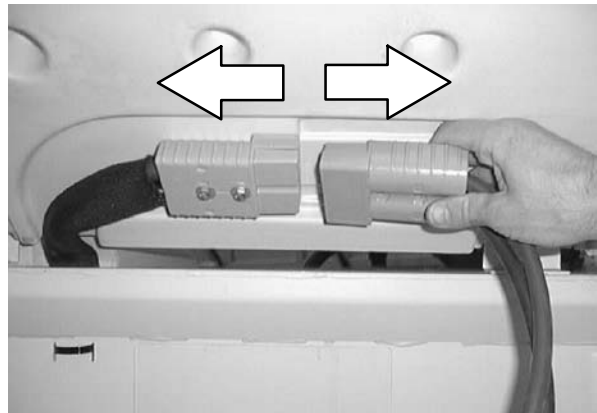

4. Remove the left side brush door.



SWEEPING

5. Un-snap the two hopper filter cover lock straps.

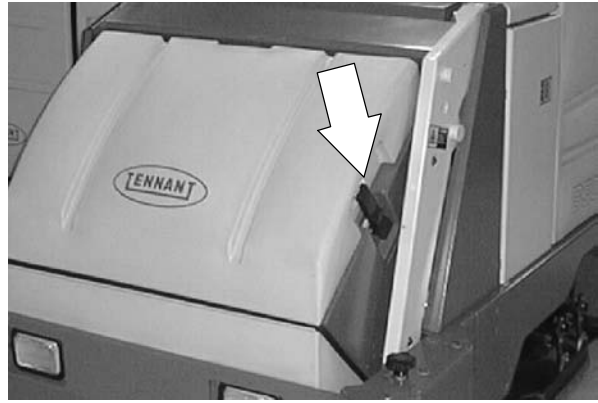

6. Remove the filter cover.

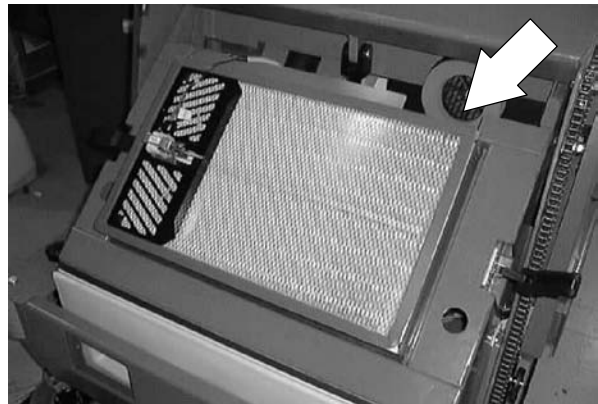

7. Disconnect the two wires from the filter shaker solenoid.

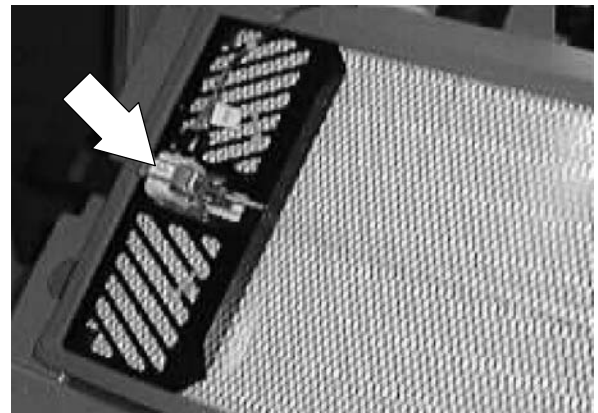

8. Remove the shaker assembly and the filter from the machine.

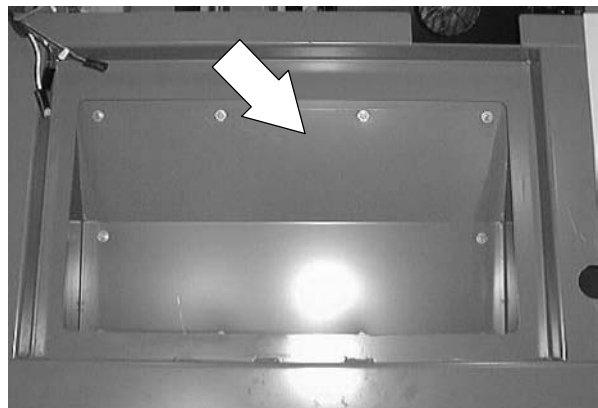

9. Remove the panel from under the filter area.

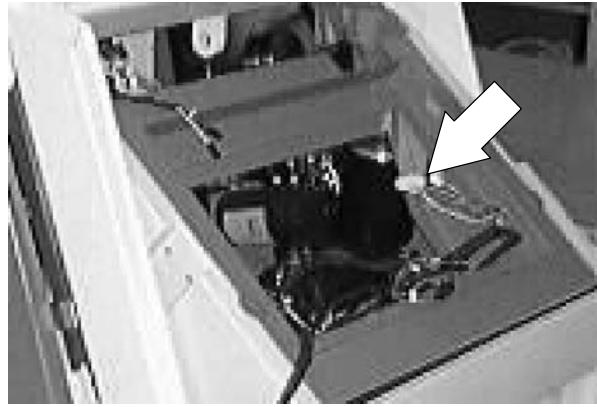

10. Locate the sweep main brush lift actuator and lift cables on the inside, front area of the sweeper frame.

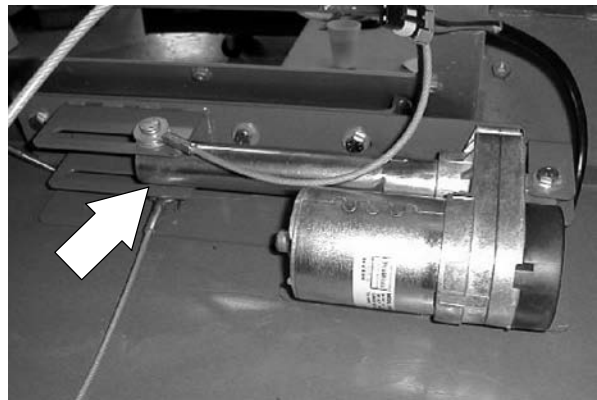

11. Remove the cotter pin from the bottom of the clevis pin at the end of the actuator tube.

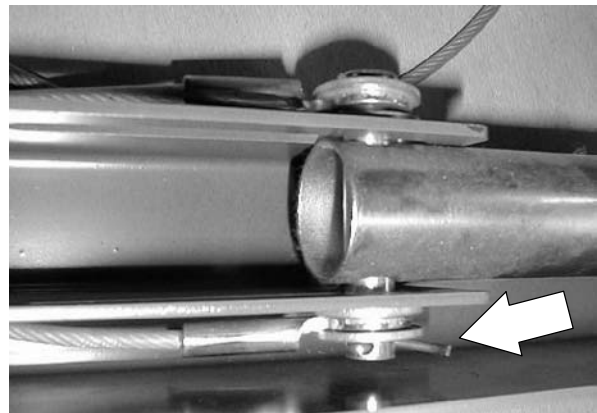

12. Remove the clevis pin and both cables.

NOTE: Note orientation of cables on the actuator.

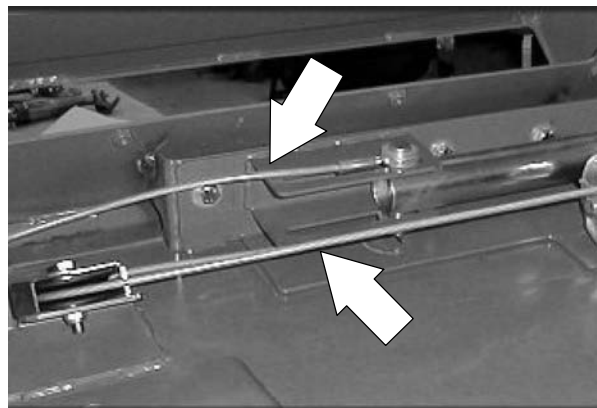

SWEEPING

13. Remove the cotter pin and clevis pin from the main brush lift cable where it attaches to the brush arm on the left side of the sweeper frame.

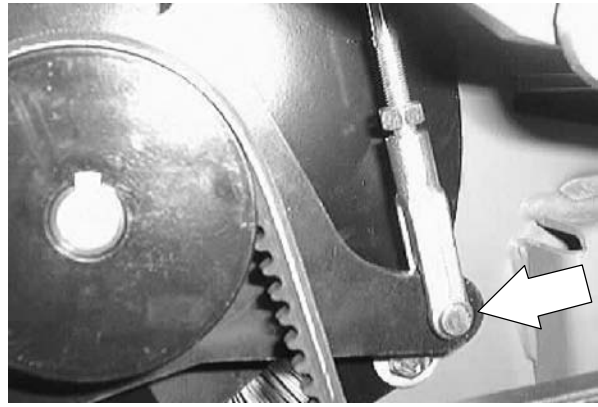

14. Remove the cable pulley from the left side of the hopper.

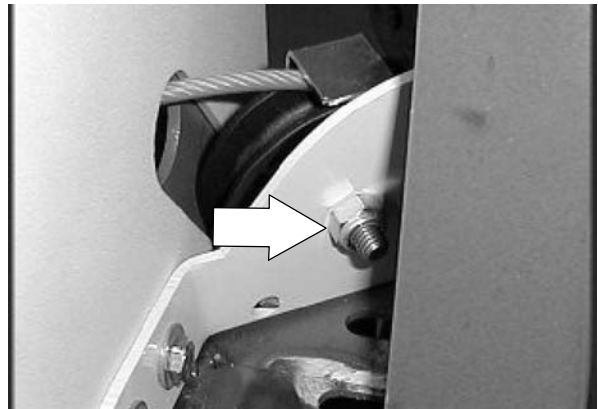

15. Remove the pulley from the left side of the sweeper frame, under the area of the debris filter.

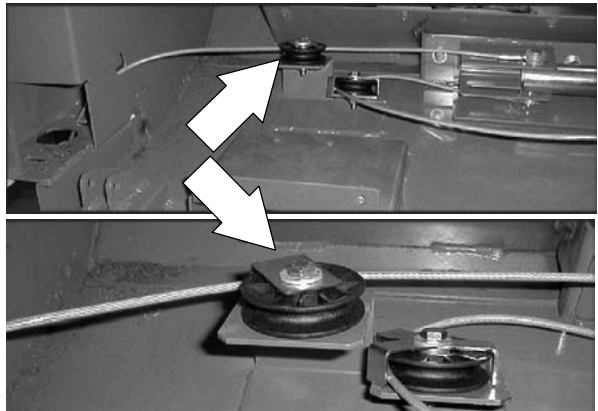

16. Pull the main brush lift cable out of the machine.

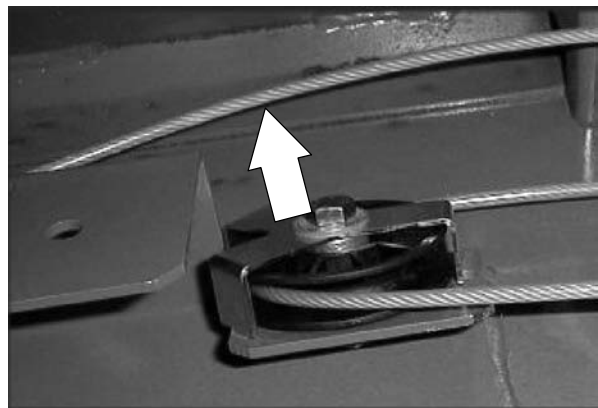

17. Remove the clevis and jam nut from the existing cable. Install the jam nut and clevis onto the new cable in the same orientation.

NOTE: Leave the jam nut loose for now.

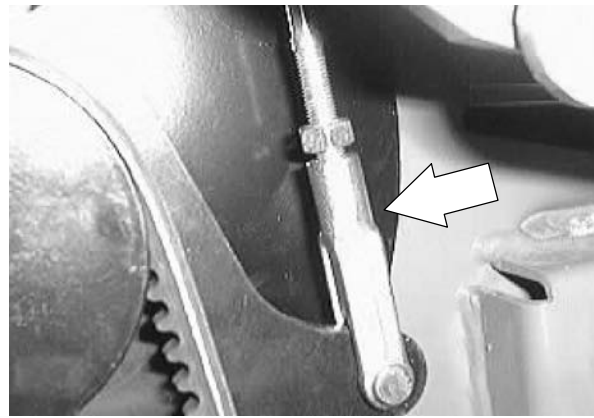

18. Route the new cable in the machine.

NOTE: The clevis end is positioned at the main brush arm.

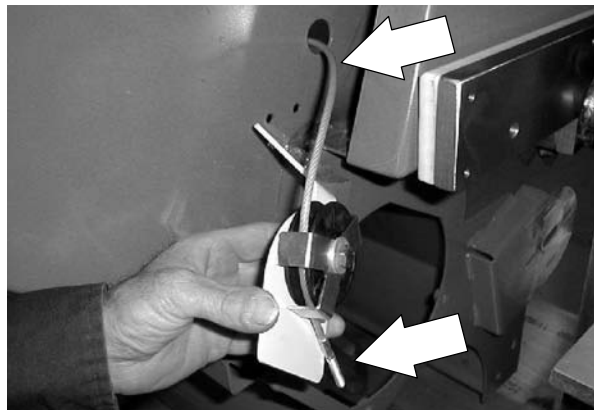

19. Reinstall both cable pulleys. *Make sure the brush lift cable is positioned in the groove of the pulley and under the retainer clip before tightening the hardware.* Tighten the hex screws to 18 - 24 Nm (15 - 20 ft lb).

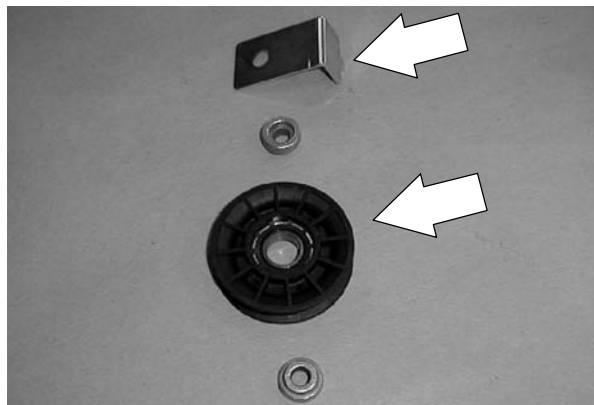

20. Reconnect the ends of the main brush lift cable and the debris flap cable to the tube end of the actuator using the clevis pin and cotter pin.

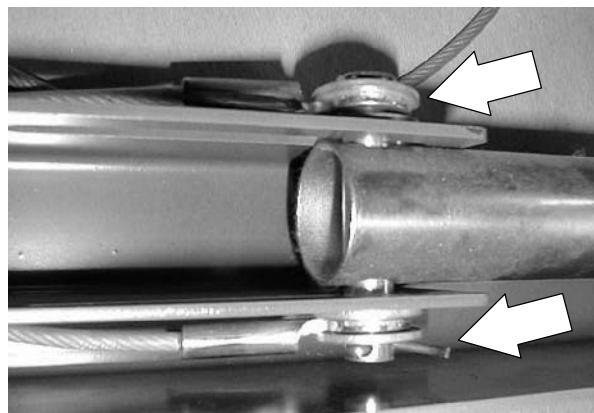

SWEEPING

21. Connect the new main brush lift cable to the brush arm on the left side of the sweeper.

NOTE: Reuse the clevis pin and cotter pin.

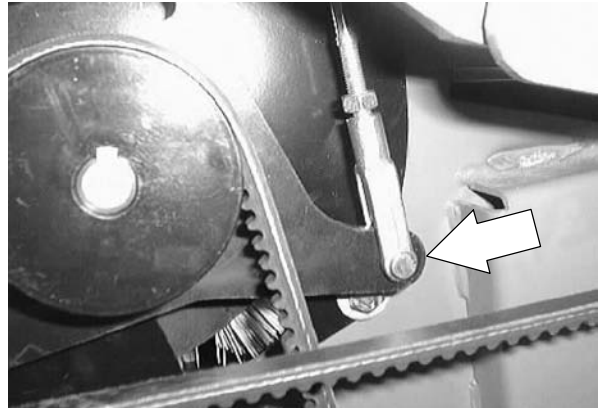

22. Reinstall the sweeper panel.

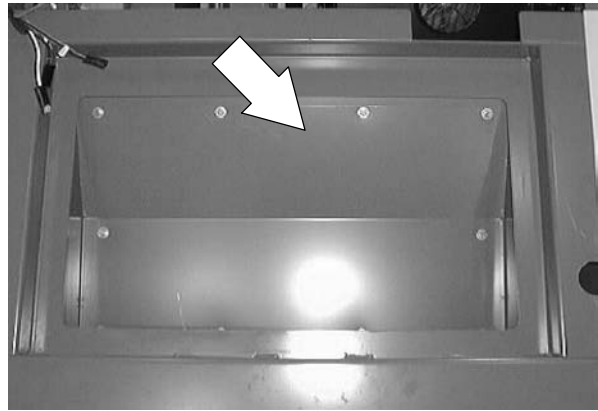

23. Install the debris filter into the filter housing.

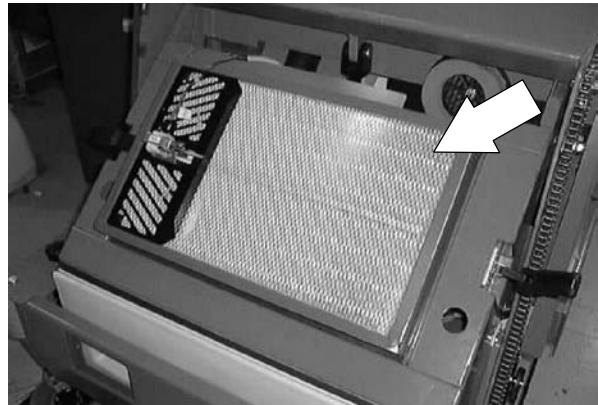

24. Install the shaker assembly onto the new filter.

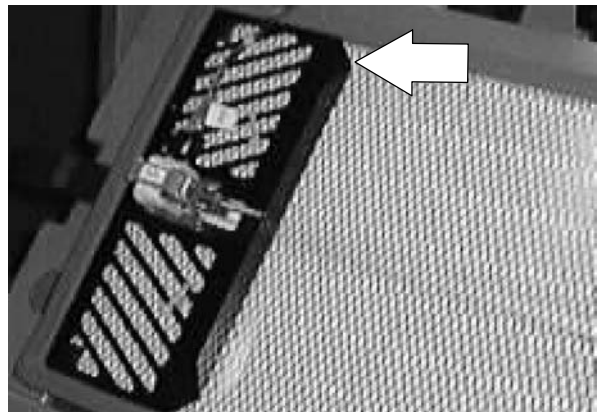

25. Route the shaker wires into the slits in the filter seal.

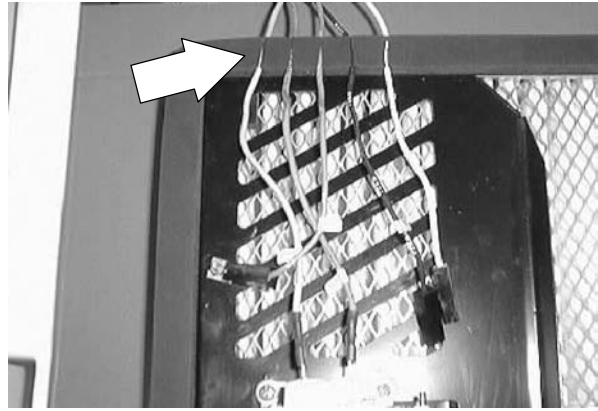

26. Reinstall the filter cover. Secure the filter cover with the two lock straps.

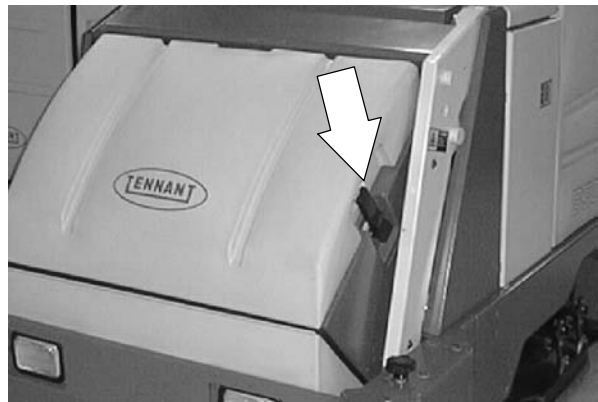

27. Reconnect the battery.

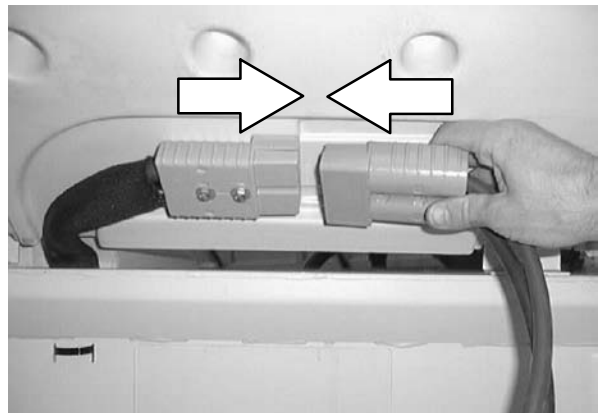

28. Disengage the prop arm and lower the hopper.

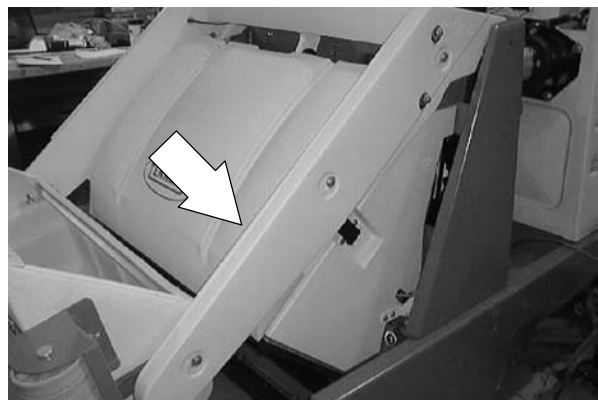

SWEEPING

29. Operate the machine. Check the main brush lift cable for proper operation.

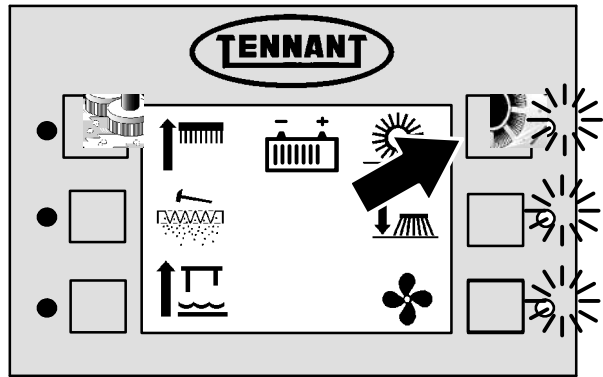

30. Reinstall the left side brush door.



**TO REPLACE LARGE DEBRIS SKIRT
AUTOMATIC LIFT CABLE**

1. Make sure the main brush is in the lowered position.
2. Raise the hopper and engage the prop arm.

FOR SAFETY: Before Leaving Or Servicing Machine; Stop On Level Surface, Set Parking Brake, Turn Off Machine And Remove Key.



3. Raise the rear cover and unplug the battery connector.

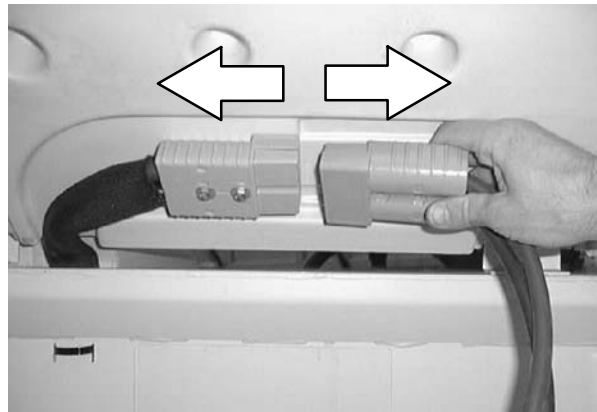

4. Open the right side brush door.

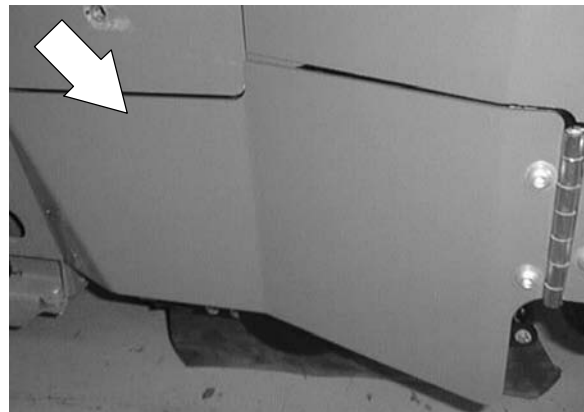

SWEEPING

5. Un-snap the two hopper filter cover lock straps.

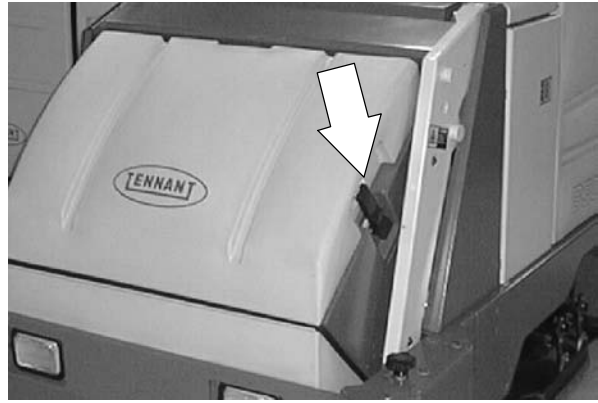

6. Remove the filter cover.

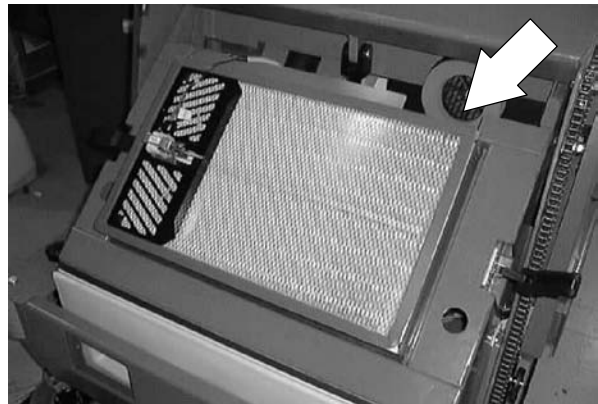

7. Disconnect the two wires from the filter shaker solenoid.

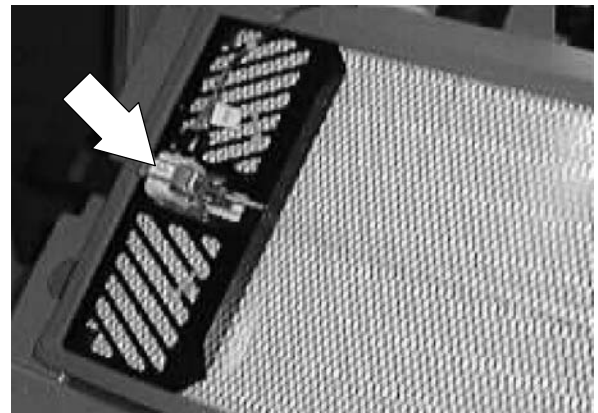

8. Remove the shaker assembly and the filter from the machine.

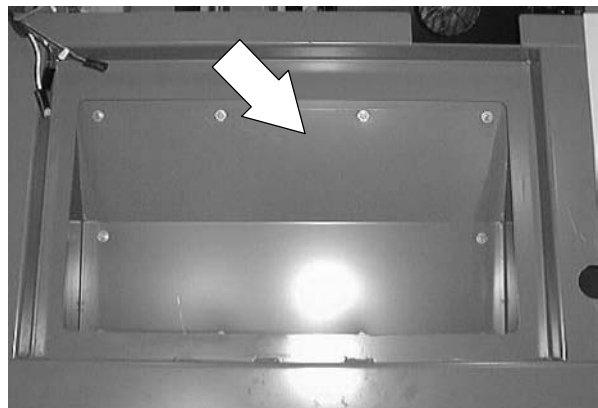

9. Remove the panel from under the filter area.

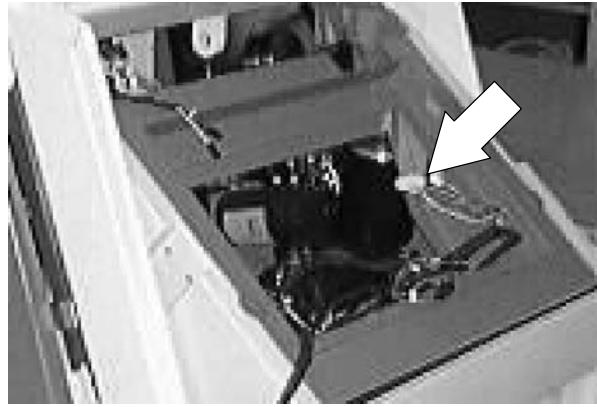

10. Locate the sweep main brush lift actuator and lift cables on the inside, front area of the sweeper frame.

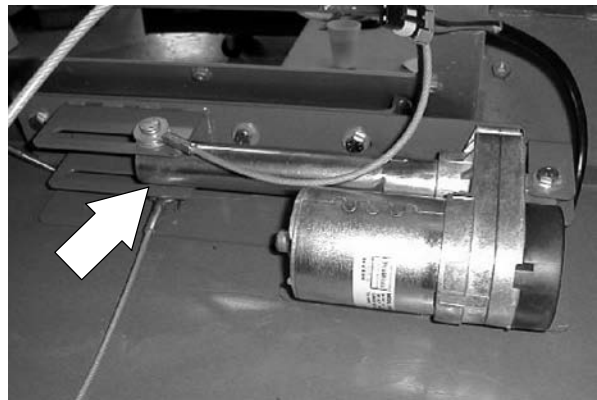

11. Remove the cotter pin from the bottom of the clevis pin at the end of the actuator tube.

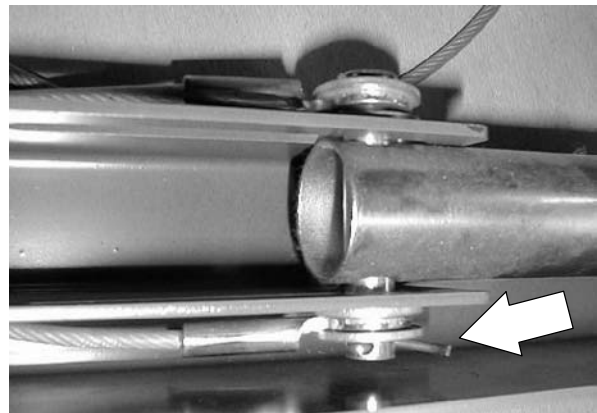

12. Remove the clevis pin and both cables.

NOTE: Note orientation of cables on the actuator.

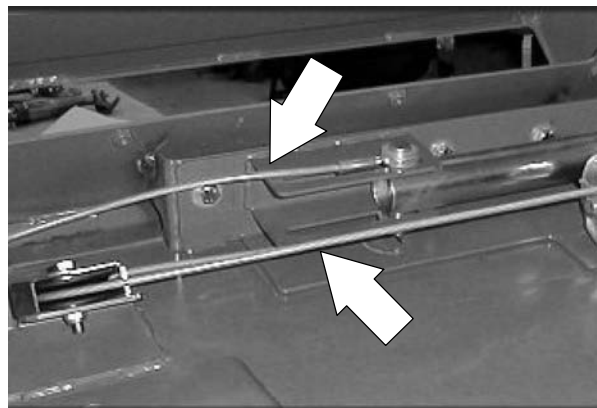

SWEEPING

13. Disconnect the large debris skirt lift cable at the debris skirt arm on the right side of the sweeper frame.

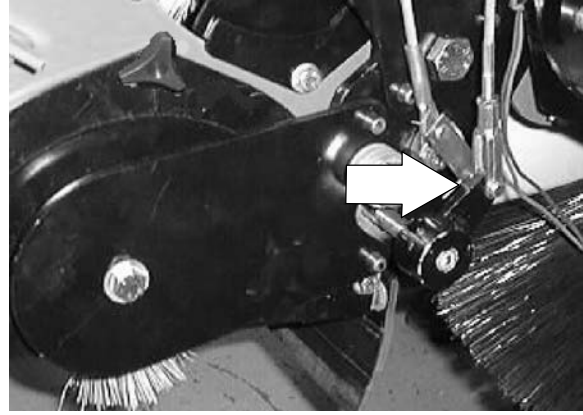

14. Remove the cable pulley from the right side of the hopper.

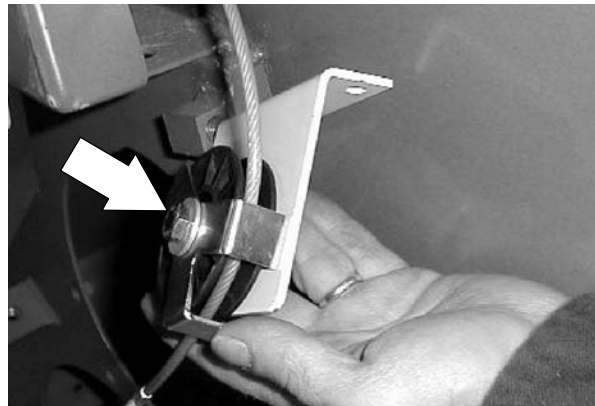

15. Remove the pulley from the right side of the sweeper frame, under the area of the debris filter.

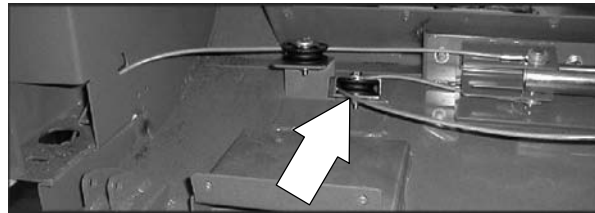

16. Pull the main brush lift cable out of the machine.

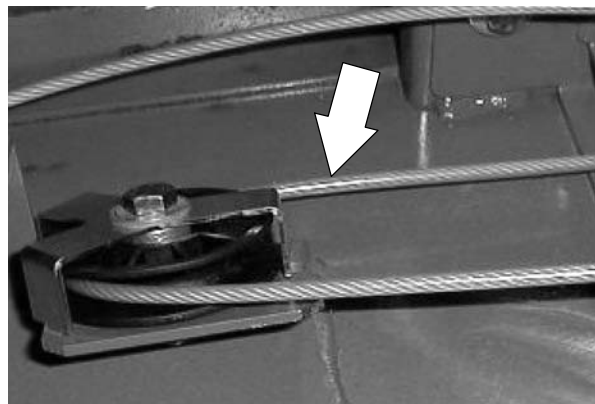

17. Remove the clevis and jam nut from the existing cable. Install the jam nut and clevis onto the new cable in the same orientation.

NOTE: Leave the jam nut loose for now.

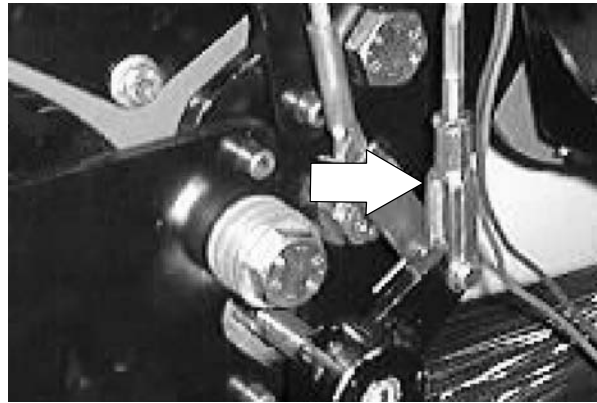

18. Route the new cable in the machine. *The clevis end is positioned at the main brush arm.*

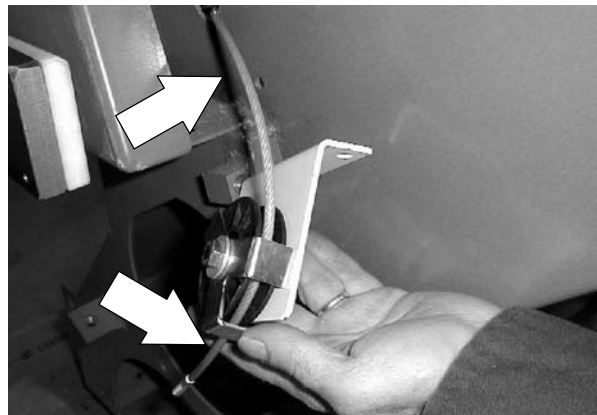

19. Reinstall both cable pulleys. *Make sure the brush lift cable is positioned in the groove of the pulley and under the retainer clip before tightening the hardware.* Tighten the hex screws to 18 - 24 Nm (15 - 20 ft lb).

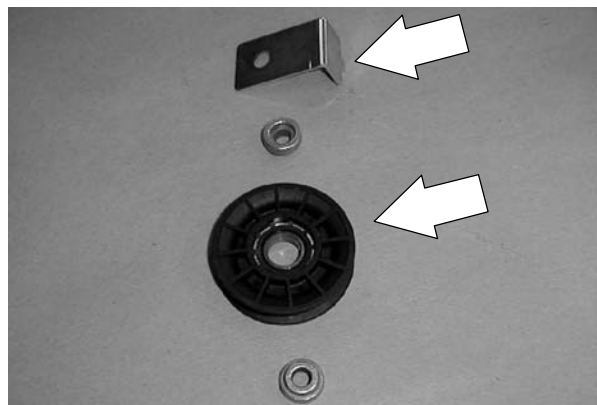

20. Reconnect the ends of the large debris skirt lift cable and the main brush cable to the tube end of the actuator using the clevis pin and cotter pin.

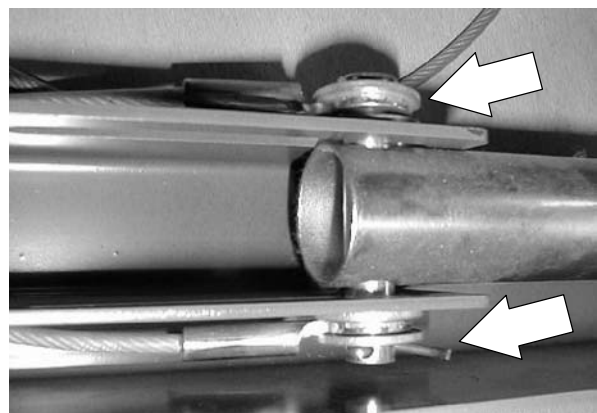

SWEEPING

21. Connect the new debris skirt lift cable to the arm on the right side of the sweeper.

NOTE: Reuse the clevis pin and cotter pin.

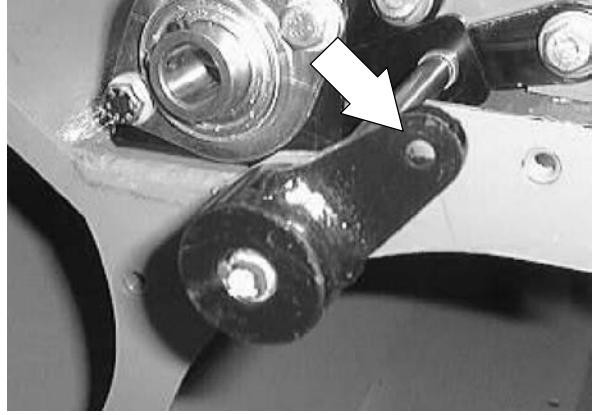

22. Reinstall the sweeper panel.

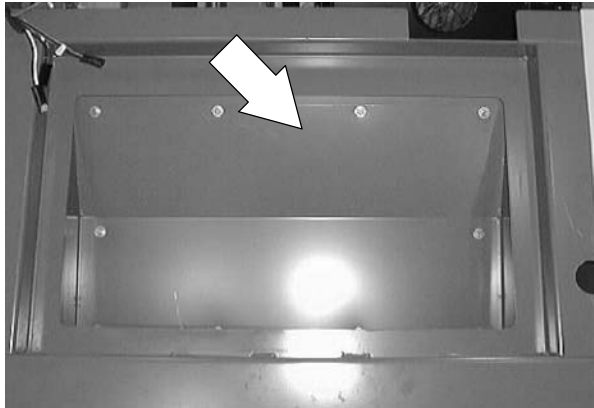

23. Install the debris filter into the filter housing.

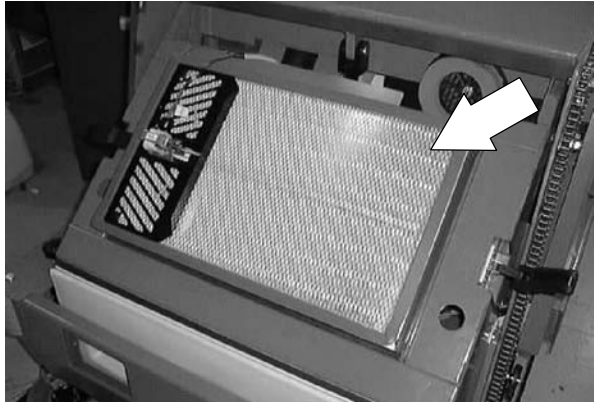

24. Install the shaker assembly onto the new filter.

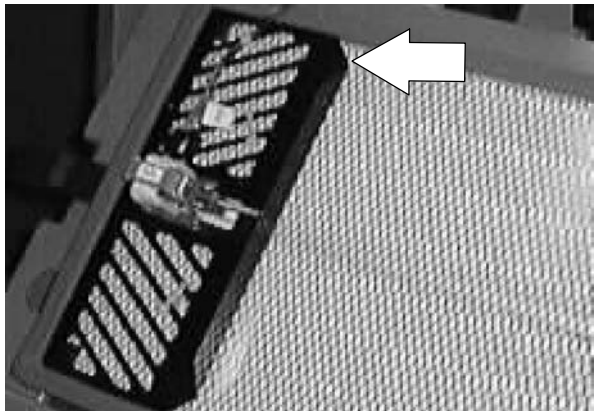

25. Route the shaker wires into the slits in the filter seal.

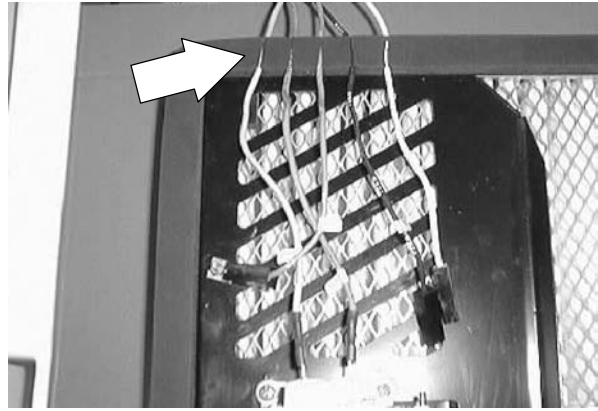

26. Reinstall the filter cover. Secure the filter cover with the two lock straps.

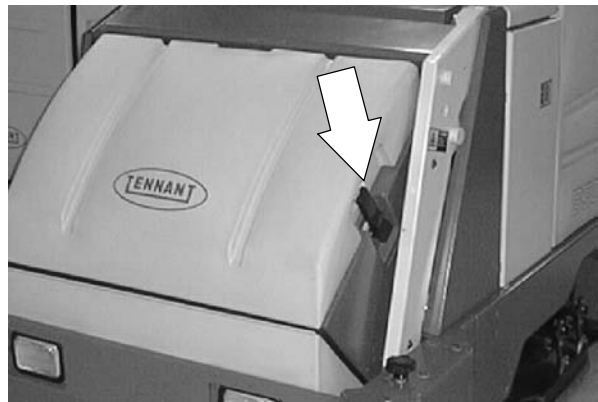

27. Reconnect the battery.

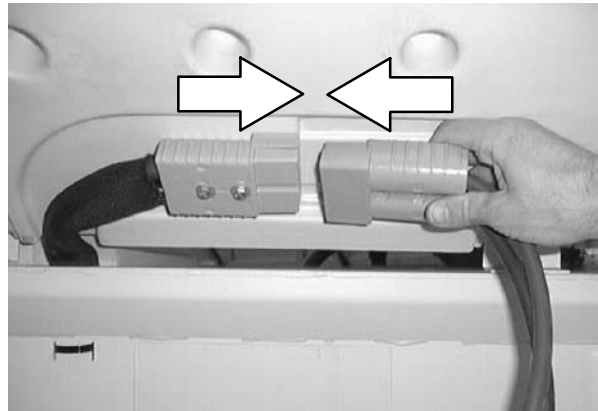

28. Disengage the prop arm and lower the hopper.

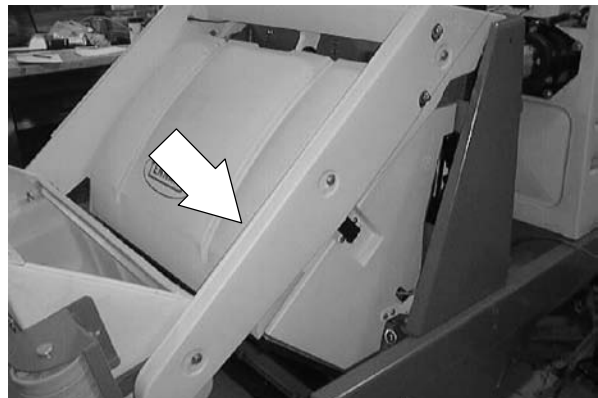

SWEEPING

29. Operate the machine. Check the large debris skirt lift cable for proper operation.

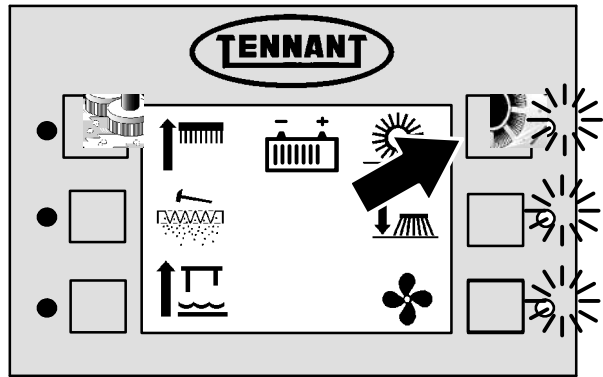

30. Reinstall the right side brush door.

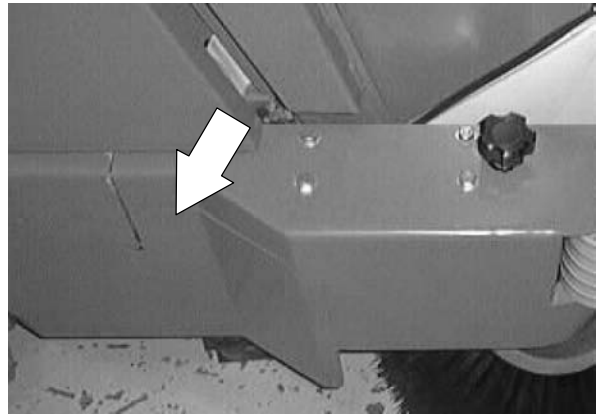

SIDE SWEEPING BRUSH

The side sweeping brush(es) sweep debris into the path of the main brush. Check the side brush(es) daily for wear or damage. Remove any string or wire found tangled on the side brush(es) or side brush drive shafts.

The side sweeping brush(es) pattern should be checked periodically. The side brush bristles should contact the floor in a 10 o'clock to 3 o'clock pattern when the brush is in motion. The side brush pattern adjustment is made by turning the side brush adjustment knob.

The side sweeping brush(es) should be replaced when the remaining brush bristle measures 50 mm (2 in) or less in length.

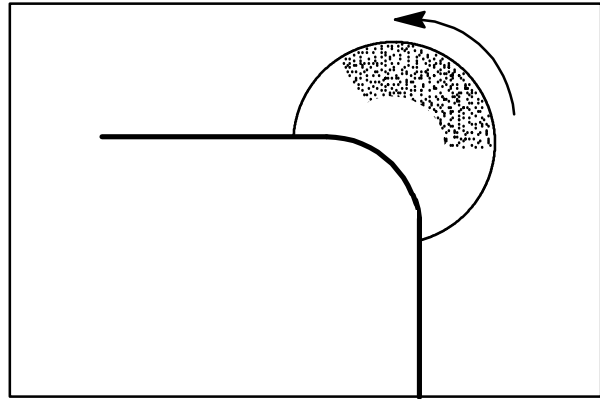

03376

SWEEPING

TO ADJUST SIDE BRUSH PATTERN

FOR SAFETY: Before Leaving Or Servicing Machine; Stop On Level Surface, Set Parking Brake.

TO ADJUST SIDE BRUSH PATTERN SIDE TO SIDE

1. With the side brush in the raised position, loosen the two bolts holding the side brush in the side to side position.

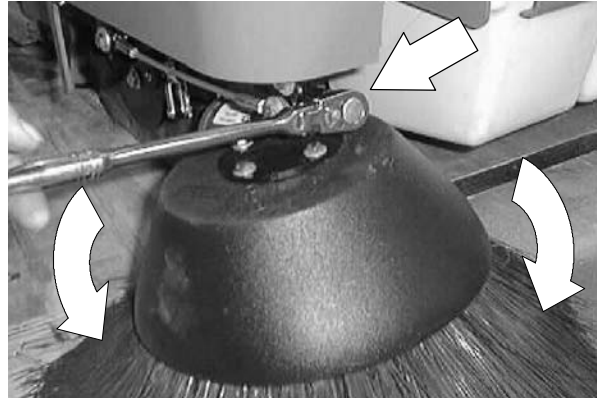

2. Pivot the side brush assembly to the position desired. Tighten the hardware to 18 - 24 Nm (15 - 20 ft lb).

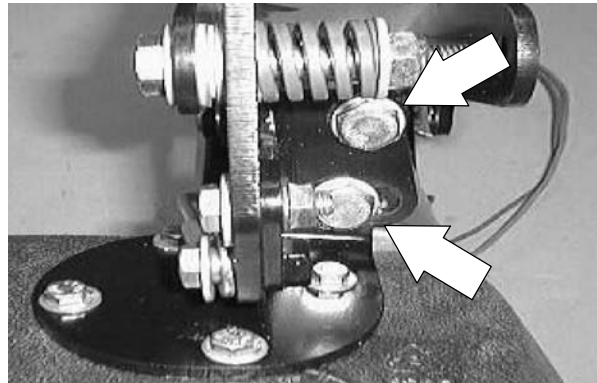

TO ADJUST SIDE BRUSH PATTERN FRONT TO BACK

1. With the side brush in the raised position, loosen the two bolts holding the side brush in the front to back position.
2. Pivot the side brush assembly to the position desired. Tighten the hardware to 18 - 24 Nm (15 - 20 ft lb).

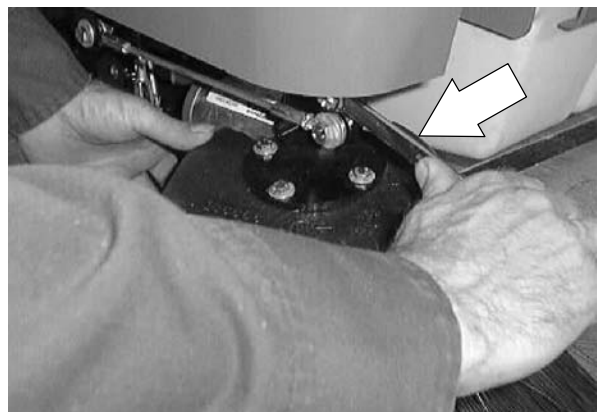

TO REPLACE SIDE BRUSH

FOR SAFETY: Before Leaving Or Servicing Machine; Stop On Level Surface, Set Parking Brake.

1. Make sure the side brush is in the raised position.

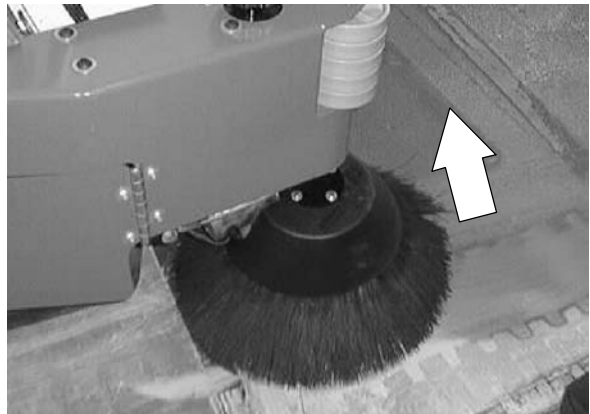

2. Reach under the side brush and remove the hair pin from the side brush motor shaft.



3. Remove the side brush, brush plate, and shaft hub.



SWEEPING

4. Position the shaft hub and brush plate onto the new side brush.

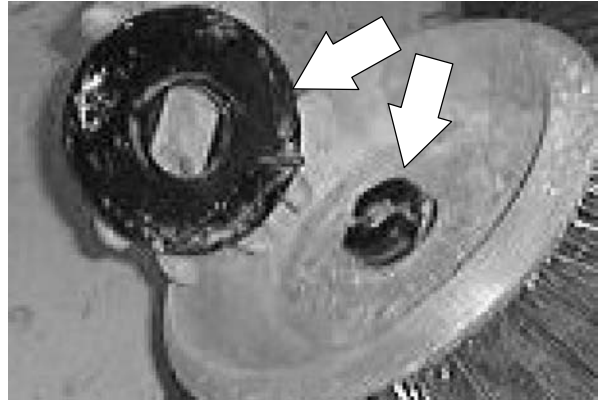

5. Position the new side brush, shaft hub, and brush plate onto the side brush motor shaft. Reinstall the hair pin.

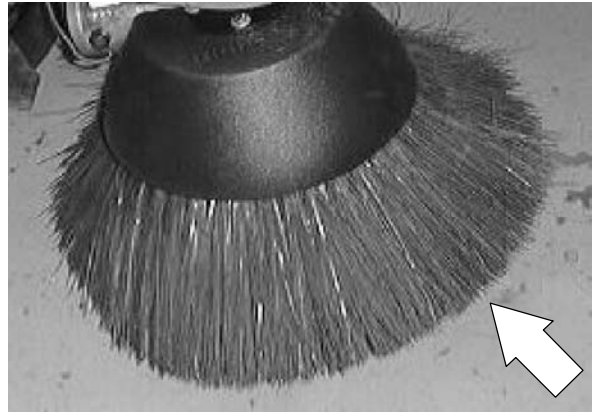

6. Operate the side brush. Check for proper operation.

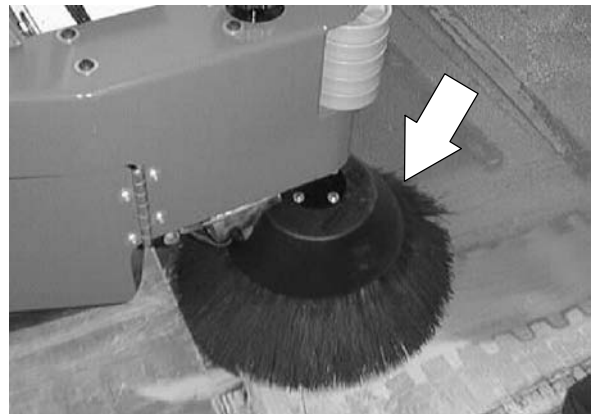

SKIRTS AND SEALS

DEBRIS SKIRT

The debris skirt is located at the front of the sweeper frame. The debris skirt is lifted to allow larger debris to pass under the front of the sweeper and into the main sweep brush.

The debris skirt can be lifted manually with the lift handle on the right hand side of the lift arm towers.

The debris skirt is lifted automatically when the main brush is raised.

TO REPLACE DEBRIS SKIRT

FOR SAFETY: Before Leaving Or Servicing Machine; Stop On Level Surface, Set Parking Brake.

1. Raise the hopper and engage the prop arm.

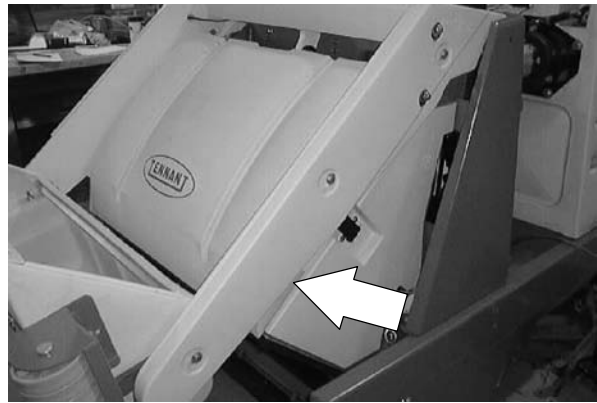

2. Locate the debris skirt at the front, lower edge of the sweeper frame.

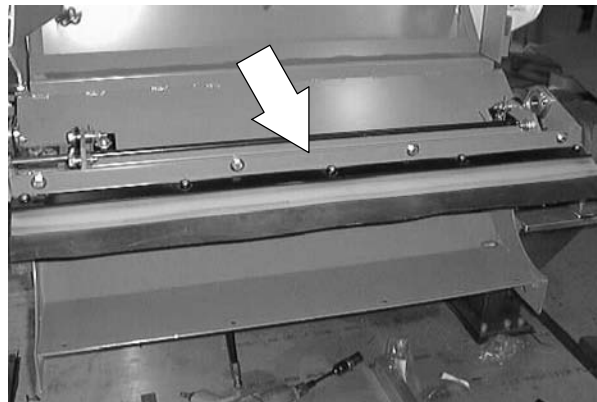

SWEEPING

3. Remove the five hex screws holding the debris skirt and flap strip to the angle mount.

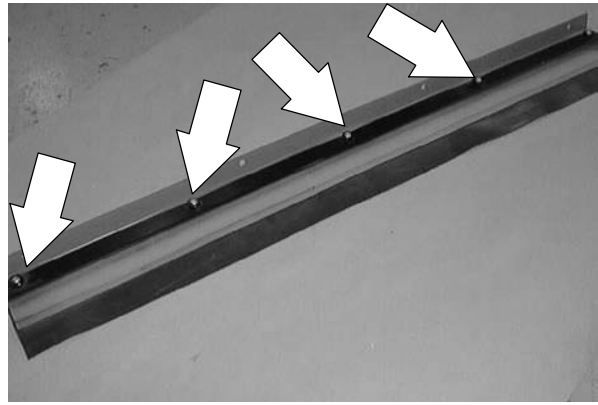

4. Pull the debris skirt off the angle mount. Retain the flap strip.

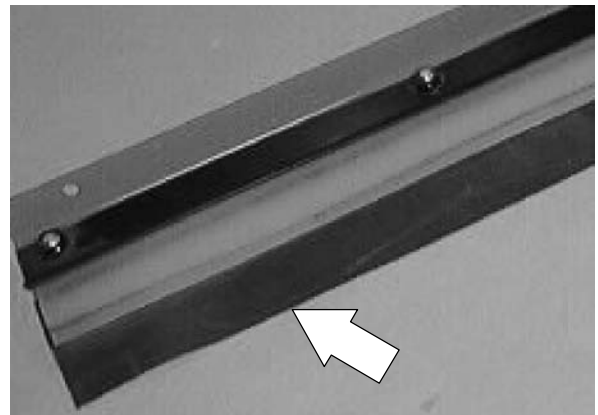

5. Install the new debris skirt and existing flap strip onto the angle mount.

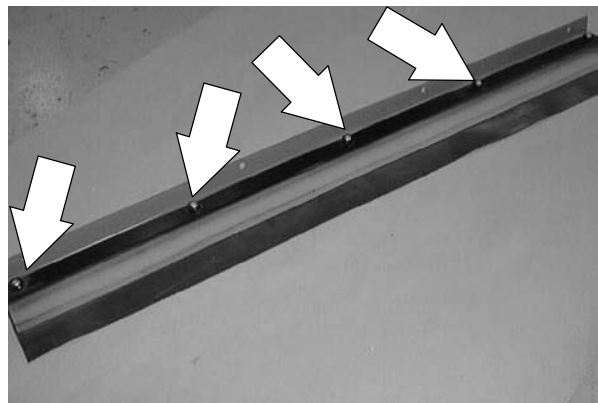

6. Reinstall the five hex screws and tighten only until the rubber starts to deform slightly.

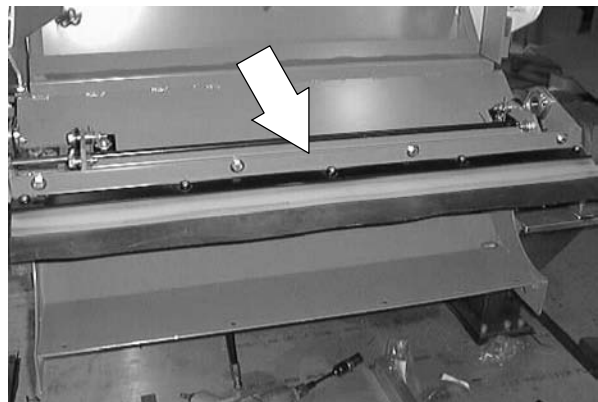

7. Disengage the prop arm and lower the hopper. Operate the machine. Check the debris skirt for proper operation.

RECIRCULATION SKIRTS

The recirculation skirts are used to contain the dirt and debris that enters the sweep brush chamber. Once the dirt and debris has been contained it can be picked up by the main sweep brush and then the rotary elevator and deposited into the hopper.

Check the recirculation skirts for any damage. If the either skirt is worn or torn - replace for optimum sweeping performance.

TO REPLACE REAR SKIRT

1. Remove the main sweep brush. See TO REPLACE MAIN SWEEP BRUSH instructions in this section.

2. Remove the four hex screws and nuts holding the two skirts and the skirt retainer to the sweeper frame.

3. Remove the existing recirculation skirts and retainers from the machine. Discard the skirts.

4. Position the new recirculation skirts and existing retainers onto the sweeper frame. Reinstall the four hex screws and tighten only until the rubber starts to deform slightly.

5. Reinstall the main sweep brush. See TO REPLACE MAIN SWEEP BRUSH instructions in this section. Operate the machine. Check the recirculation skirts for proper operation.

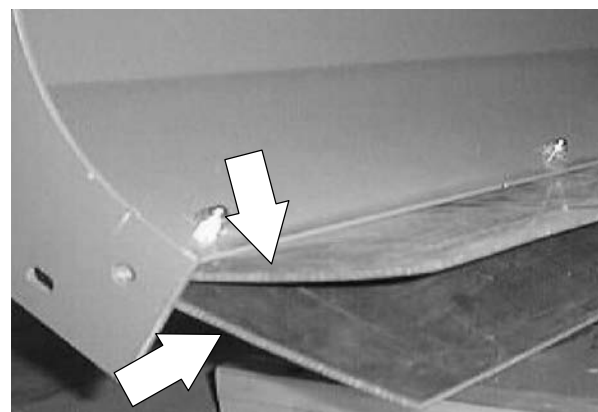
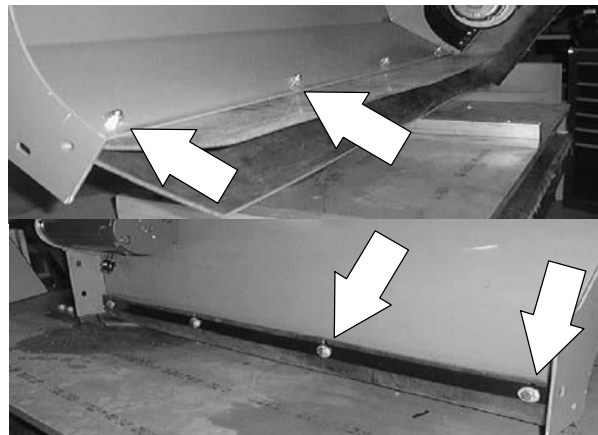
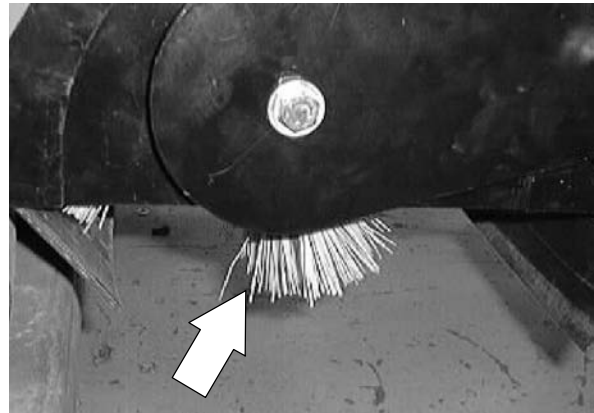

SWEEPING

HOPPER SEALS

The hopper seals are located under the filter chamber. The hopper seals are used to create an air tight connection between the hopper and the filter chamber when the hopper is in the lowered position.

Raise the hopper and inspect the hopper seals daily. Replace any torn or damaged seals for optimum sweeping performance.

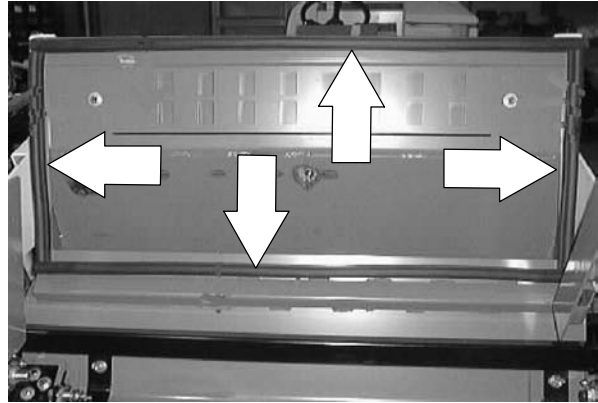

VACUUM FAN

The sweeping vacuum fan is located on the back of the sweeper assembly frame and is powered by an electric motor and V-belt. The fan is used during sweeping to control dusting by pulling air through the filter.

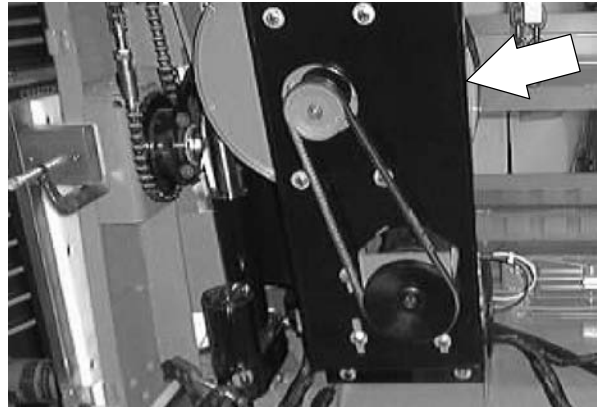
**HOPPER VACUUM FAN SEAL**

The vacuum fan seal is located between the hopper cover and vacuum fan inlet. Replace the vacuum fan seal if it becomes damaged.

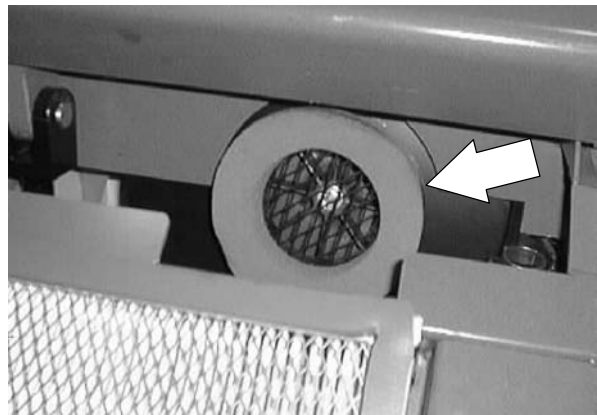

SWEEPING

TO REMOVE VACUUM FAN HOUSING

FOR SAFETY: Before Leaving Or Servicing Machine; Stop On Level Surface, Set Parking Brake.

1. Raise the hopper and engage the prop arm.



2. Raise the rear cover and unplug the battery connector.

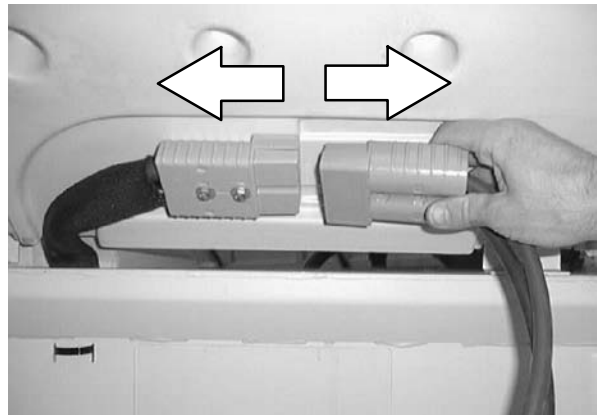

3. Open the top cover and side door.



4. Remove the hopper cover, debris filter, and access panel.

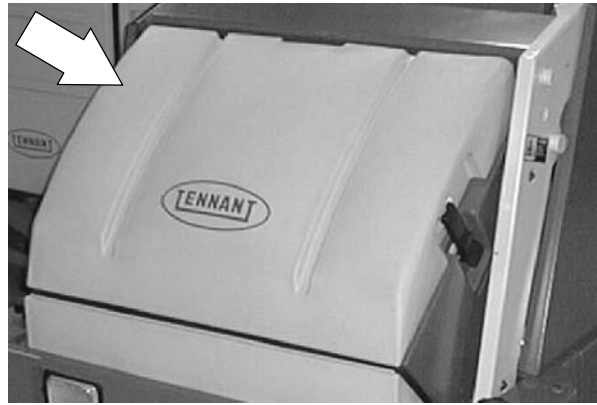

5. Loosen the three hex screws holding the vacuum fan electric motor mount plate to the frame.

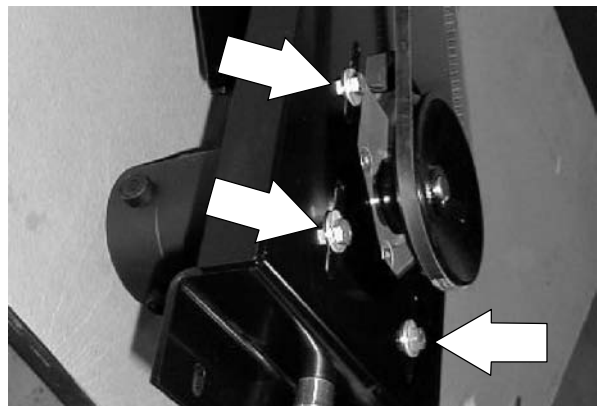

6. Loosen, then remove the belt adjustment screw on the bottom of the vacuum fan assembly mount bracket. *This will give slack to the V-belt.*

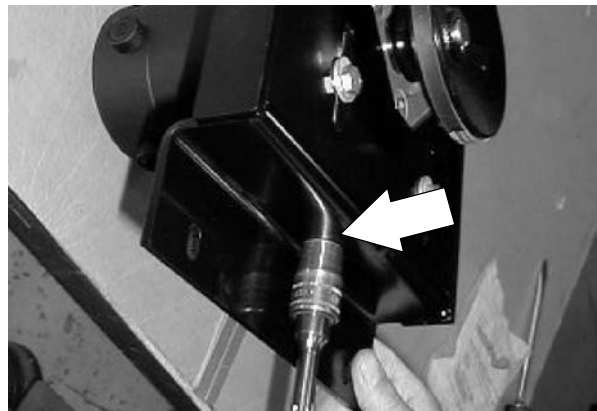

7. Remove the V-belt from the vacuum fan sheave.

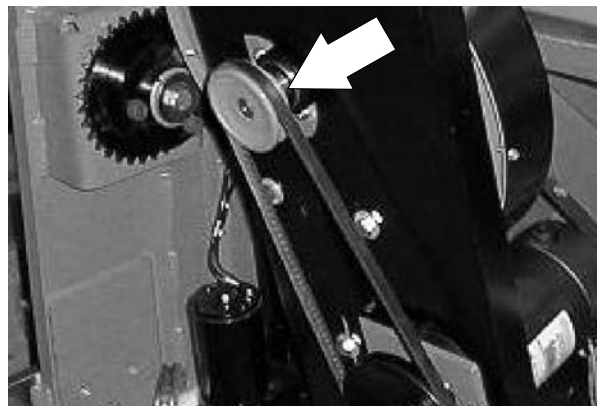

SWEEPING

8. Remove the four hex screws holding the vacuum fan housing to the mount plate.

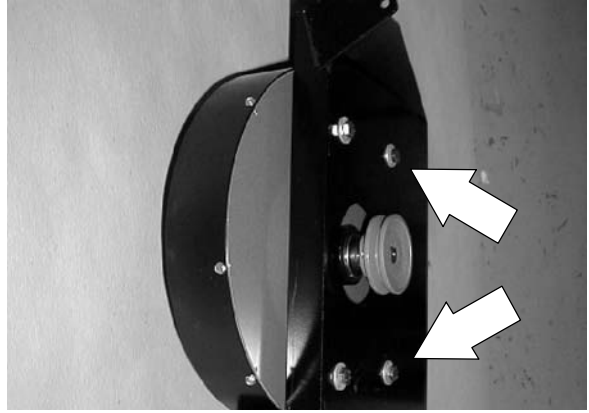

9. Remove the vacuum housing out the front of the machine.

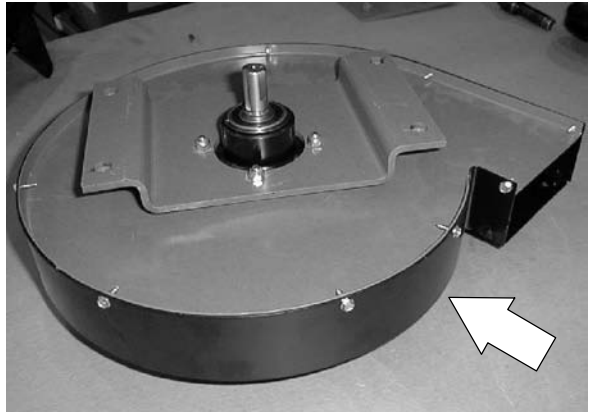

TO INSTALL VACUUM FAN ASSEMBLY

FOR SAFETY: Before Leaving Or Servicing Machine; Stop On Level Surface, Set Parking Brake.

1. Position the vacuum fan housing assembly into the front of the sweeper frame opening.

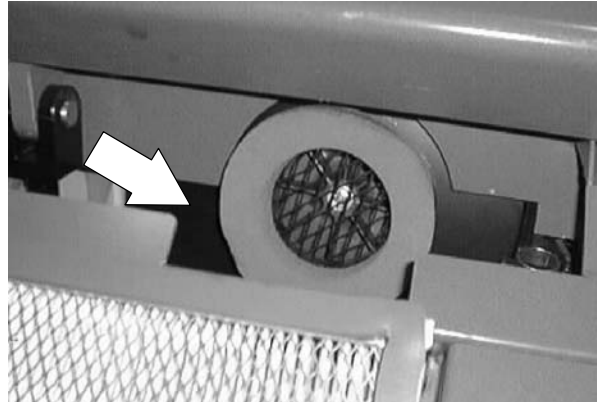

2. Reinstall the four hex screws holding the vacuum fan assembly to the mount frame. Tighten to 18 - 24 Nm (15 - 20 ft lb).

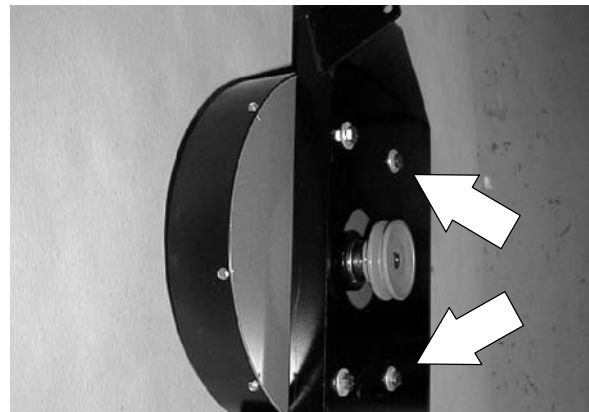

3. Use a straight edge to line up the sheave on the vacuum fan motor with the sheave on the vacuum fan impeller shaft. *Loosen the set screws on the vacuum fan sheave and move it in or out to achieve good alignment. Retighten the set screws tight.*

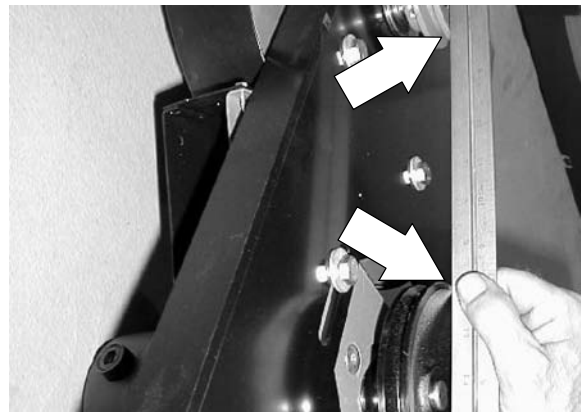

SWEEPING

4. Position the vacuum fan V-belt over the both sheaves.

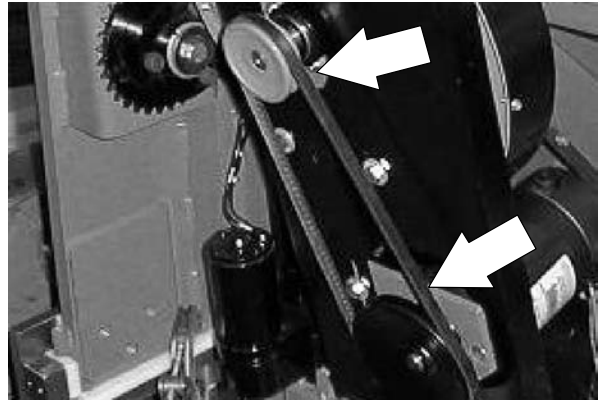

5. Use the hex bolt at the bottom of the mount plate to adjust belt tension.

NOTE: The deflection should be 3 to 7mm (0.125 to 0.25 in) when a force of 2.3 kg (5 lb) is applied at the belt midpoint.

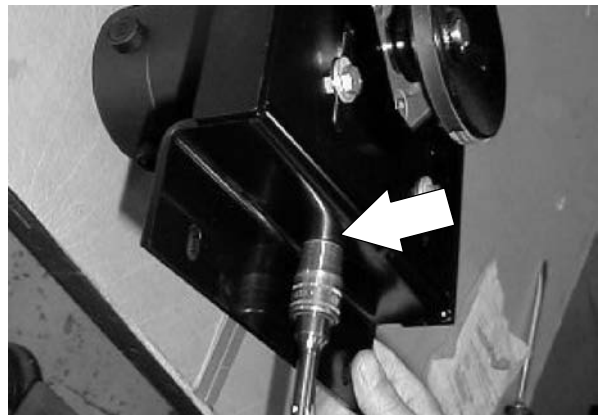

6. Tighten the three motor mount screws to 18 - 24 Nm (15 - 20 ft lb).

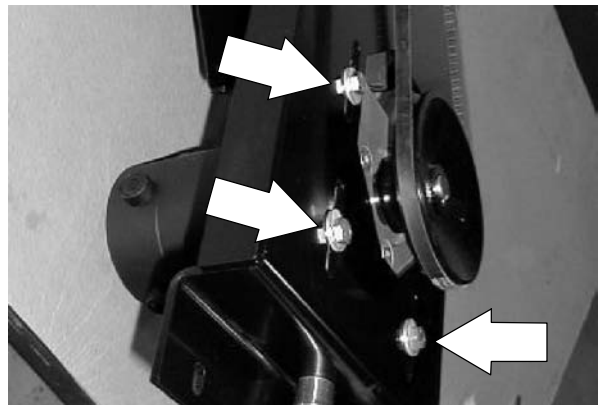

7. Reconnect the battery connector to the machine connector.

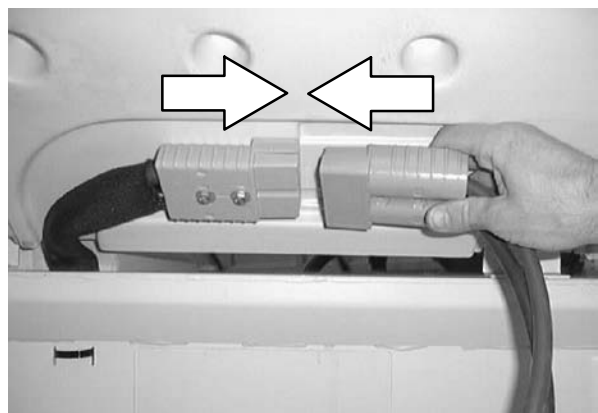

8. Close the rear battery cover.



9. Reinstall the access panel, debris filter, and hopper cover.



10. Close the top cover and side door. Lower the hopper.



11. Operate the vacuum fan. Check for proper operation.

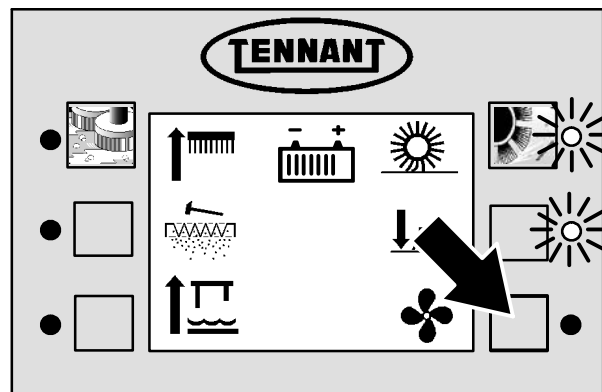

SWEEPING

TO REPLACE VACUUM FAN IMPELLER BEARINGS

FOR SAFETY: Before Leaving Or Servicing Machine; Stop On Level Surface, Set Parking Brake.

1. Remove the vacuum fan housing assembly from the machine. See TO REMOVE VACUUM FAN HOUSING ASSEMBLY instructions in this section.

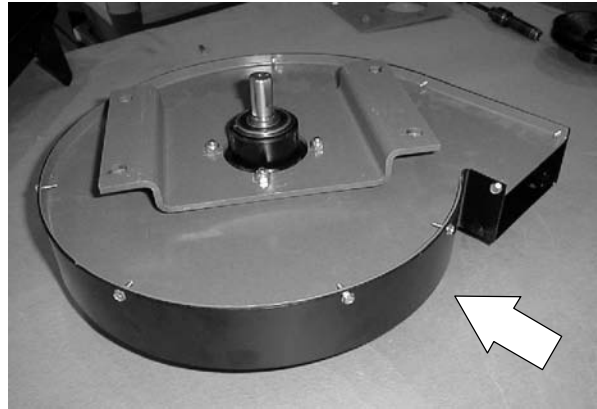

2. Remove the eight small sheet metal screws holding the outer housing to the vacuum fan assembly. Pull the housing off the backing plate.

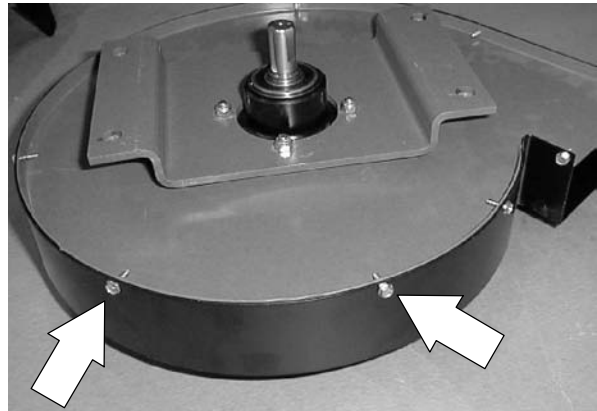

3. Hold the impeller from turning. Remove the hex nut from the center of the vacuum fan shaft.

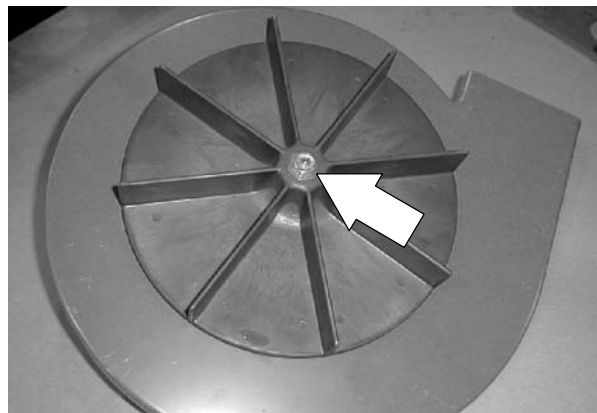

4. Pull the vacuum fan impeller straight off the shaft.

NOTE: Make sure to retain the shaft key and shaft spacer.

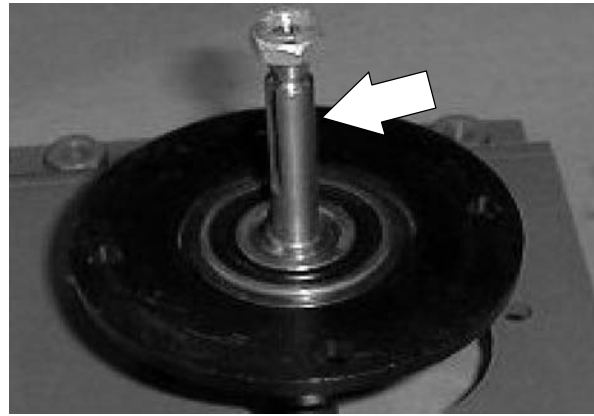

5. Remove the four hex screws and nuts holding the shaft and bearing assembly to the mount bracket and backing plate.

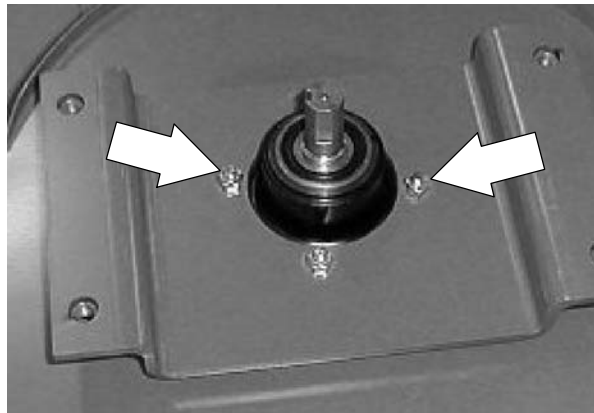

6. Remove the bearing housing from the mount bracket and backing plate.



7. Use a press to remove the impeller shaft and inner bearing from the bearing housing. Press the bearing and shaft in the direction of the fan sheave.

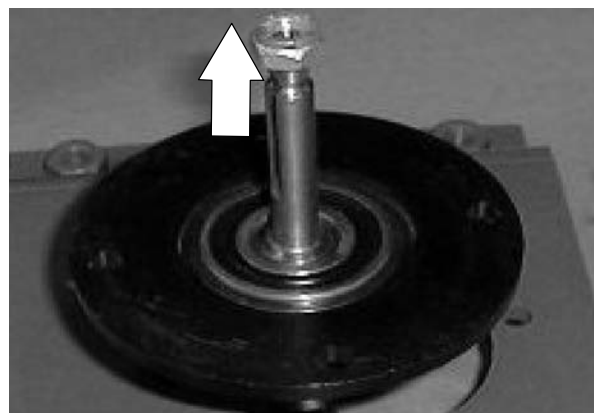

SWEEPING

8. Press the second bearing out of the housing.

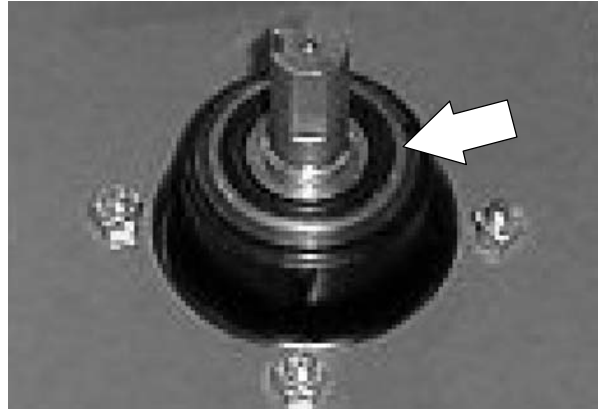

9. Press a new bearing into the housing on the sheave side. Press the bearing in until the snap ring contacts the housing.

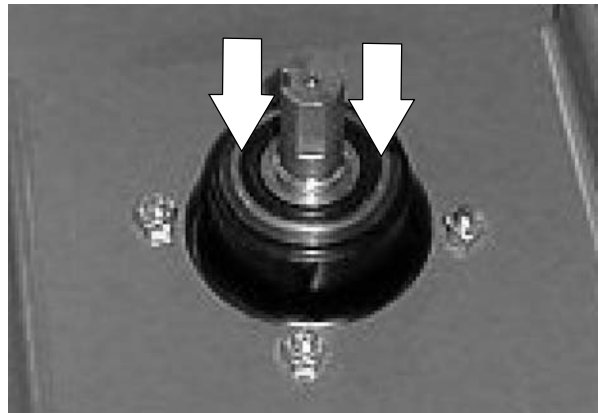

10. Press the impeller shaft into the new bearing.

NOTE: The impeller side of the shaft must be on the flange side of the bearing housing.

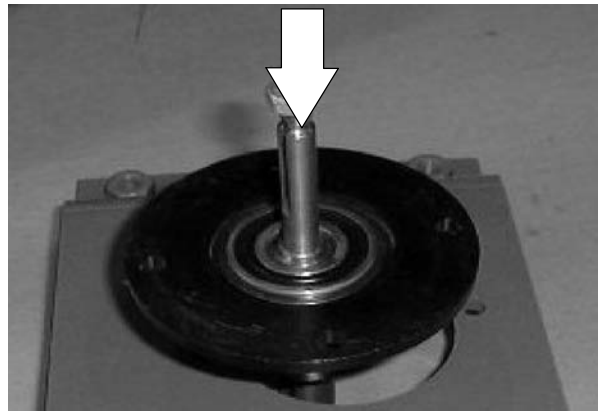

11. Press the second bearing into the housing over the impeller shaft. Press the bearing in until the snap ring contacts the housing.

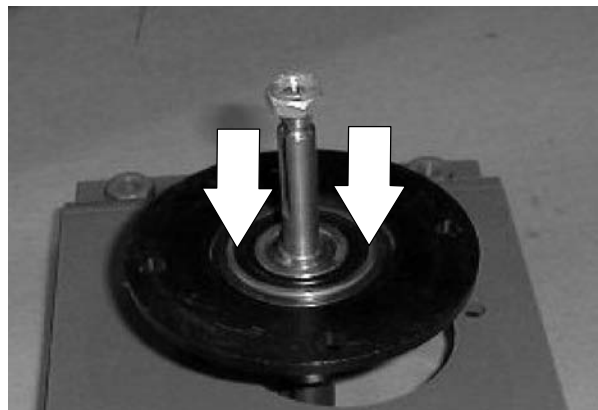

12. Reinstall the bearing assembly and backing plate onto the mount bracket. Reinstall the hardware and tighten to 7.6 - 9.9 Nm (6 - 8 ft lb).

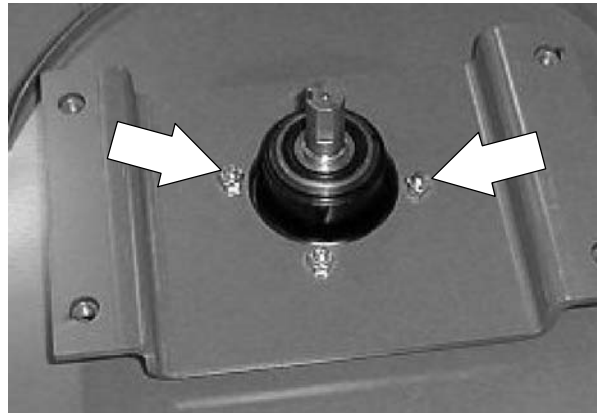

13. Reinstall the sheave on the larger diameter end of the impeller shaft. Make sure the pulley is positioned in the same location as it was removed. Hand tighten the set screws.

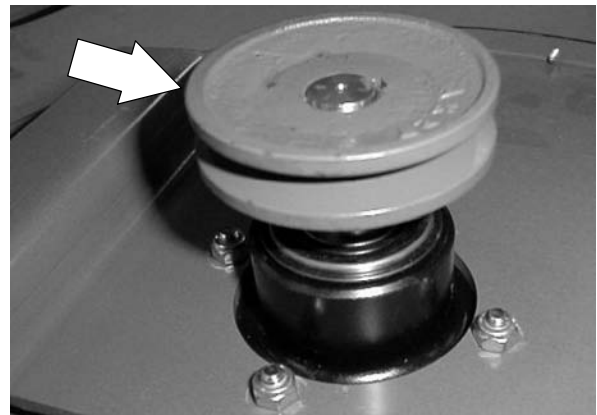

14. Reinstall the impeller on the impeller shaft. Make sure the key and spacer are in place on the shaft.

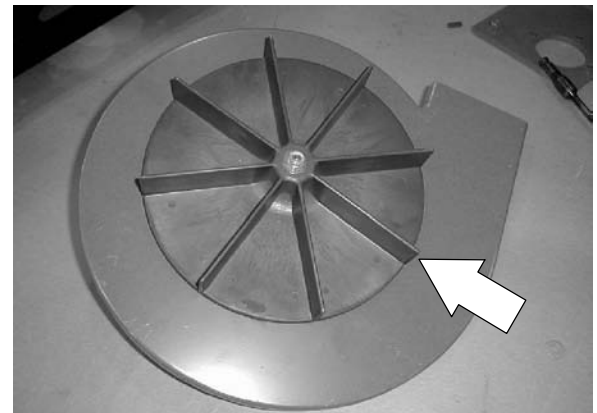

15. Hold the impeller from turning. Install the hex nut on the impeller shaft. Tighten to 18 - 24Nm (15 - 20 ft lb).

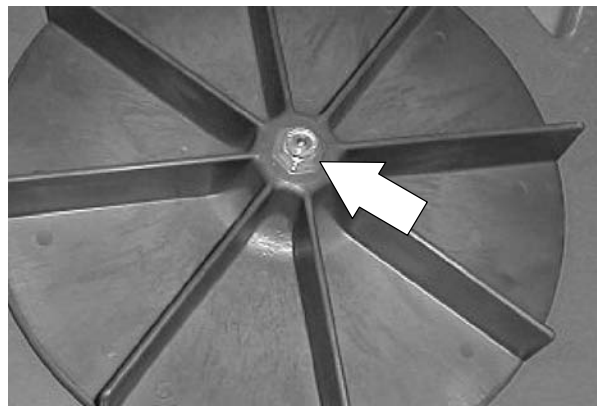

SWEEPING

16. Reinstall the vacuum fan housing on the backing plate. Hand tighten the smaller hex screws.

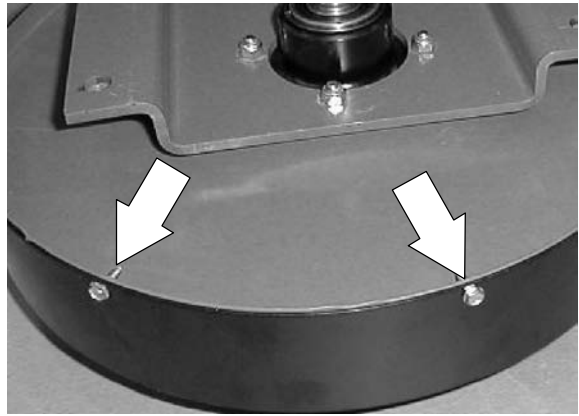

17. Reinstall the vacuum fan housing assembly into the machine. See TO INSTALL VACUUM FAN HOUSING ASSEMBLY instructions in this section.



18. Reconnect the battery connector to the machine connector.

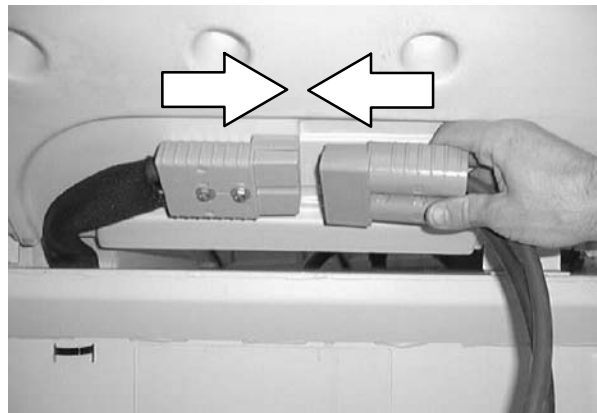

19. Operate the vacuum fan. Check for proper operation.

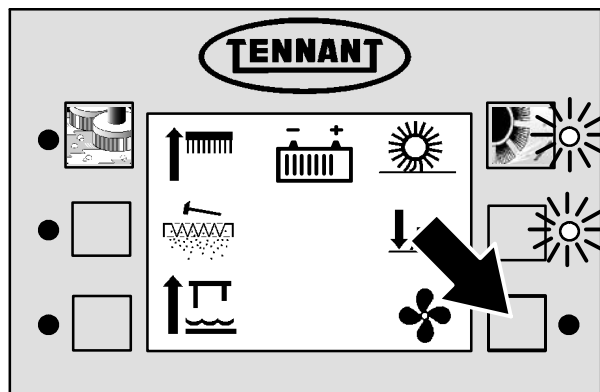

TO TENSION VACUUM FAN BELT

FOR SAFETY: Before Leaving Or Servicing Machine; Stop On Level Surface, Set Parking Brake.

1. Open the cover and side door.



2. Locate the vacuum fan V-belt in front of the main electrical panel.

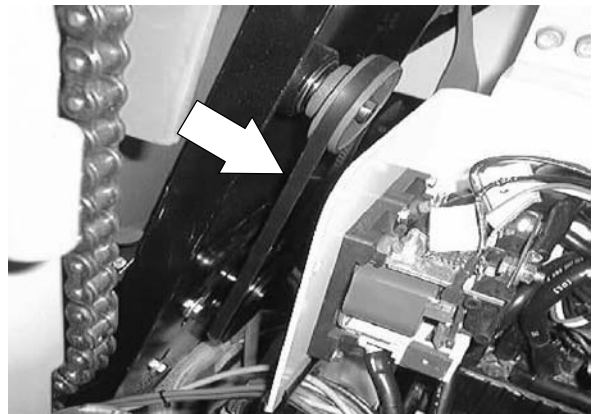

3. Loosen the three hex screws holding the vacuum fan electric motor to the mount bracket.

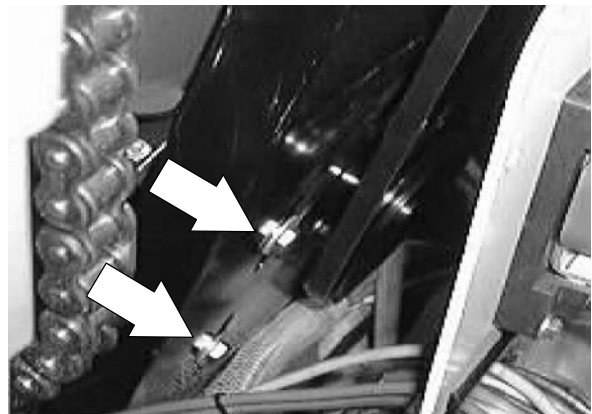

SWEEPING

4. Use the tensioning bolt on the bottom side of the vacuum fan mount bracket to move the motor down in the slots to tighten the V-belt. *Tighten the bolt until the V-belt is tensioned properly. The deflection should be 3 to 7mm (0.125 to 0.25 in) when a force of 2.3 kg (5 lb) is applied at the belt midpoint.*

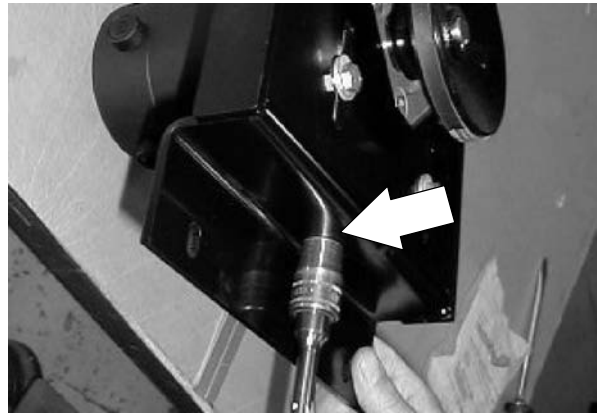

5. Tighten the three electric motor mount screws to 18 - 24 Nm (15 - 20 ft lb).

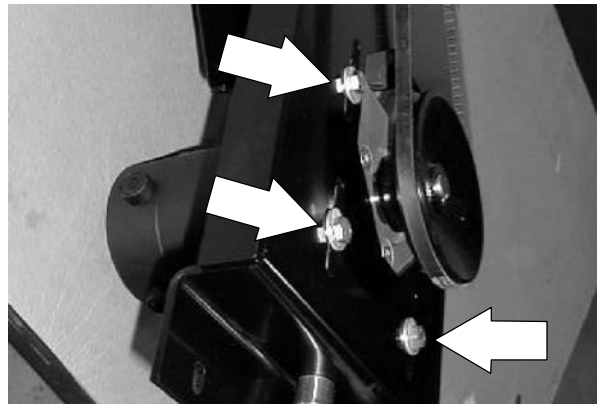

6. Operate the vacuum fan. Check for proper operation.

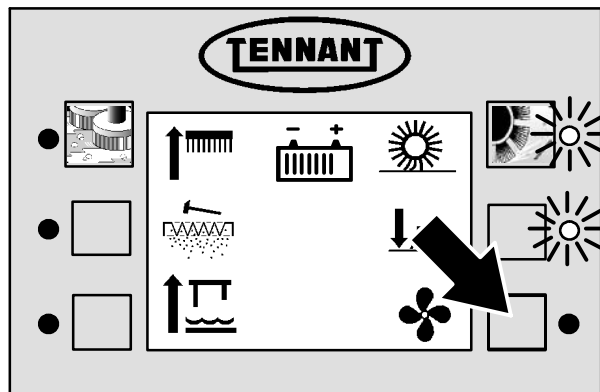

7. Close the cover and side door.



MACHINE SWEEPING TROUBLESHOOTING

★ *NOTE; Also see trouble shooting charts in the ELECTRICAL section.*

Problem	Cause	Remedy
Poor sweeping performance	Main brush worn out	Replace main brush
	Main brush not properly adjusted	Adjust main brush to obtain correct brush pattern
	Main brush not level with floor	Adjust brush pattern
	Hopper full	Empty hopper
	Dust filter clogged	Remove and clean dust filter
	Brush jammed with debris	Remove debris
	Hopper lip or dust skirt not properly adjusted	Adjust hopper lip or dust skirt
Dusting	Dust filter clogged	Remove and clean filter
	Filter not seated correctly against its seals	Remove and reinstall filter
	Dust filter damaged	Replace dust filter
	Hopper full	Empty hopper
	Clogged ducts	Clean ducts
	Ducts not engaging seals or seals damaged	Adjust or replace seals
	Dust skirts not properly adjusted or are damaged	Adjust or replace dust skirts
	Vacuum fan not operating	Check fan circuit breaker
Brush pattern not even	Main brush not lowering evenly due to debris jam	Remove main brush and debris
	Idler arm not level	Adjust arm position
	Main brush idler arm may be out of adjustment	Adjust arm position
	Main brush not seated correctly on drive cups	Remove and reinstall main brush

CONTENTS

	Page		Page
INTRODUCTION	4-3	SQUEEGEES	4-64
SOLUTION TANK	4-4	SIDE SQUEEGEES	4-64
TO REMOVE SOLUTION TANK	4-4	TO REPLACE SIDE SQUEEGEES ..	4-64
TO INSTALL SOLUTION TANK	4-7	TO ADJUST SIDE SQUEEGEES ...	4-66
RECOVERY TANK	4-10	SIDE SQUEEGEE DOUBLE SCRUB	
TO REMOVE RECOVERY TANK	4-10	CLIPS	4-66
TO INSTALL RECOVERY TANK	4-14	TO ENGAGE DOUBLE SCRUB	
SCRUB HEAD	4-18	CLIPS	4-66
TO REMOVE TWO MOTOR DISC		REAR SQUEEGEE	4-67
SCRUB HEAD (MAXPRO™ 1000)	4-18	TO REPLACE OR ROTATE REAR	
TO INSTALL TWO MOTOR DISC		SQUEEGEE BLADES	4-67
SCRUB HEAD (MAXPRO™ 1000)	4-22	TO ADJUST REAR SQUEEGEE	
TO REMOVE THREE MOTOR DISC		DEFLECTION	4-70
SCRUB HEAD (MAXPRO™ 1200)	4-26	TO LEVEL REAR SQUEEGEE	4-71
TO INSTALL THREE MOTOR DISC		TO REPLACE REAR SQUEEGEE LIFT	
SCRUB HEAD (MAXPRO™ 1200)	4-30	CABLE	4-72
TO REMOVE CYLINDRICAL SCRUB		TO REMOVE REAR SQUEEGEE	
HEAD (MAXPRO™ 1000 AND 1200)	4-34	ASSEMBLY	4-74
TO INSTALL CYLINDRICAL SCRUB		TO INSTALL REAR SQUEEGEE	
HEAD (MAXPRO™ 1000 AND 1200)	4-38	ASSEMBLY	4-76
TO REPLACE CYLINDRICAL SCRUB		VACUUM FANS	4-77
HEAD DRIVE PLUG SHAFT		TO REMOVE VACUUM FAN	
BEARINGS	4-42	ASSEMBLY	4-77
TO REPLACE CYLINDRICAL SCRUB		TO INSTALL VACUUM FAN	
HEAD IDLER PLUG SHAFT		ASSEMBLY	4-79
BEARING	4-47	TO REPLACE INDIVIDUAL VACUUM	
DISC SCRUB HEAD SKIRTS	4-50	FAN	4-81
TO REPLACE DISC SCRUB HEAD		MACHINE TROUBLESHOOTING	4-84
SKIRTS	4-50		
TO ADJUST DISC SCRUB HEAD			
SKIRTS	4-50		
SCRUB BRUSHES	4-51		
DISC SCRUB BRUSHES	4-51		
TO REPLACE DISC SCRUB BRUSH	4-52		
CYLINDRICAL SCRUB BRUSHES	4-54		
TO REPLACE CYLINDRICAL SCRUB			
BRUSH	4-54		
CHECKING AND ADJUSTING			
CYLINDRICAL BRUSH PATTERN	4-57		
MANUAL SOLUTION VALVE	4-60		
TO REPLACE MANUAL SOLUTION			
VALVE	4-60		
TO ADJUST MANUAL SOLUTION			
VALVE	4-63		

INTRODUCTION

In the scrubbing mode the water flows from the solution tank, through the solution valve, and down to the scrub brushes. The brushes scrub the floor. As the machine moves forward the rear squeegee wipes the dirty solution off the floor, which is then picked up and drawn into the recovery tank by the vacuum fans.

SCRUBBING

SOLUTION TANK

The solution tank is located on the right side of the machine. Water from the solution tank flows from the bottom of the tank to the water valve located on the scrub head. Filtered water from the recovery tank is pumped to the top of the solution tank when the ES™ option is in use.

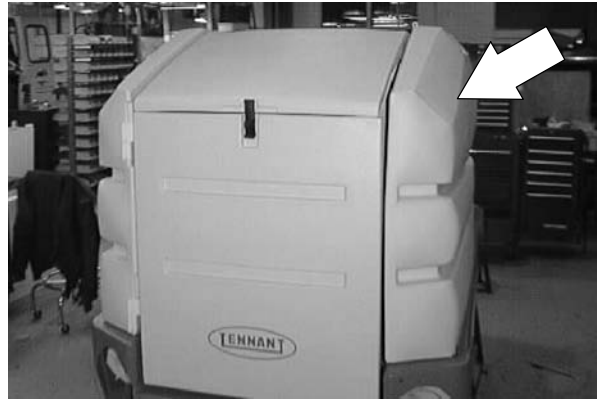

TO REMOVE SOLUTION TANK

FOR SAFETY: Before Leaving Or Servicing Machine; Stop On Level Surface, Set Parking Brake.

1. Make sure the solution tank (right side of machine) has been drained.

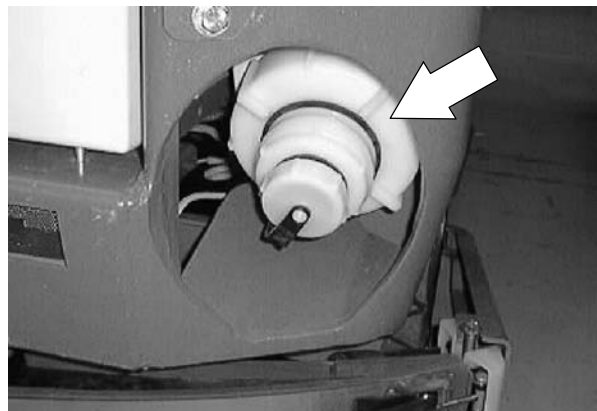

2. Raise the battery cover. Unplug the battery connector.

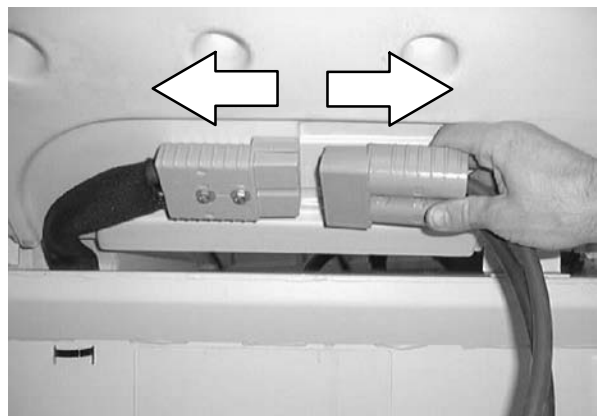

3. Disconnect the float switch from the main harness.

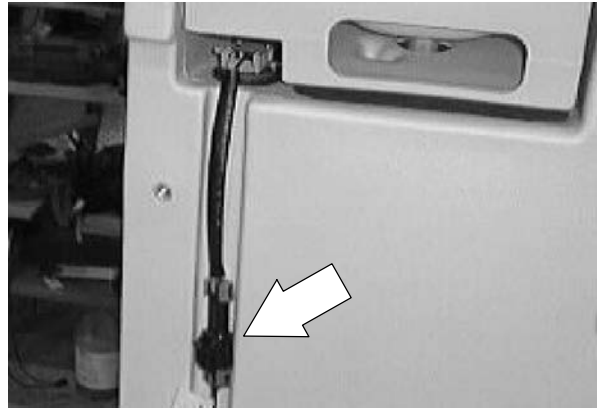

4. Disconnect the ES™ water line from the top of the solution tank.

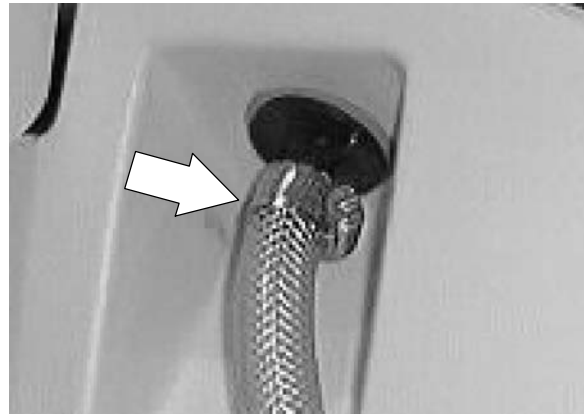

5. Remove the six hex screws holding the operator seat mount plate to the solution tank. Remove the seat assembly.



6. Go under the solution tank. Disconnect the main drain line from the bottom of the solution tank.

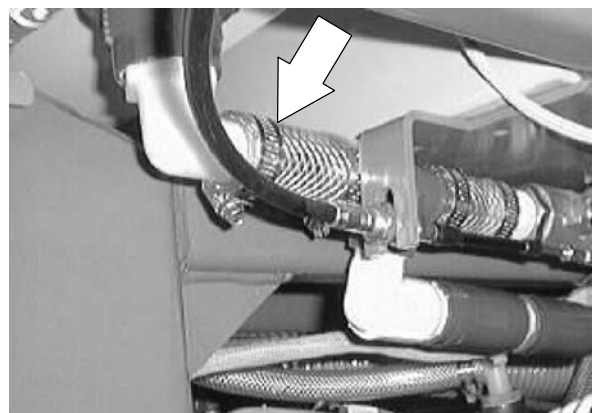

SCRUBBING

7. Go under the solution tank in the area under the rear of the operator floor plate. Remove the two hex screws holding the front of solution tank to the frame bracket.

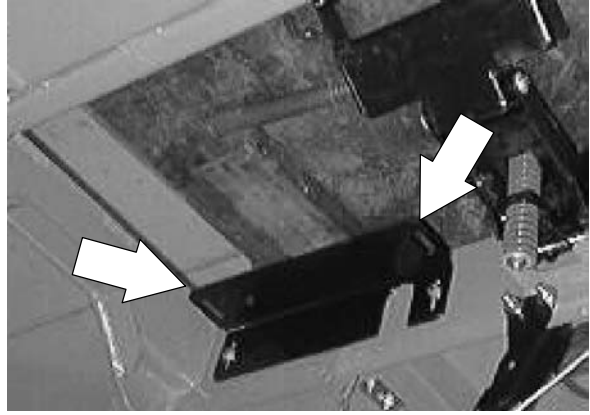

8. Remove the two hex screws holding battery cover mount plate to the inside of the solution tank.

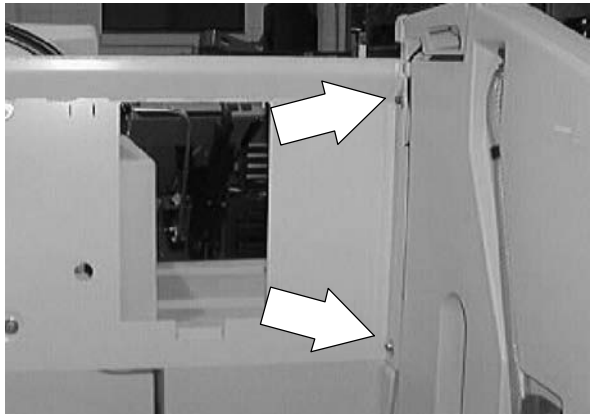

9. Remove the two hex screws holding the solution tank to the vertical mount channel at the right side of the battery.

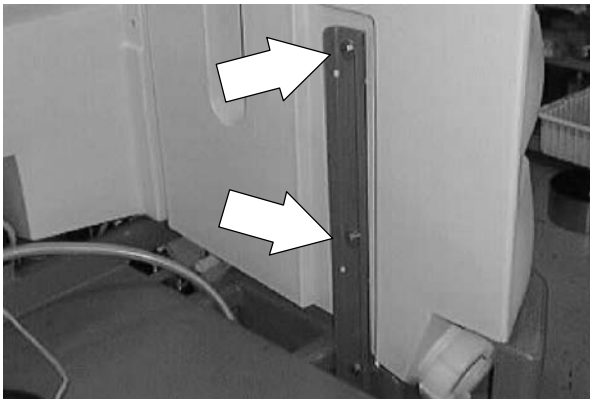

10. The solution tank can now be carefully be lifted out of the machine frame.

NOTE: Remove the solution level switch assembly from the mount hole in the tank. Use this hole to attach a lifting strap. The tank will lift fairly level using this procedure.



TO INSTALL SOLUTION TANK

FOR SAFETY: Before Leaving Or Servicing Machine; Stop On Level Surface, Set Parking Brake.

1. Carefully position the solution tank into the machine frame.

NOTE: Remove the solution level switch assembly from the mount hole in the tank. Use this hole to attach a lifting strap. The tank will lift fairly level using this procedure.



2. Loosely install the two hex screws holding the solution tank to the vertical mount channel at the right side of the battery.

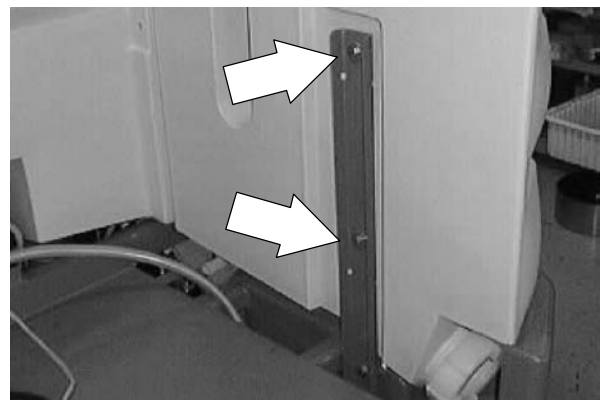

3. Loosely install the two hex screws holding battery cover mount plate to the inside of the solution tank.

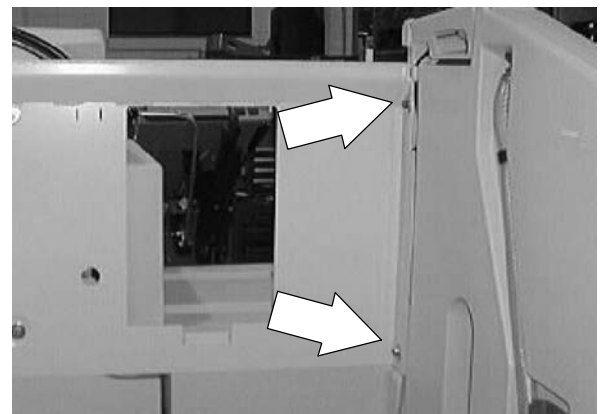

SCRUBBING

4. Go under the solution tank in the area under the rear of the operator floor plate. Loosely install the two hex screws holding the front of solution tank to the frame bracket. Go back and tighten all six mounting screws to 18 - 24 Nm (15 - 20 ft lb).

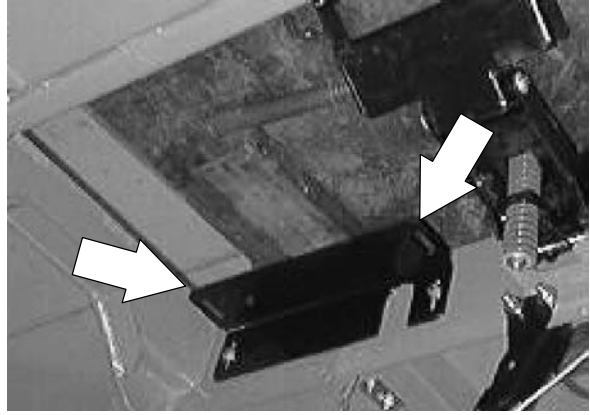

5. Reinstall the seat assembly. Reinstall the six hex screws holding the operator seat mount plate to the solution tank. Tighten screws to 18 - 24 Nm (15 - 20 ft lb).



6. Reconnect the main solution line to the bottom of the tank.

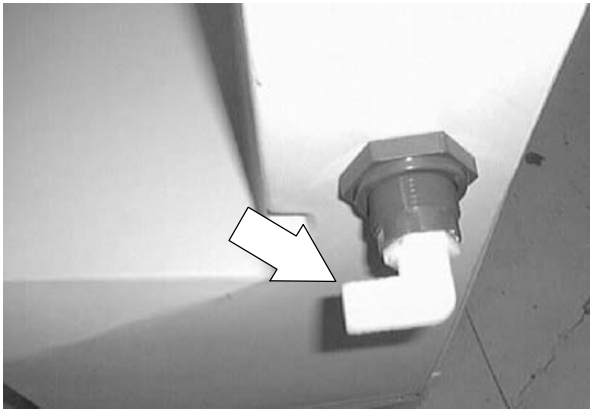

7. Reconnect the ES™ water line to the top of the solution tank.

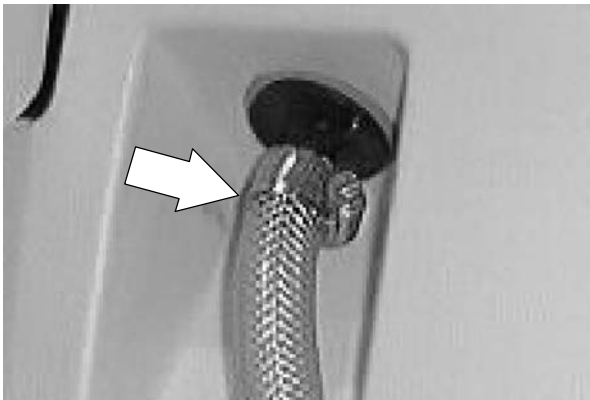

8. Reconnect the float switch to the main harness.

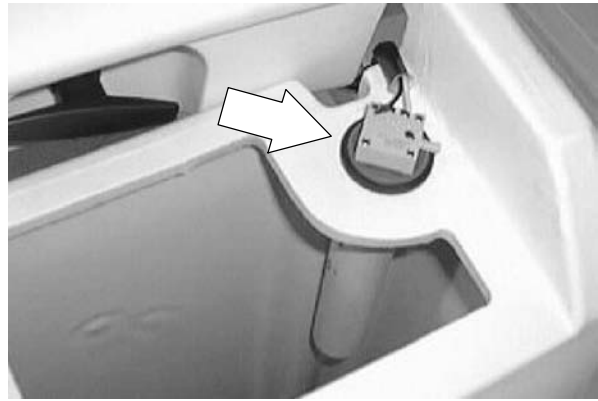

9. Plug the battery connector into the main connector.

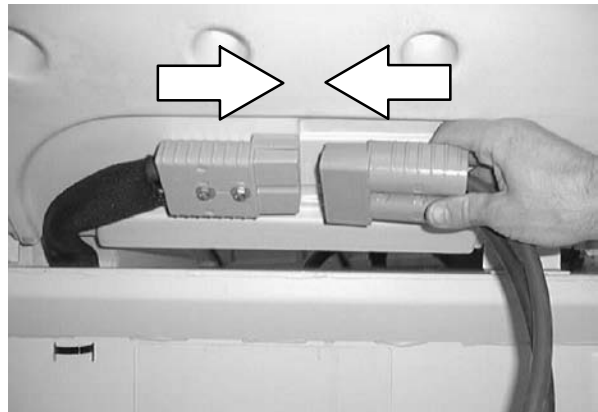

10. Close the battery cover.



SCRUBBING

RECOVERY TANK

The recovery tank is located on the left side of the machine. The scrubber vacuum fans located on the front of the recovery tank pull dirty water from the rear squeegee and deposit it into the recovery tank.



TO REMOVE RECOVERY TANK

FOR SAFETY: Before Leaving Or Servicing Machine; Stop On Level Surface, Set Parking Brake.

1. Make sure the recovery tank (left side of machine) has been drained.

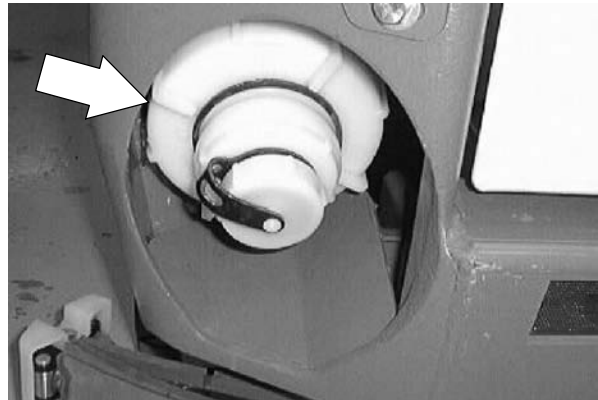

2. Raise the battery cover. Unplug the battery connector.

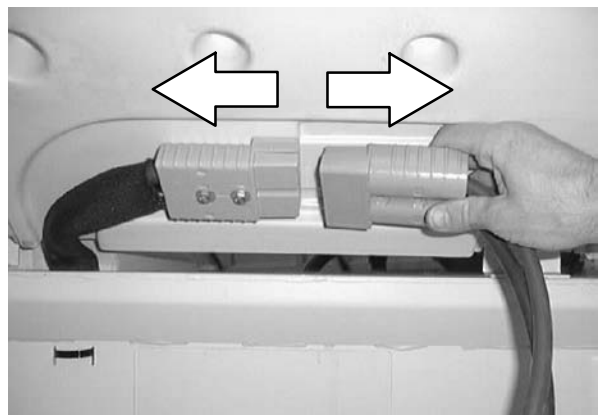

3. Disconnect the float switch from the main harness.

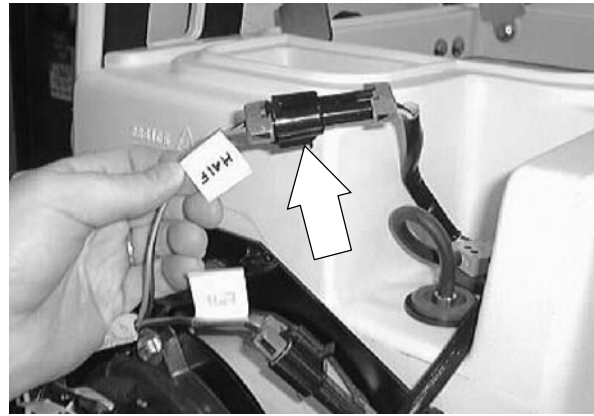

4. Disconnect the air valve from the main harness.

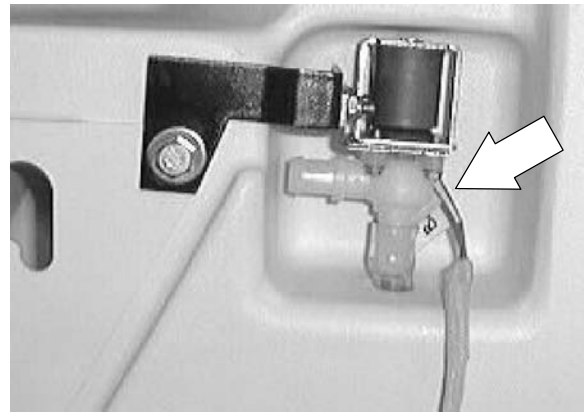

5. Remove the bracket holding the rear squeegee vacuum hose to the side of the recovery tank. Remove the vacuum hose from the recovery tank.

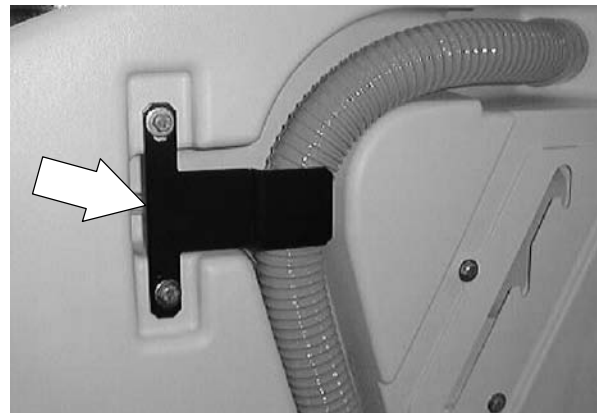

6. Disconnect the scrubbing vacuum fans and vacuum switch from the main harness.

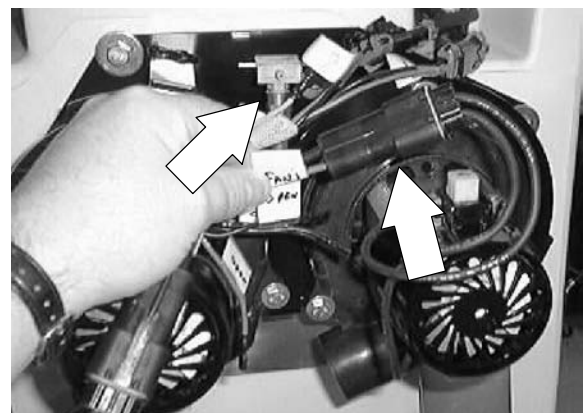

SCRUBBING

7. Remove the two hex screws holding the side of the operator seat mount plate to the side of the recovery tank.



8. Go under the recovery tank. Disconnect the ES™ water line and autofill line from the bottom of the recovery tank.

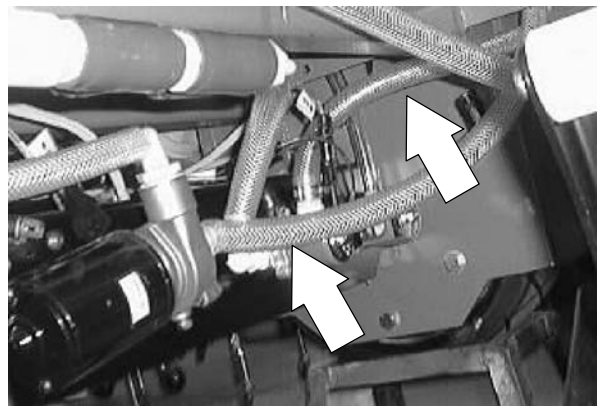

9. Go under the recovery tank in the area under the scrubbing vacuum fans. Remove the two hex screws holding the front of recovery tank to the frame bracket.

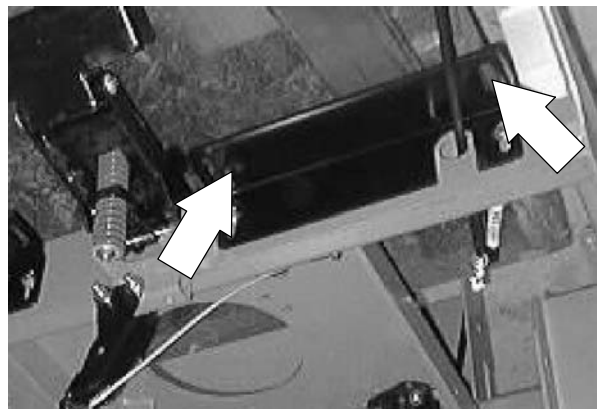

10. Remove the two hex screws holding battery cover mount plate to the inside of the recovery tank.

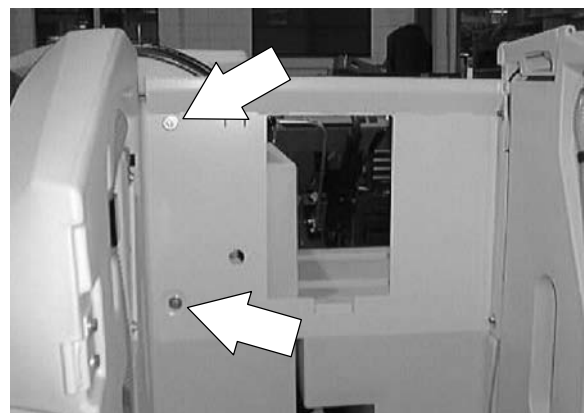

11. Remove the two hex screws holding the recovery tank to the vertical mount channel at the left side of the battery.

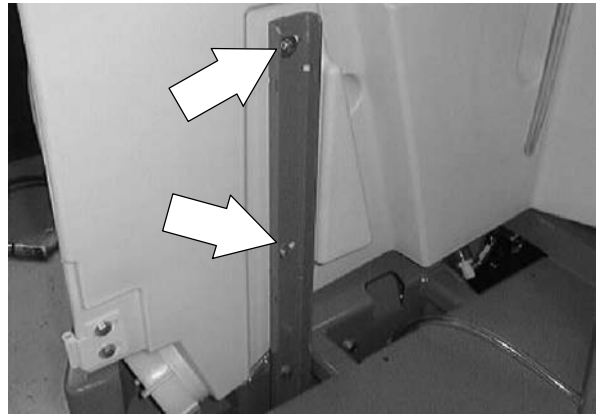

12. Remove the clamp holding the battery cables to the back of the recovery tank.

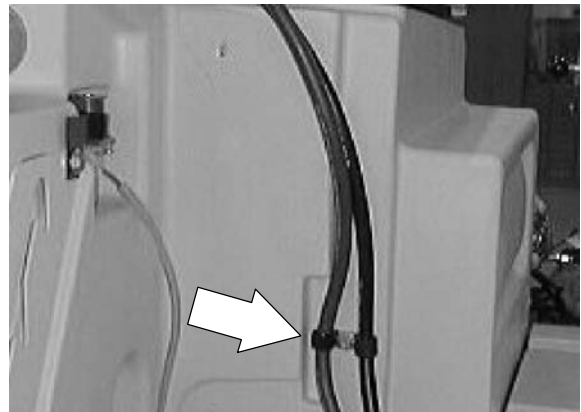

13. The recovery tank can now be carefully be lifted out of the machine frame.

NOTE: Remove the solution level switch assembly from the mount hole in the tank. Use this hole to attach a lifting strap. The tank will lift fairly level using this procedure.



SCRUBBING

TO INSTALL RECOVERY TANK

FOR SAFETY: Before Leaving Or Servicing Machine; Stop On Level Surface, Set Parking Brake.

1. Carefully position the recovery tank into the machine frame.

NOTE: Remove the solution level switch assembly from the mount hole in the tank. Use this hole to attach a lifting strap. The tank will lift fairly level using this procedure.

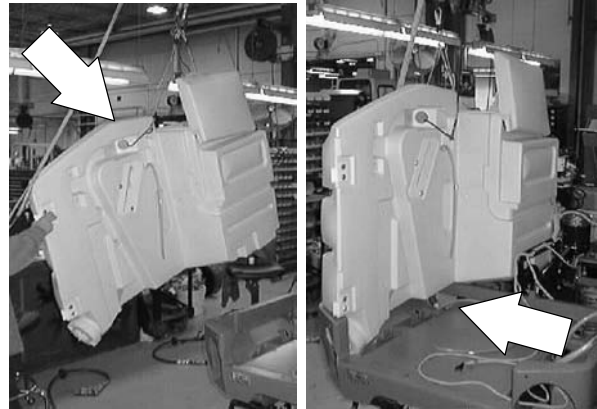

2. Loosely install the two hex screws holding the recovery tank to the vertical mount channel at the right side of the battery.

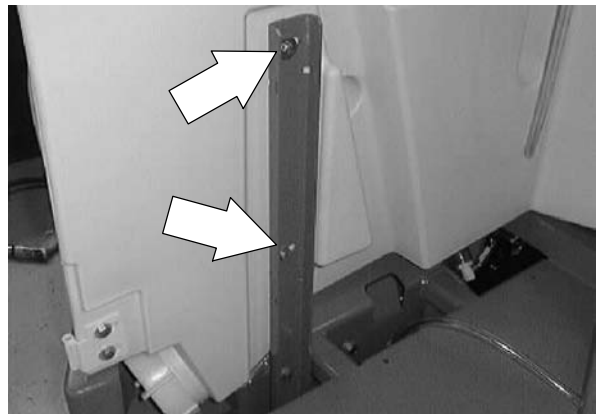

3. Loosely install the two hex screws holding battery cover mount plate to the inside of the recovery tank.

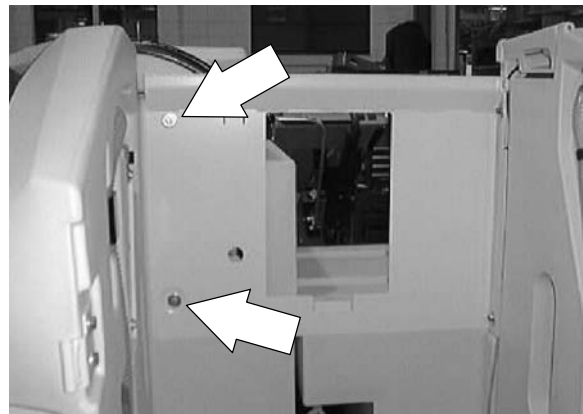

- Go under the recovery tank in the area under the scrubbing vacuum fans. Loosely install the two hex screws holding the front of recovery tank to the frame bracket. Go back and tighten all six mounting screws to 18 - 24 Nm (15 - 20 ft lb).

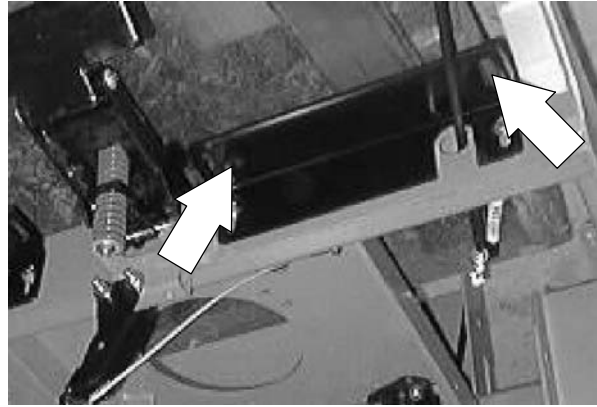

- Reconnect the ES™ water line and autofill solution line to the bottom of the tank.

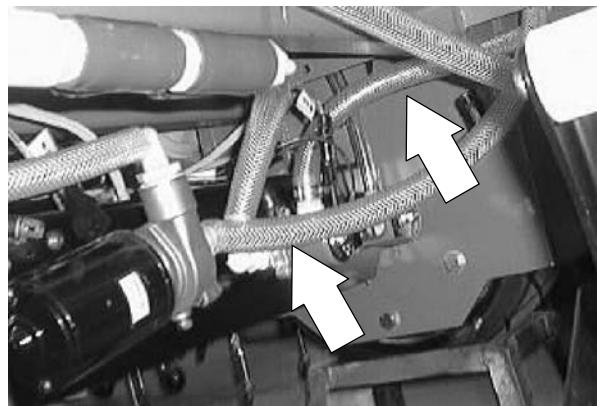

- Reconnect the air valve to the main harness.

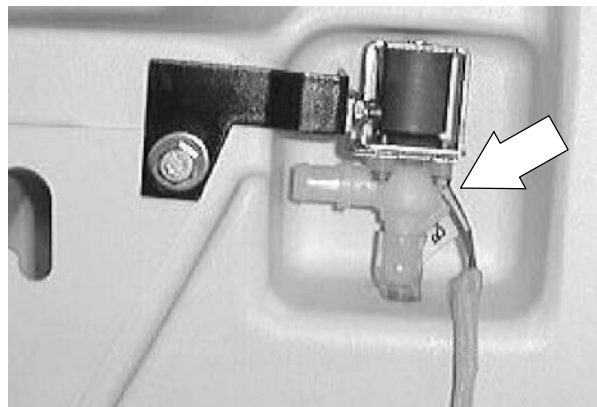

- Reinstall the vacuum hose into the vacuum hole in the recovery tank. Reinstall the bracket holding the rear squeegee vacuum hose to the side of the recovery tank.

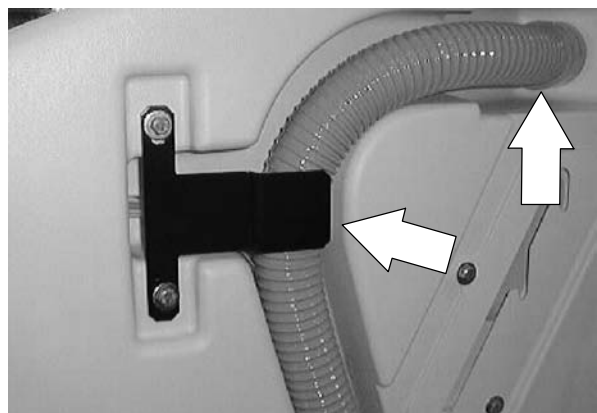

SCRUBBING

8. Reinstall the two hex screws holding the side of the operator seat mount plate to the side of the recovery tank. Tighten to 18 - 24 Nm (15 - 20 ft lb).



9. Reconnect the scrubbing vacuum fans and vacuum switch to the main harness.

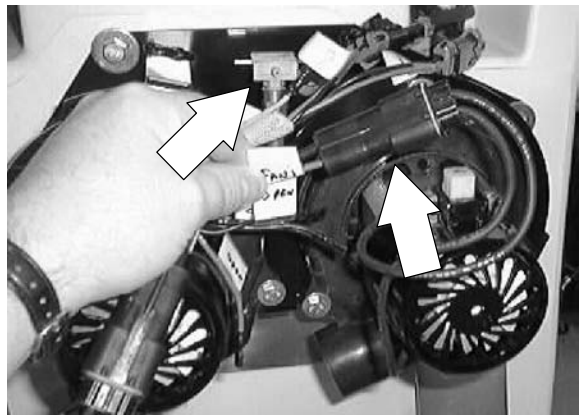

10. Reconnect the float switch to the main harness.

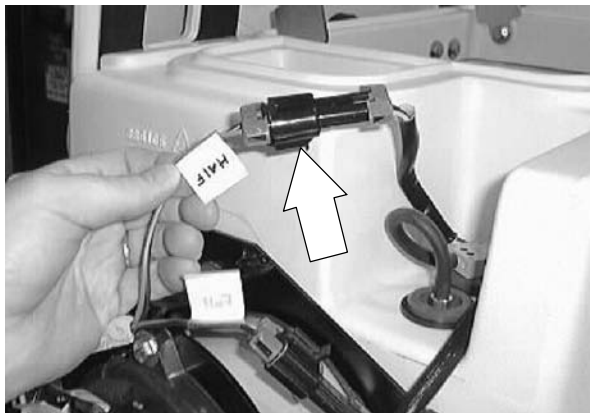

11. Reinstall the clamp holding the battery cables to the back of the recovery tank.

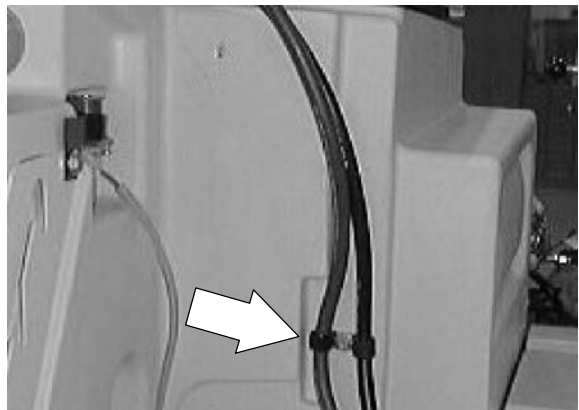

12. Plug the battery connector into the main connector.

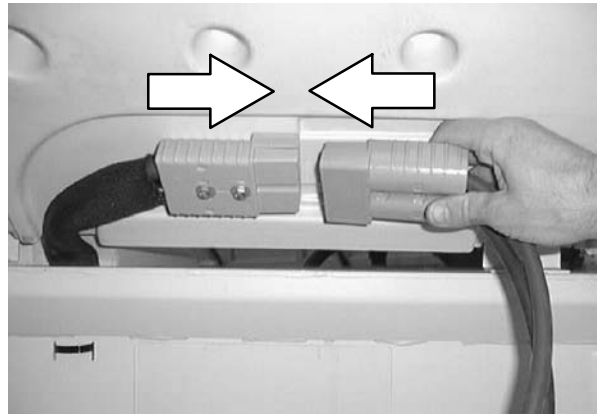

13. Close the battery cover.

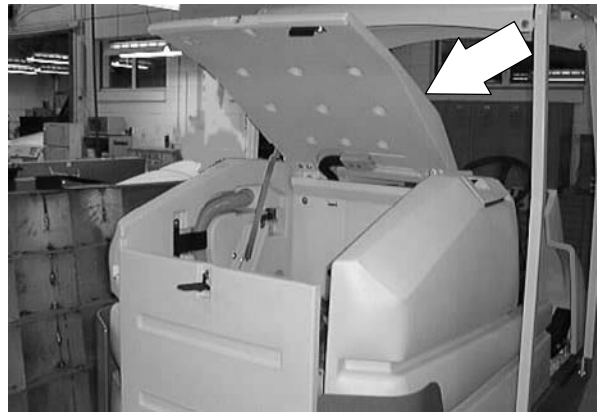

SCRUBBING

SCRUB HEAD

The 8300 can be equipped with five different scrub heads;
MAXPRO™ 1000, MAXPRO™ 1000 HD motors,
MAXPRO™ 1200 disc scrub heads.
MAXPRO™ 1000 and 1200 cylindrical scrub heads.

TO REMOVE TWO MOTOR DISC SCRUB HEAD (MAXPRO™ 1000)

FOR SAFETY: Before Leaving Or Servicing Machine; Stop On Level Surface, Set Parking Brake.

NOTE: Latch the side squeegees in the double scrub position. Leave the scrub brushes on the scrub head.



1. Turn on the machine and *lower* the scrub head. Shut off the key.

NOTE: Use down pressure setting #3 on cylindrical head and down pressure setting #2 on all disc heads.

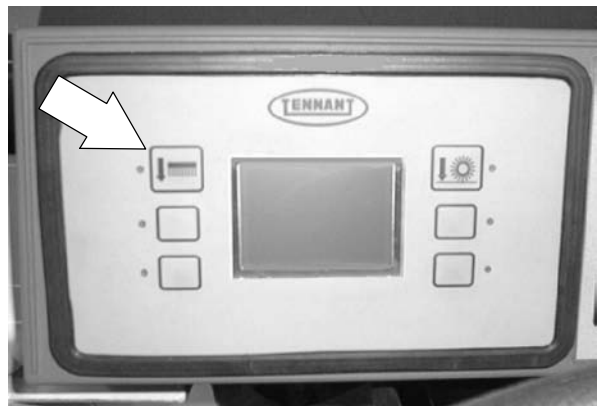

2. Go under the machine in the area of the center of the scrub head. Remove the hex screw holding the **UPPER** head lift roller to the mount bracket. Remove the roller from the scrub head frame.

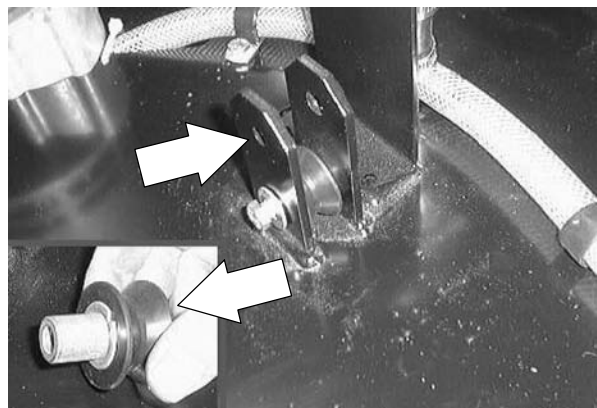

3. Turn on the machine and *raise* the scrub head. Turn off the key.



4. Remove any plastic ties holding the wires and solution lines to the scrub head.

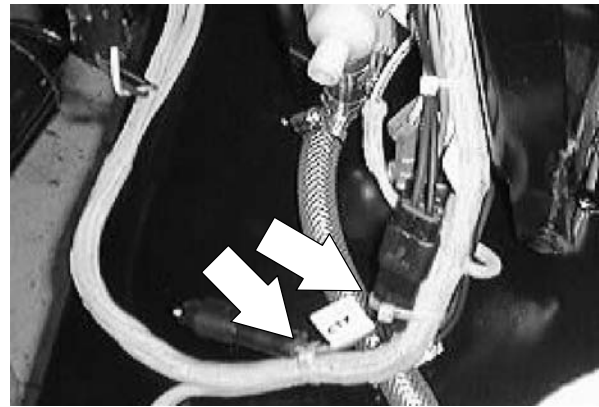

5. Disconnect the two scrub brush motors from the main harness.

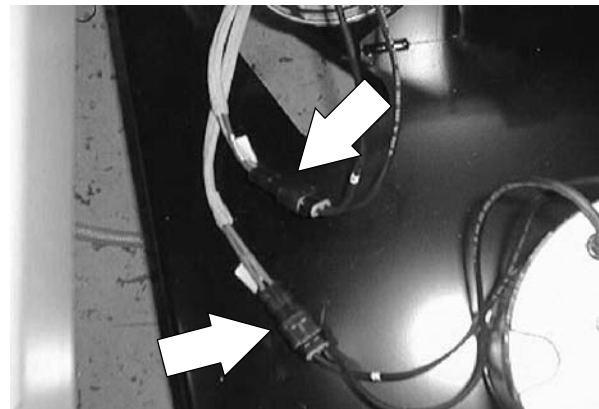

6. Disconnect the water flow solenoid from the main harness.

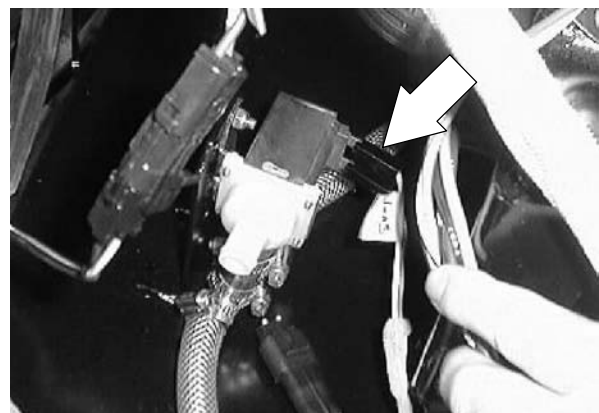

SCRUBBING

7. Disconnect the solution line from the water flow solenoid.

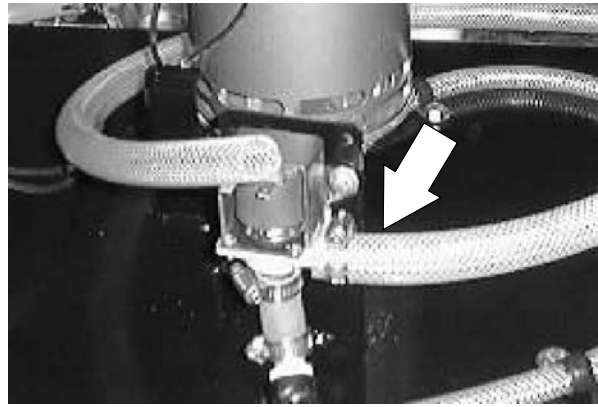

8. Disconnect the end of the side shift gas spring where it attaches to the scrub head.



9. Disconnect the end of the side shift cable where it attaches to the scrub head.

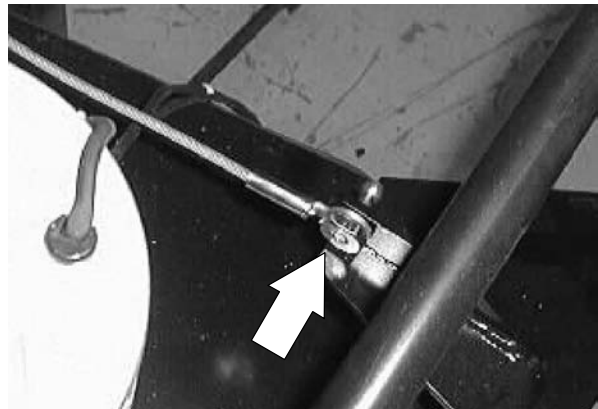

10. Remove the cotter pins and castle nuts from the end of the scrub head drag links where they attach to the machine frame.

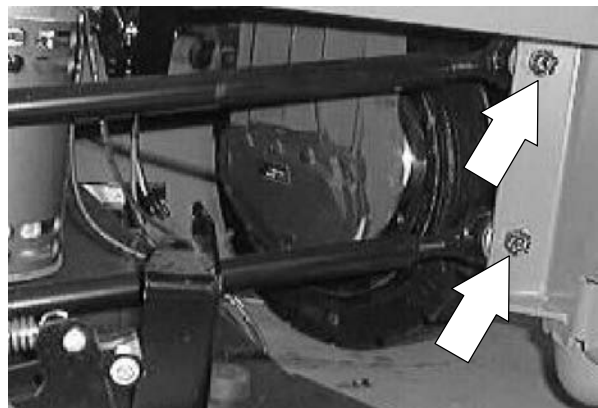

11. Pull the drag links out of the frame mount holes.



12. **If a hoist is available**--raise the front of the machine and place jackstands under the corners of the machine frame.



13. Push or pull the scrub head out the right side (operators compartment side) of the machine. The scrub head can now be removed from the machine.

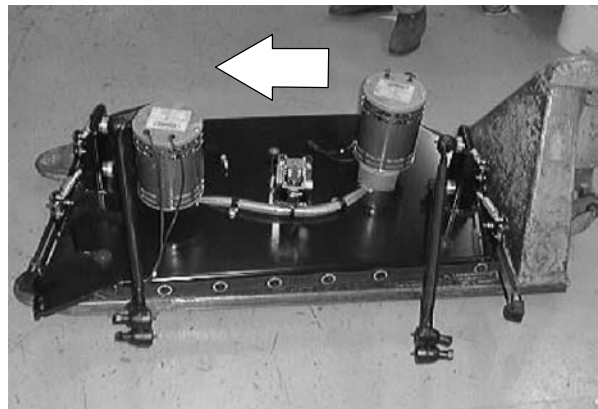

SCRUBBING

TO INSTALL TWO MOTOR DISC SCRUB HEAD (MAXPRO™ 1000)

FOR SAFETY: Before Leaving Or Servicing Machine; Stop On Level Surface, Set Parking Brake.

1. **If a hoist is available--**raise the front of the machine and place jackstands under the corners of the machine frame.

NOTE: Make sure the side squeegees are latched up and the scrub brushes are installed.



2. Push or pull the scrub head into the right side (operator's compartment side) of the machine. Push the head in until it is centered in the frame.

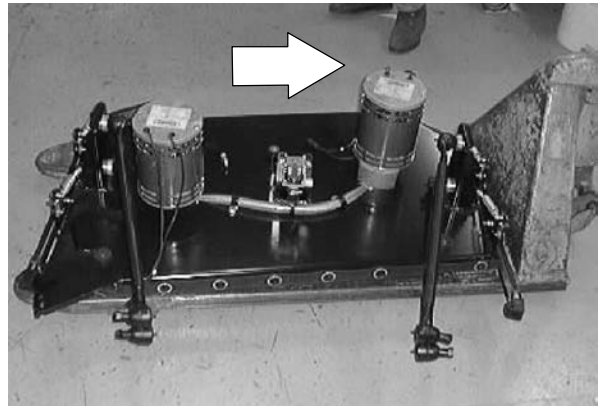

3. Position the four scrub head drag links into the frame mount holes.



4. Reinstall the castle nuts onto the end of the scrub head drag links where they attach to the machine frame. Tighten the castle nuts tight. Reinstall the cotter pins.

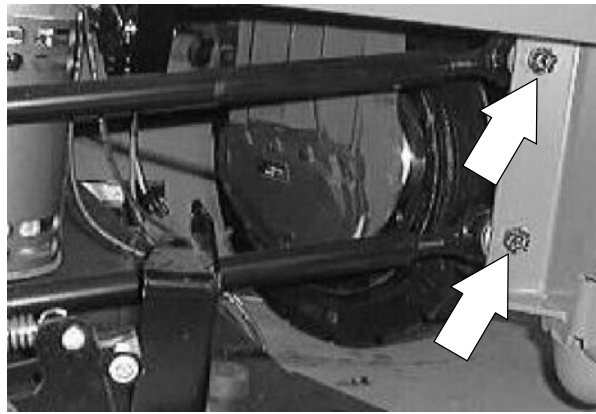

5. Reconnect the two scrub brush motors to the main harness.

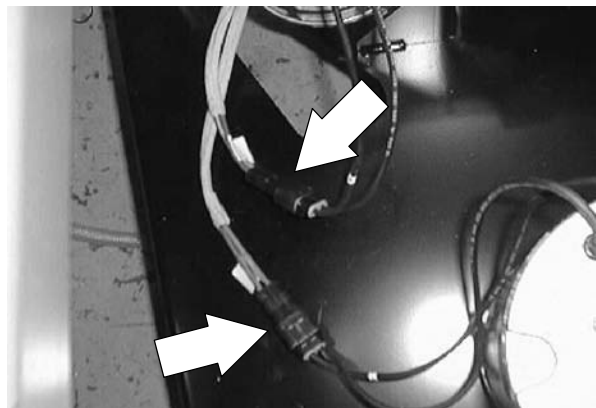

6. Reconnect the water flow solenoid to the main harness.

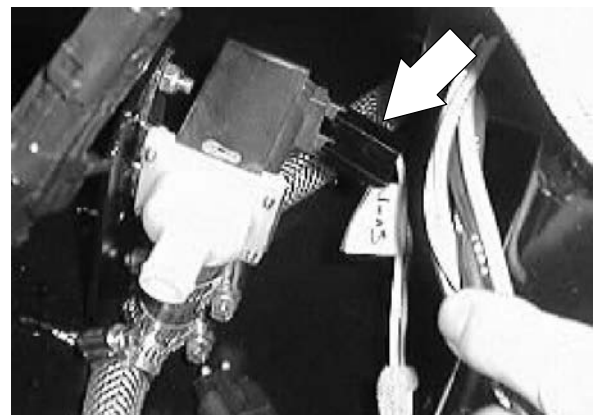

7. Reconnect the solution line to the water flow solenoid.

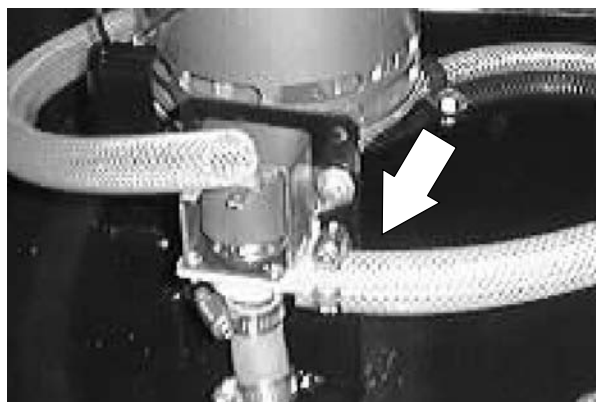

SCRUBBING

8. Use plastic ties to secure electrical wires and solution lines.

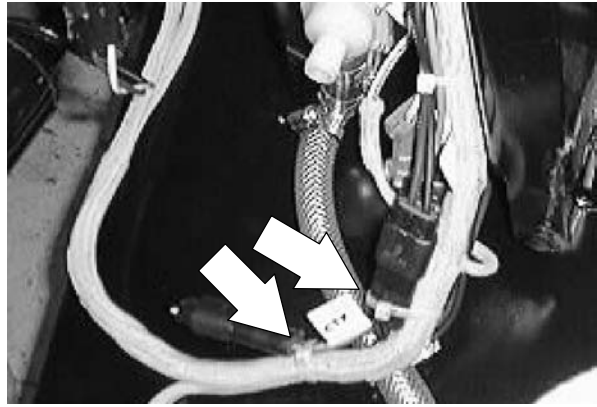

9. Turn on the machine and *lower* the scrub head. Shut off the key.



10. Go under the machine in the area of the center of the scrub head. Reinstall the **UPPER** head lift roller into the mount bracket. Reinstall the roller mount screw and tighten to 18 - 24 Nm (15 - 20 ft lb).

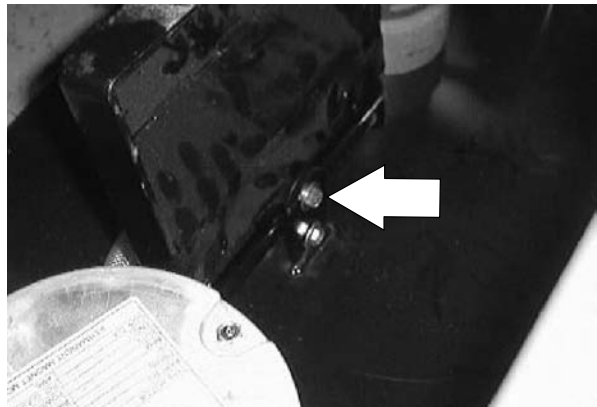

11. Reconnect the end of the side shift cable where it attaches to the scrub head.

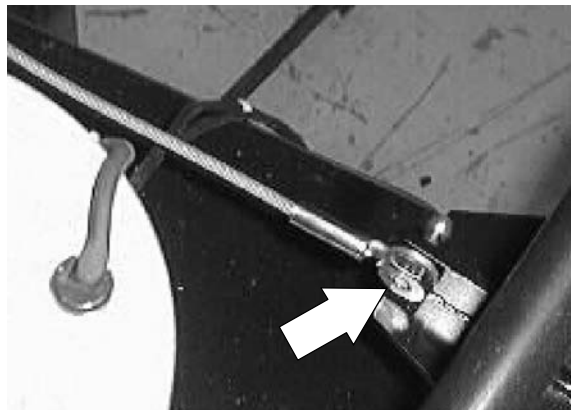

12. Reconnect the end of the side shift gas spring where it attaches to the scrub head.



13. Turn on the machine and *raise* the scrub head. Check the scrub head for proper operation.

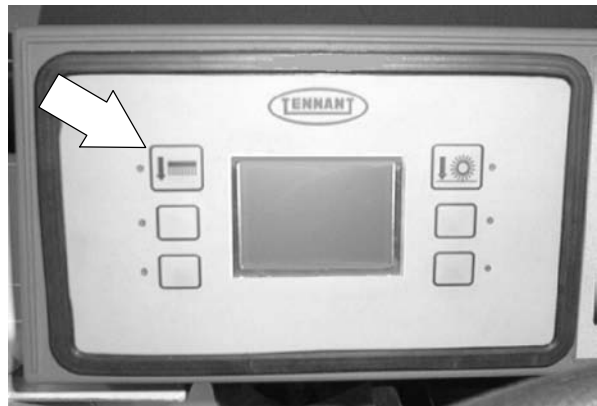

SCRUBBING

TO REMOVE THREE MOTOR DISC SCRUB HEAD (MAXPRO 1200)

FOR SAFETY: Before Leaving Or Servicing Machine; Stop On Level Surface, Set Parking Brake.

1. Turn on the machine and *lower* the scrub head. Shut off the key.



2. Go under the machine in the area of the center of the scrub head. Remove the hex screw holding the **UPPER** head lift roller to the mount bracket. Remove the roller from the scrub head frame.

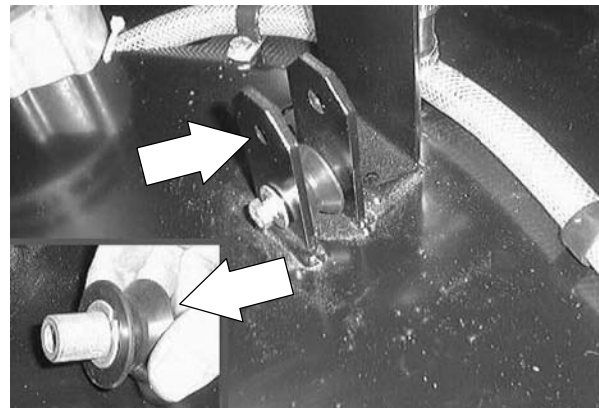

3. Turn on the machine and *raise* the scrub head. Turn off the key.

4. Remove any plastic ties holding the wires and solution lines to the scrub head.

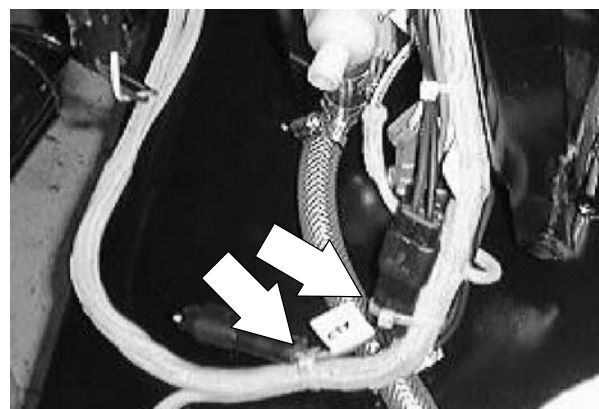

5. Disconnect the three scrub brush motors from the main harness.

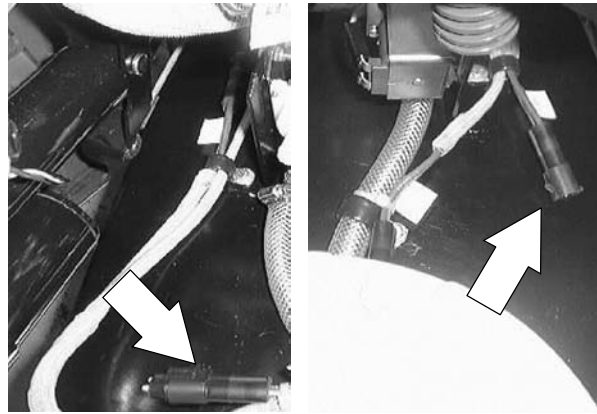

6. Disconnect the water flow solenoid from the main harness.

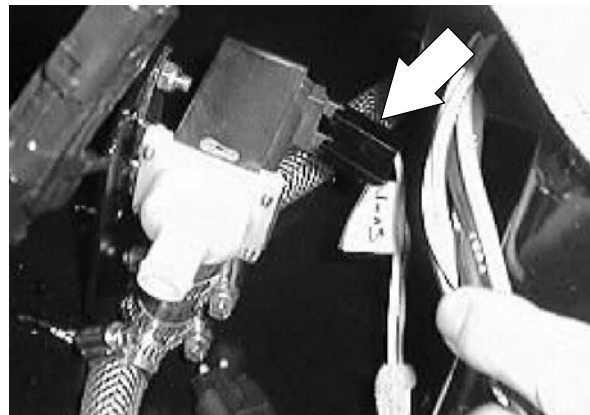

7. Disconnect the solution line from the water flow solenoid.

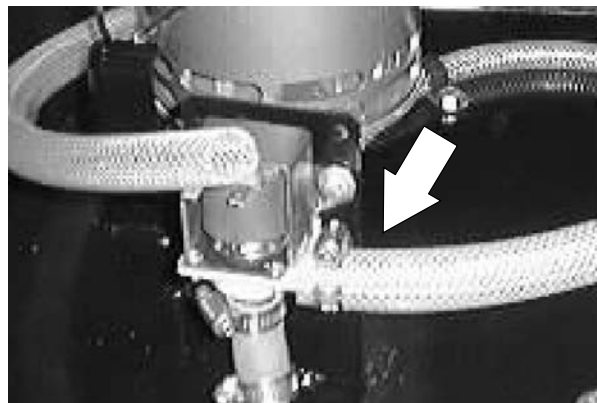

8. Disconnect the end of the side shift gas spring where it attaches to the scrub head.



SCRUBBING

9. Disconnect the end of the side shift cable where it attaches to the scrub head.

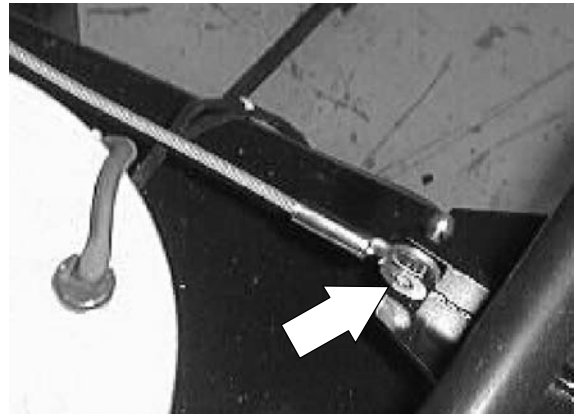

10. Remove the cotter pins and castle nuts from the end of the scrub head drag links where they attach to the machine frame.

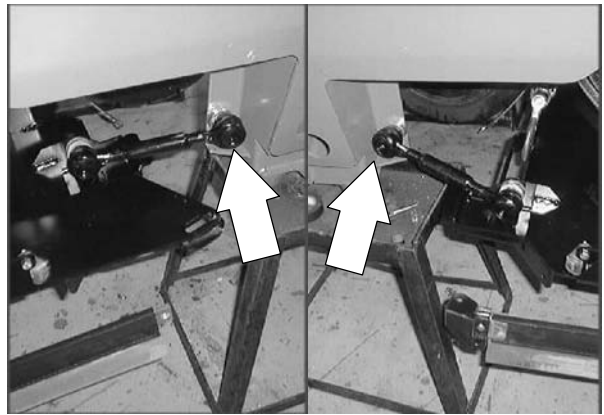

11. Pull the drag links out of the frame mount holes.

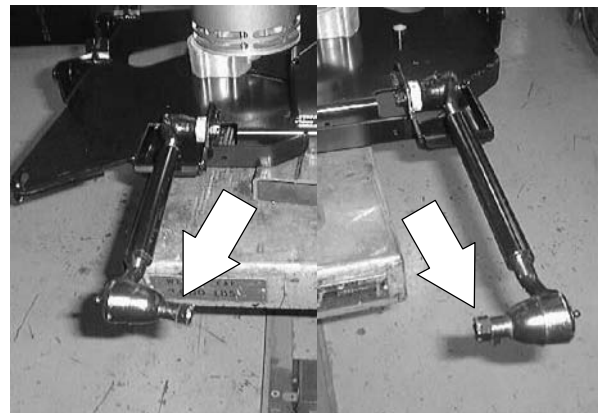

12. **If a hoist is available--**raise the front of the machine and place jackstands under the corners of the machine frame.



13. Push or pull the scrub head out the right side (operators compartment side) of the machine. The scrub head can now be removed from the machine.

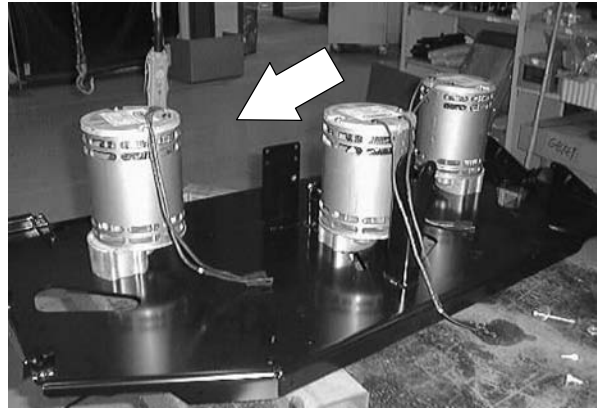

SCRUBBING

TO INSTALL THREE MOTOR DISC SCRUB HEAD (MAXPRO™ 1200)

FOR SAFETY: Before Leaving Or Servicing Machine; Stop On Level Surface, Set Parking Brake.

1. **If a hoist is available--**raise the front of the machine and place jackstands under the corners of the machine frame.

NOTE: Latch the side squeegees in the double scrub position. Leave the scrub brushes on the scrub head.



2. Push or pull the scrub head into the right side (operator's compartment side) of the machine. Push the head in until it is centered in the frame.



3. Position the two scrub head drag links into the frame mount holes.

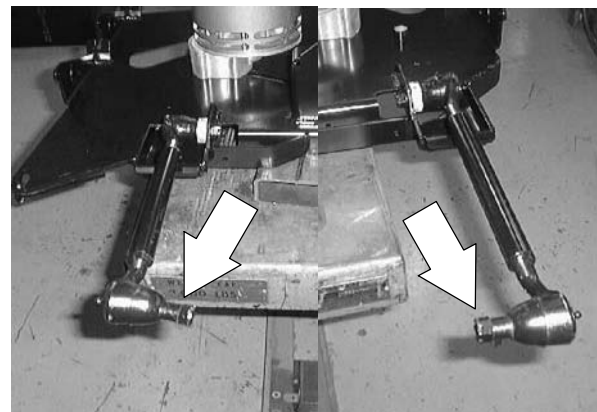

4. Reinstall the castle nuts onto the end of the scrub head drag links where they attach to the machine frame. Tighten the castle nuts tight. Reinstall the cotter pins.

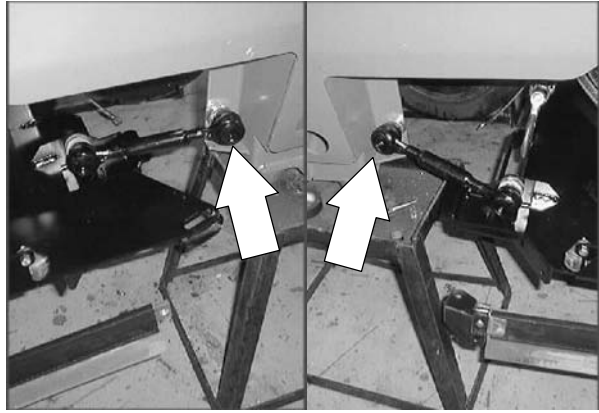

5. Reconnect the three scrub brush motors to the main harness.

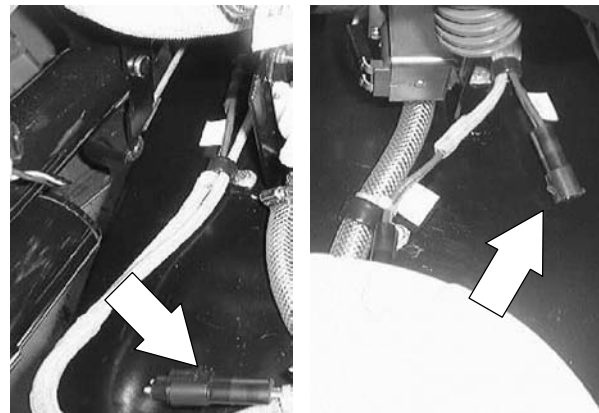

6. Reconnect the water flow solenoid to the main harness.

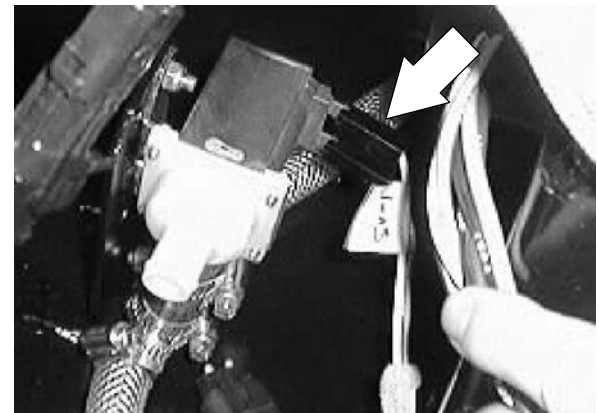

7. Reconnect the solution line to the water flow solenoid.



SCRUBBING

8. Use plastic ties to secure electrical wires and solution lines.

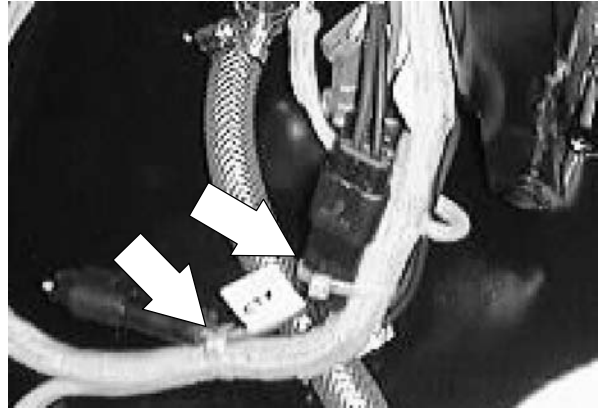

9. Turn on the machine and *lower* the scrub head. Shut off the key.



10. Go under the machine in the area of the center of the scrub head. Reinstall the **UPPER** head lift roller into the mount bracket. Reinstall the roller mount screw and tighten to 18 - 24 Nm (15 - 20 ft lb).

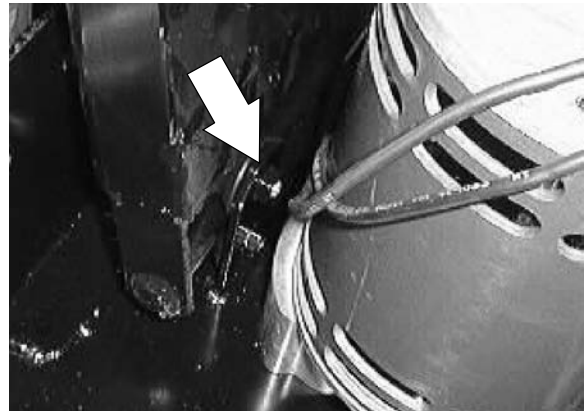

11. Reconnect the end of the side shift cable where it attaches to the scrub head.

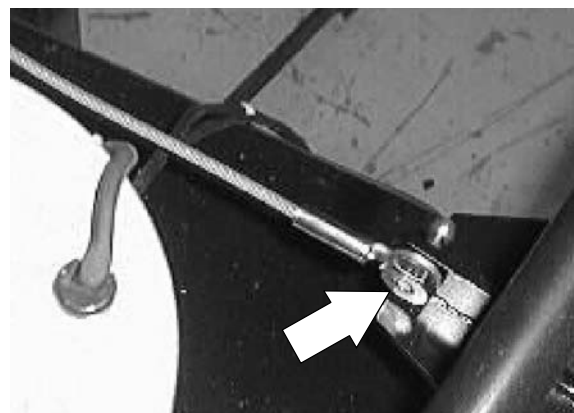

12. Reconnect the end of the side shift gas spring where it attaches to the scrub head.



13. Turn on the machine and *raise* the scrub head. Check the scrub head for proper operation.

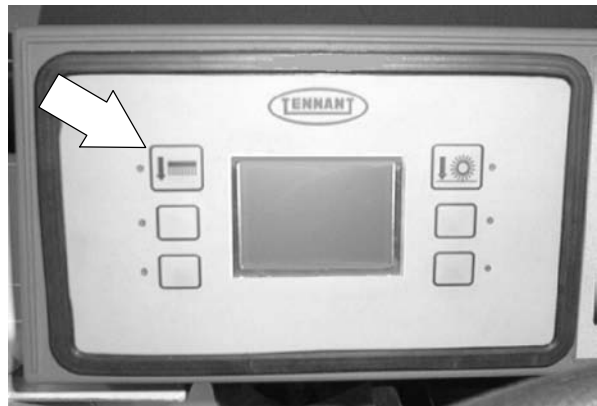

SCRUBBING

TO REMOVE CYLINDRICAL SCRUB HEAD (MAXPRO™ 1000 AND 1200)

FOR SAFETY: Before Leaving Or Servicing Machine; Stop On Level Surface, Set Parking Brake.

1. Turn on the machine and *lower* the scrub head. Shut off the key.

NOTE: Latch the side squeegees in the double scrub position. Leave the scrub brushes on the scrub head.



2. Remove the debris tray from the right side of the machine.

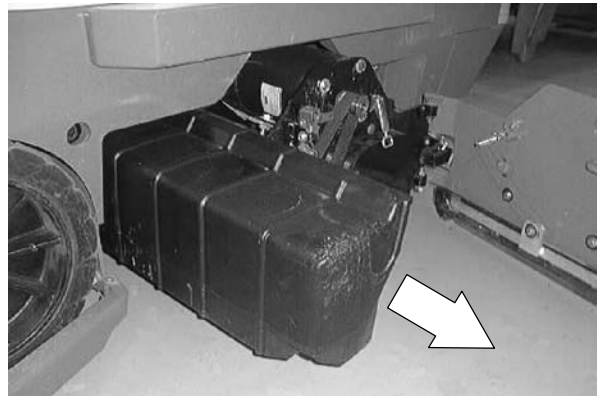

3. Go under the machine in the area of the center of the scrub head. Remove the hex screw holding the **UPPER** head lift roller to the mount bracket. Remove the roller from the scrub head frame.

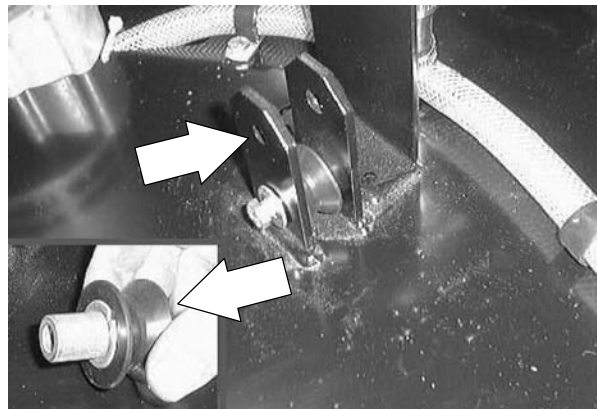

4. Turn on the machine and *raise* the scrub head. Turn off the key.
5. Remove any plastic ties holding the wires to the scrub head.



6. Disconnect the two scrub brush motors from the main harness.

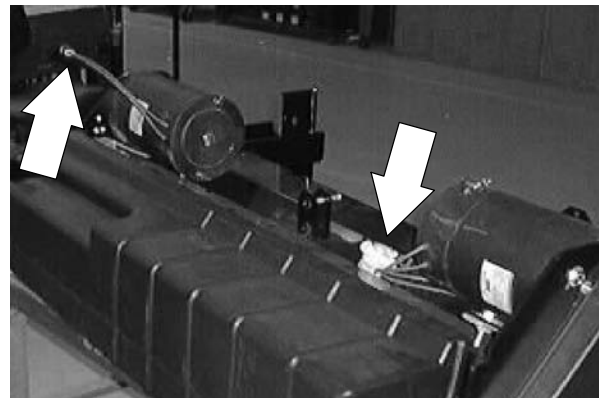

7. Disconnect the water flow solenoid from the main harness.

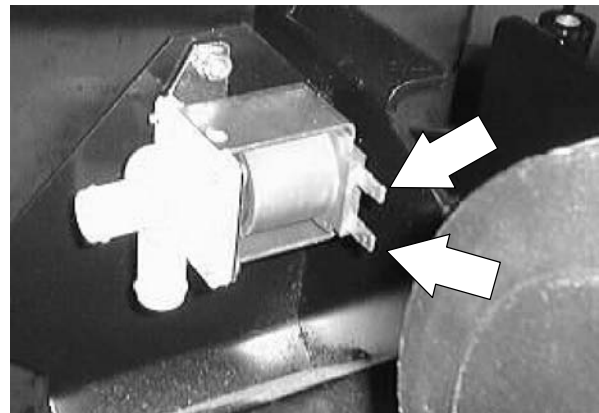

8. Disconnect the solution line from the water flow solenoid.

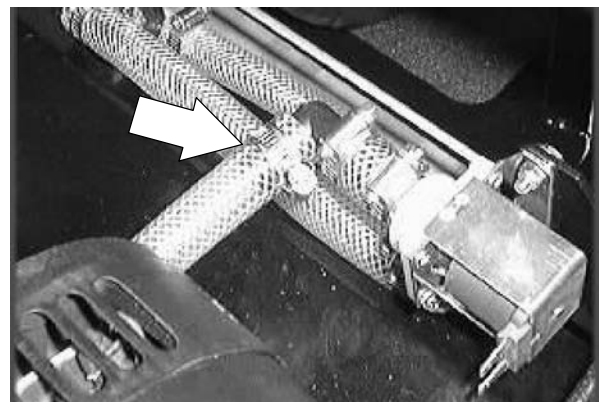

SCRUBBING

9. Disconnect the end of the side shift gas spring where it attaches to the scrub head.

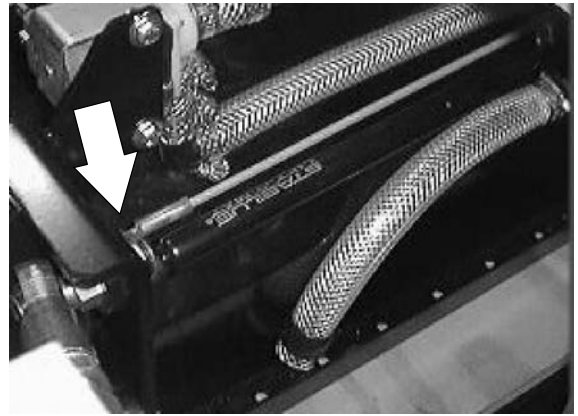

10. Disconnect the end of the side shift cable where it attaches to the scrub head.

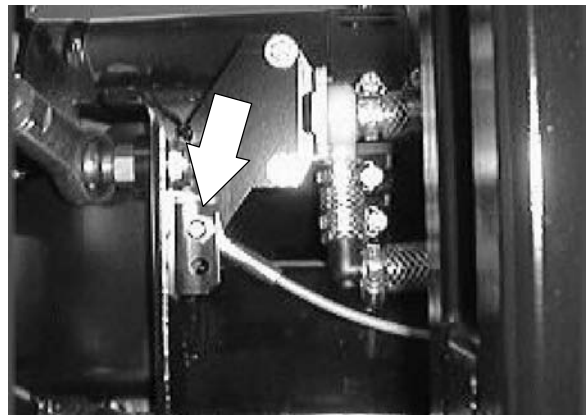

11. Remove the cotter pins and castle nuts from the end of the **LOWER** scrub head drag links where they attach to the machine frame.



12. Remove the larger nyloc nut from the **UPPER** scrub head drag links where they attach to the machine frame.

13. Pull the drag links out of the frame mount holes. Disconnect the kick-in guard from the front, right corner of the scrub head.



14. **If a hoist is available--**raise the front of the machine and place jackstands under the corners of the machine frame.

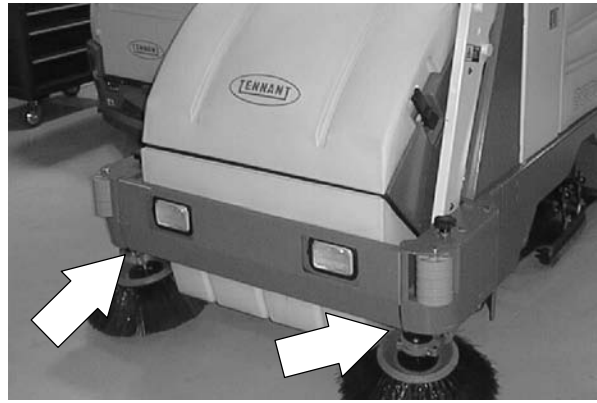

15. Push or pull the scrub head out the right side (operators compartment side) of the machine. The scrub head can now be removed from the machine.

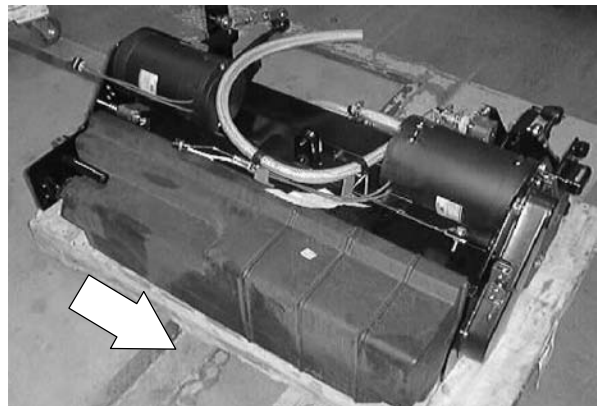

SCRUBBING

TO INSTALL CYLINDRICAL SCRUB HEAD (MAXPRO 1000 AND 1200)

FOR SAFETY: Before Leaving Or Servicing Machine; Stop On Level Surface, Set Parking Brake.

1. **If a hoist is available--**raise the front of the machine and place jackstands under the corners of the machine frame.

NOTE: Latch the side squeegees in the double scrub position. Leave the scrub brushes on the scrub head.

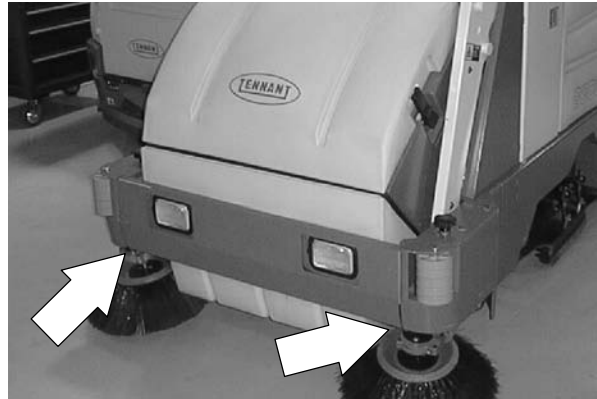

2. Push or pull the scrub head into the right side (operator's compartment side) of the machine. Push the head in until it is centered in the frame.

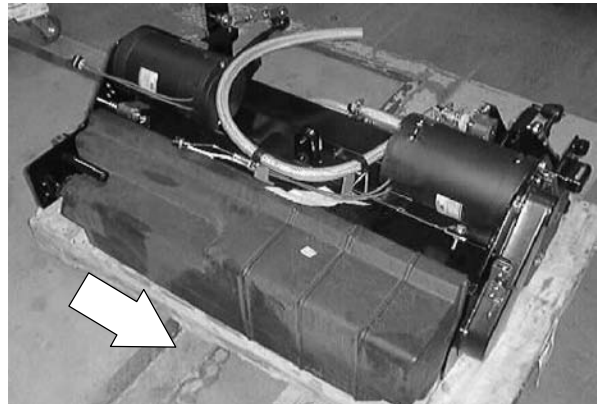

3. Position the four scrub head drag links into the frame mount holes.

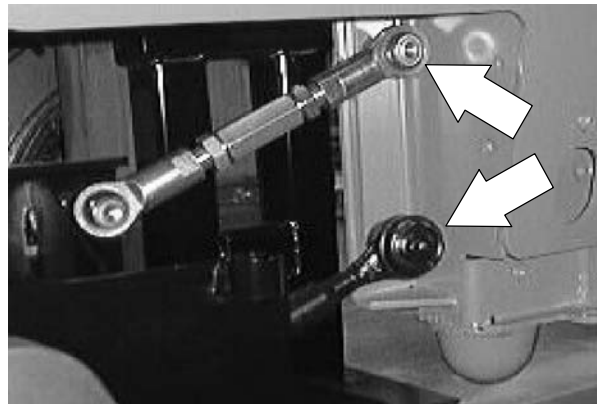

- Reinstall the larger nyloc nut onto the **UPPER** scrub head drag links where they attach to the machine frame. Tighten to 64 - 83 Nm (47 - 61 ft lb).

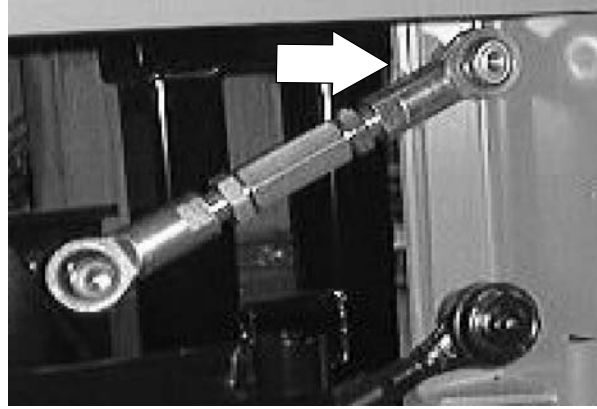

- Reinstall the castle nuts onto the end of the **LOWER** scrub head drag links where they attach to the machine frame. Tighten the castle nuts tight. Reinstall the cotter pins.

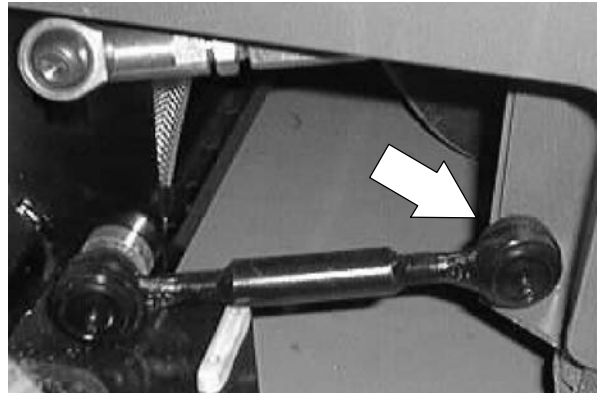

- Reconnect the two scrub brush motors to the main harness.

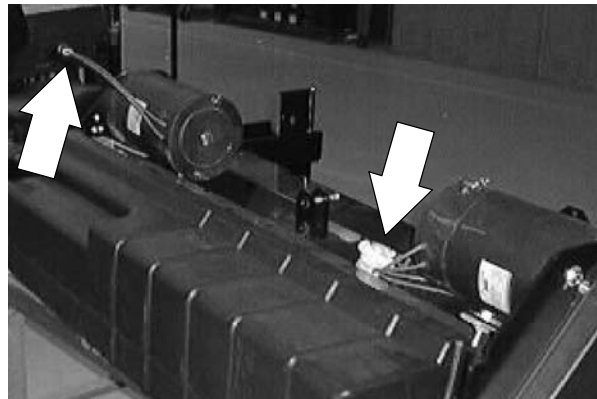

- Reconnect the water flow solenoid to the main harness.

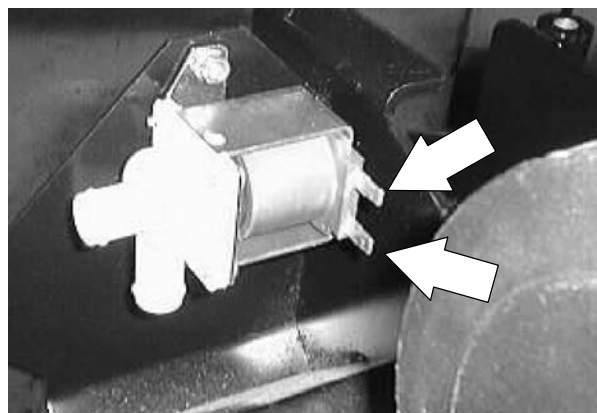

SCRUBBING

8. Reconnect the solution line to the water flow solenoid.
9. Use plastic ties to secure electrical wires and solution lines.

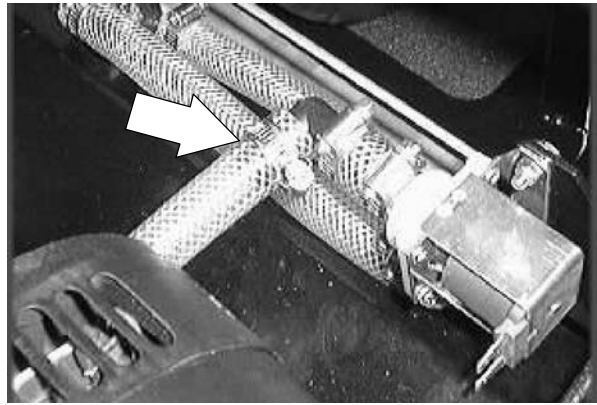

10. Turn on the machine and *lower* the scrub head. Shut off the key.



11. Go under the machine in the area of the center of the scrub head. Reinstall the **UPPER** head lift roller into the mount bracket. Reinstall the roller mount screw and tighten to 18 - 24 Nm (15 - 20 ft lb).

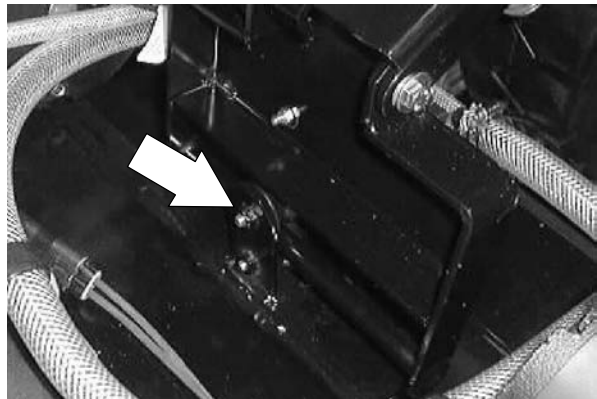

12. Reconnect the end of the side shift cable where it attaches to the scrub head.

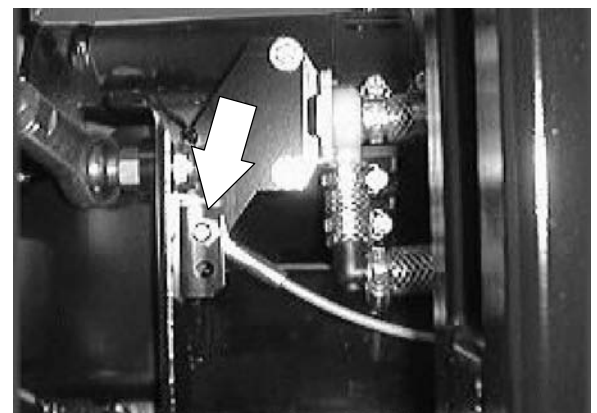

13. Reconnect the end of the side shift gas spring where it attaches to the scrub head. Reconnect the kick-in guard to the front, right corner of the scrub head.

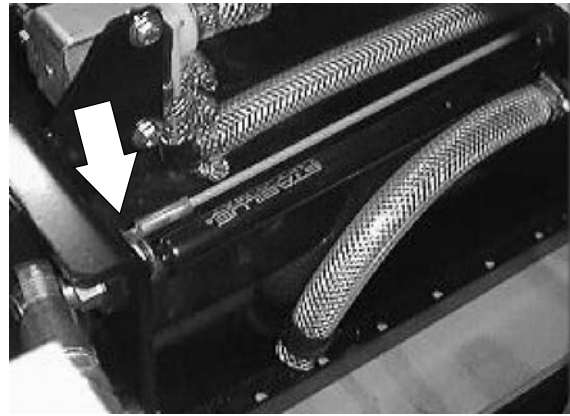

14. Turn on the machine and *raise* the scrub head. Check the scrub head for proper operation.

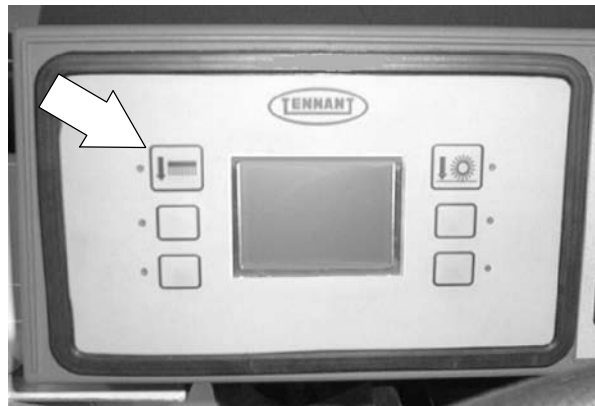

15. Reinstall the debris tray into the right side of the machine.



16. Operate the machine and check the scrub head for proper operation.

SCRUBBING

TO REPLACE CYLINDRICAL SCRUB HEAD DRIVE PLUG SHAFT BEARINGS

**FOR SAFETY: Before Leaving Or
Servicing Machine; Stop On Level
Surface, Set Parking Brake.**

1. Remove the scrub brush from the drive plug. See TO REPLACE CYLINDRICAL SCRUB BRUSH instructions in this section.

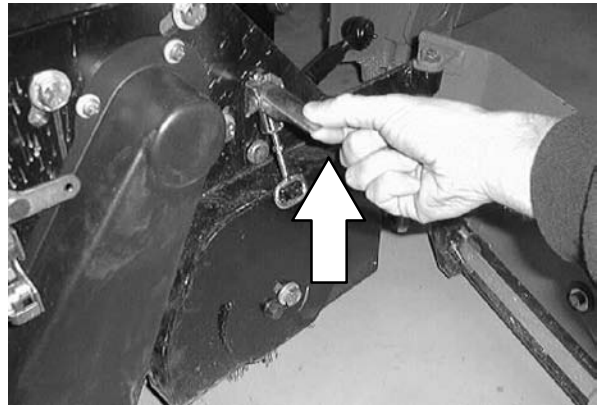

2. Remove the cogged drive belt from the scrub brush drive sheave. See TO REPLACE CYLINDRICAL SCRUB HEAD BRUSH MOTOR instructions in the ELECTRICAL section.

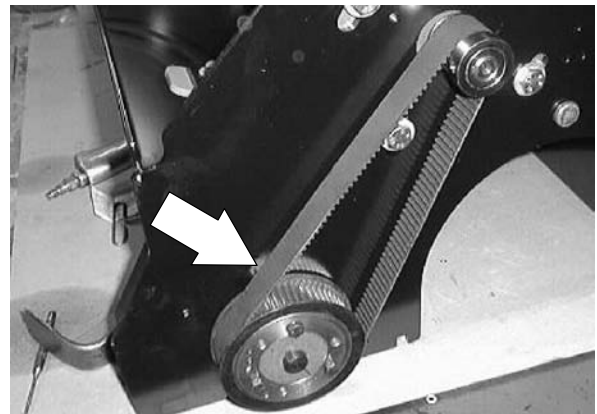

3. Remove the three hex screws holding the cogged drive sheave to the shaft hub.

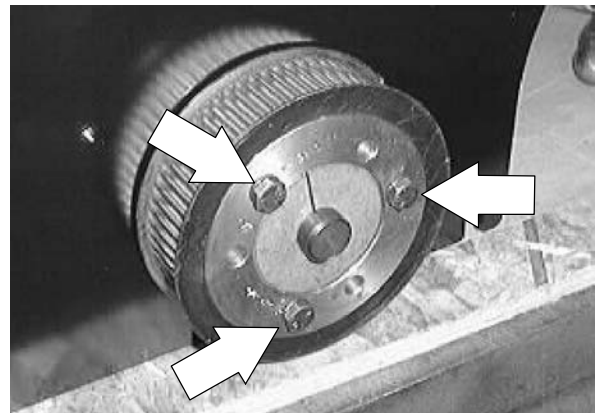

4. Screw the three hex screws into the open holes on the cogged sheave and tighten. This will push the cogged sheave off the shaft hub

NOTE: Make sure to note the location of the sheave on the shaft.

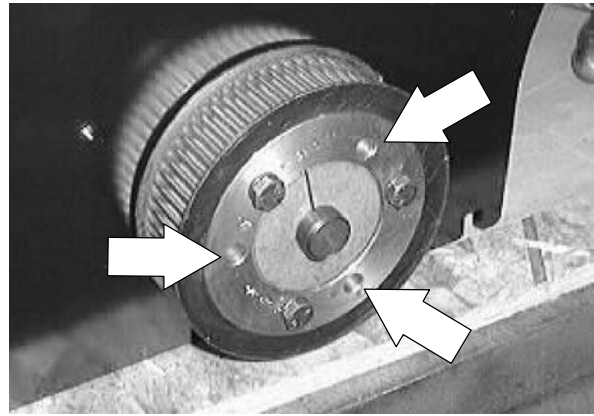

5. Loosen the set screw holding the shaft hub to the square key and shaft. Use a pry bar to remove the shaft hub from the shaft.

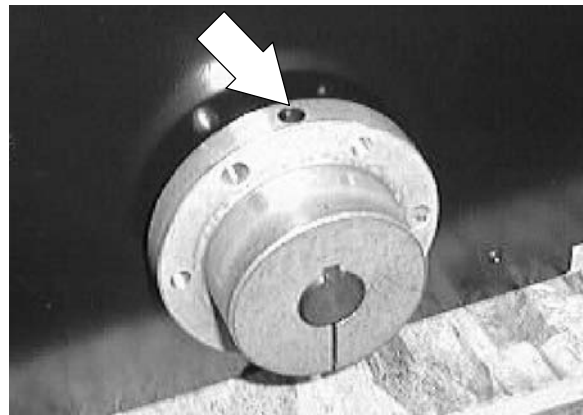

6. Remove the snap ring from the end of the outside shaft bearing.

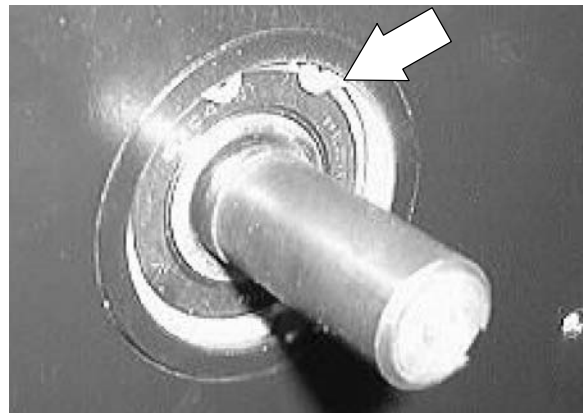

7. Remove the screw and washer holding the scrub brush drive plug to the shaft.

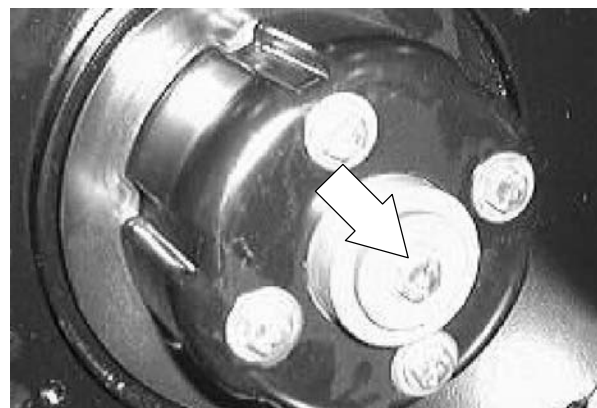

SCRUBBING

8. Remove the drive plug from the shaft.

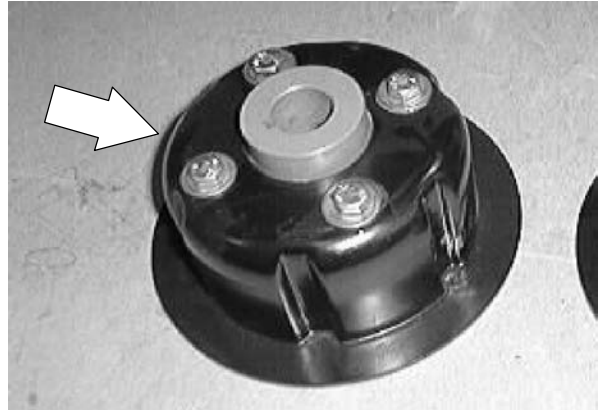

9. Remove the snap ring from the end of the *inside* shaft bearing.

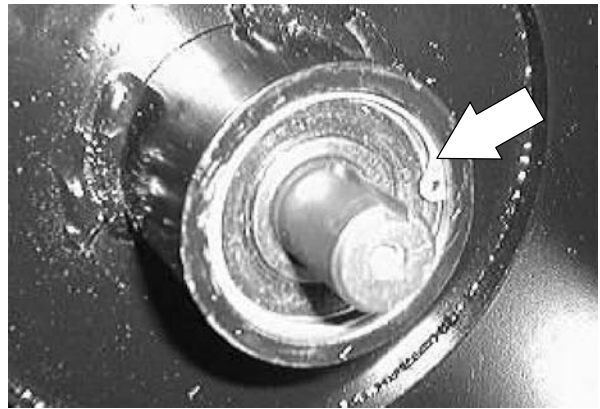

10. Use a rubber hammer to tap the shaft and bearing assembly out of the bearing housing (*tap the assembly into the center of the scrub head*). **Note the orientation of the shaft in the housing.**

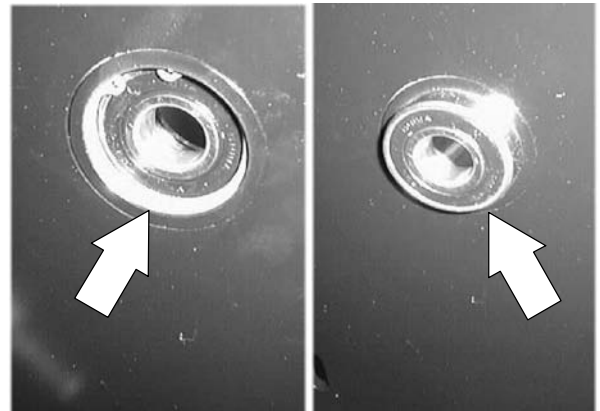

11. Use a press to remove the bearings from the shaft assembly.

12. Install the new bearings and shaft assembly into the bearing housing (*tap the assembly into the housing from the center of the scrub head to the outside of the scrub head*). **The longer shaft end goes to the outside of flange.**

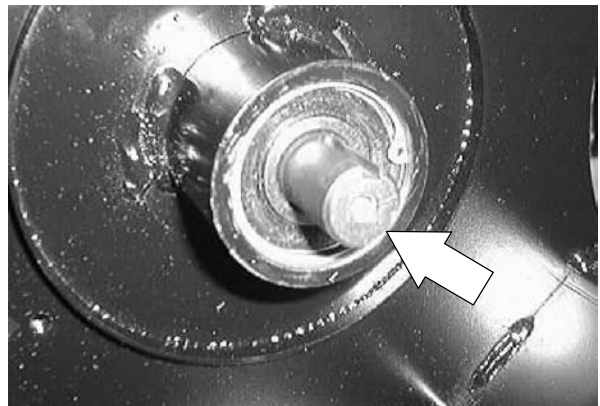

13. Reinstall both bearing snap rings.

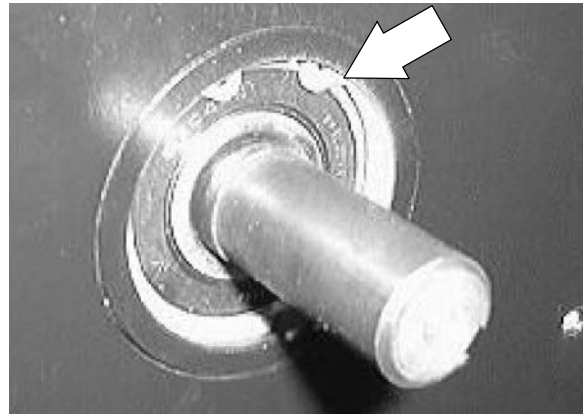

14. Reinstall the scrub brush drive hub onto the shaft on the inside of the shaft. Reinstall the hex screw and tighten to 8 - 10 Nm (5 - 7 ft lb). *Make sure the square key is in place on the shaft.*

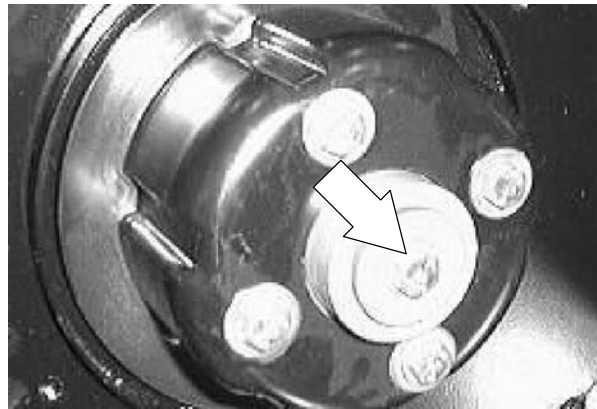

15. Reinstall the cogged sheave shaft hub onto the outside of the shaft and bearing assembly. *Make sure the square key is in place on the shaft.* Position the hub flush with the end of the shaft. *Hand tighten the set screw tight.*

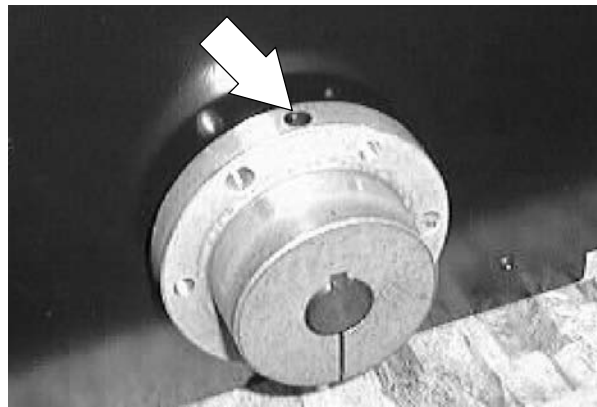

16. Position the cogged sheave onto the shaft hub. Reinstall the three hex screws. Tighten to 8 - 10 Nm (5 - 7 ft lb).

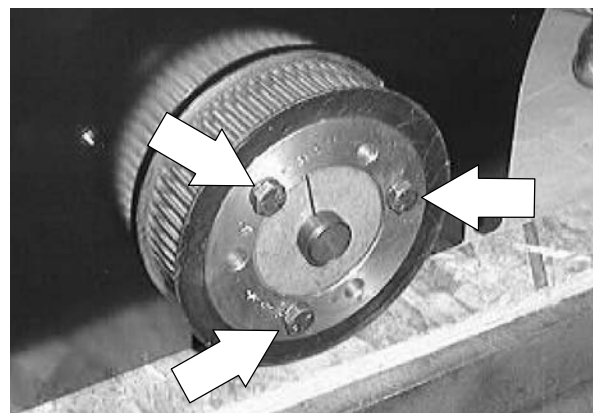

SCRUBBING

17. Reinstall the cogged drive belt onto the scrub brush drive sheave. See TO REPLACE CYLINDRICAL SCRUB HEAD BRUSH MOTOR instructions in the ELECTRICAL section.

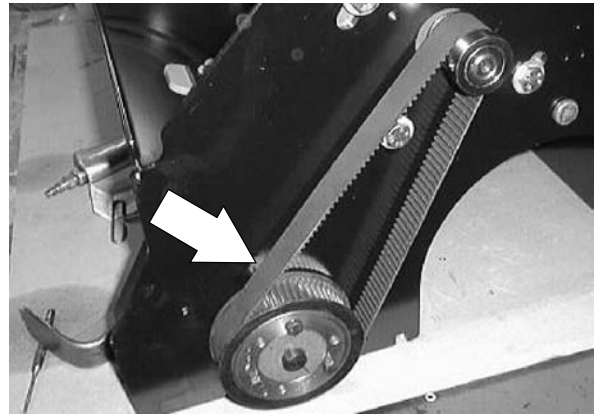

18. Reinstall the scrub brush onto the drive plug. See TO REPLACE CYLINDRICAL SCRUB BRUSH instructions in this section.

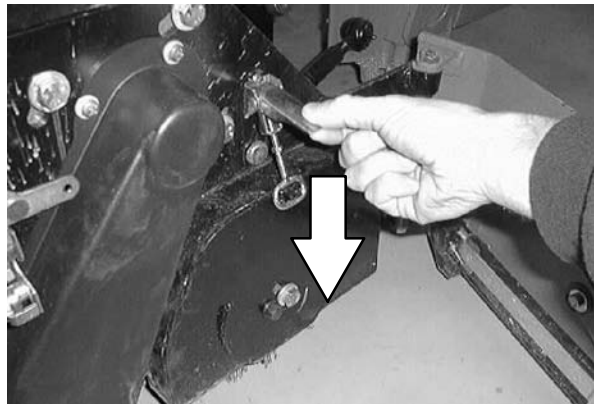

19. Operate the machine and check the scrub head for proper operation.

**TO REPLACE CYLINDRICAL SCRUB HEAD
IDLER PLUG SHAFT BEARING**

**FOR SAFETY: Before Leaving Or
Servicing Machine; Stop On Level
Surface, Set Parking Brake.**

1. Unlatch the brush idler plate latch. See TO REPLACE CYLINDRICAL SCRUB BRUSH instructions in this section.

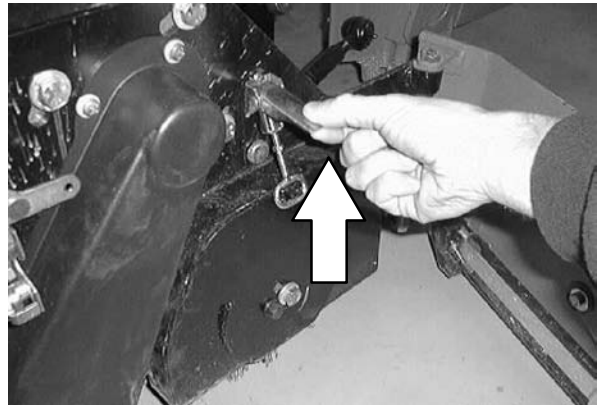

2. Remove the scrub brush idler plate from the scrub head.



3. Remove the hex screw holding the brush idler plug and cam assembly to the mount plate.

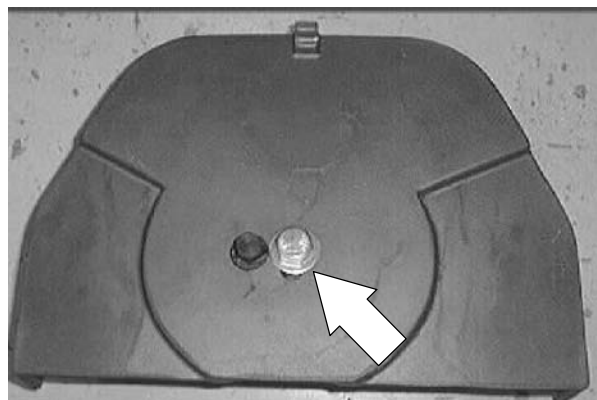

SCRUBBING

4. Use a mechanical press to remove the cam from the idler bearing.

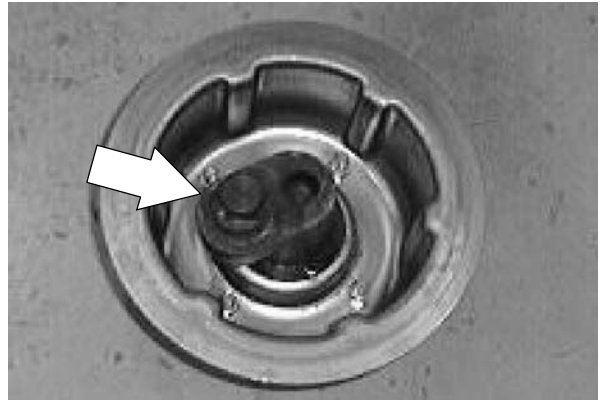

5. Remove the four screws holding the bearing retainer plate to the idler hub.

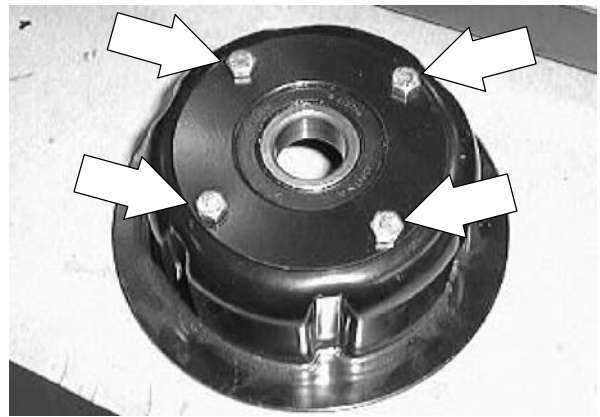

6. Remove the retainer plate to expose the idler bearing.



7. Use a mechanical arbor press to remove the existing bearing and to install the new bearing.

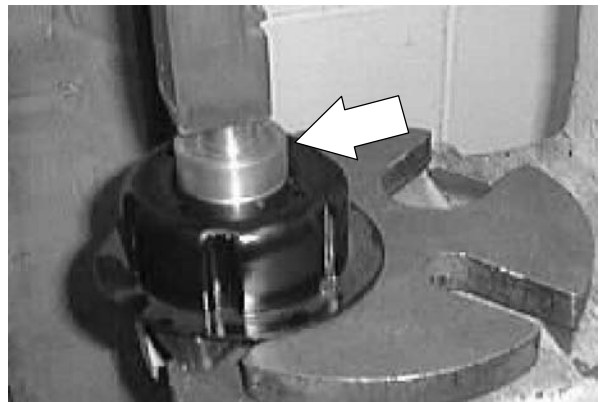

- Reinstall the retainer plate and four screws. Tighten to 443 - 575 Ncm (4 - 6 ft lb).

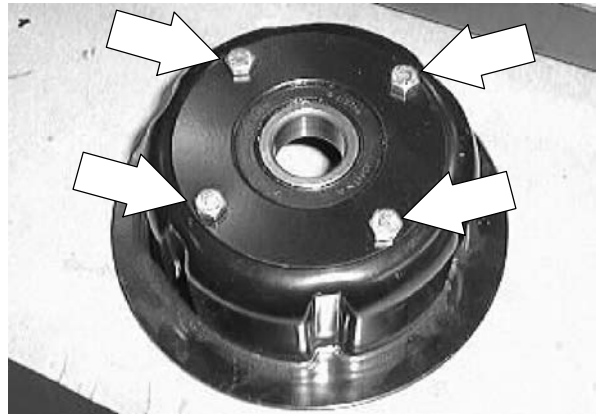

- Use a mechanical arbor press to reinstall the adjustment cam into the new bearing.

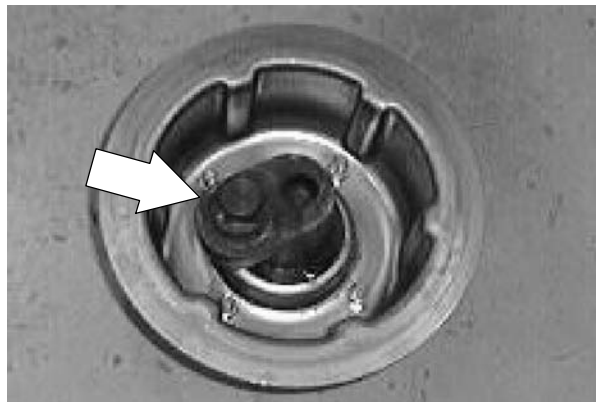

- Reinstall the idler plug assembly onto the mount plate. Leave the hardware loose for now.

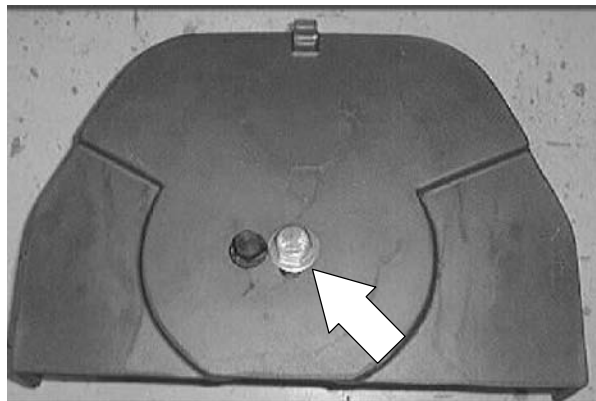

- Reinstall the scrub brush and idler plate onto the scrub head. See TO REPLACE CYLINDRICAL SCRUB BRUSH instructions in this section.

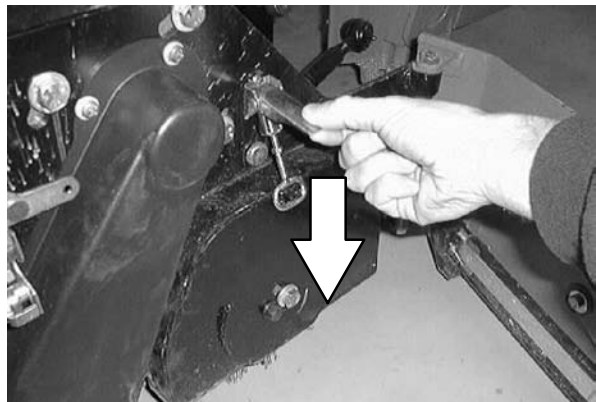

- Operate the machine and check the cylindrical scrub brush patterns. See CHECKING AND ADJUSTING CYLINDRICAL BRUSH PATTERN instructions in this section.

SCRUBBING

DISC SCRUB HEAD SKIRTS

The 8300 disc scrub heads are equipped with rubber skirts front and rear. These skirts control water spray during the scrubbing operation.

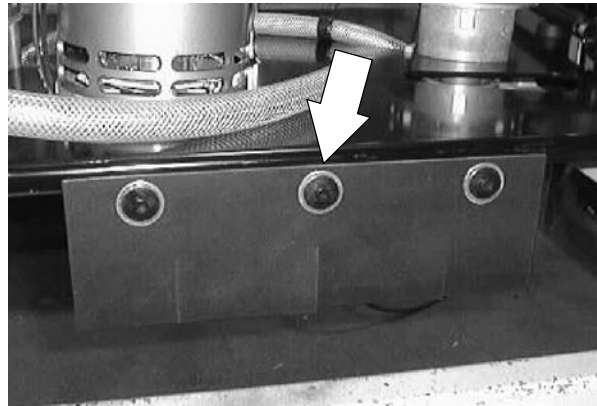

TO REPLACE DISC SCRUB HEAD SKIRTS

FOR SAFETY: Before Leaving Or Servicing Machine; Stop On Level Surface, Set Parking Brake.

1. The disc scrub head skirts are held in place with plastic rivets (10 for the front, 5 for the back).
2. Use a screw driver or pliers to remove the plastic pin from the center of the rivet body.
3. Pull the rivet body out of the mount hole.
4. After all of the plastic rivets have been removed--remove the rubber skirt.
5. Install the new rubber skirt onto the scrub head (note the orientation).
6. Reinstall the plastic rivet bodies.
7. Push the pin into the center of the rivet body. Push the pin all the way in.
8. Repeat this procedure for the front or rear skirt.

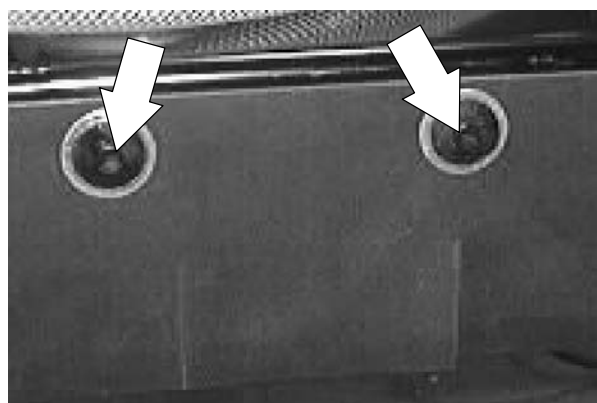
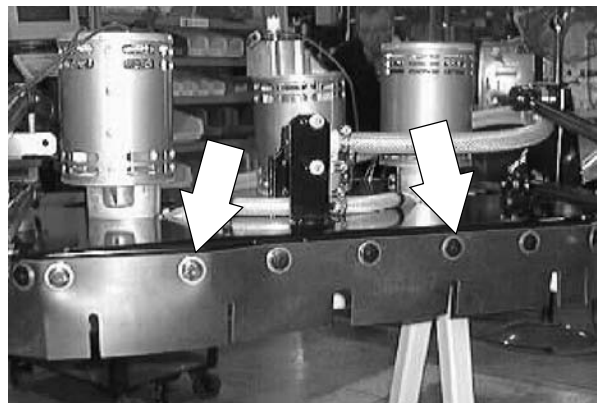

TO ADJUST DISC SCRUB HEAD SKIRTS

The front and rear scrub head skirts on the MAXPRO 1000 and 1200 are not adjustable.

SCRUB BRUSHES

DISC SCRUB BRUSHES

Disc-type scrub brushes scrub the floor. Each scrub brush is driven by its own electric motor to a brush drive hub. A spring lock clip holds the scrub brush onto the drive hub.

There are many variations of brushes and cleaning pads to choose from. There is a brush or cleaning pad available for almost any application. Scrub brushes are ready for use when they are equipped with a brush drive plate and a spring clip.

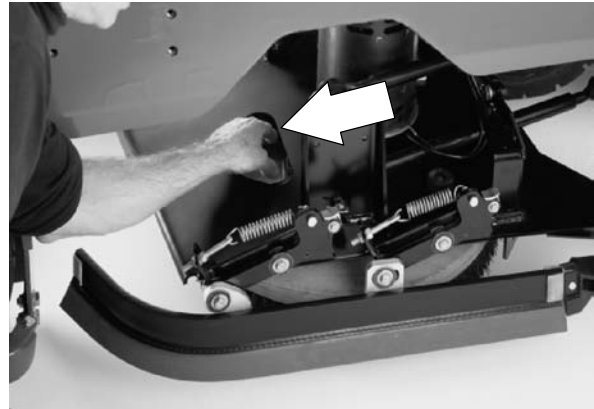

The scrub brushes should be checked daily for tangled wire or string wear damage. The scrub brushes should be replaced if large portions of the brush bristles are missing or if the remaining brush bristle measure 0.38 in (10 mm) or less in length.

NOTE: Be sure to replace the scrub brushes in sets. Otherwise one scrub brush will be more aggressive than the other.



SCRUBBING

TO REPLACE DISC SCRUB BRUSH

FOR SAFETY: Before Leaving Or Servicing Machine; Stop On Level Surface, Set Parking Brake.

1. Turn on the machine and *raise* the scrub head. Turn the machine off.



2. Lift the side squeegee up and engage the double scrub clips.

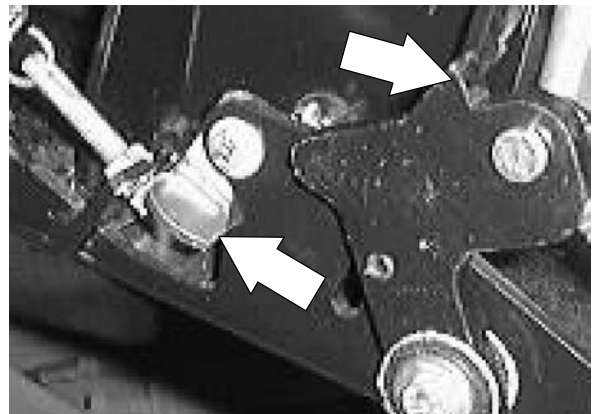

3. Reach into the scrub brush area and spin the scrub brush until the spring clips are visible.



4. Pinch the spring clip together.

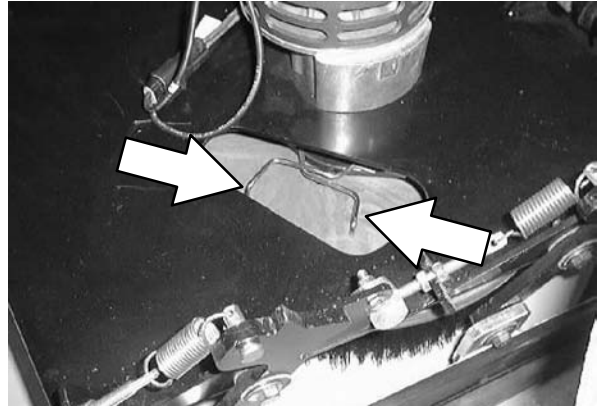

5. Remove the scrub brush from the machine.



6. Position the new scrub brush under the scrub head. Line up the motor drive plug with the brush drive insert.

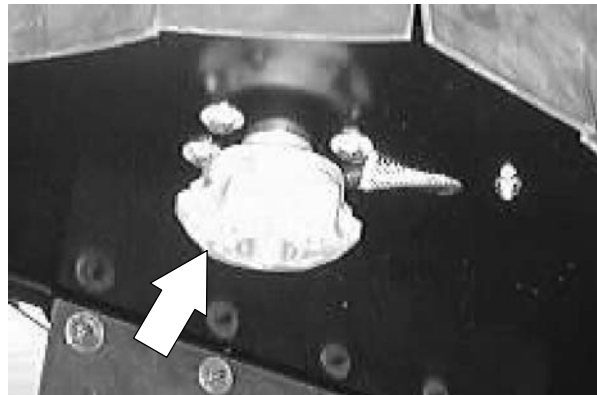

7. Push the scrub brush up until the spring clips lock onto the drive hub.

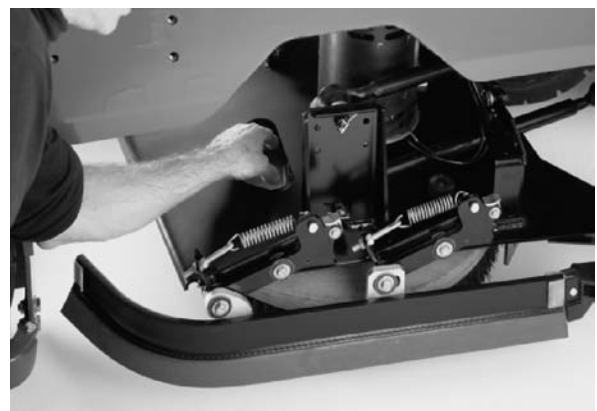

SCRUBBING

CYLINDRICAL SCRUB BRUSHES

Check the brush taper and rotate the brushes from front-to-rear every 50 hours of machine operation for maximum brush life and best scrubbing performance.

The cylindrical brushes should be replaced if large amounts of bristles are missing, or if the remaining bristle length is less than 10 mm (0.38 in).

NOTE: Replace worn brushes in pairs. Scrubbing with brushes of unequal bristle length will result in diminished scrubbing performance.

NOTE: Fill the solution tank before checking or adjusting the brush pattern.

TO REPLACE CYLINDRICAL SCRUB BRUSH

1. Press the scrubbing switch. When the scrub head is approximately 25 mm (1 in) from the floor, turn the machine power off.
2. Set the parking brake.

FOR SAFETY: Before Leaving Or Servicing Machine; Stop On Level Surface, Set Parking Brake.

3. Open the side squeegee support guard with the latch. Swing the support guard outward to access the idler support casting.

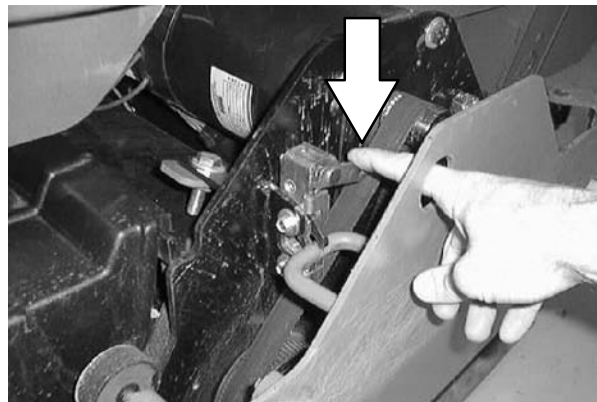
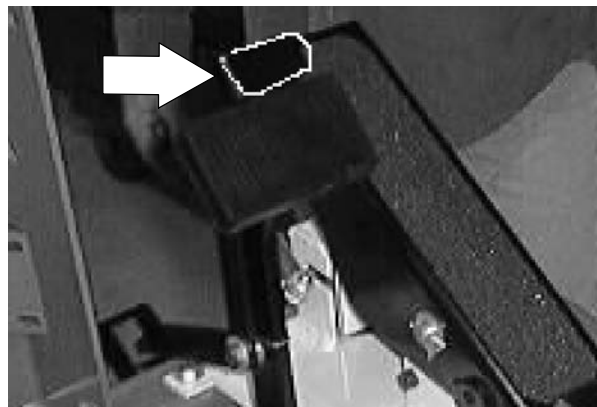

- Lift up on the idler support latch to release the idler support casting.

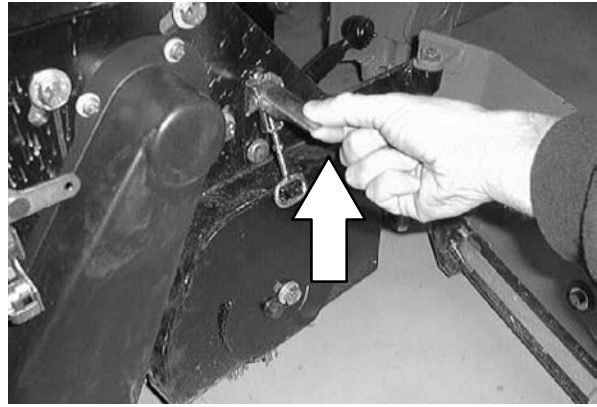

- Pull the idler plug off the brush, and pull the old brush out of the scrub head.

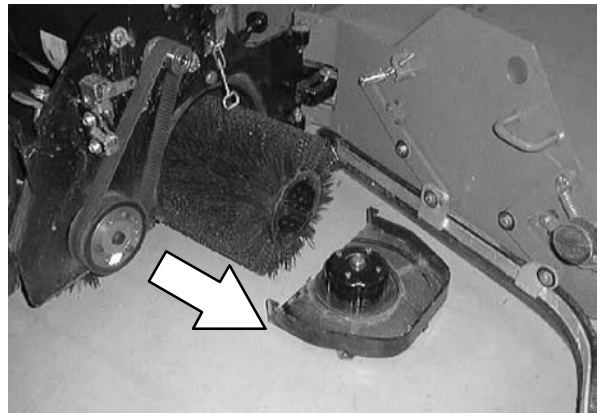

- Position the brush with the *double row end towards you*. Guide the new brush onto the drive hub.



- Insert the Idler plug (on the inside of the idler door), into the brush.

- Secure the idler support casting with the idler support latch.

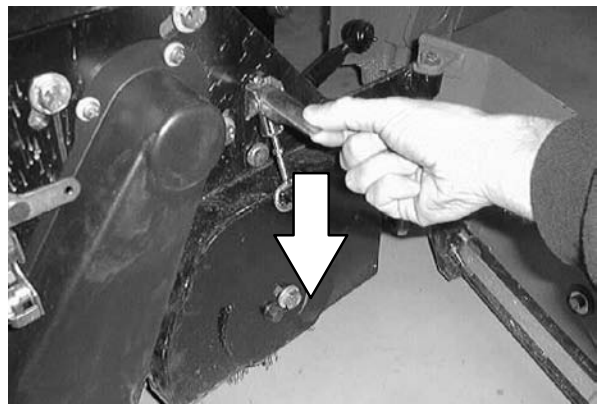

SCRUBBING

9. Firmly close the side squeegee support guard.

10. Repeat for the other brush on the other side of the scrub head.

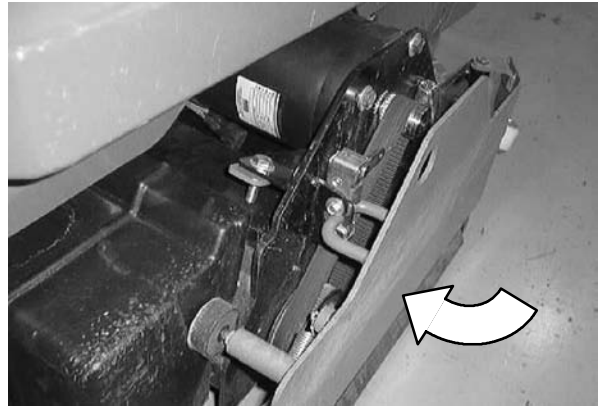

CHECKING AND ADJUSTING CYLINDRICAL BRUSH PATTERN

1. Apply chalk (or another material that will not easily blow away), to a smooth, level section of the floor.
2. Set the parking brake.

NOTE: Use down pressure setting #3 on cylindrical head and down pressure setting #2 on all disc heads.

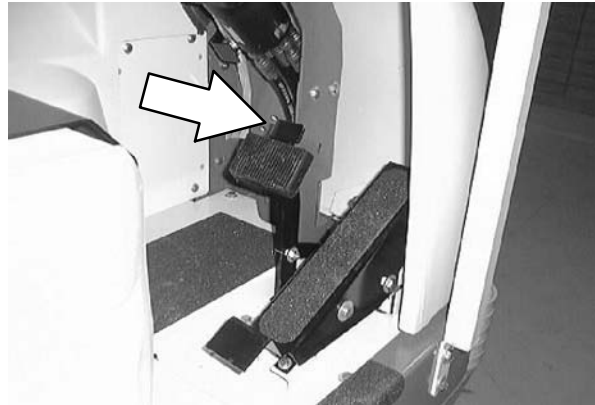

3. Lower the scrub head in the chalked area. Allow the machine to scrub in the same place for 15 to 20 seconds.

NOTE: If chalk or other material is not available, allow the brushes to spin on the floor for two minutes. A polish mark will remain on the floor.

4. Raise the scrub head and move the machine away from the chalked area. Turn the machine power off.
5. Observe the shape of the brush patterns. If the brush patterns have parallel sides, the brushes do not need adjustment.

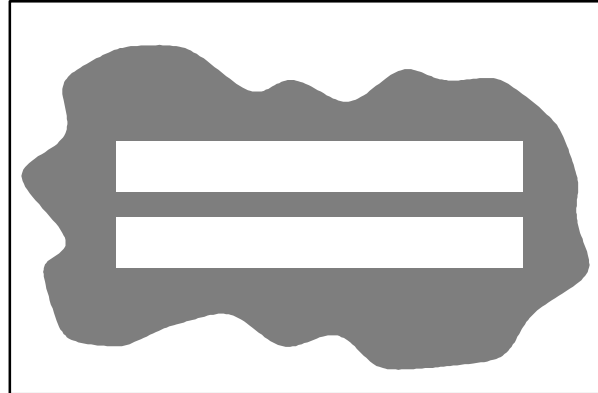

If one, or both of the brush patterns are tapered, the brushes need adjustment to straighten the brush pattern.

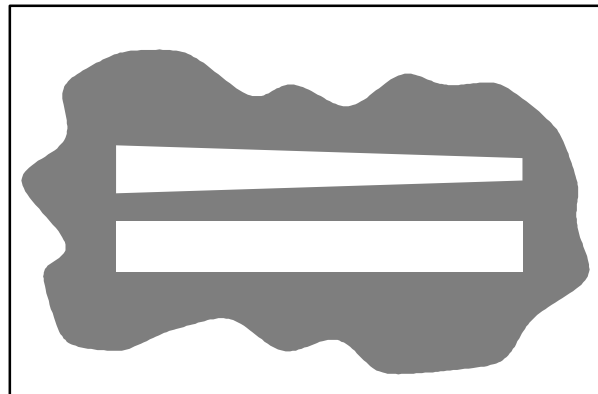

SCRUBBING

1. Open the side squeegee support guard with the latch. Swing the support guard outward to access the idler support casting.

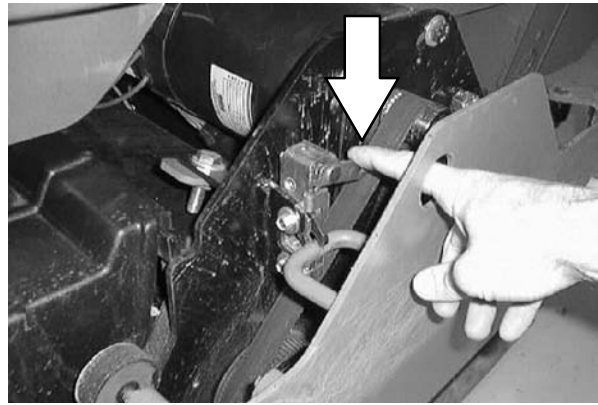

2. While holding the smaller hex, loosen the larger mounting screw on the outside of the idler door.

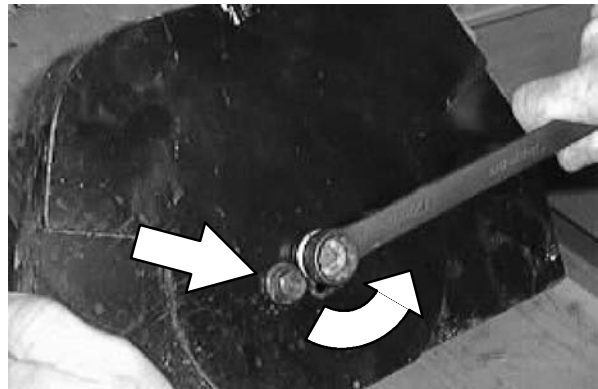

3. Using the smaller hex head - raise or lower the end of the brush as needed to straighten the brush pattern. Tighten the larger mounting screw.

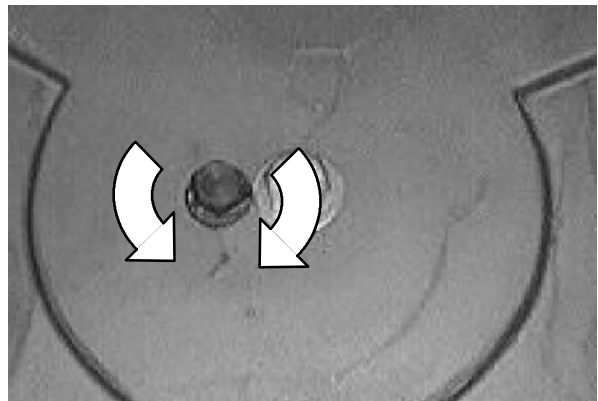

4. Check the brush patterns again and readjust as necessary until both patterns are the same.

6. If one brush pattern is wider than the other, the scrub head needs to be leveled.

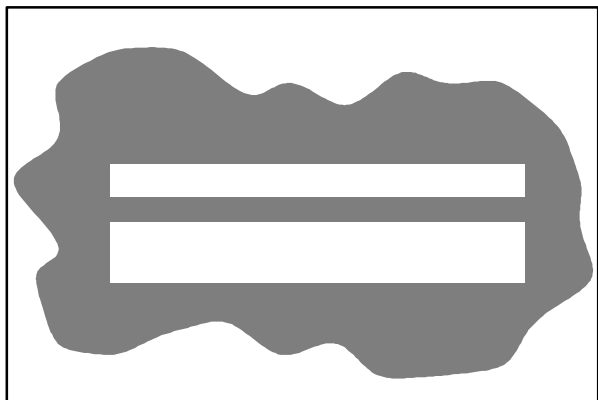

Level the scrub head by turning the scrub head links. Both scrub head links should be adjusted equally.

Check the brush patterns again and readjust as necessary until both patterns are the same.

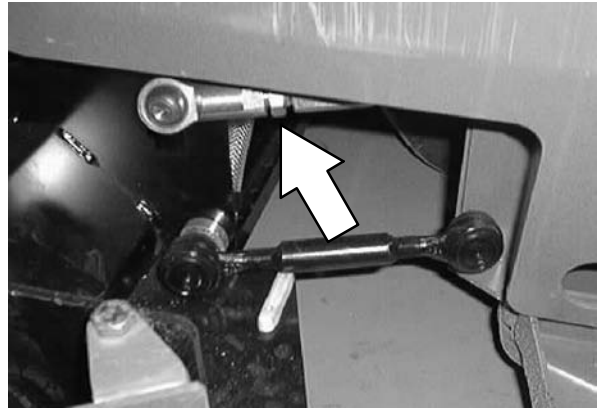

SCRUBBING

MANUAL SOLUTION VALVE

The 8300 manual solution valve is located under the front of the solution/recovery tanks. The manual valve is controlled with the solution lever on the left side of the steering column. The manual valve controls the amount of water going to the electric solution solenoid (located on the scrub head).

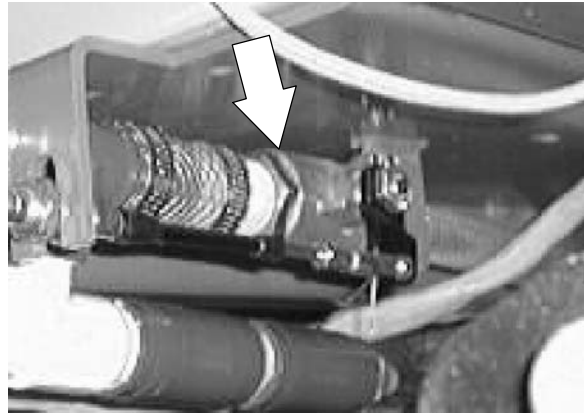

TO REPLACE MANUAL SOLUTION VALVE

FOR SAFETY: Before Leaving Or Servicing Machine; Stop On Level Surface, Set Parking Brake.

1. Make sure the solution tank has been drained.

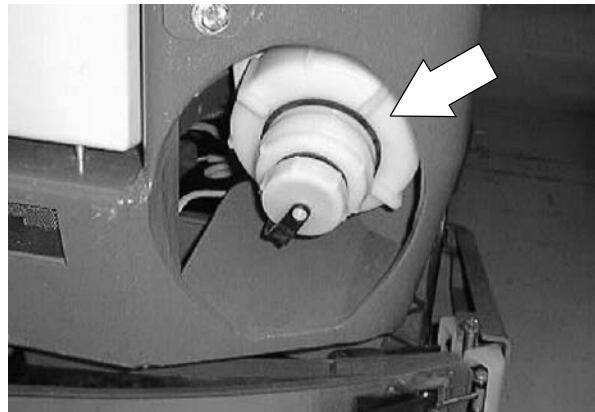

2. Turn on the machine and lower the scrub head. Shut off the key.



3. Loosen the worm drive clamps holding the solution hoses to the manual valve fittings. Pull the hoses off the fittings.

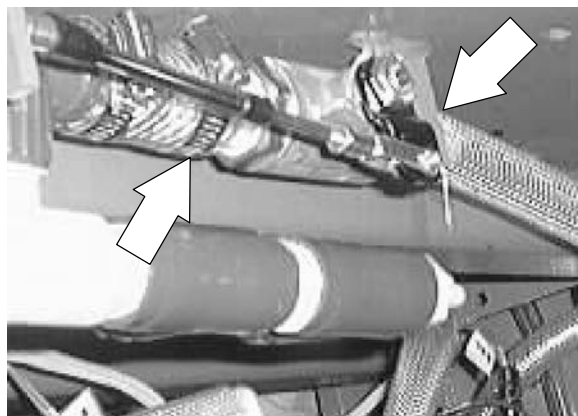

4. Remove the cotter pin and clevis pin holding the push/pull cable clevis to the manual valve lever.

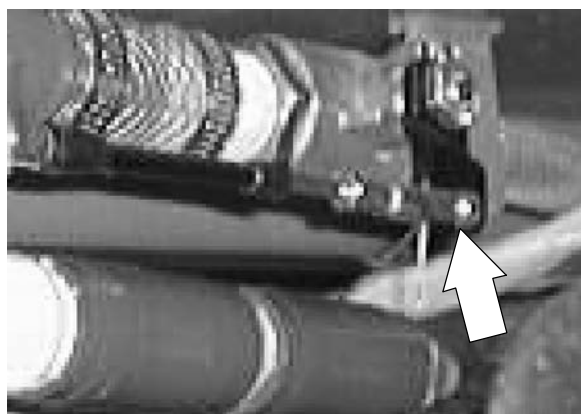

5. Remove the two screws holding the valve to the mount bracket. Remove the valve from the machine.

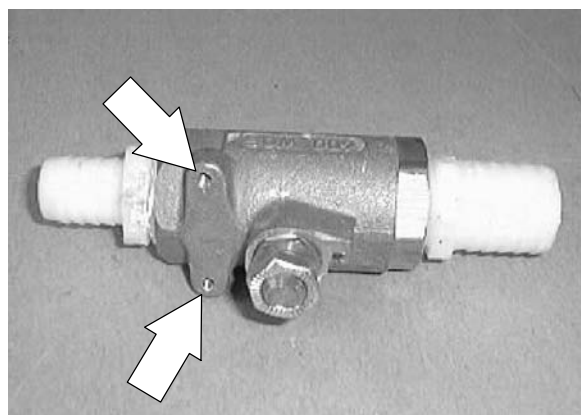

6. Remove the two fittings and install into the new valve.

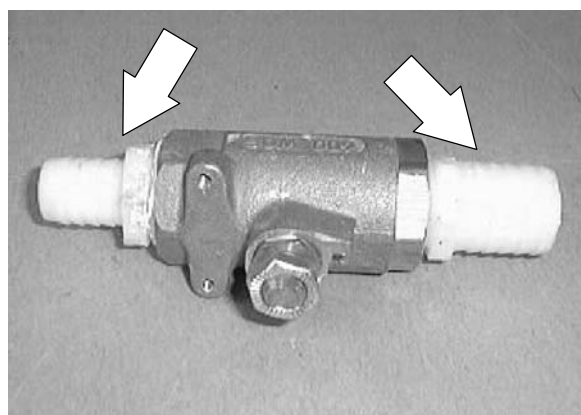

SCRUBBING

7. Remove the nut holding the valve lever to the valve body. Remove the lever and install on the new valve in the same orientation.

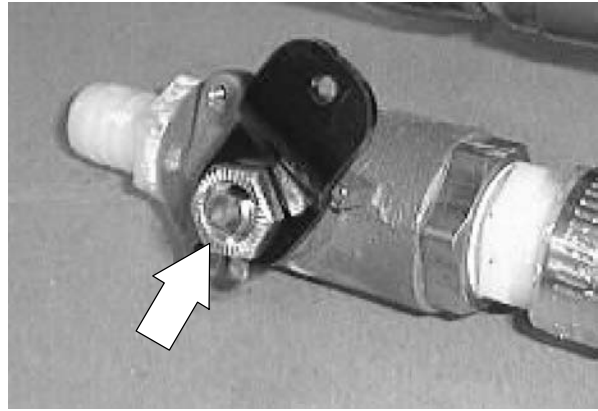

8. Install the new valve assembly onto the mount bracket. Reinstall the hardware and tighten hand tight.

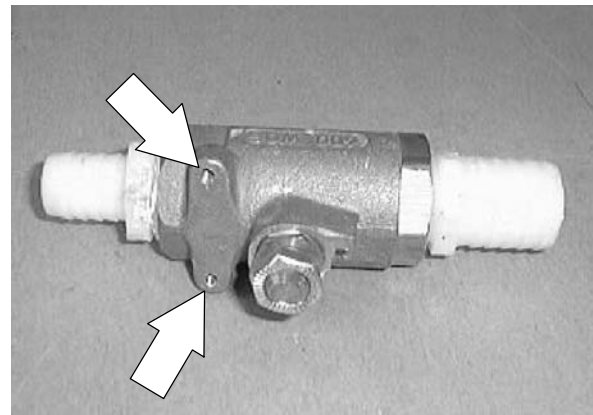

9. Reconnect the two solution hoses to the new valve.

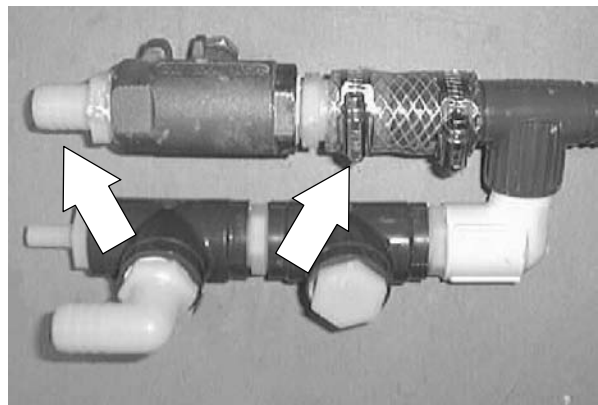

10. Reconnect the push/pull cable to the valve lever. Reinstall the clevis pin and cotter pin.

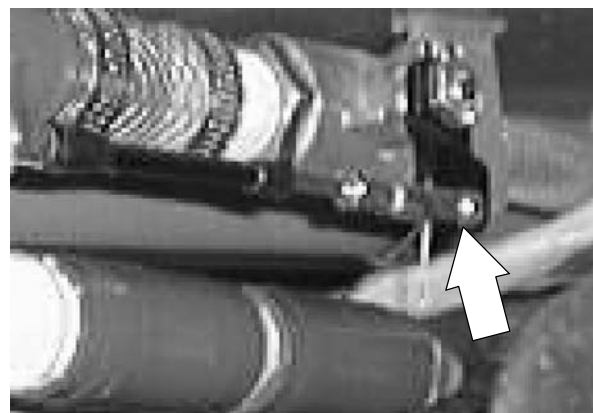

11. Fill the solution tank and check the new valve for proper operation. See TO ADJUST MANUAL WATER VALVE instructions.

TO ADJUST MANUAL SOLUTION VALVE

FOR SAFETY: Before Leaving Or Servicing Machine; Stop On Level Surface, Set Parking Brake.

1. If the manual solution valve needs to be adjusted (to gain more water flow or if valve fails to shut water off completely) remove the machine front cover.



2. Locate the manual solution valve push/pull cable on the left side of the steering column.



3. Loosen the large jam nuts holding the cable to the mount bracket. Move the cable in or out. Retighten the jam nuts.

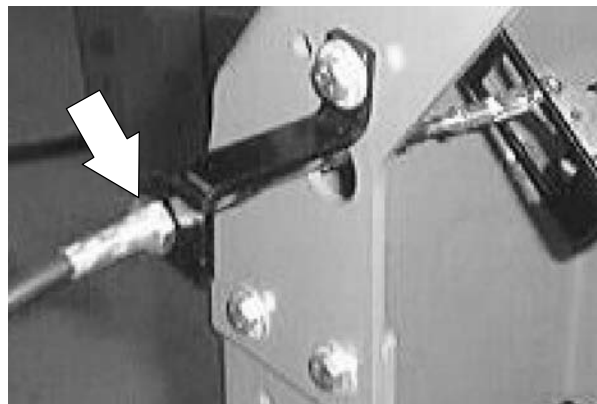

SCRUBBING

SQUEEGEES

The 8300 is equipped with two side squeegees and one rear squeegee. The rear squeegee comes in two different widths (Maxpro™ 1000 and 1200). The squeegee assemblies have replaceable rubber blades.

SIDE SQUEEGEES

The side squeegees control water spray and channel water into the path of the rear squeegee. Check the side squeegees for damage and wear daily. Replace the side squeegee blades whenever they become damaged or lose their shape or resiliency. Replace the squeegee deflectors whenever they become worn.

TO REPLACE SIDE SQUEEGEES

FOR SAFETY: Before Leaving Or Servicing Machine; Stop On Level Surface, Set Parking Brake.

1. Remove the hair pin and clevis pin from the side squeegee protection tip.

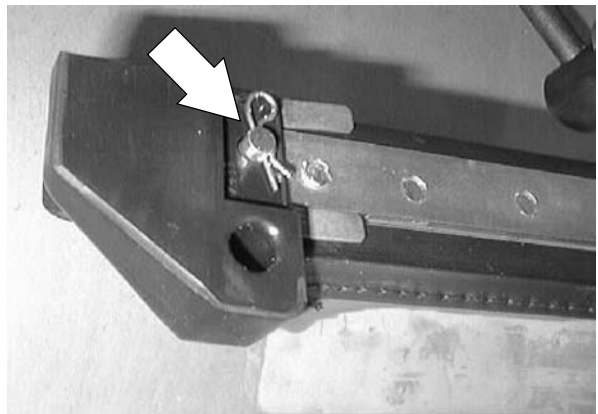
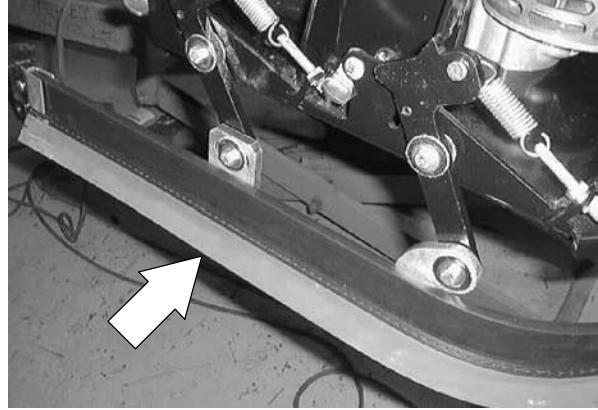

2. Remove the plastic tip and metal retainer.

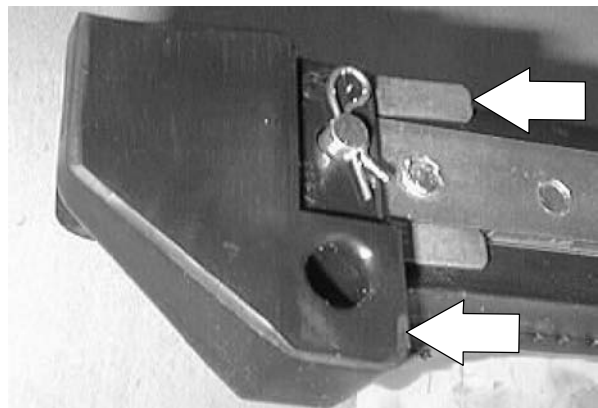

3. Remove the squeegee blade from the squeegee frame.

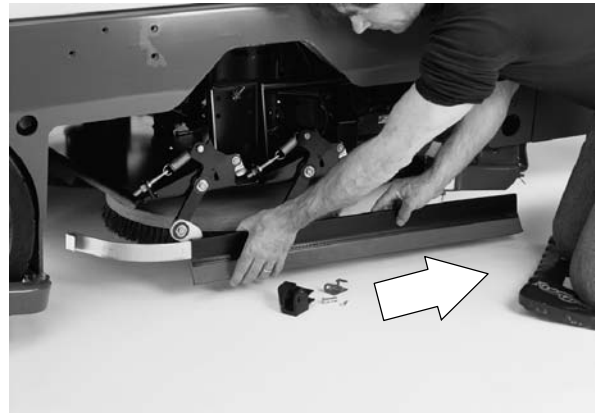

4. Install a new side squeegee blade onto the frame.

NOTE: Place a few drops of oil on the edge of the squeegee frame before installing the new blade. The new blade will slip on with less resistance.

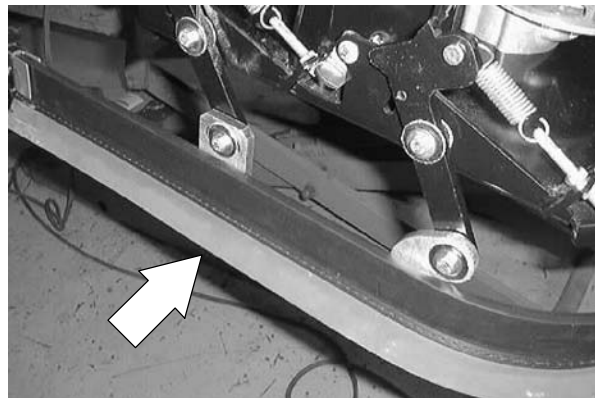

5. Reinstall the metal retainer and plastic tip.

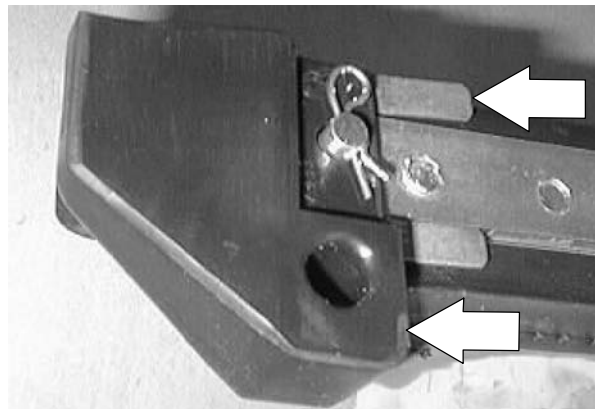

6. Reinstall the clevis pin and hair pin.

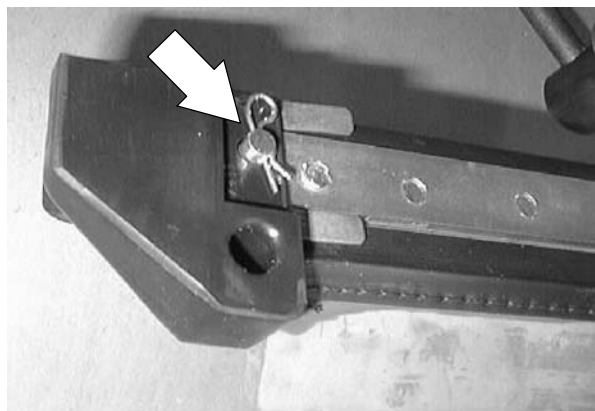

7. Operate the machine and check the side squeegee for proper operation.

SCRUBBING

TO ADJUST SIDE SQUEEGEES

FOR SAFETY: Before Leaving Or Servicing Machine; Stop On Level Surface, Set Parking Brake.

1. The side squeegees are adjusted at the factory and **should not need** further adjusting.

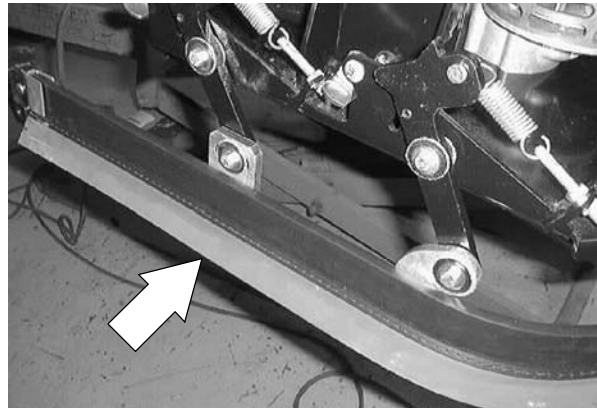

2. If the side squeegees need to have the down pressure adjusted--loosen the jam nuts on the tension spring threaded rod. Move the threaded rod down to increase tension on the spring. Retighten the jam nuts.

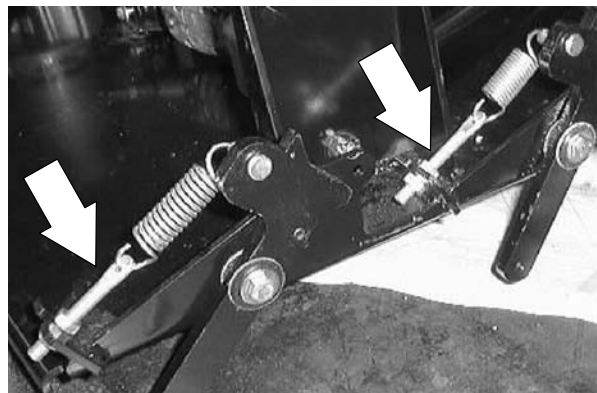

SIDE SQUEEGEE DOUBLE SCRUB CLIPS

The side squeegees can be raised and held in place for double scrubbing a dirty floor.

TO ENGAGE DOUBLE SCRUB CLIPS

1. Pull the side squeegee up front and back. Flip the double scrub clip over so it engages the notch in the squeegee arm. The squeegee will stay in the up position until the clips are moved back.

NOTE: The clips can also be used when changing the scrub brushes.

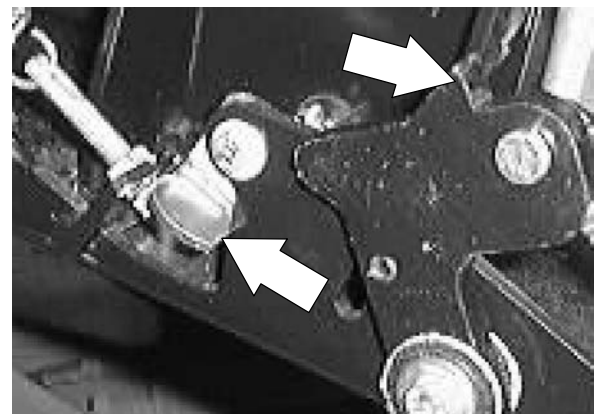

REAR SQUEEGEE

The rear squeegee assembly channels water into the vacuum fan suction. The front squeegee blade channels the water, and rear blade wipes the floor. Check the rear squeegee assembly for damage, wear, and adjustment daily.

Rotate or replace either squeegee blade if its leading edge is torn or worn half-way through the thickness of the blade.

Each blade has four wiping edges. To use them all, start with one wiping edge. To use the next wiping edge, rotate the squeegee end-for-end. To use the next wiping edge, rotate the top edges down, bottom edges up. To use the last edge, rotate the squeegee end-for-end.

TO REPLACE OR ROTATE REAR SQUEEGEE BLADES

FOR SAFETY: Before Leaving Or Servicing Machine; Stop On Level Surface, Set Parking Brake.

1. Make sure the rear squeegee is in the raised position. Pull the vacuum hose out of the squeegee frame.

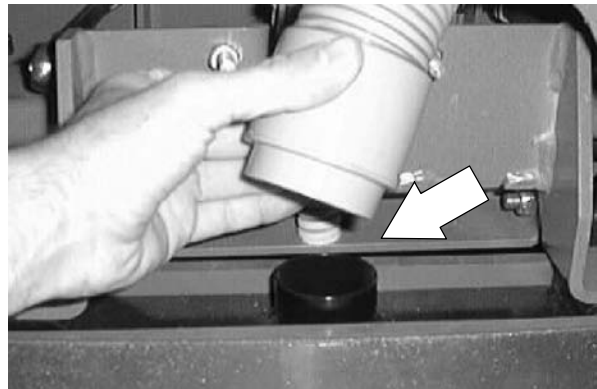

2. Loosen the hardware holding the squeegee frame to the lift assembly. Pull the squeegee frame and blade assembly off the machine.

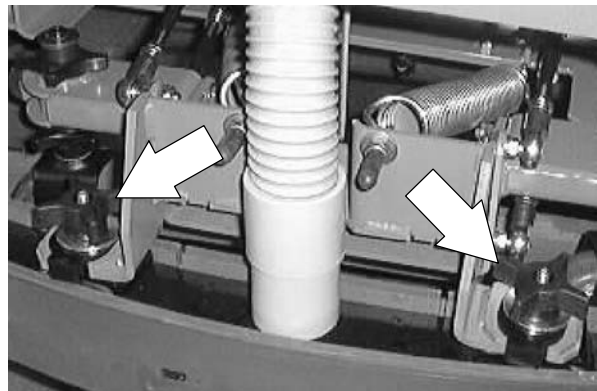

SCRUBBING

3. Flip the squeegee band lock open. Remove the band from the squeegee frame.



4. Pull the rubber squeegee blade off the frame. Rotate the blade to one of the four edges or discard blade.



5. Install the new or rotated blade onto the squeegee frame.

NOTE: Make sure the slots in the blade match up with the tangs on the frame.

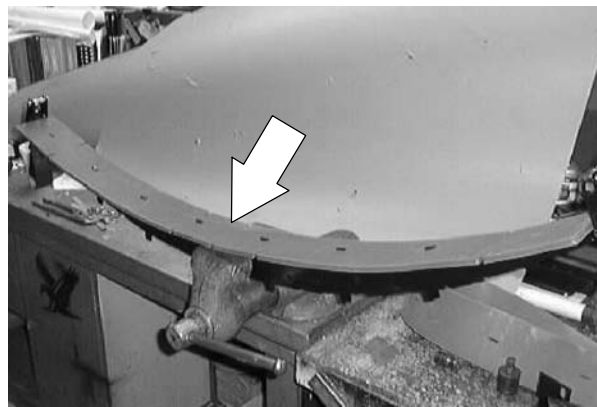

6. Reinstall the squeegee band.

NOTE: Make sure the slots in the band match up with the tangs on the frame.

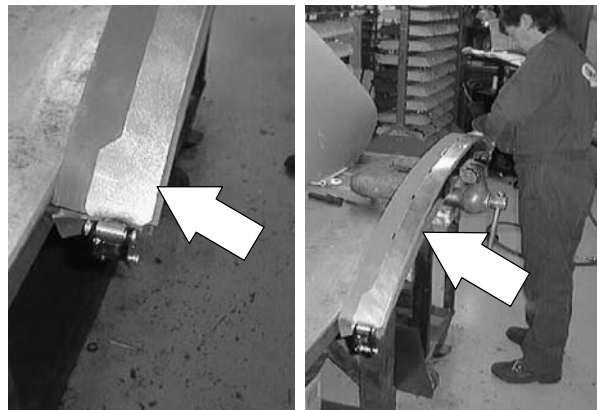

7. Flip the squeegee band lock into place and snap down to lock.

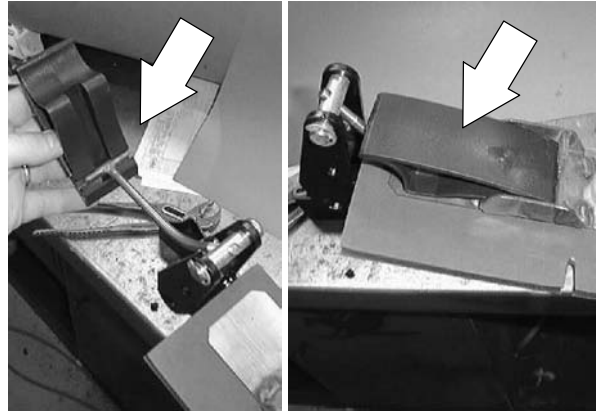

8. Repeat this procedure for the front and rear blades.

SCRUBBING

TO ADJUST REAR SQUEEGEE DEFLECTION

1. Start the machine and lower the squeegee while driving forward. Shut off the machine with the squeegee in the lowered position. **Make sure the floor is flat and level.**

FOR SAFETY: Before Leaving Or Servicing Machine; Stop On Level Surface, Set Parking Brake.

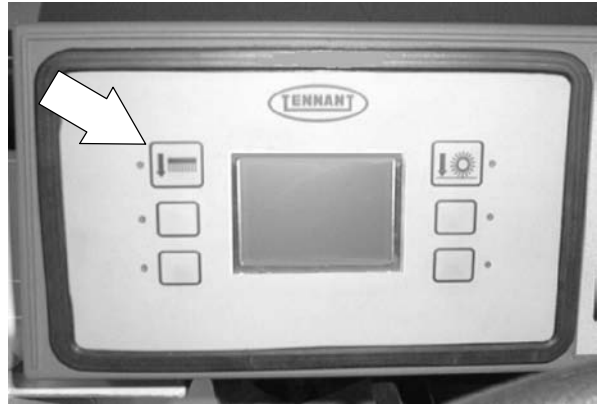

2. Check the squeegee for even deflection (*curl of squeegee blade on floor*) across the entire length of the blades. **The rear blade should deflect .50 to .75 in (13 - 20mm).**

3. If the squeegee deflection is not even side to side--go to the next step.

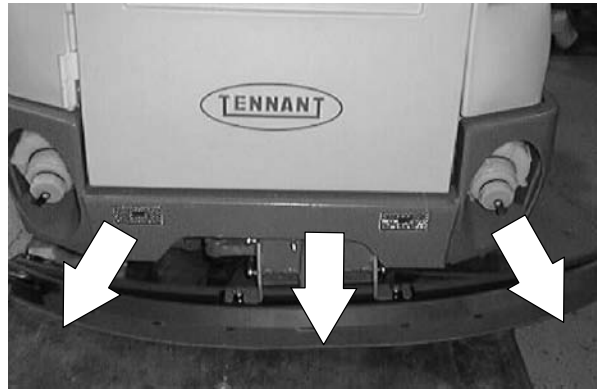

4. Loosen the large plastic jam nut located just above the squeegee caster on the side of the squeegee that needs adjusting.

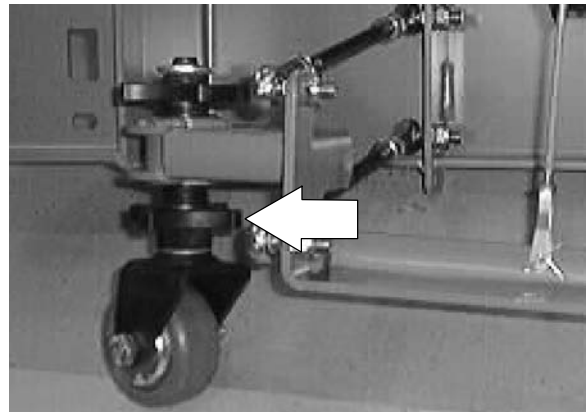

5. Turn the top of the squeegee caster assembly (*clockwise-raise squeegee counterclockwise-lower squeegee*).

6. Recheck the deflection of the squeegee. If squeegee deflection is even across the entire length of the blades--tighten the jam nut. If needed--repeat the previous step.

7. Operate the machine and check the rear squeegee for proper operation.

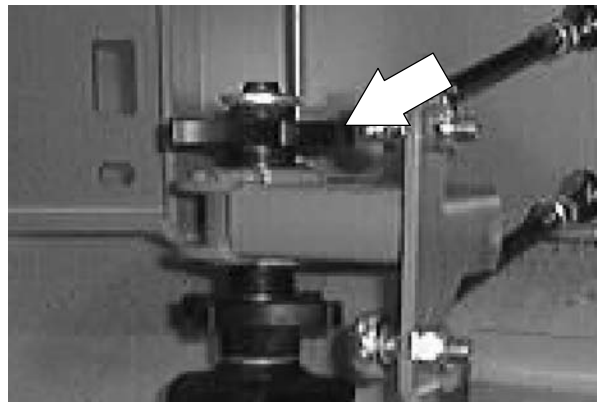

TO LEVEL REAR SQUEEGEE

1. Start the machine and lower the squeegee while driving forward. Shut off the machine with the squeegee in the lowered position. **Make sure the floor is flat and level.**

FOR SAFETY: Before Leaving Or Servicing Machine; Stop On Level Surface, Set Parking Brake.



2. Check the squeegee for levelness at each end of the blades. The front and back blades should touch the floor evenly. If either the squeegee tips are pointing up or the center of the squeegee is up slightly--go to the next step.



3. Pull the squeegee vacuum hose out of the squeegee frame. Move the hose to the side.

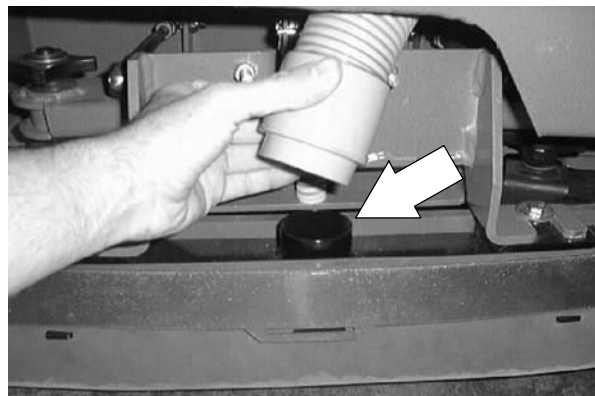

4. Turn the hex screw in the center of the squeegee mount bracket to adjust the tips up or down.

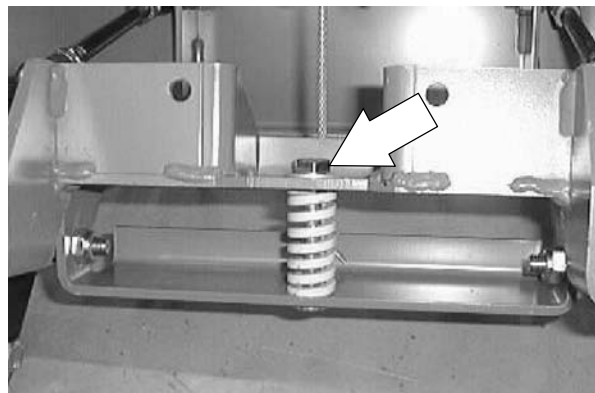

5. Recheck the levelness of the squeegee. If the squeegee blade is even across the entire length--tighten the jam nut. If needed--repeat the previous step.
6. Operate the machine and check the rear squeegee for proper operation.

SCRUBBING

TO REPLACE REAR SQUEEGEE LIFT CABLE

1. Start the machine and lower the squeegee. Shut off the machine with the squeegee in the lowered position.

FOR SAFETY: Before Leaving Or Servicing Machine; Stop On Level Surface, Set Parking Brake.



2. Remove the cotter pin and clevis pin from the squeegee lift cable where it attaches to the squeegee frame.

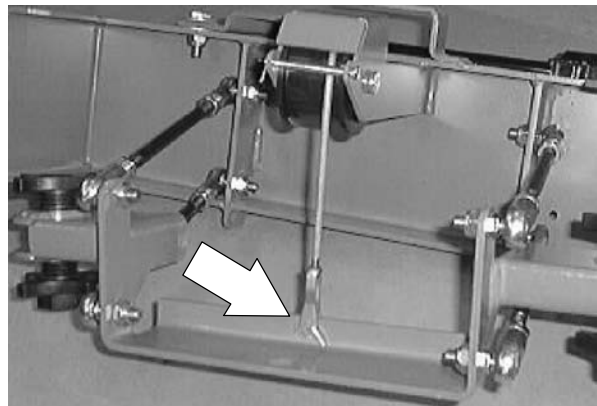

3. Remove the cotter pin and clevis pin from the squeegee lift cable where it attaches to the actuator lift pivot bracket.

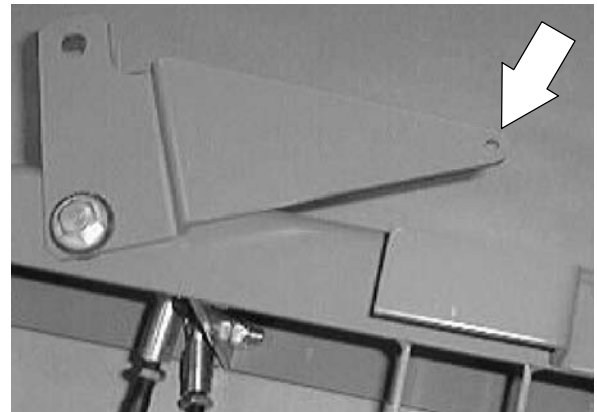

4. Remove the cotter pin from the long clevis pin in front of the squeegee lift cable roller. Remove the clevis and the lift cable from the machine.

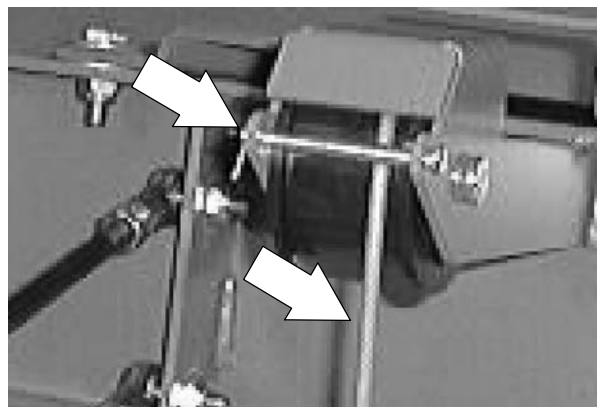

5. Position the new squeegee lift cable over the cable roller.

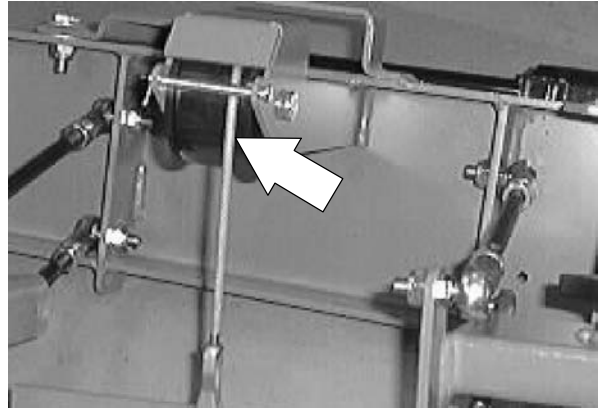

6. Reinstall the clevis pin and cotter pin in front of the lift roller.

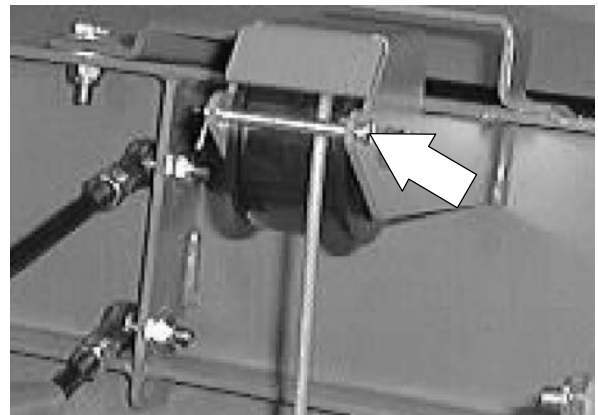

7. Reattach the squeegee lift cable to the actuator pivot bracket using the clevis pin and cotter pin.



8. Reattach the squeegee lift cable to the actuator squeegee lift bracket using the clevis pin and cotter pin.

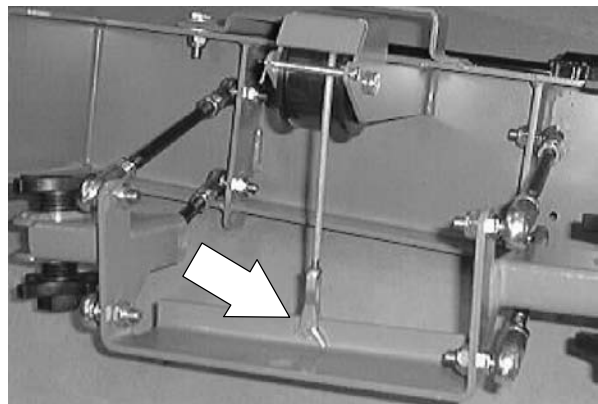

9. Operate the machine. Check the rear squeegee for proper operation.

SCRUBBING

TO REMOVE REAR SQUEEGEE ASSEMBLY

FOR SAFETY: Before Leaving Or Servicing Machine; Stop On Level Surface, Set Parking Brake.

1. Make sure the rear squeegee is in the raised position. Pull the vacuum hose out of the squeegee frame.

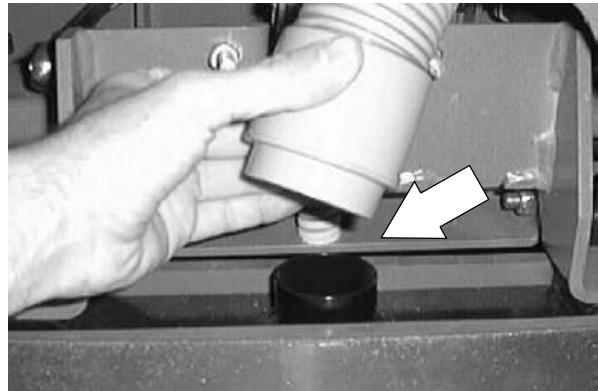

2. Loosen the hardware holding the squeegee frame to the lift assembly. Pull the squeegee frame and blade assembly off the machine.

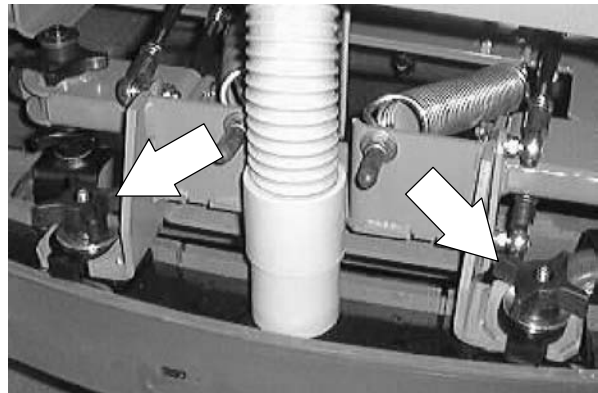

3. Remove the four hex screws holding the rear squeegee assembly to the machine frame.

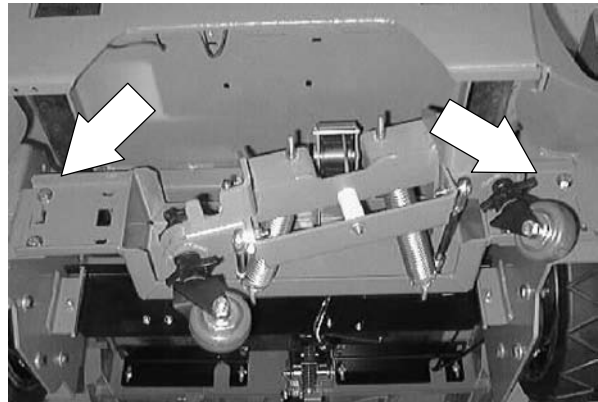

4. Pull the squeegee assembly away from the rear of the machine.

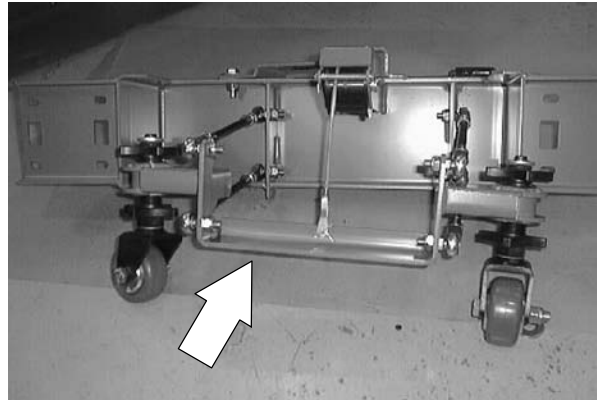

5. Disconnect the squeegee lift actuator from the main harness. The squeegee assembly can now be removed from the machine.

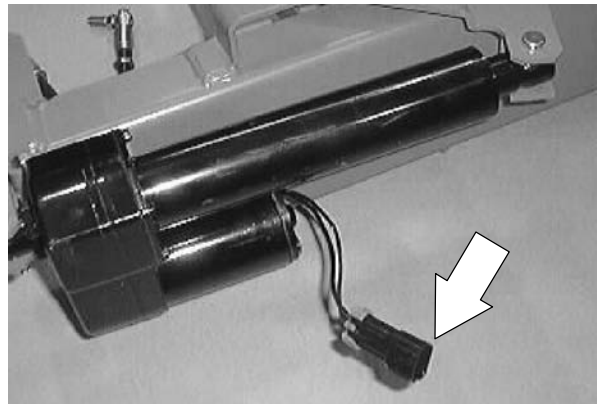

SCRUBBING

TO INSTALL REAR SQUEEGEE ASSEMBLY

1. Position the squeegee assembly at the back of the machine. Reconnect the squeegee lift actuator to the main harness.

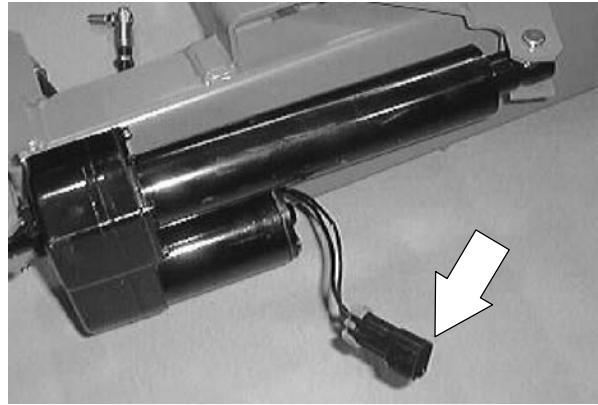

2. Position the squeegee assembly onto the back of the machine frame.

MAXPRO™ 1000: Use the left hand bolt pattern.

MAXPRO™ 1200: Use the right hand bolt pattern.

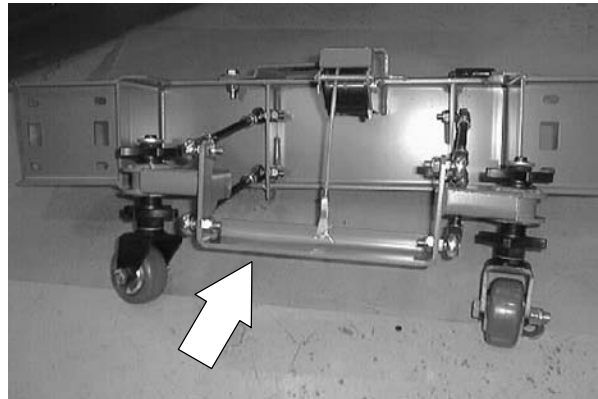

3. Reinstall the hardware. Tighten to 37 - 48 Nm (26 - 34 ft lb).

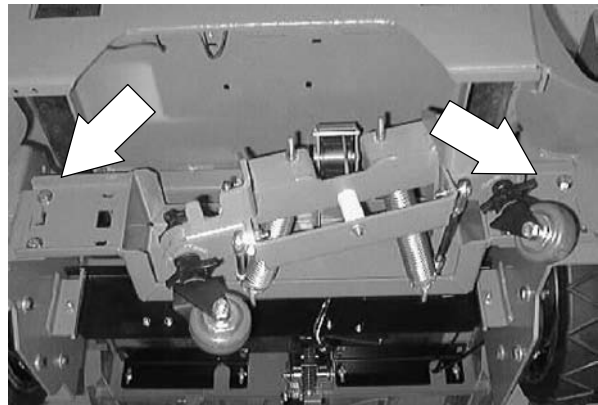

4. Reinstall the squeegee blade assembly frame onto the lift bracket. Position the vacuum hose into the hole in the squeegee frame.

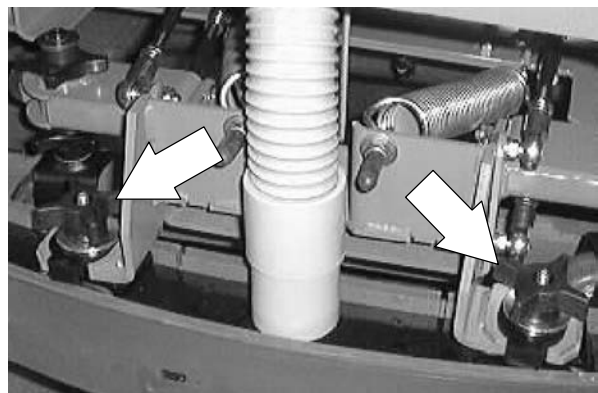

5. Operate the machine and check the squeegee assembly for proper operation.

VACUUM FANS

The scrub vacuum fans, when activated, create a vacuum in the recovery tank. The recovery tank is sealed to the demister tank cover when it is the down position. Water is pulled from the rear squeegee to the demister tank through a vacuum hose.

TO REMOVE VACUUM FAN ASSEMBLY

FOR SAFETY: Before Leaving Or Servicing Machine; Stop On Level Surface, Set Parking Brake.

1. Raise the battery cover. Unplug the battery connector.

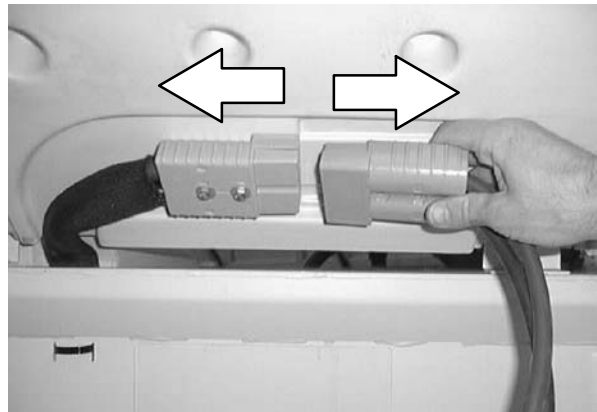

2. Open the top cover and side door.

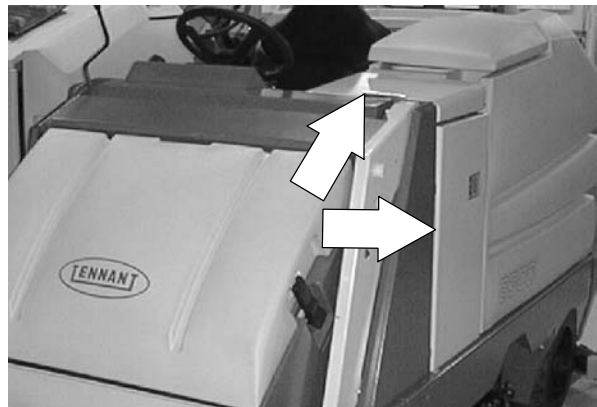

3. Disconnect the vacuum fans from the main harness.

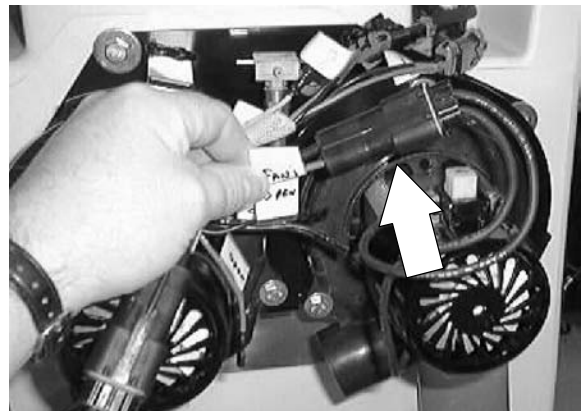

SCRUBBING

4. Disconnect the vacuum switch from the main harness.

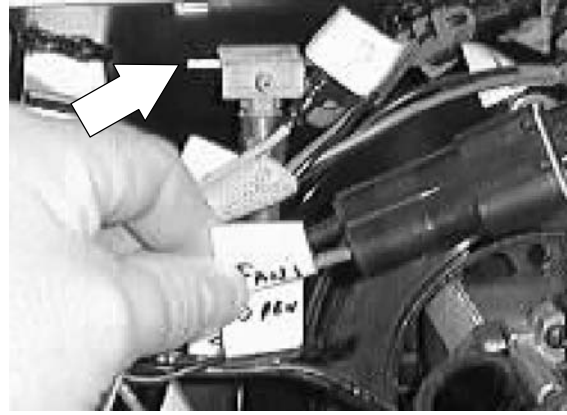

5. Remove the six M8 hex screws holding the scrub vacuum fan assembly to the front of recovery tank.



6. Remove the vacuum fan assembly from the machine.

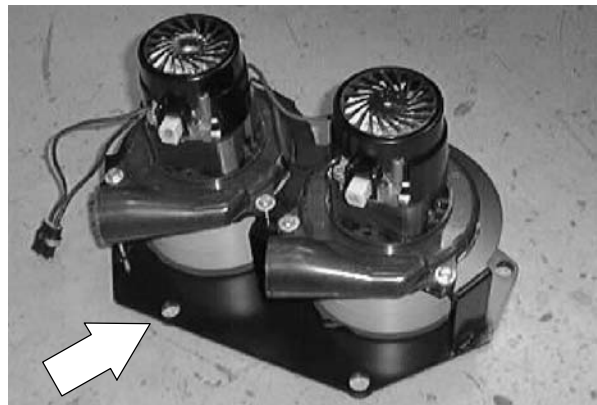

7. Check the tank gasket for rips or tears. Replace if needed.

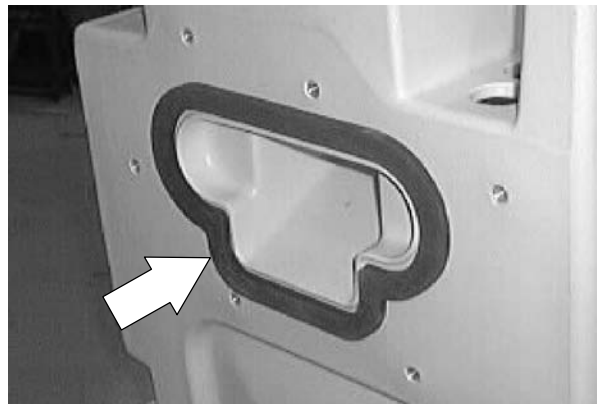

TO INSTALL VACUUM FAN ASSEMBLY

FOR SAFETY: Before Leaving Or Servicing Machine; Stop On Level Surface, Set Parking Brake.

1. Position the scrubbing vacuum fan assembly onto the front of the recovery tank. Reinstall the six M8 hex screws. Tighten to 18 - 24 Nm (15 - 20 ft lb).

NOTE: If machine is equipped with the ES/AUTO FILL option--adjust the mount bracket to the middle of the slots.



2. Reconnect the vacuum fan motors to the main harness.

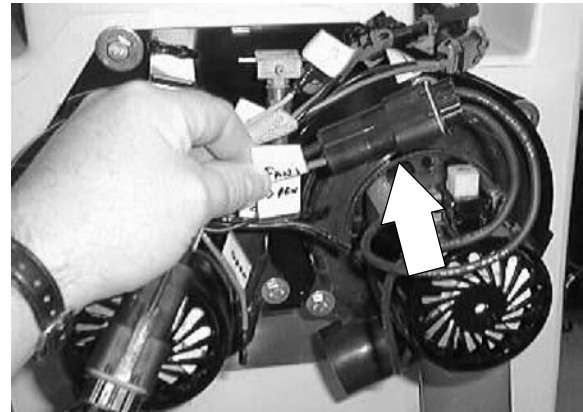

3. Reconnect the vacuum switch to the main harness.

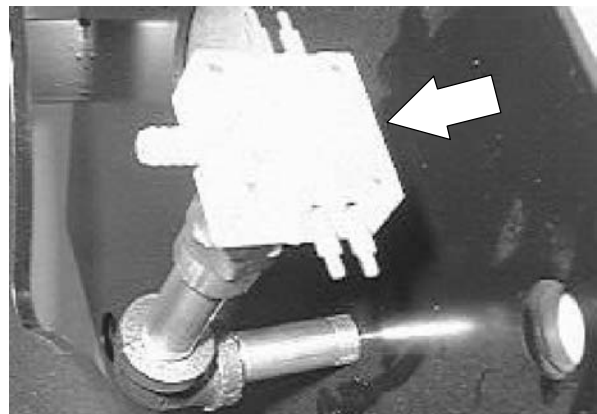

SCRUBBING

4. Plug the battery into the connector.

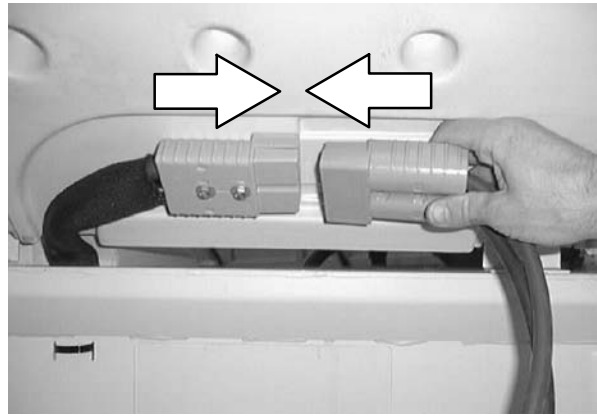

5. Close the top cover and side door.



6. Operate the machine. Check the scrubbing vacuum fans for proper operation.

TO REPLACE INDIVIDUAL VACUUM FAN

FOR SAFETY: Before Leaving Or Servicing Machine; Stop On Level Surface, Set Parking Brake.

1. Raise the battery cover. Unplug the battery connector.

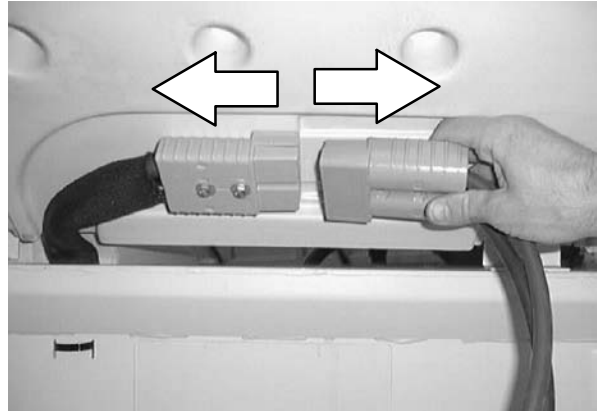

2. Open the top cover and side door.



3. Disconnect the vacuum fans from the main harness.

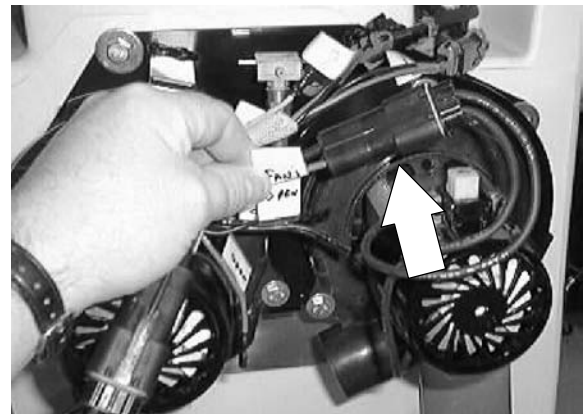

SCRUBBING

4. Remove the three M6 hex screws holding the individual vacuum fan to the mount bracket.

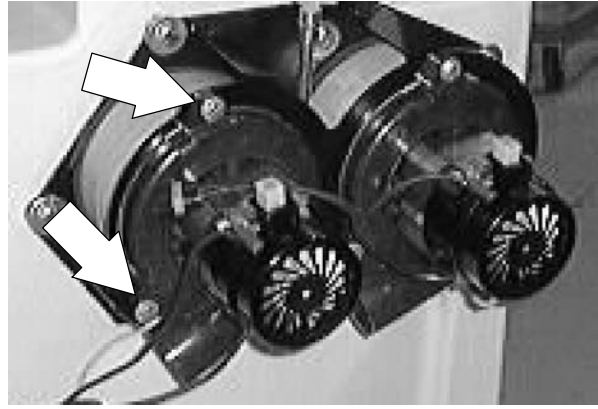

5. Remove the vacuum fan from the bracket. *Note orientation of exhaust port.*

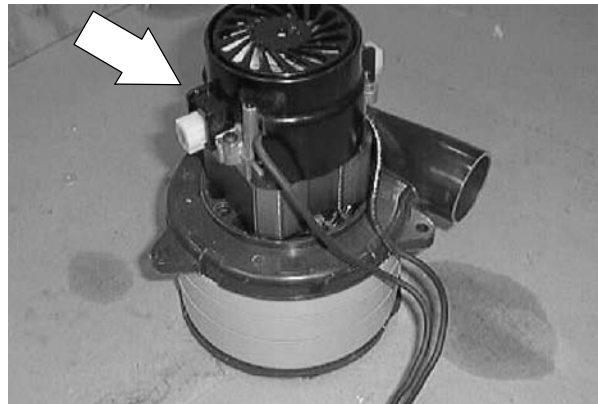

6. Check the gasket on the back of the vacuum fan for rips or tears before installing on the mount bracket.

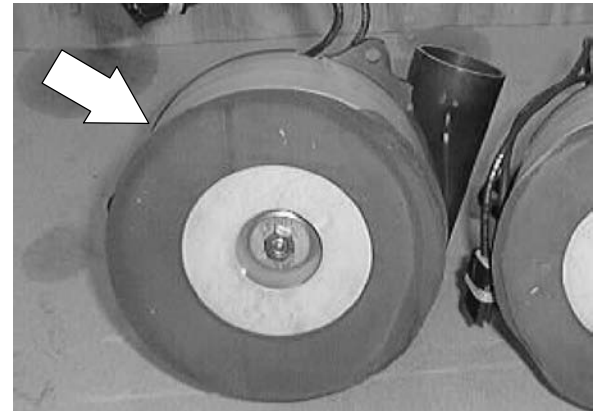

7. Position the new vacuum fan onto the fan mount bracket.

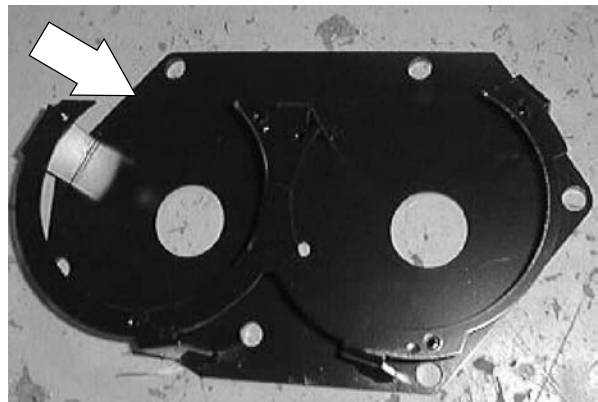

8. Reinstall the three M6 hex screws and tighten to 8 - 10 Nm (5 - 6 ft lb).
Note orientation of exhaust port.

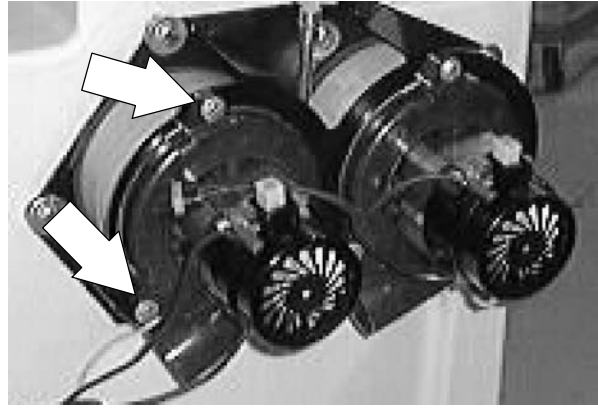

9. Reconnect the vacuum fan to the main electrical harness.

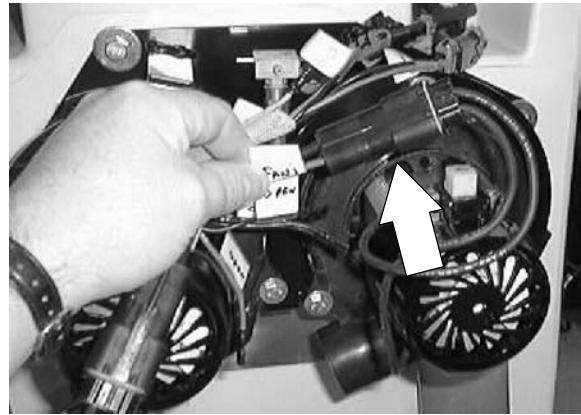

10. Plug the battery into the connector.

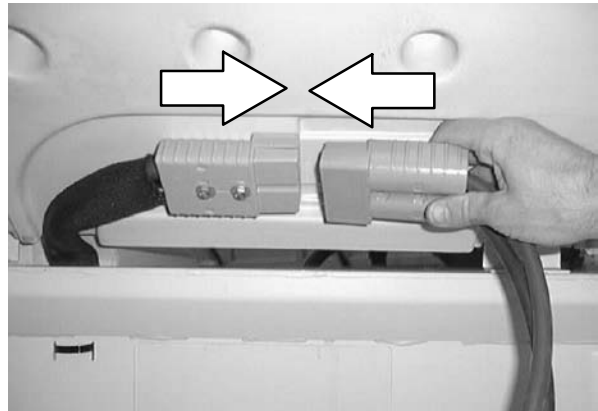

11. Close the top cover and side door.

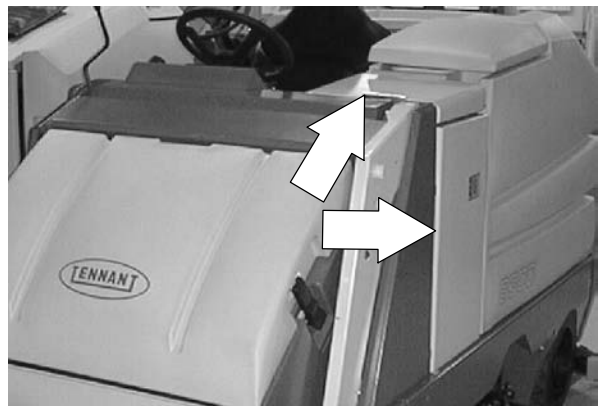

12. Operate the machine. Check the scrubbing vacuum fans for proper operation.

SCRUBBING

SCRUBBING TROUBLESHOOTING

Problem	Cause	Remedy
Trailing water – poor or no water pickup.	Worn rear squeegee blades.	Rotate or replace squeegee blades.
	Rear squeegee out of adjustment.	Adjust rear squeegee.
	Side squeegees raised.	Lower side squeegees.
	Worn side squeegee blades.	Replace side squeegee blades.
	Side squeegees out of adjustment.	Adjust side squeegees.
	Too much solution flow to floor.	Reduce solution flow to floor.
	Vacuum hose clogged.	Flush vacuum hoses.
	Recovery tank full.	Drain recovery tank.
	Float stuck shutting off vacuum.	Clean float.
	Debris caught on rear squeegee.	Remove debris.
	Foam filling recovery tank.	Empty recovery tank; use less or change detergent.
	Vacuum hose to rear squeegee disconnected or damaged.	Reconnect or replace vacuum hose.
	Vacuum fan to recovery tank hose damaged.	Replace hose.
Vacuum fan will not turn on	Recovery tank full	Drain recovery tank
	Foam filling recovery tank	Empty recovery tank
		Use less or change detergent
		Use a defoamer
	Vacuum fan circuit breaker tripped	Reset circuit breaker
Vacuum fan failure	Contact Tennant service representative	
Little or no solution flow to the floor.	Solution tank empty.	Fill solution tank.
	Solution control linkage broken or out of adjustment.	Replace and/or adjust cable.
	Solution supply lines plugged.	Flush solution supply lines.
	ES™ switch off.	Turn ES™ switch on.
Poor scrubbing performance.	Debris caught on scrub brushes.	Remove debris.
	Improper detergent or brushes used.	Check with TENNANT representative for advice.
	Worn scrub brushes.	Replace scrub brushes.
ES™ system does not fill solution tank.	Clogged solution pump or lines.	Flush ES™ system.
	ES™ float switch(es) stuck.	Clean switch floats of debris.
	Clogged ES™ filter.	Clean filter.
	Water levels too low in tanks.	Add water.

CONTENTS

	Page		Page
INTRODUCTION	5-3	WIRE HARNESSSES GROUP	5-121
BATTERIES	5-4	DIAGNOSTICS-8300	5-127
TO CHARGE BATTERIES	5-5	OPERATING MODES	5-128
CIRCUIT BREAKERS	5-8	8300 OPERATING MODES	5-129
TO REPLACE CIRCUIT BREAKER	5-9	8300 MAINTENANCE MODES ..	5-130
FUSE	5-12	INTERLOCKS	5-132
TO REPLACE PROPELLING		SCRUB BRUSH AND SOLUTION	
FUSE	5-12	FLOW VALVE OPERATION	
INSTRUMENT PANEL	5-15	ENABLED	5-132
TO REPLACE TOUCH PANEL ...	5-15	SCRUB BRUSH AND SOLUTION	
TO REPLACE SCRUBBING		FLOW VALVE OPERATION	
CIRCUIT BOARD	5-20	INHIBITED	5-132
TO REPLACE SWEEPING		SQUEEGEE AND VACUUM FAN	
CIRCUIT BOARD	5-24	OPERATION ENABLED	5-132
DIRECTIONAL PEDAL	5-28	SQUEEGEE AND VACUUM FAN	
TO REPLACE CURTIS DIRECTIONAL		OPERATION INHIBITED	5-132
CONTROL UNIT	5-29	ES™ PUMP OPERATION	
TO REPLACE TRACTION MOTOR		ENABLED	5-133
CONTROLLER	5-33	ES™ PUMP OPERATION	
TO REPLACE 36V RELAY	5-37	INHIBITED	5-133
TO REPLACE TRACTION MOTOR	5-40	SWEEP BRUSH OPERATION	
PROPEL MOTOR BREAKDOWN ...	5-45	ENABLED	5-133
TO REPLACE DISC SCRUB HEAD		SWEEP BRUSH OPERATION	
BRUSH MOTOR	5-46	INHIBITED	5-133
TO REPLACE CYLINDRICAL SCRUB		SWEEP FAN OPERATION	
HEAD BRUSH MOTOR	5-50	ENABLED	5-134
TO REPLACE SCRUB HEAD LIFT		SWEEP FAN OPERATION	
ACTUATOR	5-55	INHIBITED	5-134
TO REPLACE "FAILED" SCRUB HEAD		SIDE BRUSH OPERATION	
LIFT ACTUATOR	5-58	ENABLED	5-134
TO REPLACE REAR SQUEEGEE		SIDE BRUSH OPERATION	
LIFT ACTUATOR	5-59	INHIBITED	5-134
TO REPLACE SIDE SHIFT		SOLUTION TANK AUTOFILL	
ACTUATOR	5-63	VALVE ENABLED	5-135
ES™ PUMP	5-66	SOLUTION TANK AUTOFILL	
TO REPLACE ES™ PUMP	5-66	VALVE DISABLED	5-135
DETERGENT PUMP	5-69	RECOVERY TANK AUTOFILL	
TO REPLACE DETERGENT PUMP	5-69	VALVE ENABLED	5-135
TO REPLACE AUTO FILL VALVES	5-72	RECOVERY TANK AUTOFILL	
TO REPLACE SOLUTION		VALVE DISABLED	5-135
SOLENOID VALVE	5-76	HOPPER LIFT SOLENOID	
TO REPLACE SWEEPER VACUUM		ENABLED	5-135
FAN MOTOR	5-79	HOPPER LOWER SOLENOID	
TO REPLACE SWEEPER MAIN		ENABLED	5-135
BRUSH MOTOR	5-86	HOPPER LOWER SOLENOID	
TO REPLACE SWEEPER SIDE		DISABLED	5-135
BRUSH MOTOR	5-92	HOPPER TILT OPEN/DOWN	
TO REPLACE HOPPER ROLL OUT		ENABLED	5-136
ACTUATOR	5-95	HOPPER TILT OPEN/DOWN	
TO REPLACE SWEEPER MAIN		DISABLED	5-136
BRUSH LIFT ACTUATOR ...	5-100	HOPPER TILT CLOSED/UP	
TO REPLACE SIDE BRUSH LIFT		ENABLED	5-136
ACTUATOR	5-105	HOPPER TILT CLOSED/UP	
ELECTRICAL SCHEMATIC	5-108	DISABLED	5-136
WIRE HARNESSSES GROUP	5-112	DETERGENT PUMP ENABLED	5-136

	Page		Page
DETERGENT PUMP DISABLED	5-136	SHAKER SYSTEM TESTING ...	5-197
SHAKER SOLENOID ENABLED	5-137	HOPPER UP/DOWN TESTING .	5-200
SHAKER SOLENOID DISABLED	5-137		
ALARM CONDITIONS	5-137		
BASIC 8300 OPERATION	5-138		
EDGE SCRUB (SCRUB, SWEEP/SCRUB MODE) ..	5-138		
SQUEEGEE (SCRUB, SWEEP/ SCRUB, SWEEP MODE) .	5-138		
SCRUB (SCRUB, SWEEP/SCRUB, SWEEP MODE)	5-138		
DETERGENT (SCRUB MODE)	5-140		
ES™ (SCRUB MODE)	5-140		
OVERFLOW (SCRUB MODE, SWEEP/SCRUB MODE) ..	5-140		
MAIN SWEEP BRUSH (SWEEP MODE, SWEEP/SCRUB MODE)	5-141		
SIDE SWEEP BRUSH (SWEEP MODE, SWEEP/SCRUB MODE) ..	5-141		
HOPPER UP/DOWN	5-141		
HOPPER TILT DOWN	5-142		
HOPPER TILT UP	5-142		
FILTER SHAKER	5-143		
VACUUM FAN	5-143		
MAINTENANCE MODES	5-144		
MANUAL MODE	5-145		
INPUT DISPLAY MODE	5-148		
SELF TEST MODE	5-149		
SET CLOCK	5-150		
CHECK MAINTENANCE MODE .	5-151		
SCRUB CIRCUIT BOARD PIN FUNCTIONS	5-152		
SWEEP CIRCUIT BOARD PIN FUNCTIONS	5-153		
POWER UP TESTING	5-154		
SCRUB VACUUM FAN TESTING	5-156		
TOUCH PANEL AND RIBBON CABLE TESTING	5-158		
PROPEL TESTING	5-161		
SCRUB TESTING	5-164		
SQUEEGEE TESTING	5-170		
WATER VALVE TESTING	5-173		
OPEN/CLOGGED SCRUB VAC SWITCH TESTING	5-176		
OPEN/CLOGGED SCRUB VAC SWITCH TESTING	5-177		
ES™ SYSTEM OPERATION AND TESTING	5-178		
DETERGENT METERING SYSTEM TESTING	5-180		
AUTO FILL SYSTEM TESTING .	5-183		
POWER STEERING TESTING ..	5-186		
SWEEP BRUSH SYSTEM TESTING	5-188		
SWEEPER VACUUM ACTIVATION	5-191		
SWEEP SIDE BRUSH SYSTEM TESTING	5-194		

INTRODUCTION

The 8300 electrical system consists of the batteries, instrument panel, control panels, traction motor, actuators, pumps, switches, relays, circuit board, and circuit breakers.

BATTERIES

The batteries are unique in that they hold their power for long periods of time. The lifetime of the batteries is limited by the number of charges the batteries receive. To get the most life from the batteries, charge them when all the battery discharge indicator segments shut off (20% charge left). Use an automatic charger with the proper rating for the batteries.

Periodically clean the top surface of the batteries and terminals with a strong solution of baking soda and water. Brush the solution sparingly over the battery tops, terminals, and cable clamps. Do not allow any baking soda solution to enter the batteries. Use a wire brush to clean the terminal posts and the cable connectors. After cleaning, apply a coating of clear battery post protectant to the terminals and the cable connectors. Check the batteries for loose connections. Keep the tops of the batteries clean and dry.

Keep all metallic objects off the top of the batteries, which may cause a short circuit. Replace any worn or damaged wires.

Check the electrolyte level in each battery cell before and after charging, and after every 50 hours of operation. Do not charge the batteries unless the fluid is slightly above the battery plates. If needed, add just enough distilled water to cover the plates. Never add acid to the batteries. Do not overfill. Always keep the battery caps on, except when adding water or taking hydrometer readings.

Measuring the specific gravity, using a hydrometer, is a way to determine the charge level and condition of the batteries. If one or more of the battery cells test lower than the other battery cells (0.050 or more), the cell is damaged, shorted, or is about to fail.

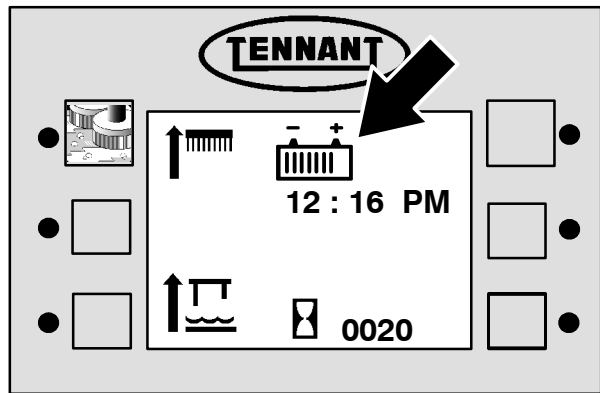

353550

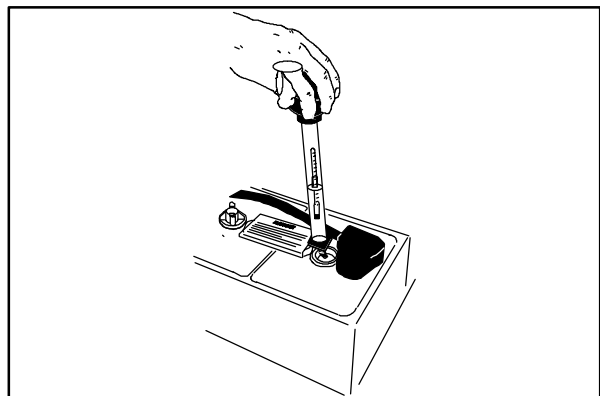
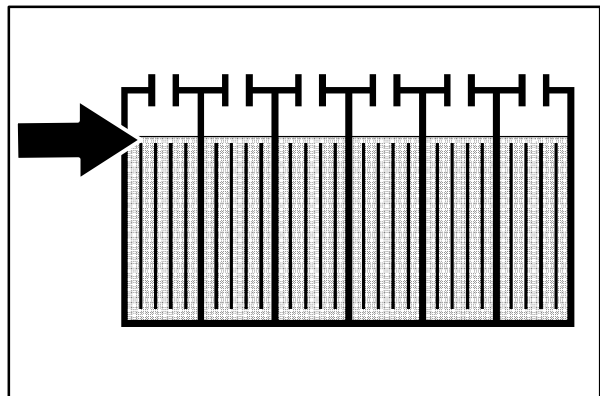

04380

NOTE: Do not take readings immediately after adding distilled water. If the water and acid are not thoroughly mixed, the readings may not be accurate. Check the hydrometer readings against the following chart to determine the remaining battery charge level:

SPECIFIC GRAVITY at 27° C (80° F)	BATTERY CHARGE
1.290	100% Charged
1.252	75% Charged
1.200	50% Charged
1.177	25% Charged
1.140	Discharged

NOTE: If the readings are taken when the battery electrolyte is any temperature other than 27° C (80° F), the reading must be temperature corrected. Add or subtract to the specific gravity reading 0.004, 4 points, for each 6° C (10° F) above or below 27° C (80° F).

TO CHARGE BATTERIES

1. Drive the machine to a flat, dry surface in a well-ventilated area.
2. Turn the machine power off and set the parking brake.

FOR SAFETY: Before leaving or servicing machine; stop on level surface, turn off machine.

3. Open the top battery compartment cover. The support arm will engage when the cover is lifted all the way up.

⚠ WARNING: Batteries emit hydrogen gas. Explosion or fire can result. Keep sparks and open flame away. Keep covers open when charging.

4. Open the rear battery compartment door.

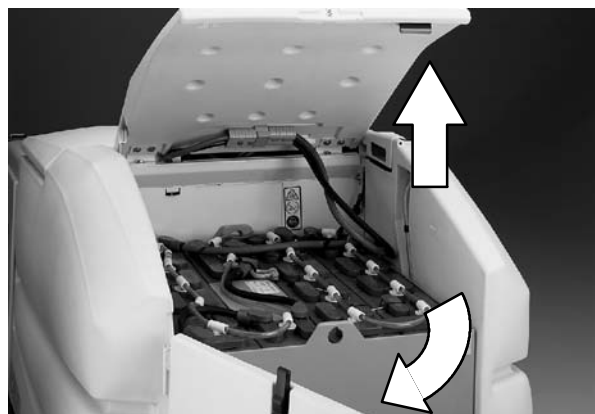

ELECTRICAL

5. Check the electrolyte level in all the battery cells.

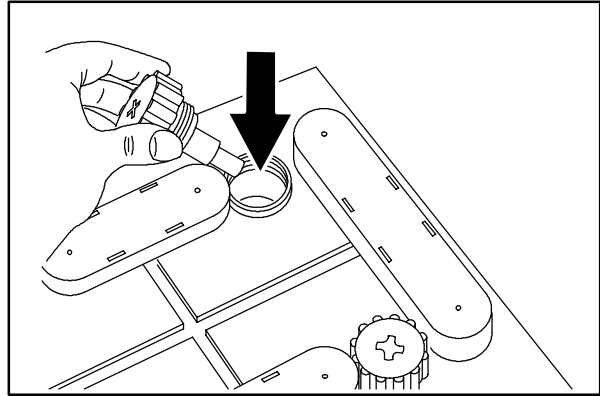

08247

6. If the level is low, add just enough distilled water to cover the battery plates. DO NOT OVERFILL. The batteries can overflow during charging due to expansion.

NOTE: Make sure the battery caps are in place while charging.

FOR SAFETY: When maintaining or servicing machine, avoid contact with battery acid.

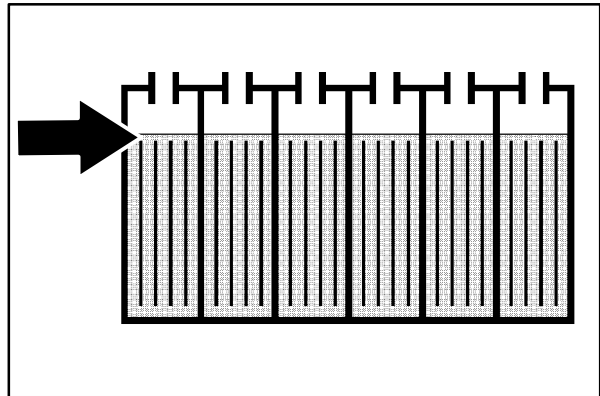

7. Unplug the battery connector from the machine connector.
8. Plug the charger connector into the battery connector.
9. Plug the battery charger into the wall outlet.

NOTE: If the red "ABNORMAL CYCLE" lamp lights when the TENNANT charger is plugged into a wall outlet, the charger can not charge the battery and there is something wrong with the battery.

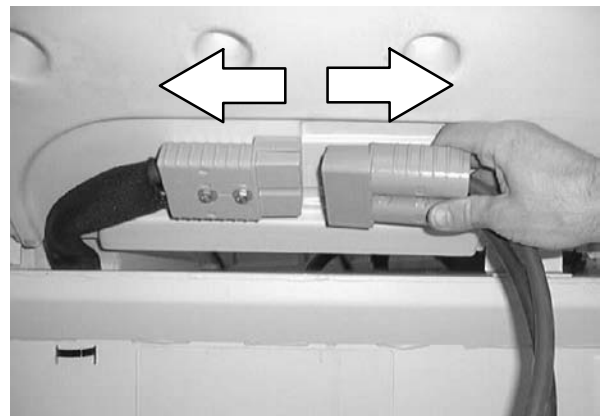

10. The Tennant charger will start automatically. When the batteries are fully charged, the Tennant charger will automatically turn off.

NOTE: Use a charger with the proper rating for the batteries to prevent damage to the batteries or reduce the battery life.

NOTE: If the charger needs to be disconnected from the machine before the batteries are fully charged and the charger has not automatically shut off, turn off the charger before disconnecting it.

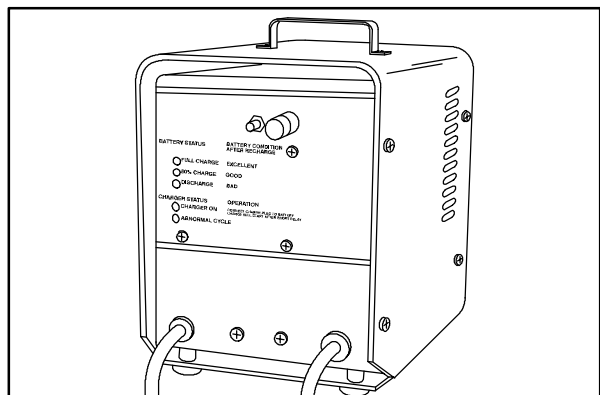

07224

11. After the charger has turned off, unplug the charger from the wall outlet.
12. Unplug the charger connector from the battery connector on the machine.
13. Reconnect the battery connector to the machine connector.

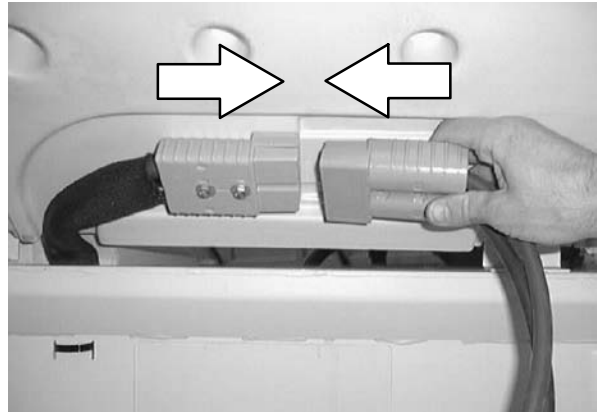

14. Check the electrolyte level in each battery cell before and after charging. If needed, add distilled water to raise the electrolyte level to about 12mm (0.4in) below the bottom of the sight tubes.

FOR SAFETY: When maintaining or servicing machine, avoid contact with battery acid.

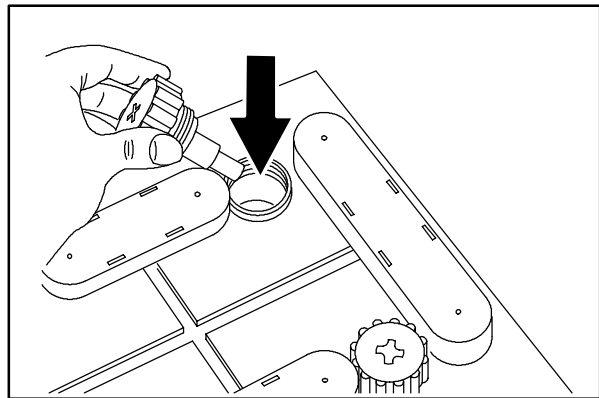

08247

15. Close the rear battery compartment door. Disengage the support arm, and close the top battery compartment cover.

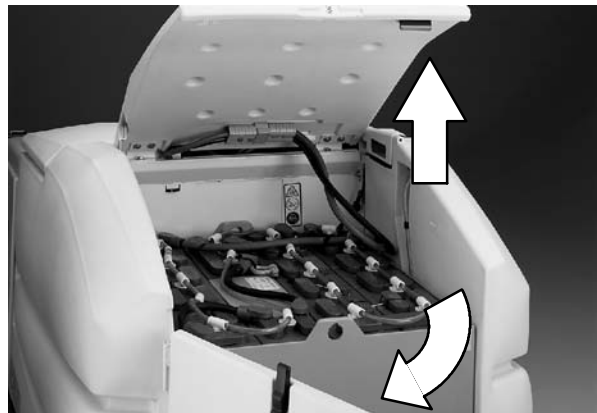

CIRCUIT BREAKERS

The circuit breakers are resettable electrical circuit protection devices. They stop the flow of current in the event of a circuit overload. Once a circuit breaker is tripped, reset it manually by pressing the reset button after the breaker has cooled down.

If the overload that caused the circuit breaker to trip is still there, the circuit breaker will continue to stop current flow until the problem is corrected.

The fuse is a one-time circuit protection device designed to stop the flow of current in the event of a circuit overload. Never substitute higher value fuses than those specified in this manual.

The circuit breakers are located to the left of the operator's compartment and in the control box. The fuses are also located in the control box.

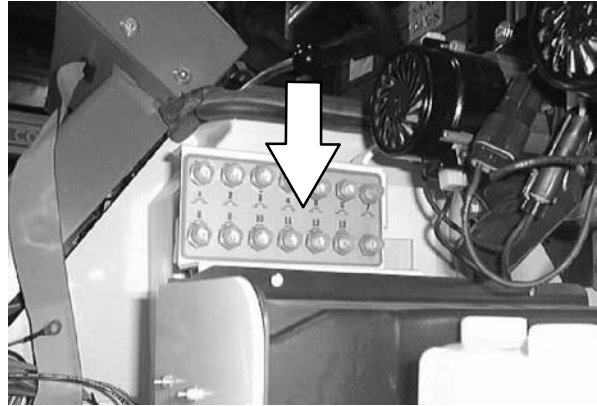

The chart below shows the circuit breakers and fuses, and the electrical components they protect.

Circuit Breaker	Rating	Circuit Protected
CB1	15 A	Sweeper/Hopper Controls
CB2	20 A	Sweeper Vacuum Fan Motor
CB3	30 A	Sweeper Brush Motor
CB4	15 A	Filter Shaker/Sweeper Side brushes/ Power Wand
CB5	10 A	Key Switch
CB6	40/50 A	Right Scrub Motor
CB7	40/50 A	Left Scrub Motor
CB8	15 A	Lights
CB9	15 A	Horn
CB10	20 A	Scrub Vac Fan #1
CB11	20 A	Scrub Vac Fan #2
CB12	25 A	Control Board
CB13	40 A	Center Scrub Motor
CB14	40 A	Power Steering Pump

TO REPLACE CIRCUIT BREAKER

FOR SAFETY: Before Leaving Or Servicing Machine; Stop On Level Surface, Set Parking Brake.

1. Raise the rear cover and unplug the battery connector.

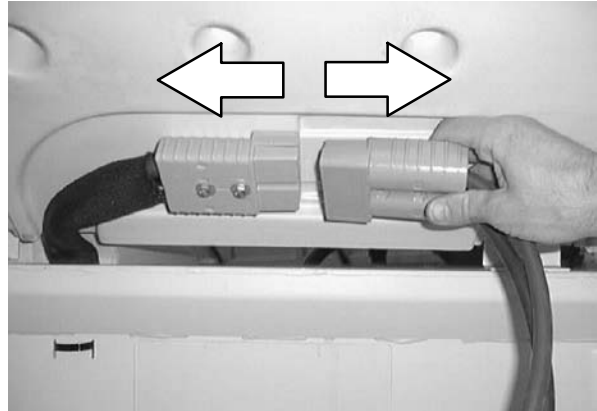

2. Open the top cover and side door.



3. Remove the plastic traction motor cover.



ELECTRICAL

4. Locate the circuit breaker panel on the left side of the operators compartment, in front of the scrub vacuum fans.

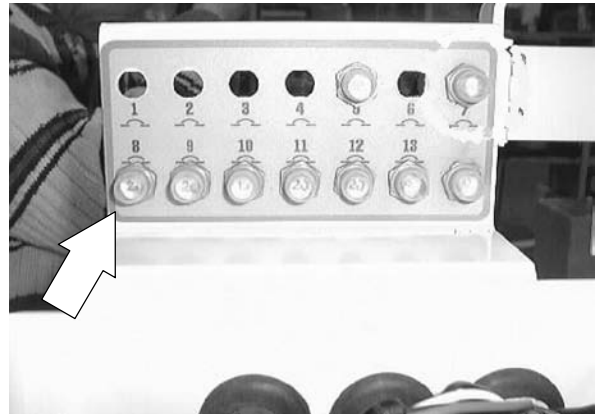

5. Mark and disconnect the wire leading to the circuit breaker that needs to be changed.

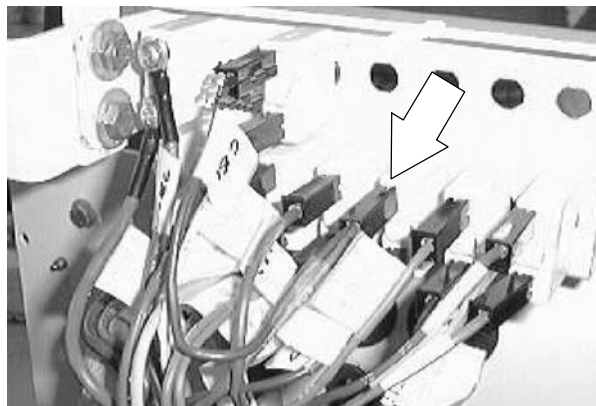

6. Remove the rubber boot from the outside of the circuit breaker. Remove the circuit breaker from the machine.

7. Install the new circuit breaker (*with the same amp rating*) into the mount hole. Reinstall the rubber boot and hand tighten.

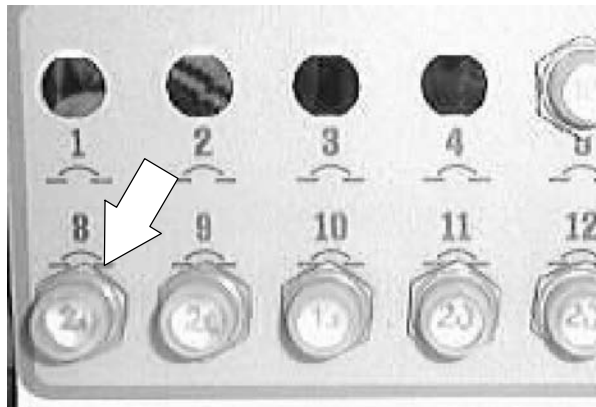

8. Reconnect the wires to the back of the new circuit breaker.

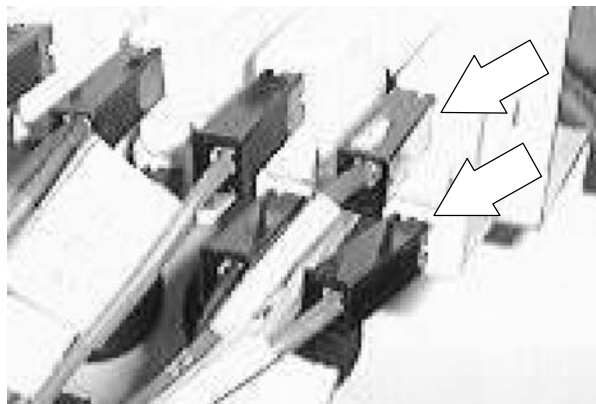

9. Reinstall the plastic traction motor cover.



10. Close the top cover and side door.

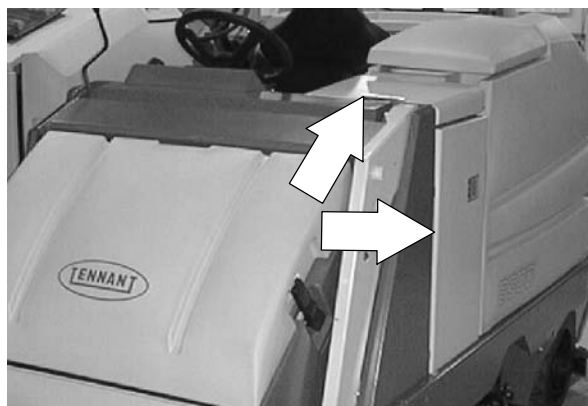

11. Plug the battery connector into the machine.
Close the rear cover.

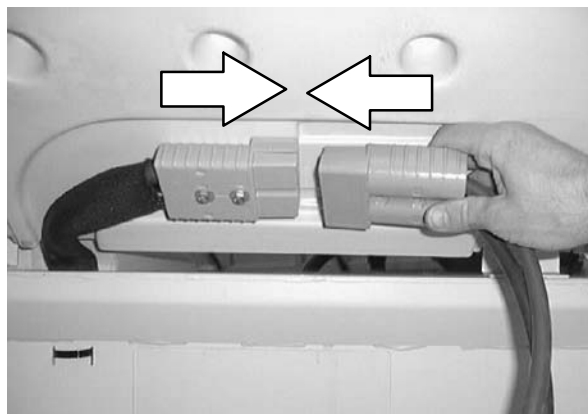

12. Operate the machine. Check the new circuit breaker for proper operation.

ELECTRICAL

FUSE

Fuses are a one-time protection device designed to stop the flow of current in the event of a circuit overload. Never substitute higher value fuses than specified.

The fuses are located near the main control box.

Fuse	Rating	Circuit Protected
FU 1	200 A	Propelling
FU 2	10 A	Electronic Actuator
FU 3	10 A	Electronic Actuator



TO REPLACE PROPELLING FUSE

FOR SAFETY: Before Leaving Or Servicing Machine; Stop On Level Surface, Set Parking Brake.

1. Raise the rear cover and unplug the battery connector.

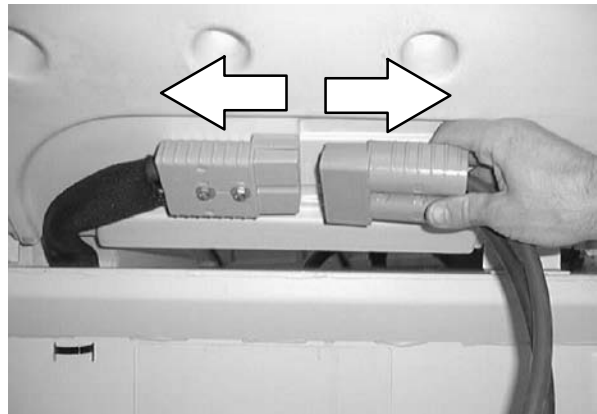

2. Open the top cover and side door.

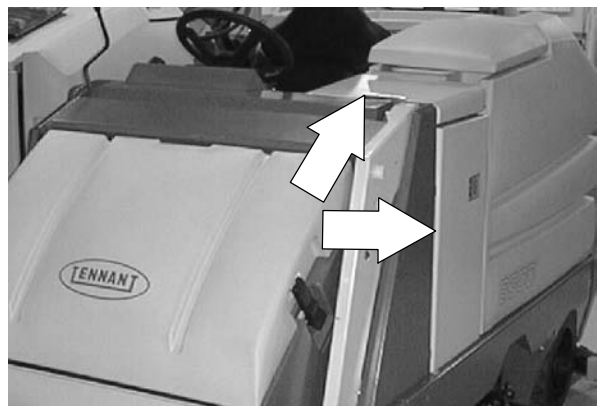

3. Remove the detergent tank and control panel cover from the machine.

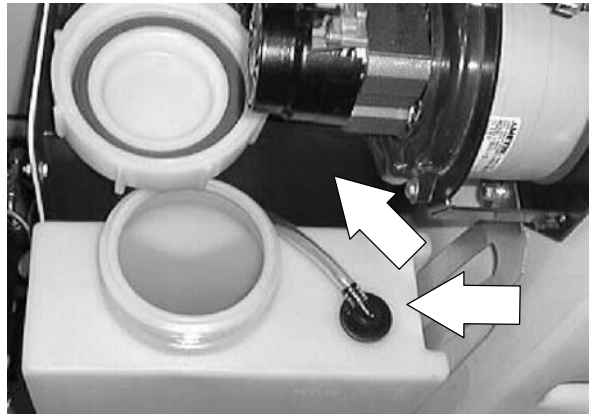

4. Locate the propelling fuse in the control box

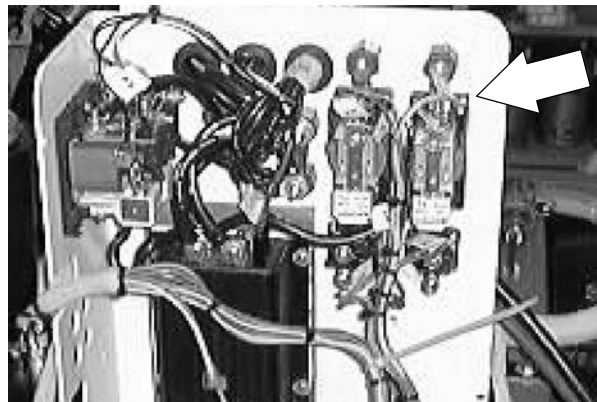

5. Loosen the two hex screws holding the propelling fuse to the cable standoffs.

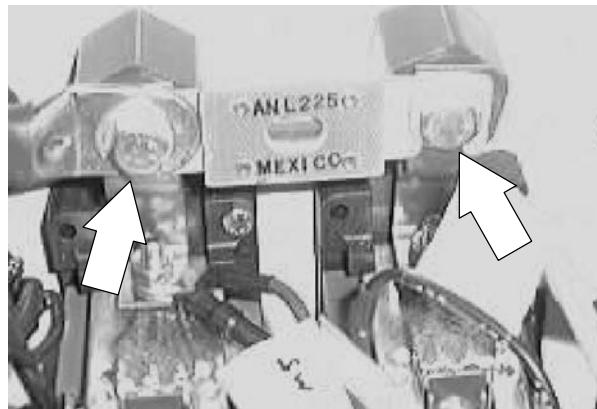

6. Pull one end of the fuse up, then remove the fuse from the standoff.

7. Install the new propelling fuse in the same orientation. Hand tighten the two hex screws tight.



ELECTRICAL

8. Reinstall the control panel cover and detergent tank onto the machine.

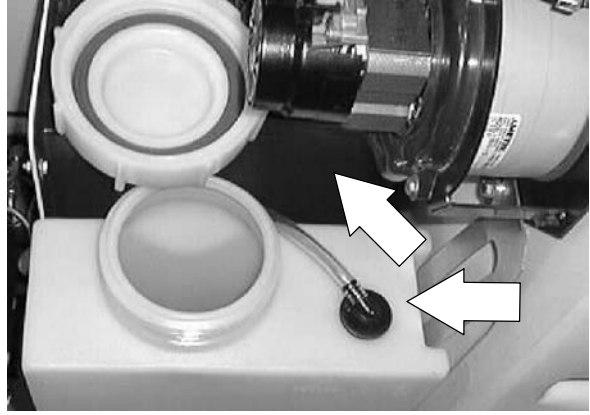

9. Close the top cover and side door.



10. Plug the battery connector into the machine.
Close the rear cover.

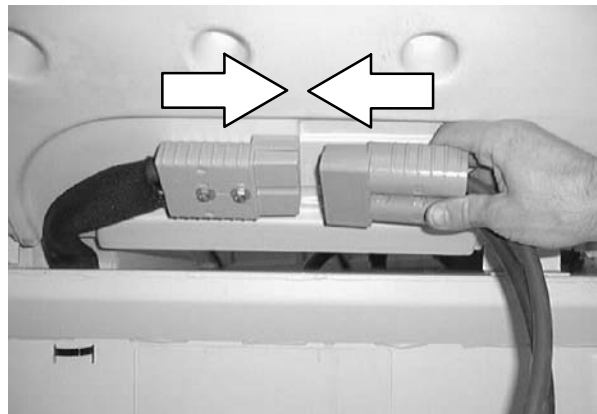

11. Operate the machine. Check the propelling circuit for proper operation.

INSTRUMENT PANEL

The instrument panel consists of a circuit board, a touch panel, and a water/dust resistant plastic enclosure. Its touch panel controls various machine functions, while its indicator lights keep the operator informed on machine performance.



TO REPLACE TOUCH PANEL

FOR SAFETY: Before Leaving Or Servicing Machine; Stop On Level Surface, Set Parking Brake.

1. Raise the rear cover and unplug the battery connector.

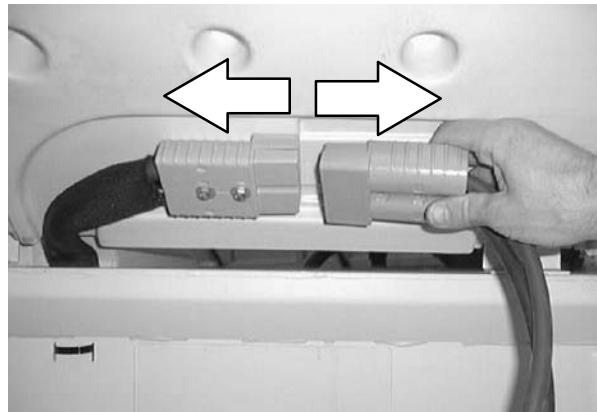

2. Open the top cover and side door.

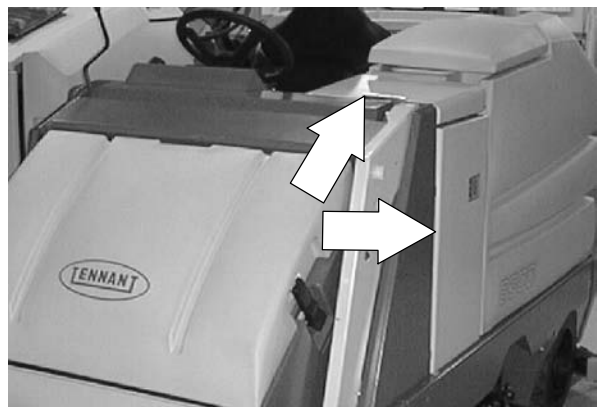

ELECTRICAL

3. Remove the four screws and washers holding the instrument panel to the steering support frame.



4. Remove the four wing nuts from the studs of the touch panel bezel.

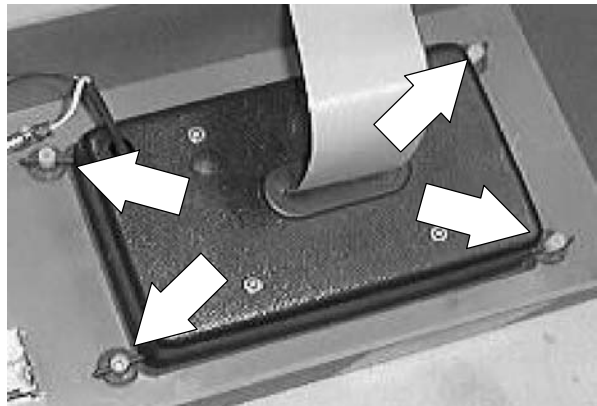

5. Pull the bezel off the touch panel.



6. Remove the four screws holding the cover on the small control panel.

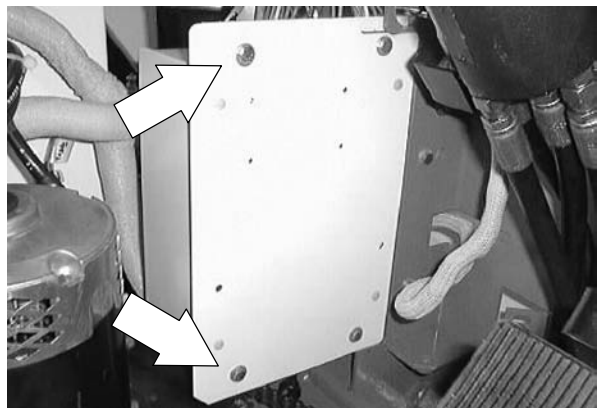

7. Unplug the touch panel ribbon cable from the circuit board.

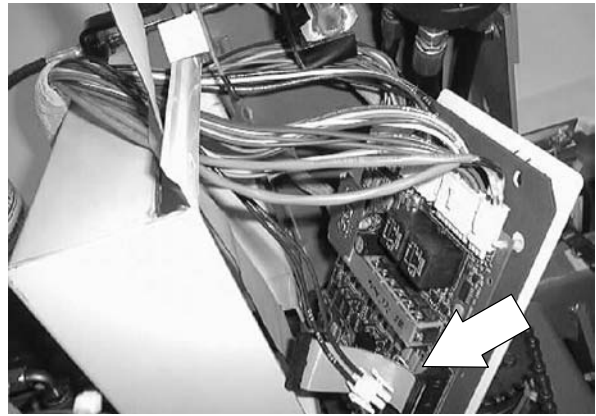

8. Route the ribbon cable out of the small control panel.

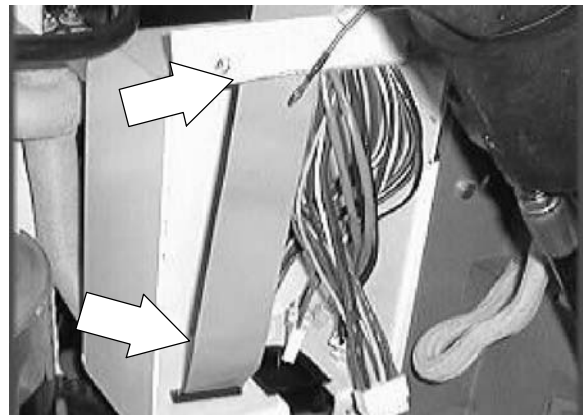

9. Pull the touch panel assembly back. Route the ribbon cable out of the grommet on the dash mount plate. Remove the touch panel and ribbon cable from the machine.

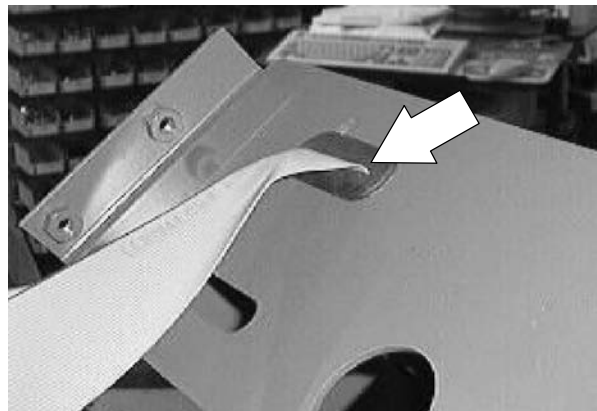

10. Install the new touch panel and ribbon assembly on the dash mount plate. Route the ribbon cable through the grommet and dash slot.



ELECTRICAL

11. Route the ribbon cable down to the small control panel, through the grommet, and into the box.

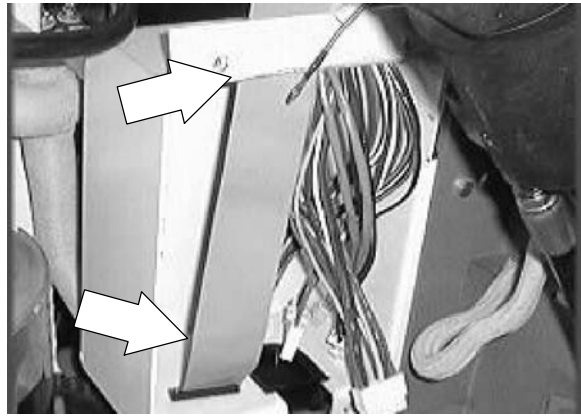

12. Plug the ribbon cable into the circuit board.



13. Reinstall the small control panel cover. Tighten the screws to 11 - 14 Nm (7 - 10 ft lb).

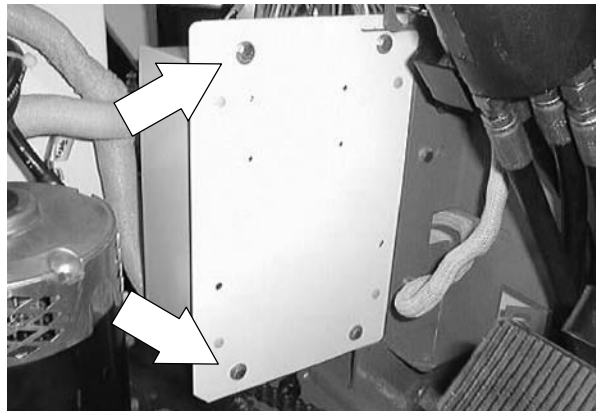

14. Position the touch panel and bezel onto the dash plate.



15. Reinstall the four wing nuts onto the four screws from the bezel.

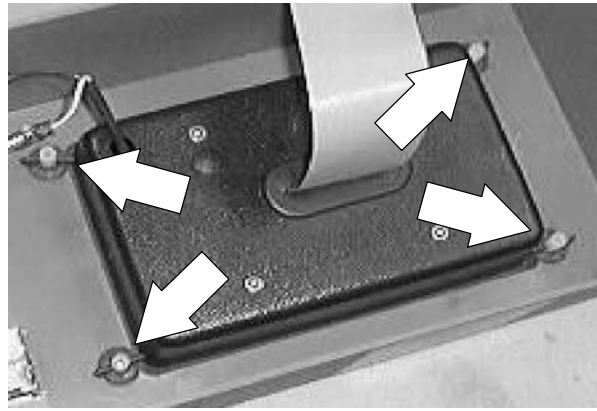

16. Position the instrument panel back onto the dash plate. Reinstall the four screws and special washers. Tighten the screws to 11 - 14 Nm (7 - 10 ft lb).



17. Close the top cover and side door.



18. Plug the battery connector into the machine. Close the rear cover.

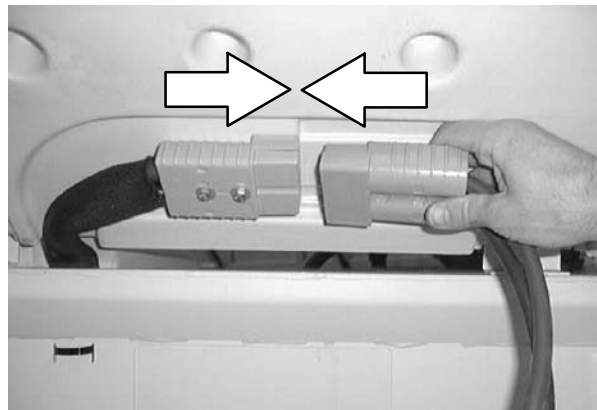

19. Operate the machine. Check the touch panel for proper operation.

ELECTRICAL

TO REPLACE SCRUBBING CIRCUIT BOARD

FOR SAFETY: Before Leaving Or Servicing Machine; Stop On Level Surface, Set Parking Brake.

1. Raise the rear cover and unplug the battery connector.

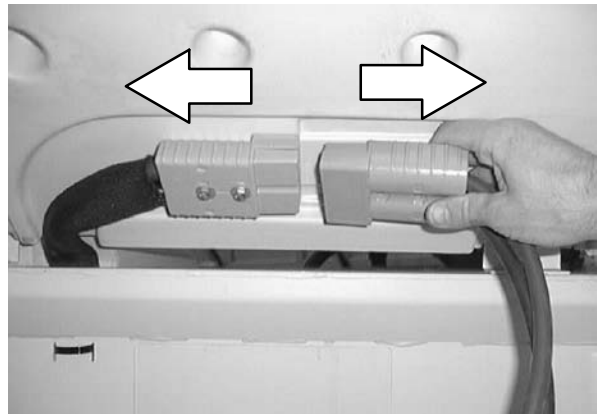

2. Open the top cover and side door.



3. Remove the four screws holding the cover on the small control panel.

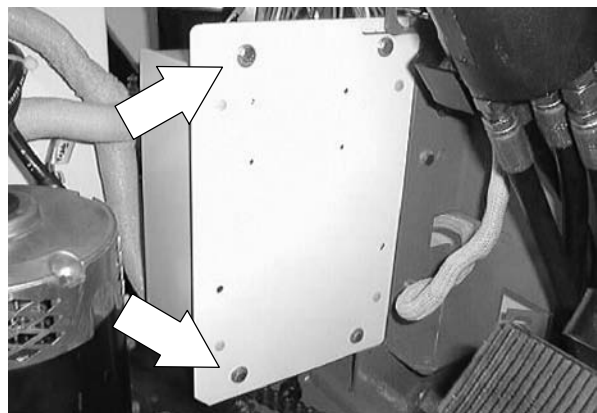

4. Pull the small control panel cover back to access the circuit board (s).

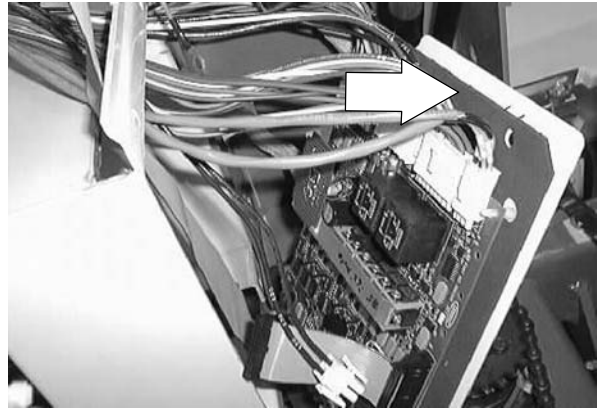

5. Unplug the wire connectors on top of the circuit board.

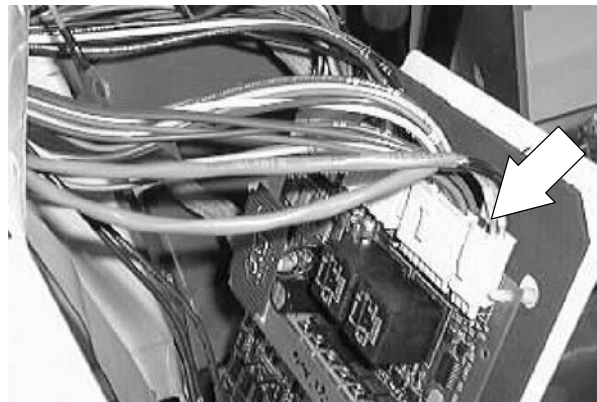

6. Unplug the ribbon cable from the circuit board.



7. Snap the circuit board off the plastic stand-offs holding the board to the cover. Remove the board from the machine. *Note orientation of the board.*

8. Position the new circuit board onto the panel cover in the same orientation as the old one was removed.



ELECTRICAL

9. Snap the new circuit board down onto the plastic stand-offs.



10. Reconnect the ribbon cable.

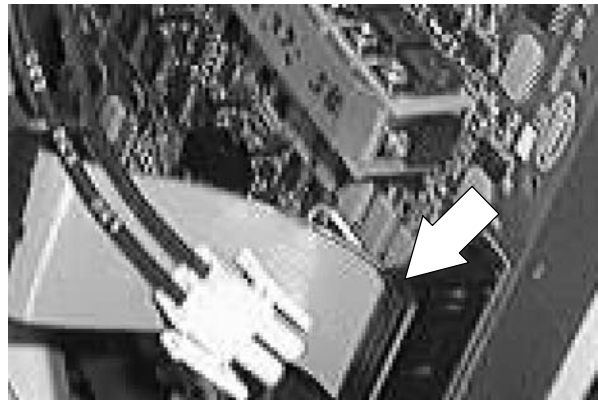

11. Reconnect the wire connectors on top of the circuit board.



12. Position the panel cover back on the control box. Reinstall the hardware and tighten to 11 - 14 Nm (7 - 10 ft lb).

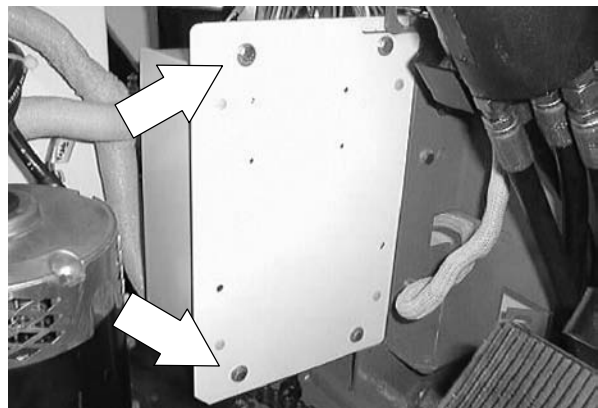

13. Close the top cover and side door.

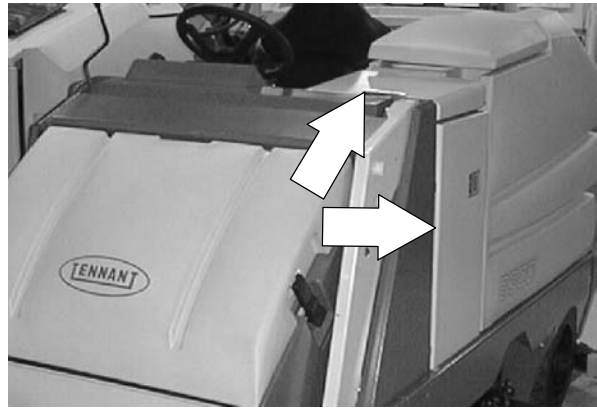

14. Plug the battery connector into the machine.
Close the rear cover.

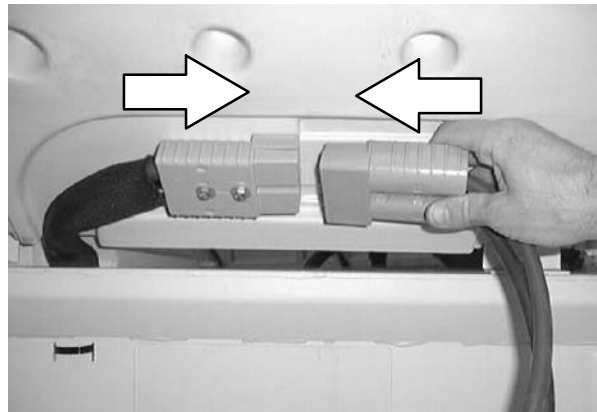

15. Operate the machine. Check the circuit board for proper operation.

ELECTRICAL

TO REPLACE SWEEPING CIRCUIT BOARD

FOR SAFETY: Before Leaving Or Servicing Machine; Stop On Level Surface, Set Parking Brake.

1. Raise the rear cover and unplug the battery connector.

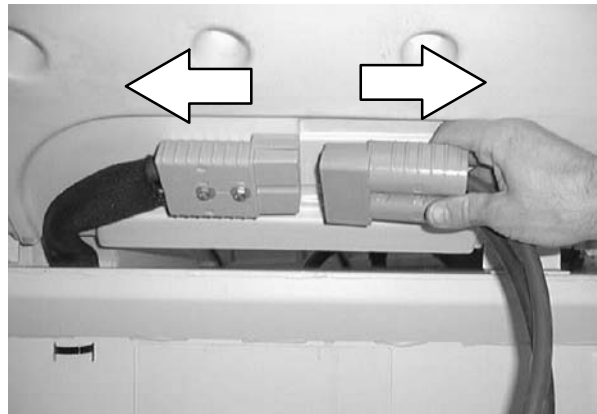

2. Open the top cover and side door.

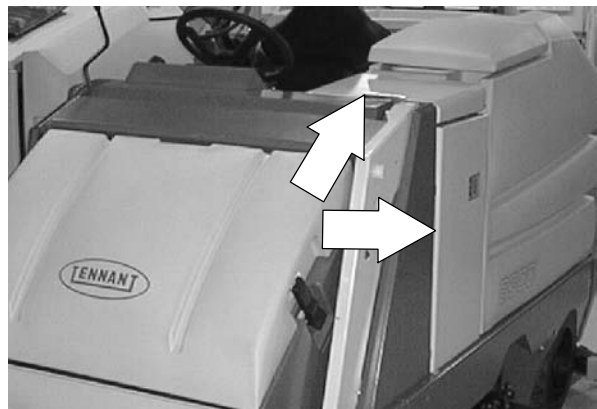

3. Remove the four screws holding the cover on the small control panel.

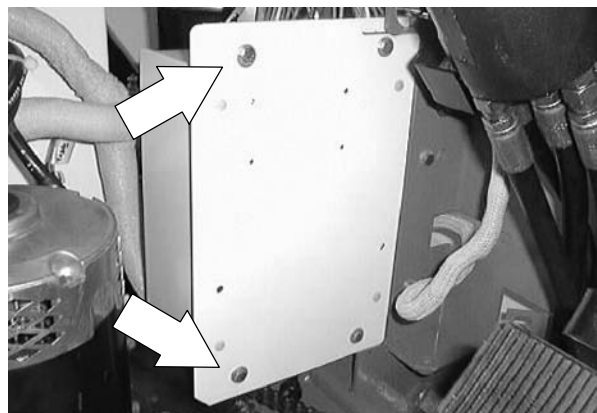

4. Pull the small control panel cover back to access the circuit board (s).

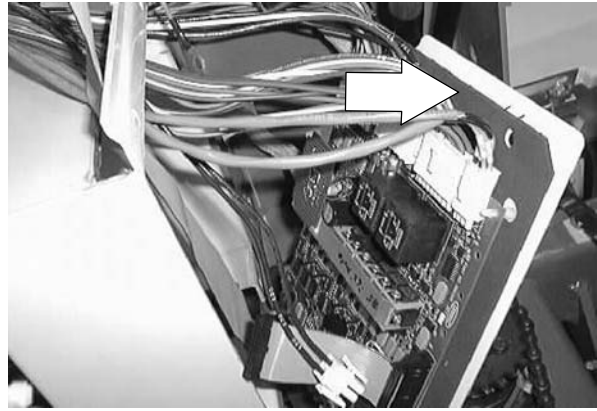

5. Unplug the wire connectors on top of the circuit board.

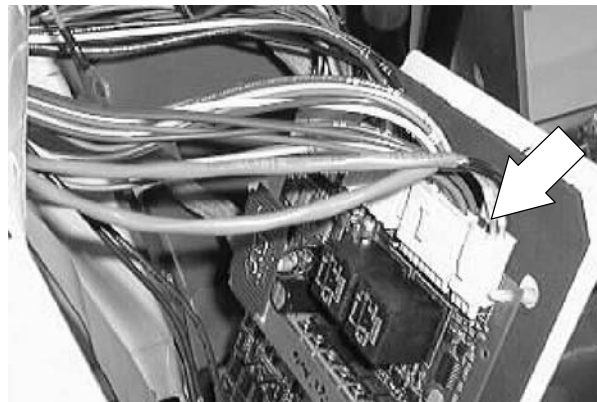

6. Unplug the ribbon cable from the circuit board.



7. Snap the circuit board off the plastic stand-offs holding the board to the cover. Remove the board from the machine. *Note orientation of the board.*

8. Position the new circuit board onto the panel cover in the same orientation as the old one was removed.



ELECTRICAL

9. Snap the new circuit board down onto the plastic stand-offs.

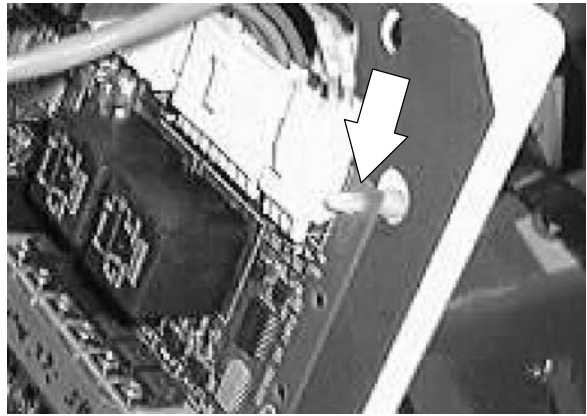

10. Reconnect the ribbon cable.

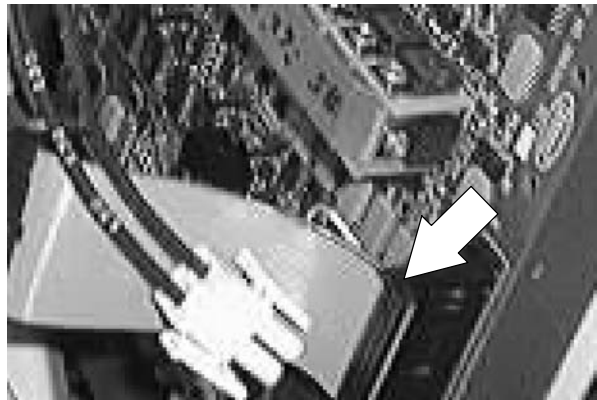

11. Reconnect the wire connectors on top of the circuit board.



12. Position the panel cover back on the control box. Reinstall the hardware and tighten to 11 - 14 Nm (7 - 10 ft lb).

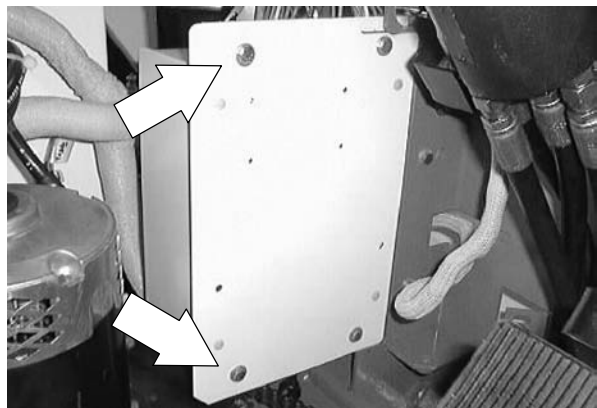

13. Close the top cover and side door.

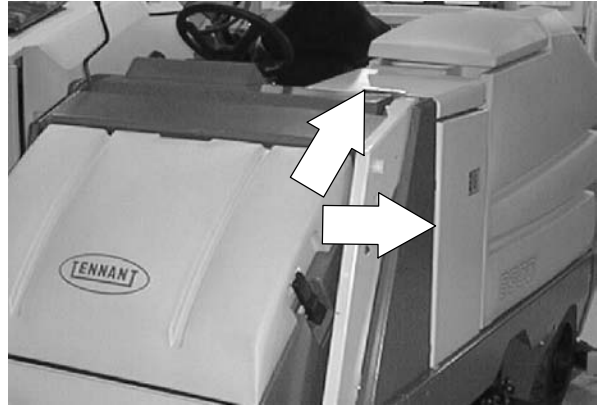

14. Plug the battery connector into the machine.
Close the rear cover.

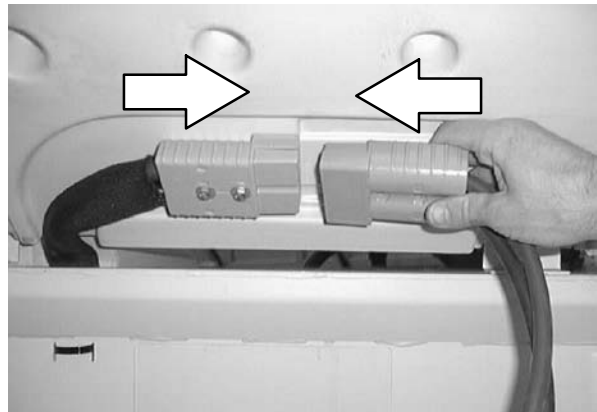

15. Operate the machine. Check the circuit board for proper operation.

DIRECTIONAL PEDAL

The directional pedal controls direction of travel and the propelling speed of the machine. You change the speed of the machine with the pressure of your foot; the harder you press the faster the machine travels.

The machine will coast for a short distance before changing direction when it is moving, and the direction is reversed with the directional pedal. Use the brake pedal to stop the machine.

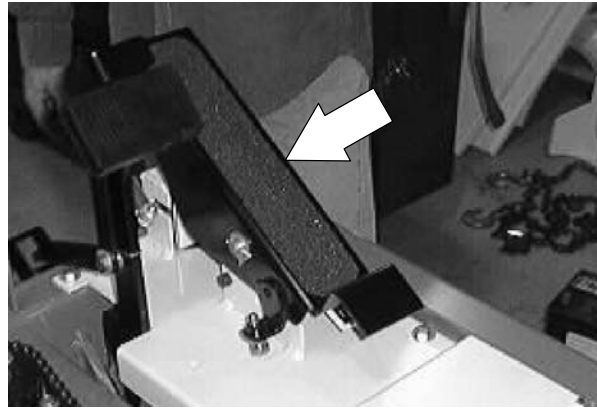

Forward: Press the top of the directional pedal with the toe of your foot.



Reverse: Press the bottom of the directional pedal with the heel of your foot.



Neutral: Take your foot off the directional pedal and it will return to the neutral position.

TO REPLACE CURTIS DIRECTIONAL CONTROL UNIT

FOR SAFETY: Before Leaving Or Servicing Machine; Stop On Level Surface, Set Parking Brake, Turn Off Machine And Remove Key.

1. Raise the rear cover and unplug the battery connector.

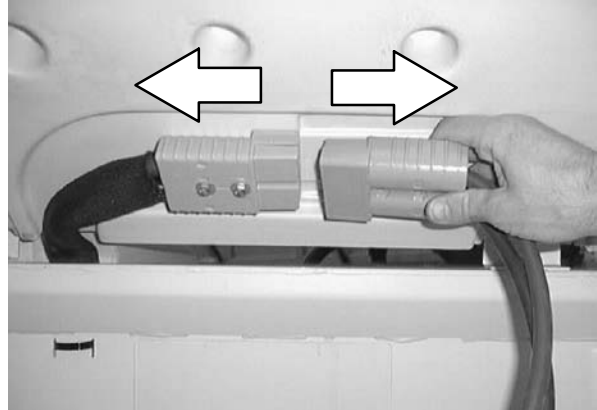

2. Open the top cover and side door.



3. Unplug the directional control unit from the main harness.

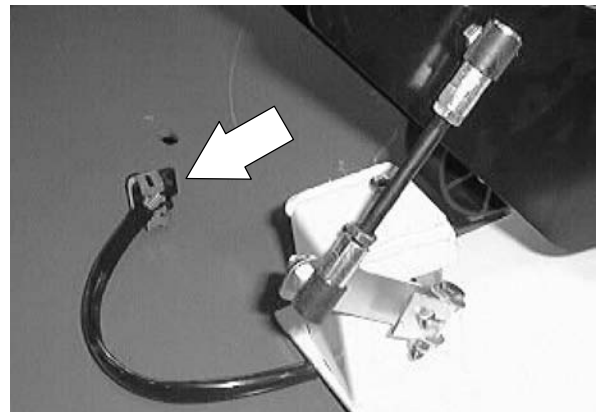

ELECTRICAL

4. Remove the M6 nyloc nut holding the upper balljoint to the pedal of the directional control unit.

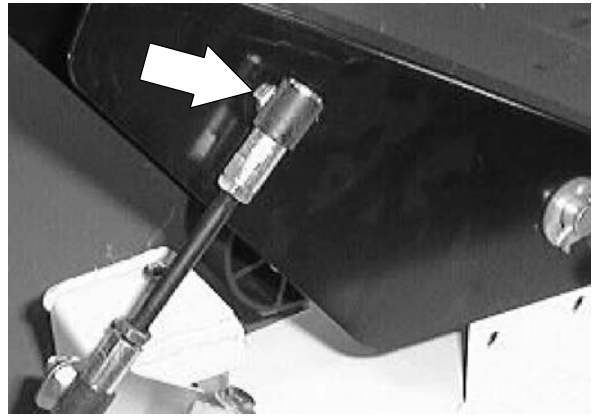

5. Remove the cotter pin from the large clevis pin holding the pedal to the directional control unit. Remove the pedal from the machine.

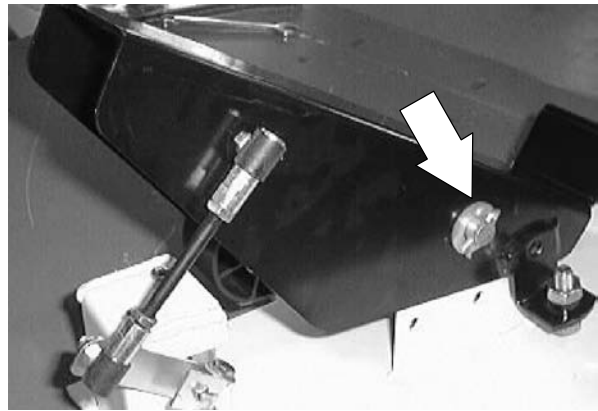

6. Remove the two pan screws holding the directional control unit to the mount bracket. Remove the unit from the mount bracket. *Push the rubber grommet out of the hole in the floor plate to let wire connector pass through.*

NOTE: Make sure to note the orientation of the accelerator lever on the shaft of the Curtis unit when it is in the neutral position.

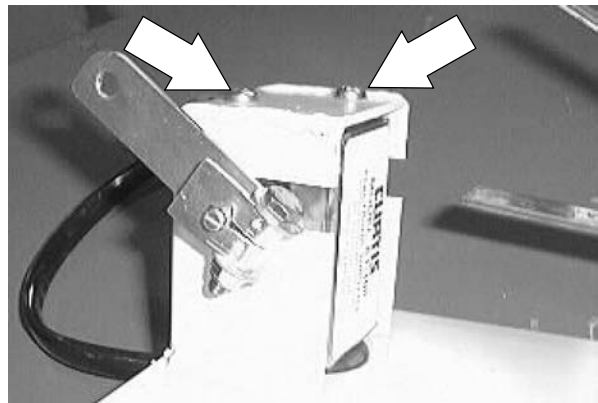

7. Loosen the hex screw and nut holding the lever and rod to the Curtis accelerator unit. Remove the lever and rod assembly from the unit.

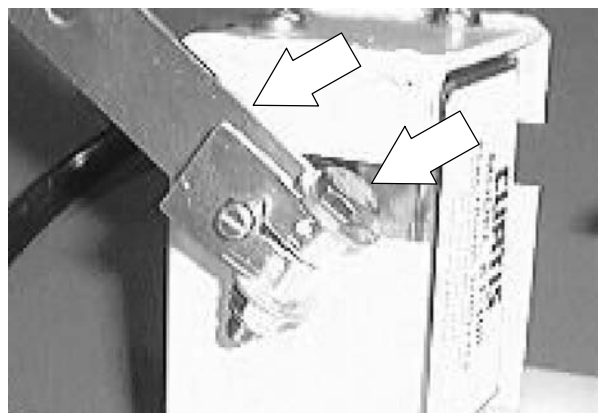

8. Place the arm assembly in the same orientation on the new Curtis accelerator unit. Hand tighten the hex screw tight.

NOTE: Make sure to position the accelerator lever on the shaft of the Curtis unit in the same orientation as it was removed.

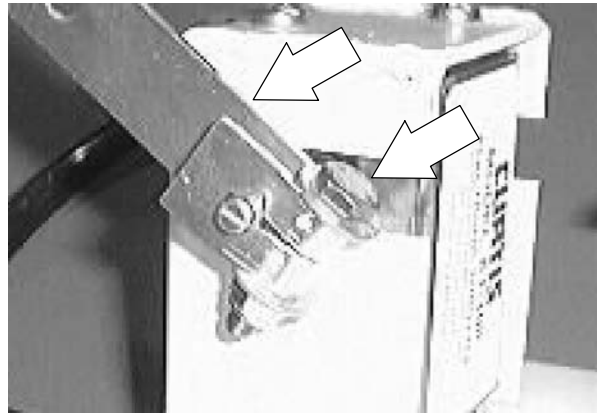

9. Position the new Curtis accelerator unit on the mount bracket. Reinstall the two pan screws and tighten to 7.6 - 9.9 Nm (5 - 6 ft lb). *Make sure the wire harness is placed through the grommet and the grommet is installed in the hole of the floor plate.*

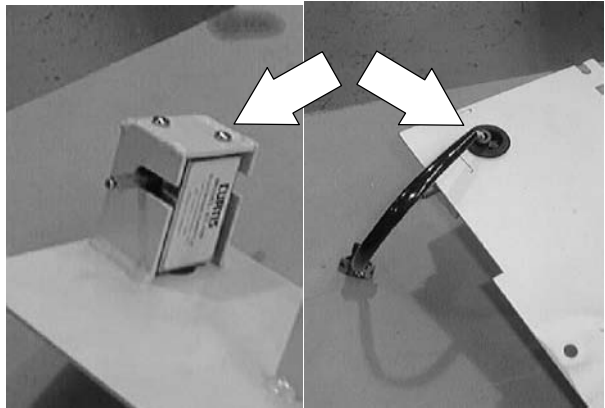

10. Position the pedal, clevis pin, and cotter pin onto the pedal mount brackets.

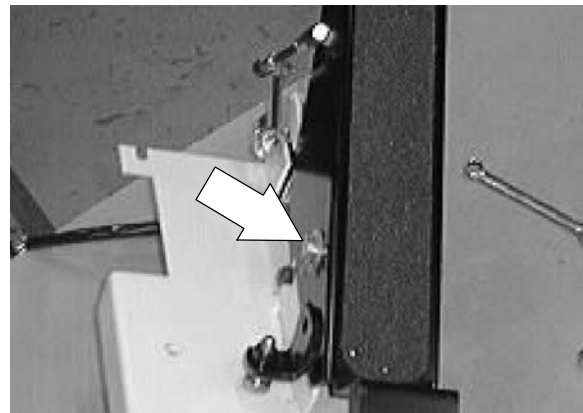

11. The pedal and accelerator arm should now be in their neutral position. Adjust the threaded rod and balljoint so it lines up with the hole in the pedal assembly. Reinstall the M6 nyloc nut and tighten to 7.6 - 9.9 Nm (5 - 6 ft lb).

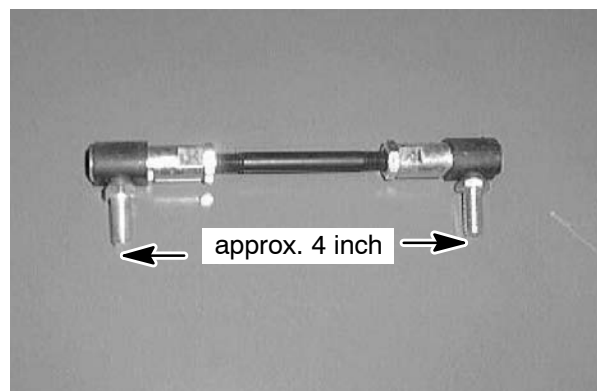

ELECTRICAL

12. Plug the new unit into the main harness connector.

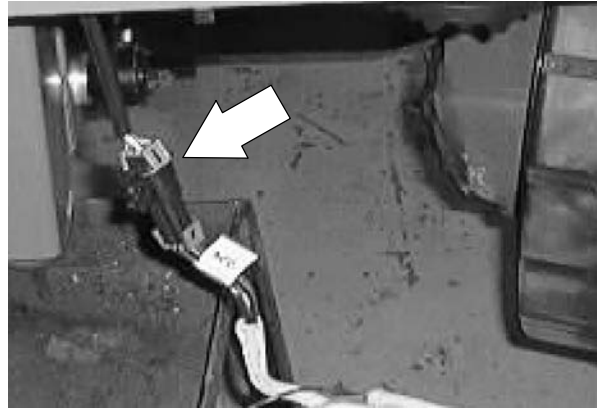

13. Close the top cover and side door.



14. Plug the battery connector into the machine.
Close the rear cover.

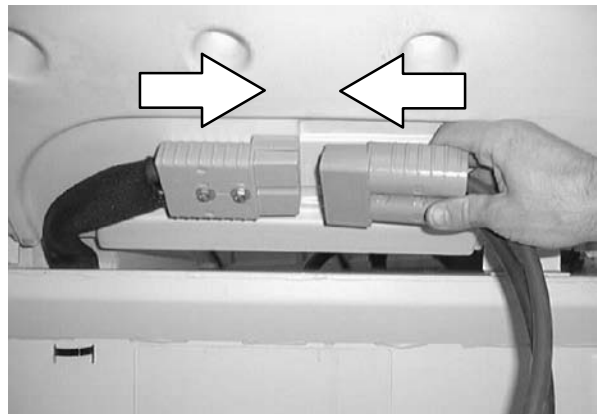

15. Start the machine. Move the accelerator into the forward and reverse positions checking for proper operation.

TO REPLACE TRACTION MOTOR CONTROLLER

FOR SAFETY: Before Leaving Or Servicing Machine; Stop On Level Surface, Set Parking Brake, Turn Off Machine And Remove Key.

1. Raise the rear cover and unplug the battery connector.

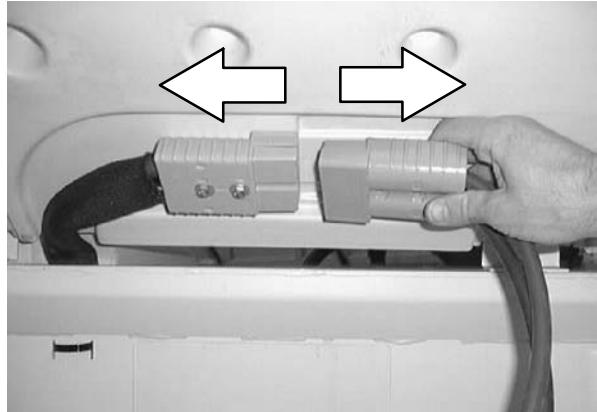

2. Open the top cover and side door.

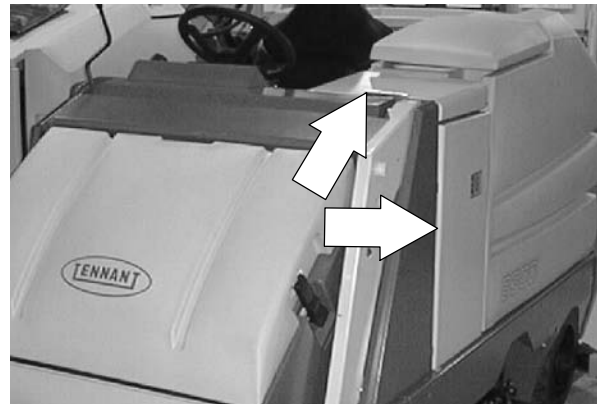

3. Remove the detergent tank and main control panel cover from the machine.

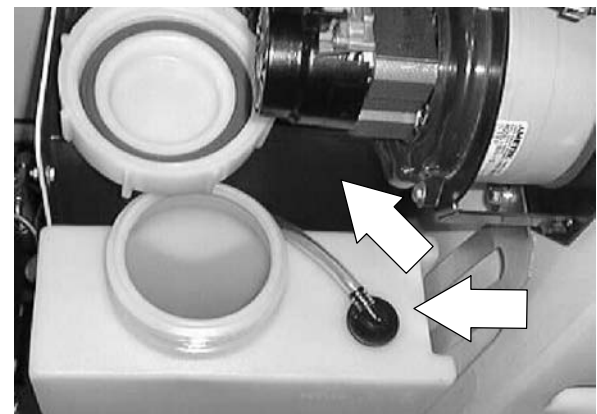

ELECTRICAL

4. Locate the traction motor controller in the control box.

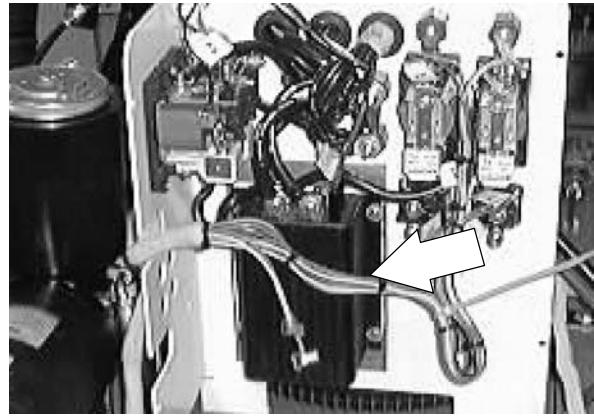

5. Mark and disconnect the electrical cables and smaller wires leading to the top of the controller.



6. Remove the four hex screws holding the controller to the control panel. Remove the controller from the machine.

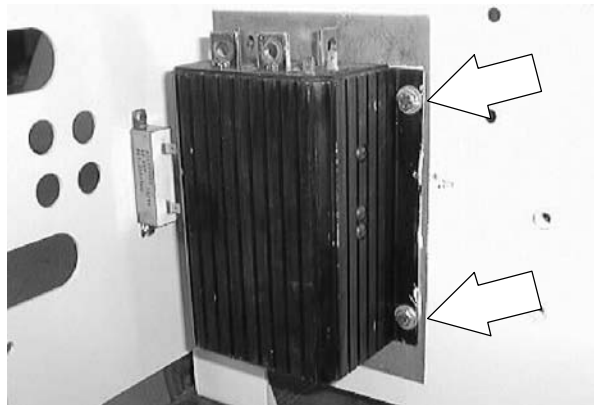

7. Cover the back side of the new controller with electrical thermal grease.

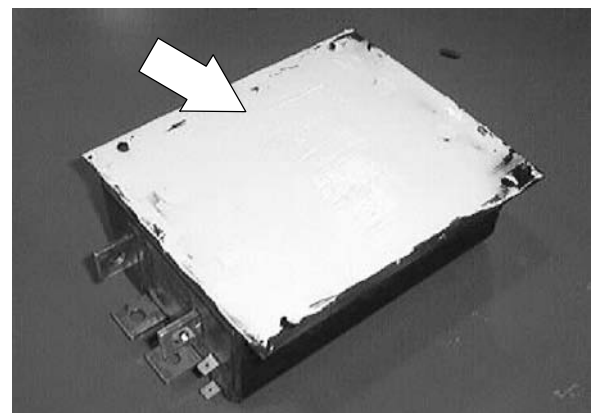

8. Install the new controller onto the control panel. Reinstall the four hex screws. Tighten to 7.6 - 9.9 Nm (5 - 6 ft lb).

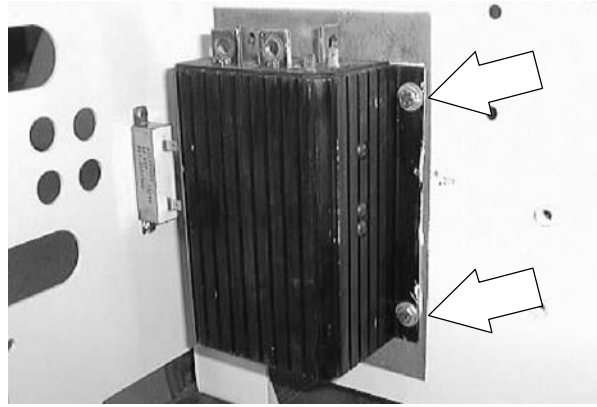

9. Reconnect the electrical cables and smaller wires leading to the top of the controller.

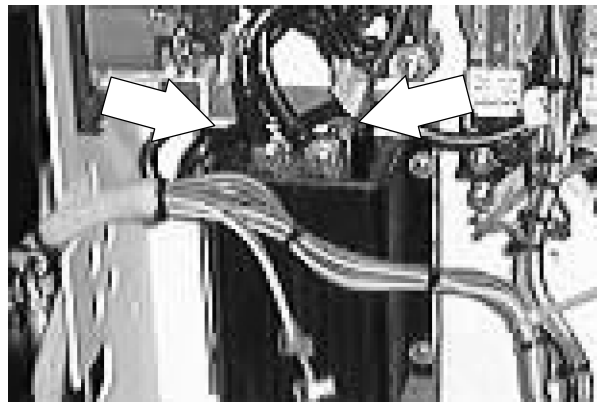

10. Reinstall the detergent tank and main control panel cover onto the machine.

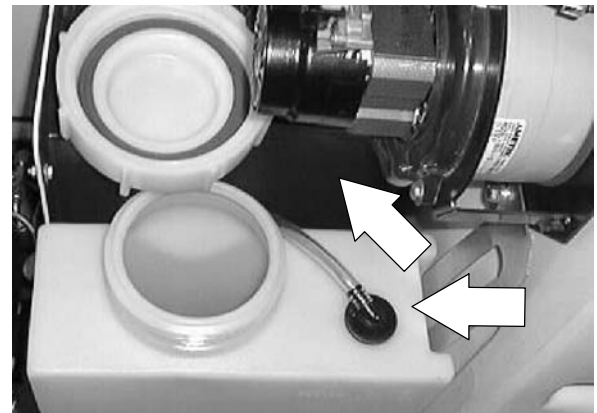

11. Close the top cover and side door.



ELECTRICAL

12. Plug the battery connector into the machine.
Close the rear cover.

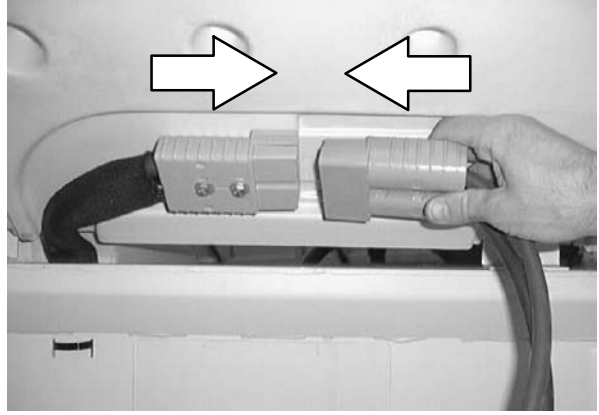

13. Start the machine. Check the new traction motor controller for proper operation.

TO REPLACE 36V RELAY

FOR SAFETY: Before Leaving Or Servicing Machine; Stop On Level Surface, Set Parking Brake, Turn Off Machine And Remove Key.

1. Raise the rear cover and unplug the battery connector.

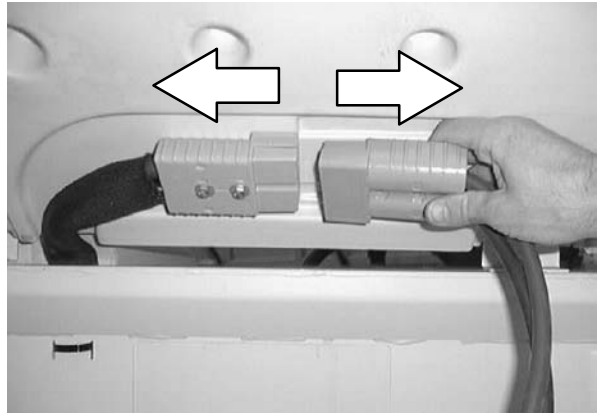

2. Open the top cover and side door.

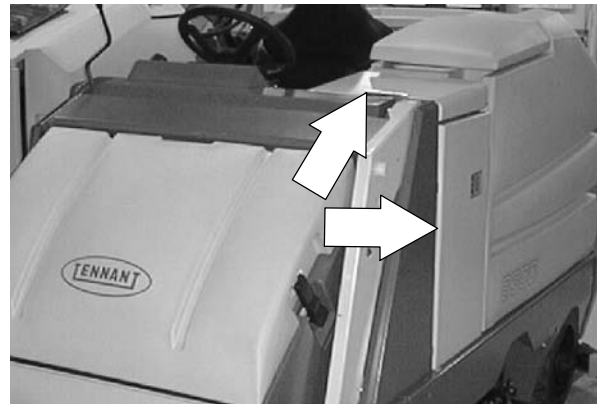

3. Remove the detergent tank and main control panel cover from the machine.

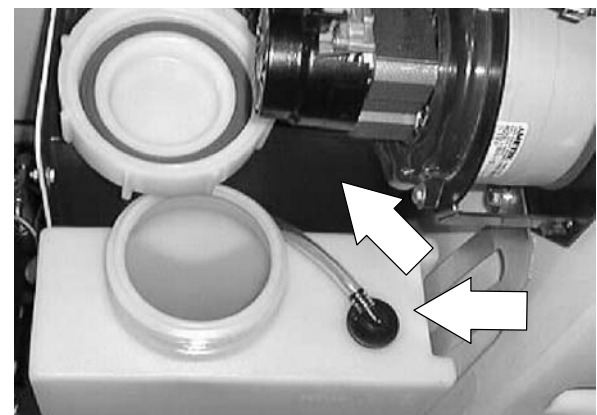

ELECTRICAL

4. Locate the 36V relays in the control box.

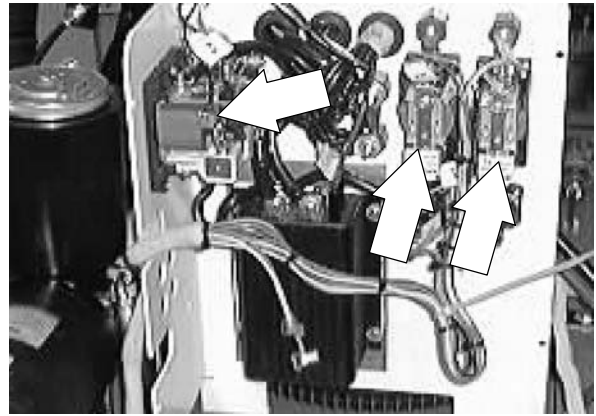

5. Mark and disconnect the electrical cables and smaller wires leading to the 36V relay.

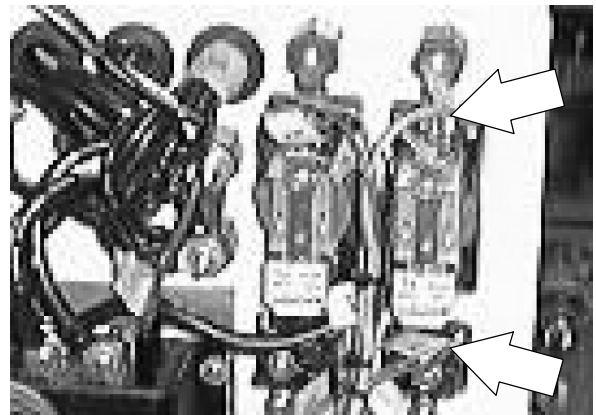

6. Remove the two hex screws holding the 36V relay to the control panel. Remove the relay from the machine.

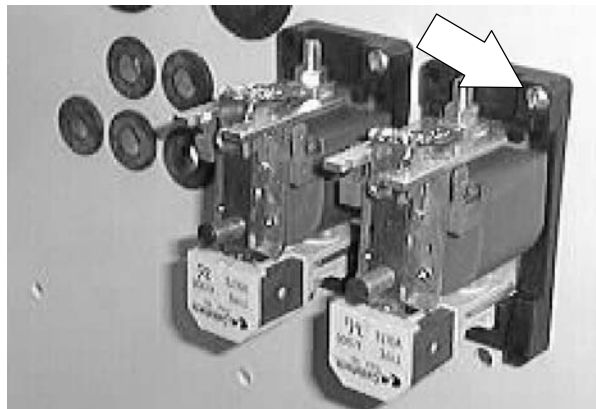

7. Install the new 36V relay onto the control panel. Reinstall the two hex screws. Hand tighten lightly--do not over tighten.

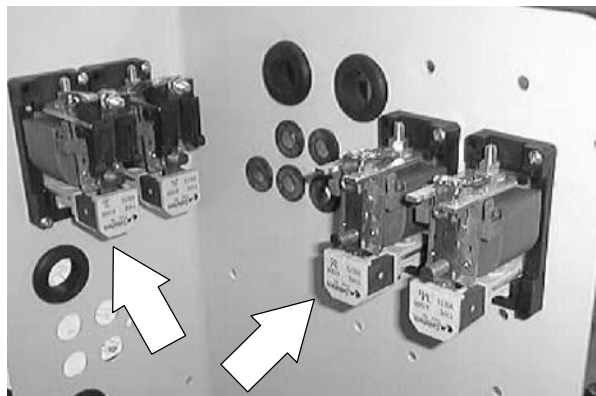

8. Reconnect the electrical cables and smaller wires leading to the top of the 36V relay.

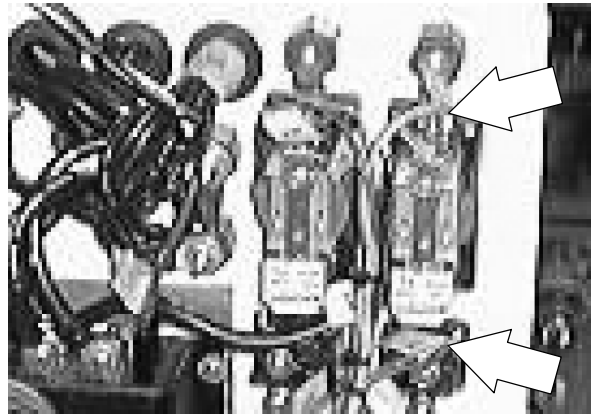

9. Reinstall the detergent tank and main control panel cover onto the machine.

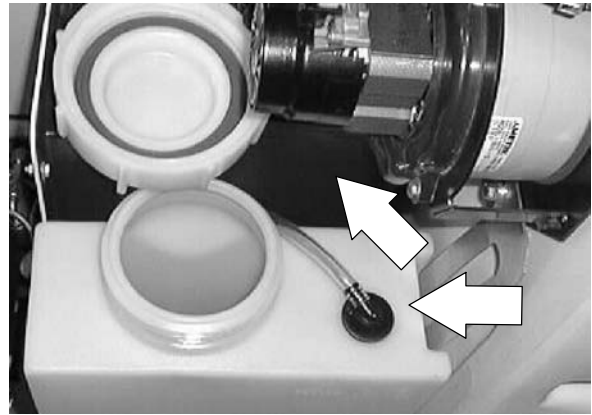

10. Close the top cover and side door.

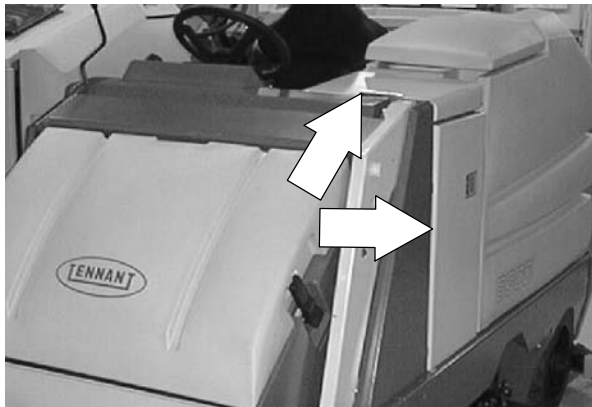

11. Plug the battery connector into the machine. Close the rear cover.

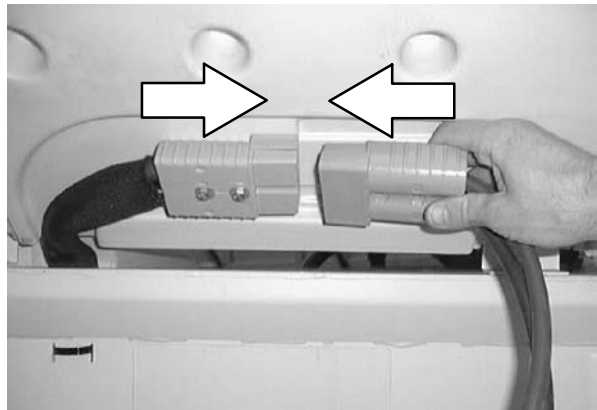

12. Start the machine. Check the new traction motor controller for proper operation.

TO REPLACE TRACTION MOTOR

FOR SAFETY: Before Leaving Or Servicing Machine; Stop On Level Surface, Set Parking Brake.

1. Engage the parking brake, block the rear tires.

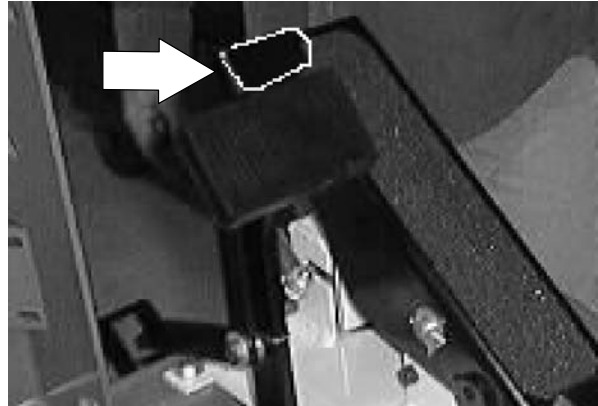

2. Jack up the front of the machine. Use jack stands to support the machine.

FOR SAFETY: Block machine tires before jacking machine up. Jack machine up at designated locations only. Block machine up with jack stands.



3. Open the top cover and side door.



4. Open the battery cover and un-plug the battery connector from the machine.

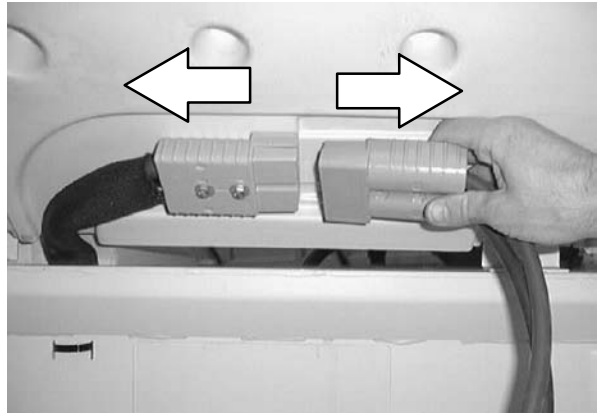

5. Remove the plastic traction motor cover.



6. Mark and disconnect the four electrical cables leading to the traction motor.



7. Remove the front tire and wheel assembly from the traction motor hub.

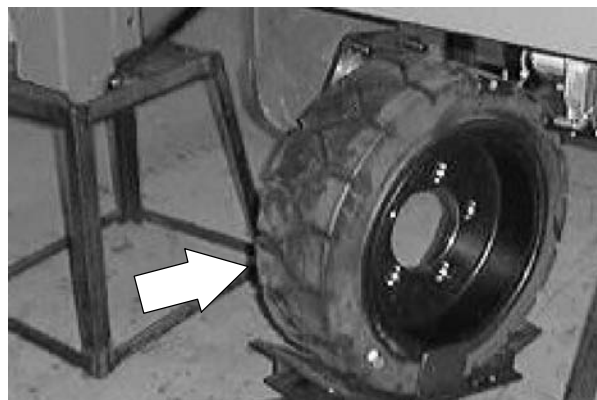

ELECTRICAL

8. Remove the three M8 socket head cap screws holding the traction motor to the drive gear box.

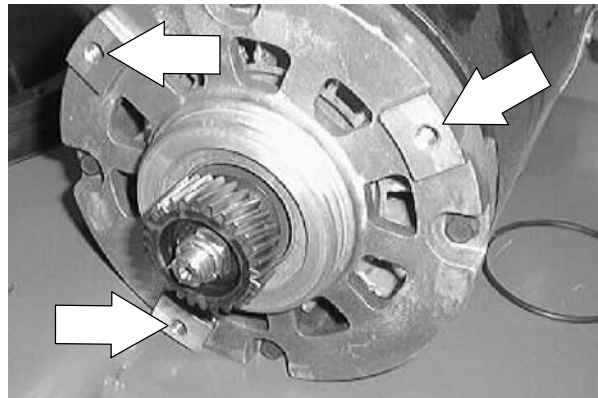

9. Pull the traction motor straight up and out of the drive gear box. Remove it from the machine.

NOTE: Be careful not to loose the rubber o-ring that is on the bottom of the motor.

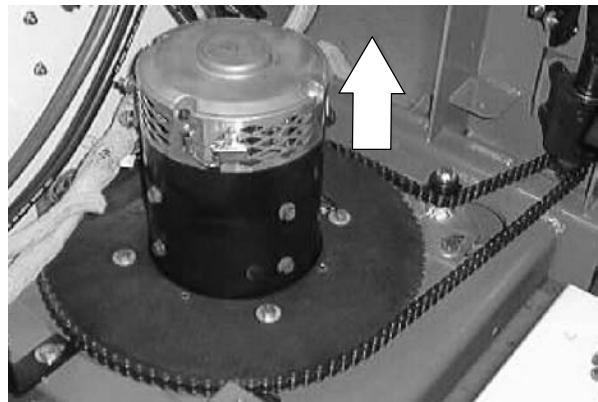

10. Remove the 0.50 in x 20 thin nyloc holding the drive gear to the motor shaft.

NOTE: A puller must be used to remove the gear from the shaft.

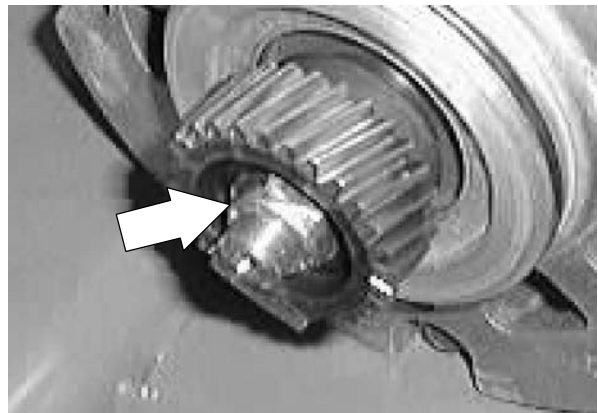

11. Place the gear and key on the new motor shaft. Tighten to 14 - 18 Nm (10 - 13 ft lb).

NOTE: Before the motor is reinstalled, mark the position of the threaded mounting holes in the bottom of the motor. Go far enough up the side of the motor so the mark can be seen when the motor is in its position in the drive gear box.

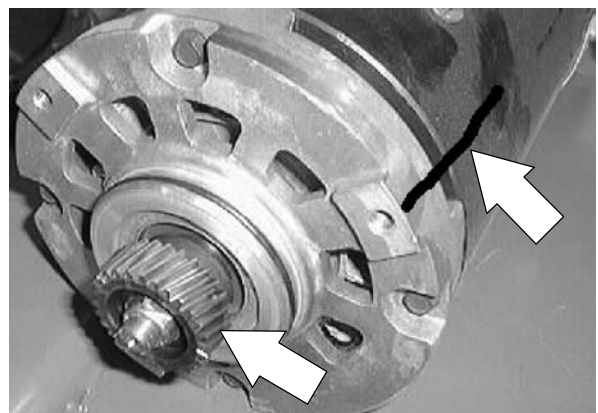

12. Position the traction motor back on the gear box housing. Make sure the electric cable studs are pointing towards the LH side of the machine.

NOTE: Make sure the O-ring is installed on the bottom of the motor.

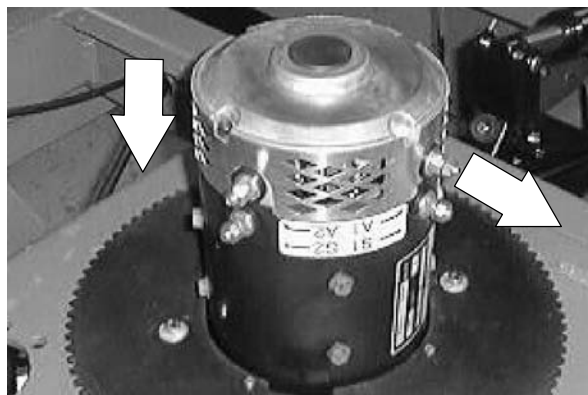

13. Reinstall the three M8 socket head cap screws holding the traction motor to the drive gear box. Tighten to 26 - 34 Nm (20 - 26 ft lb).

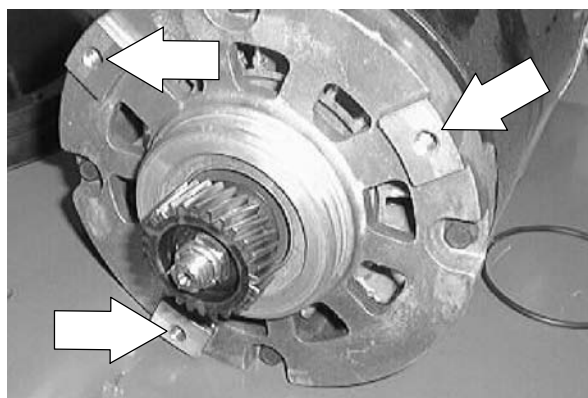

14. Install front tire. Tighten nuts to 122-150 Nm (90-110 ft lb).



15. Reconnect the four electrical cables going to the traction motor. See the schematic in this section.



ELECTRICAL

16. Reinstall the plastic traction motor cover.

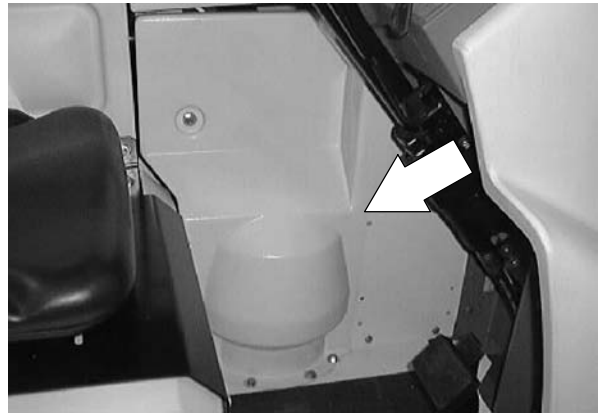

17. Plug in the battery connector. Close the battery cover.

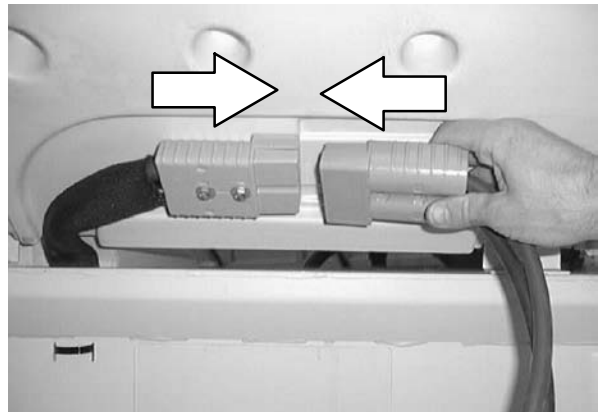

18. Close the top cover and side door.

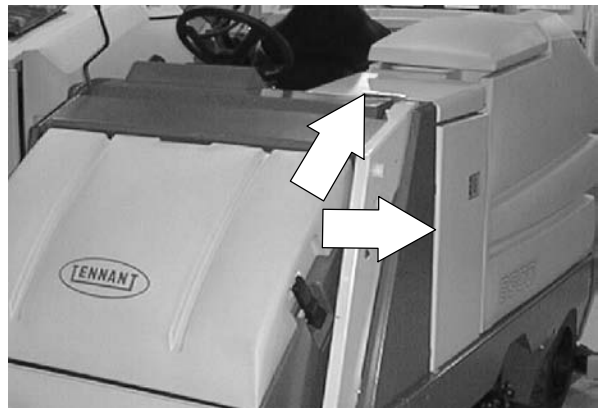

19. Lower the machine to the ground and check the new traction motor for proper operation.

PROPEL MOTOR BREAKDOWN

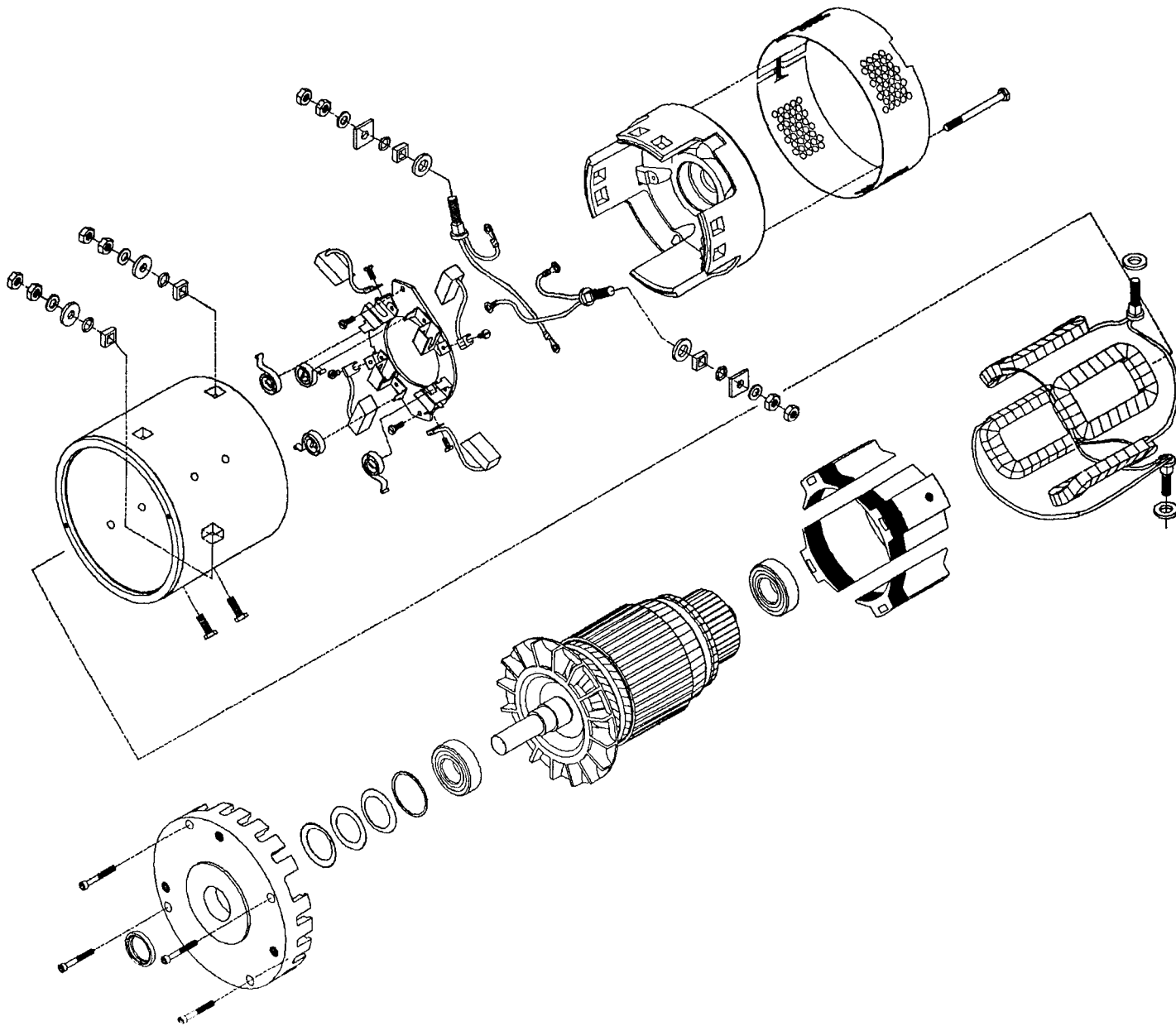

ELECTRICAL

TO REPLACE DISC SCRUB HEAD BRUSH MOTOR

FOR SAFETY: Before Leaving Or Servicing Machine; Stop On Level Surface, Set Parking Brake.

1. Remove both scrub brushes. See TO REPLACE DISC SCRUB BRUSH instructions in SCRUBBING section.

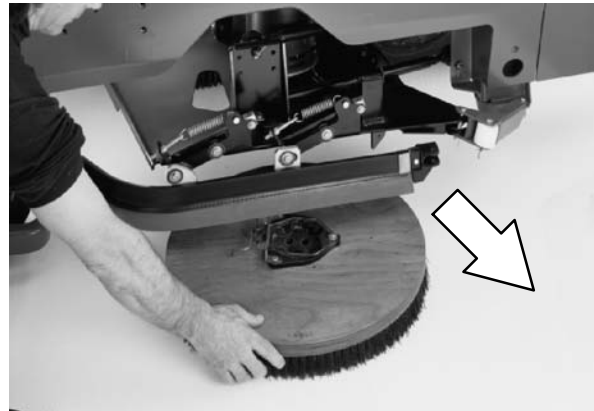

2. Disconnect the motor from the main harness.

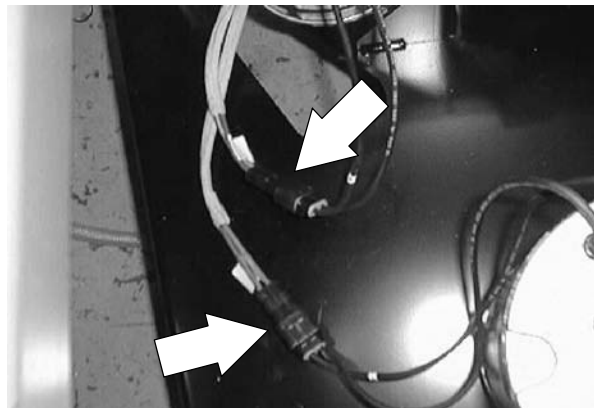

3. Go under the scrub head and remove the hex screw holding the scrub brush drive plug to the brush motor.

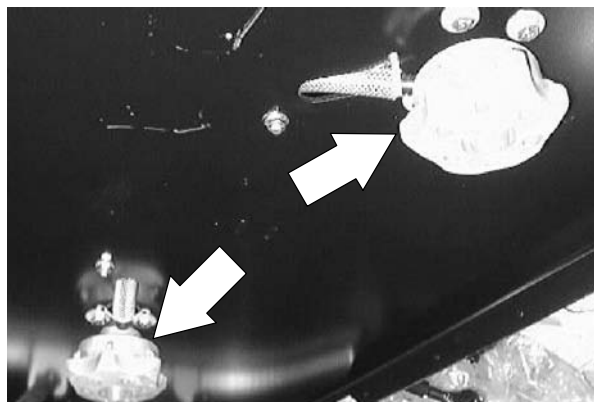

4. Pull the drive plug off the motor shaft. *Make sure to retain the two washers.*

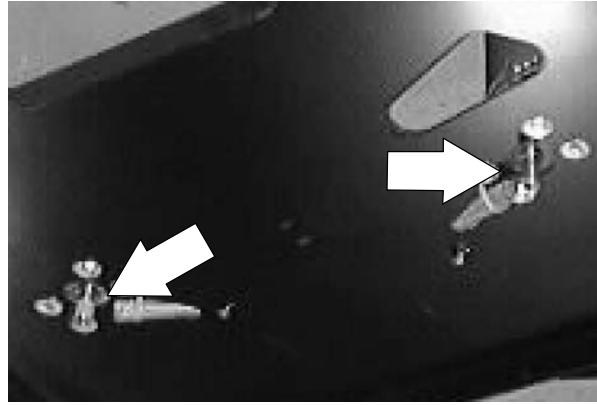

5. Remove the four hex screws holding the motor to the scrub head.

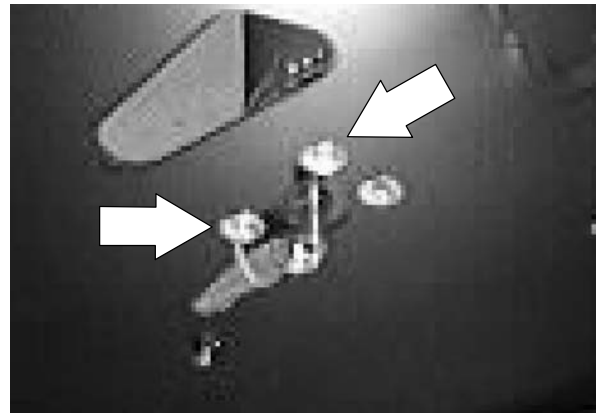

6. Start the machine and lower the scrub head. Shut off the machine.



7. Remove the motor from the machine. *Note the orientation of the motor on the top of the scrub head.*

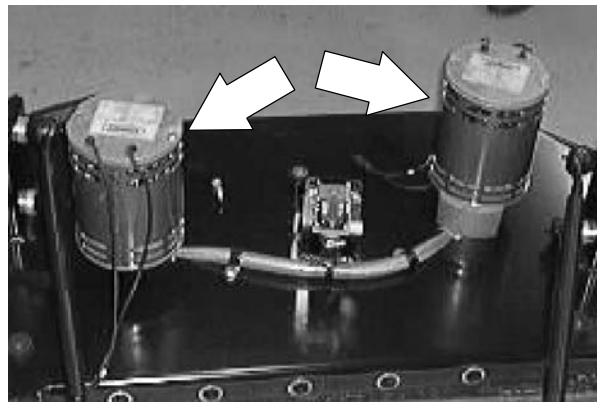

ELECTRICAL

8. Position the new motor onto the top of the scrub head frame. *Note the orientation of the motor on the top of the scrub head.*

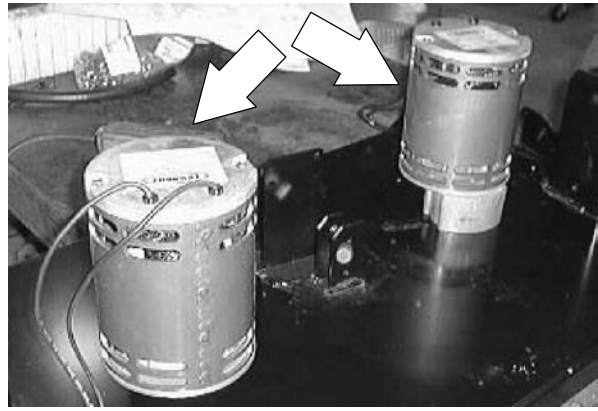

9. Reconnect the new motor to the main harness.

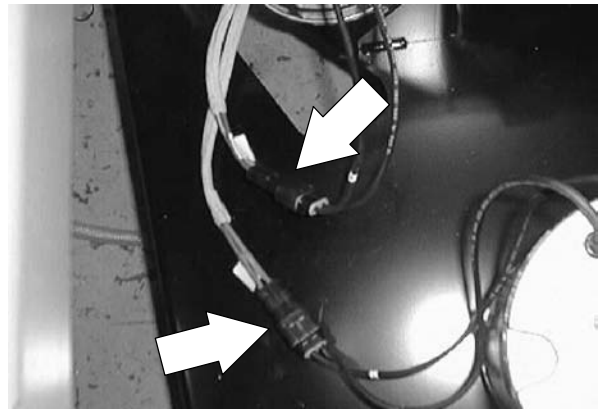

10. Start the machine and raise the scrub head. Shut off the machine.



11. Reinstall the four hex screws holding the motor to the scrub head. Tighten to 18 - 24 Nm (15 - 20 ft lb).

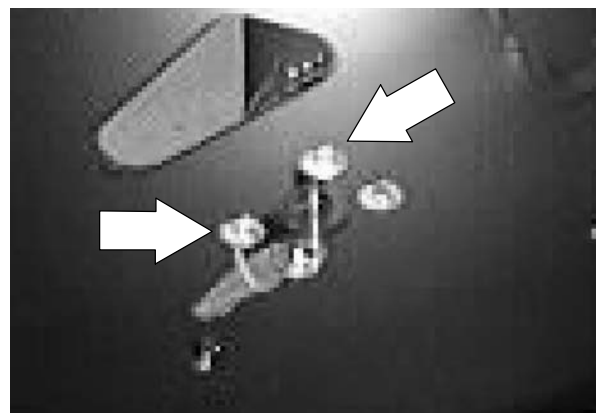

- Place a small amount of white lithium grease on the shaft of the new brush motor.

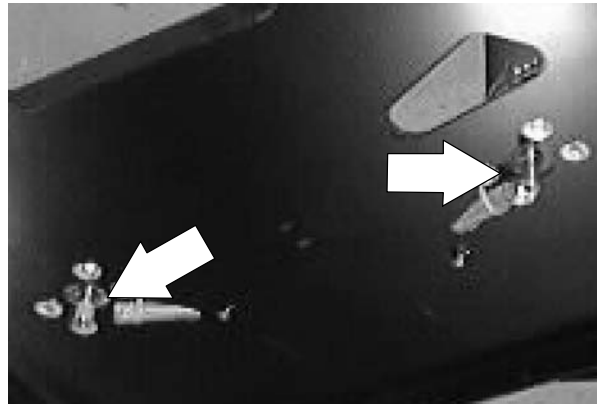

- Reinstall the brush drive hub onto the motor shaft. Reinstall the two washers and one hex screw. Tighten to 18 - 24 Nm (15 - 20 ft lb).

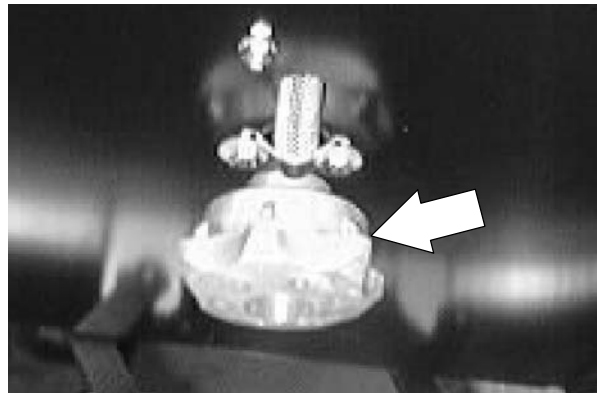

- Reinstall the scrub brushes. See TO REPLACE DISC SCRUB BRUSH instructions in SCRUBBING section.

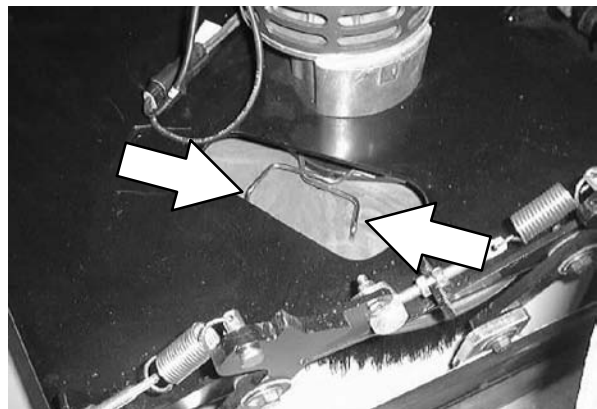

- Operate the machine. Check the new scrub brush motor for proper operation.

TO REPLACE CYLINDRICAL SCRUB HEAD BRUSH MOTOR

FOR SAFETY: Before Leaving Or Servicing Machine; Stop On Level Surface, Set Parking Brake.

1. Remove both scrub brushes. See TO REPLACE CYLINDRICAL SCRUB BRUSH instructions in SCRUBBING section. Lower the scrub head to the floor and shut off the machine.

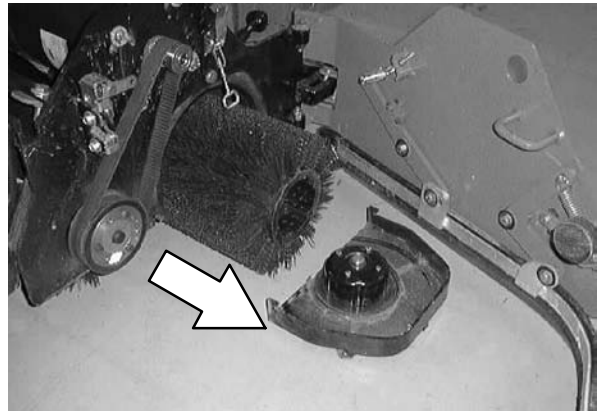

2. Disconnect the motor from the main harness.

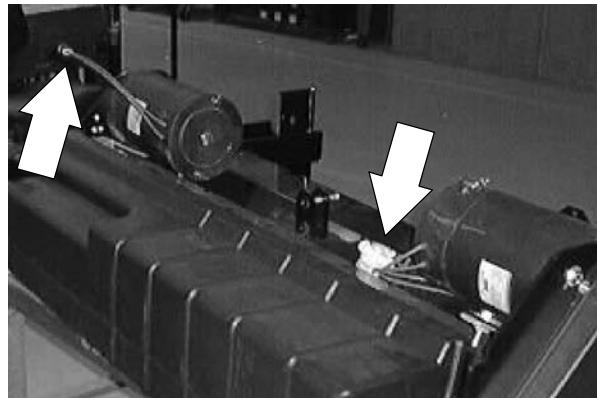

3. Remove the screws holding the plastic belt cover to the side of the scrub head. Remove the cover.

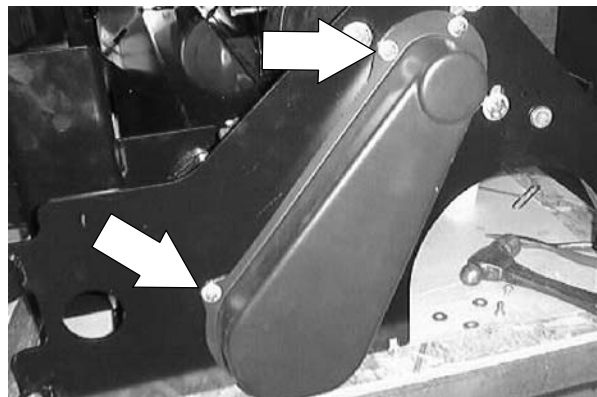

4. Loosen the four hex screws holding the scrub brush motor to the scrub head.

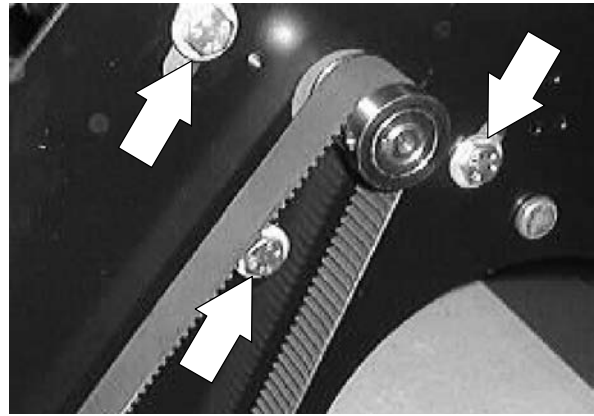

5. Loosen the hex screws holding the brush motor support strap to the mount bracket.

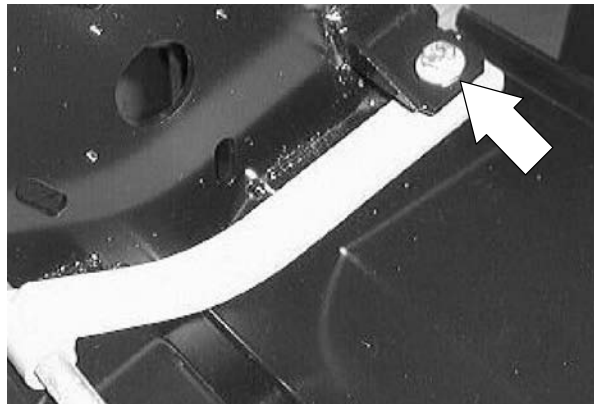

6. Let the scrub brush motor drop down in the slots.

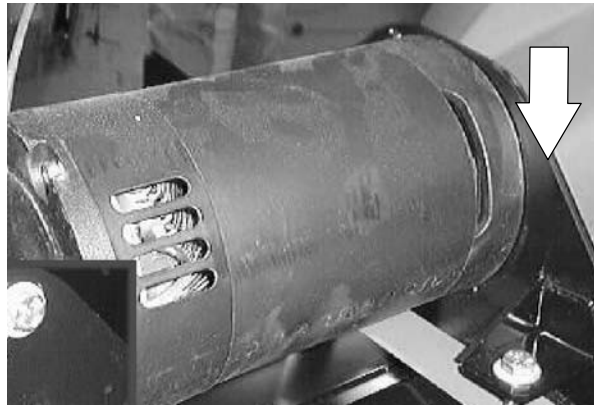

7. Remove the cogged drive belt from the grooved pulley on the brush motor.

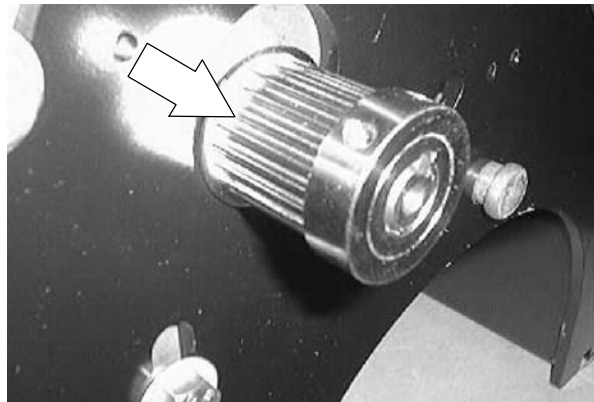

ELECTRICAL

8. Finish removing the four hex screws holding the scrub brush motor to the scrub head. Remove the motor from the machine.

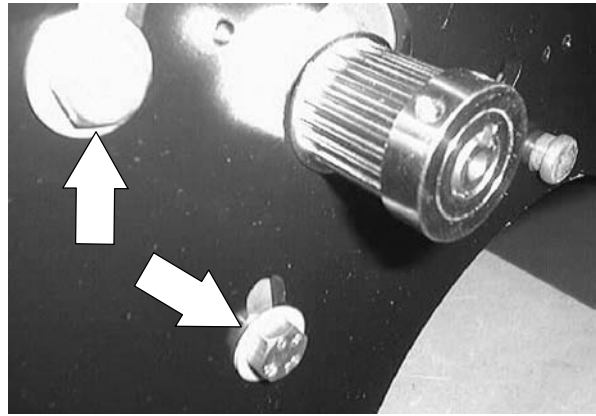

9. Loosen the allen screws holding the grooved pulley to the shaft of the scrub motor. Pull the pulley off the motor shaft. *Note the location of the pulley on the shaft.*

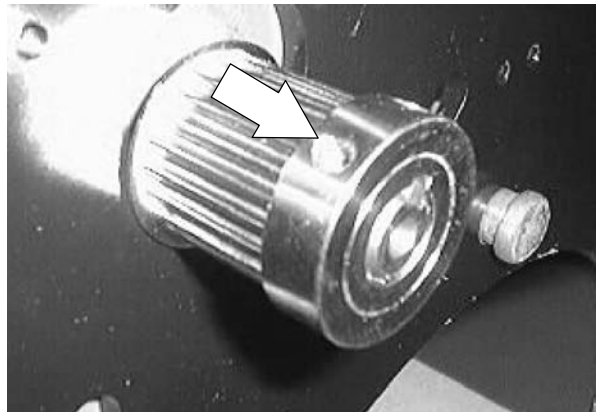

10. Install the grooved pulley onto the new scrub brush motor. *Position the pulley on the shaft in the same location as it was removed from the old motor.* Hand tighten the allen screws tight.

11. Position the new motor onto the scrub head. Reinstall the four hex screws. Leave loose for now.

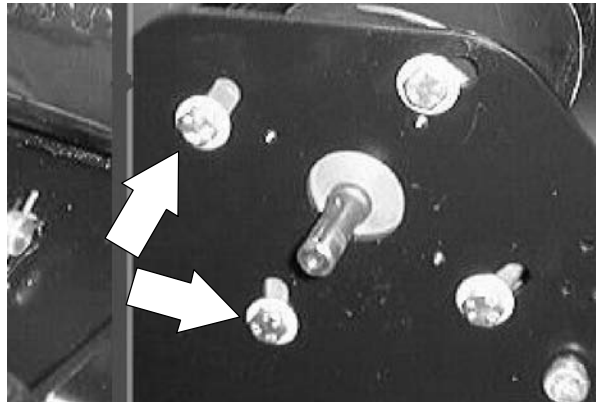

12. Position the cogged brush drive belt over the motor pulley.

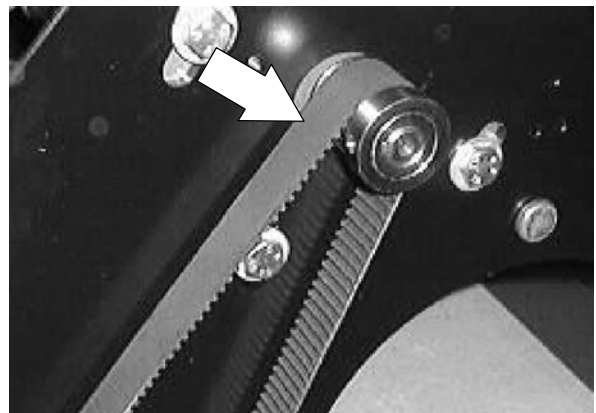

13. Use the brush motor support strap to move the brush motor up to tighten the cogged belt. Tighten the strap hex screw to 18 - 24 Nm (15 - 20 ft lb).
Check the belt tension. Use 4.2 to 4.6 lbs of force in the center span of the belt. Belt deflection should not exceed .10 inch (7/64 inch).

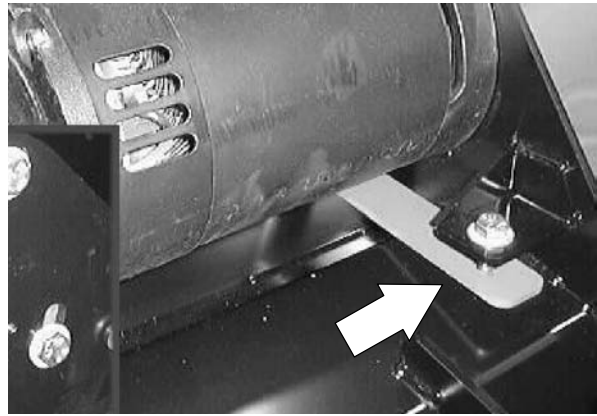

14. Go back and tighten the four brush motor screws to 37 - 48 Nm (26 - 34 ft lb).

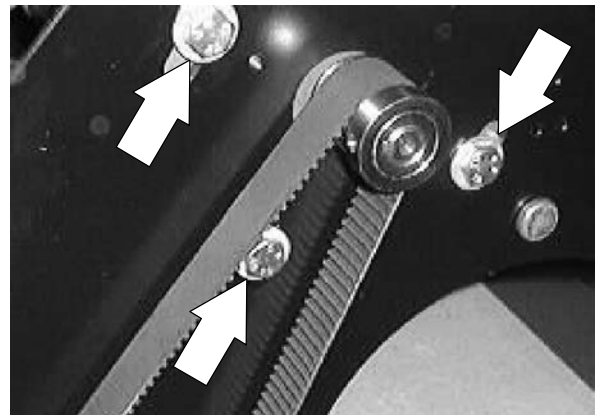

15. Check the alignment of the upper motor pulley with the lower drive pulley. Move the upper pulley in or out if needed.

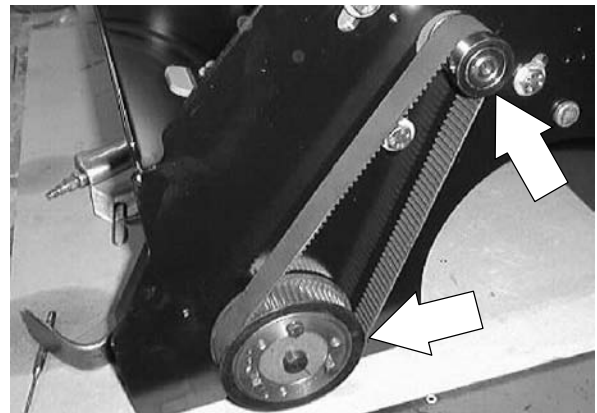

16. Reinstall the plastic belt cover. Reinstall the five pan screws holding the plastic cover to the scrub head. Hand tighten the screws tight.

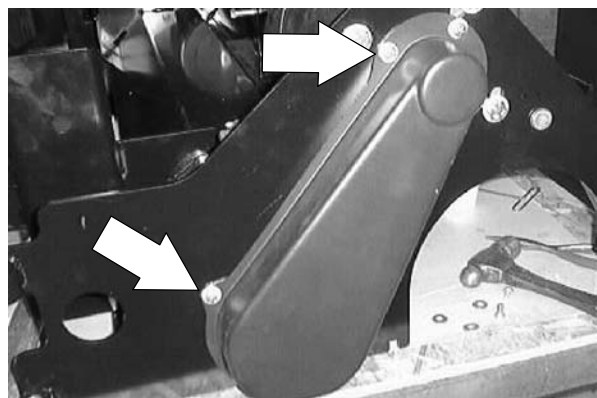

ELECTRICAL

17. Connect the new motor to the main electrical harness.

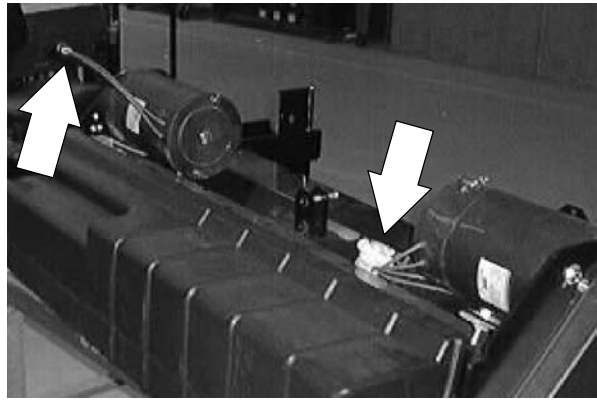

18. Reinstall the scrub brushes. See TO REPLACE CYLINDRICAL SCRUB BRUSH instructions in SCRUBBING section.

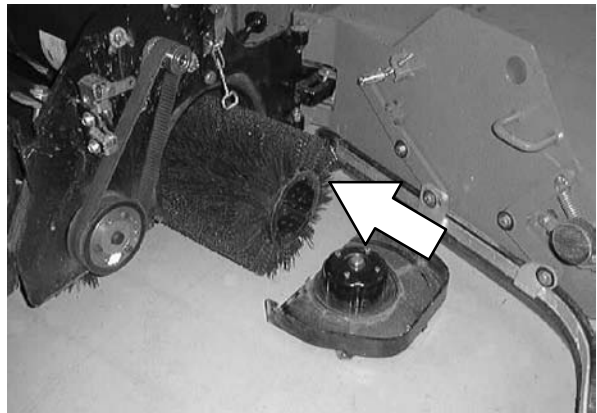

19. Operate the machine. Check the scrub brush motor for proper operation.

TO REPLACE SCRUB HEAD LIFT ACTUATOR

FOR SAFETY: Before Leaving Or Servicing Machine; Stop On Level Surface, Set Parking Brake.

NOTE: See instructions on page 4-54 if scrub head lift actuator has failed completely.

1. Remove the traction motor plastic cover.

NOTE: Lower the scrub head until it just touches the floor--shut off the key before the actuator produces any DOWN PRESSURE.



2. Disconnect and remove the battery from the rear of the machine. This will allow access to the rear mount clevis on the scrub head lift actuator.



3. Go to the operators compartment and remove the cotter pin and clevis pin from the actuator where it attaches to the scrub head lift pivot bracket.

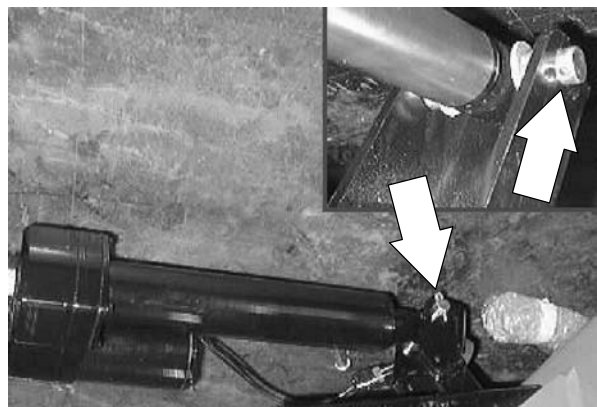

ELECTRICAL

4. Go to the battery compartment and remove the cotter pin and clevis pin from the actuator where it attaches to the machine frame.

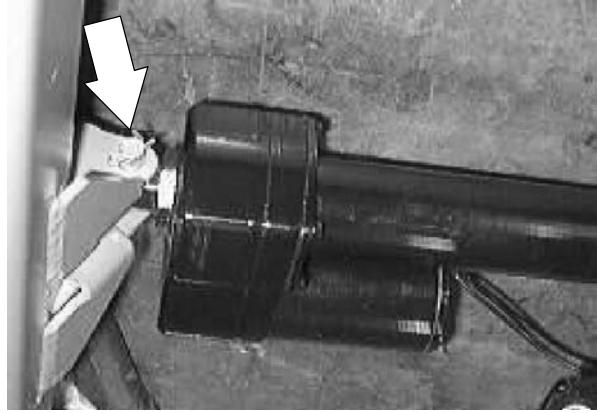

5. Go in to the center of the scrub head. Disconnect the scrub head lift actuator from the main harness.
6. Remove the existing actuator out the side of the machine.

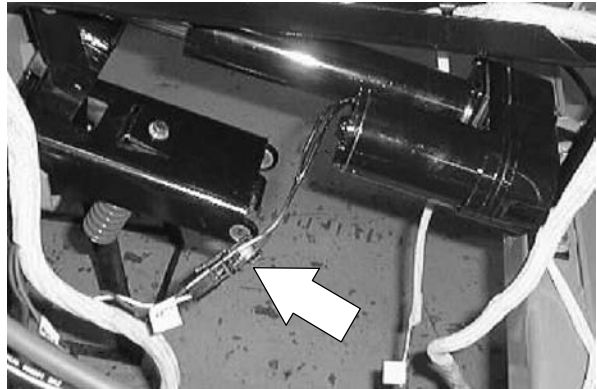

NOTE: Use the "Manual Mode" to extend/retract the new actuator for installation.

7. Position the new lift actuator in the machine. *The actuator motor should be pointing to the left side of the machine.*

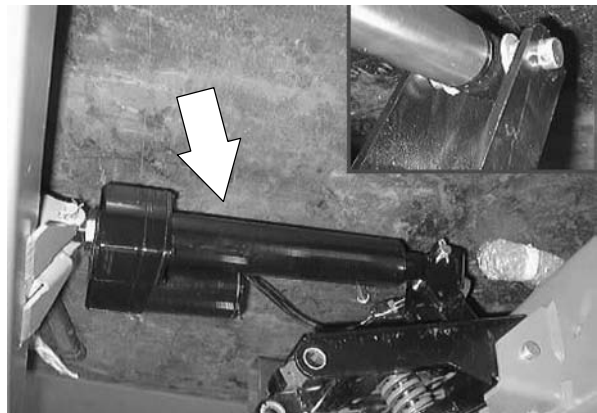

8. Reinstall the clevis pin and cotter pin into the actuator where it attaches to the machine frame (*battery compartment*).

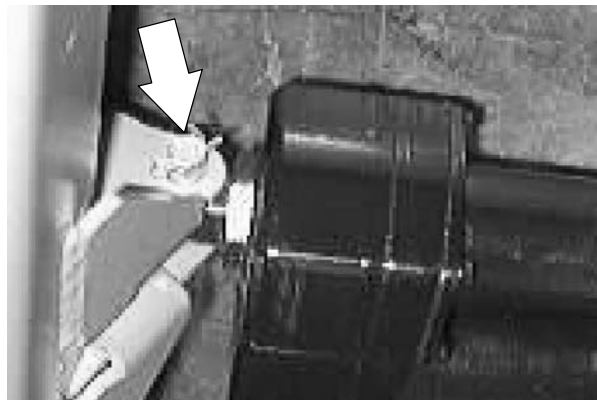

9. Reinstall the clevis pin and cotter pin into the end of the actuator where it attaches to the scrub head lift pivot bracket (*operators compartment*).



10. Reconnect the scrub head lift actuator to the main harness.

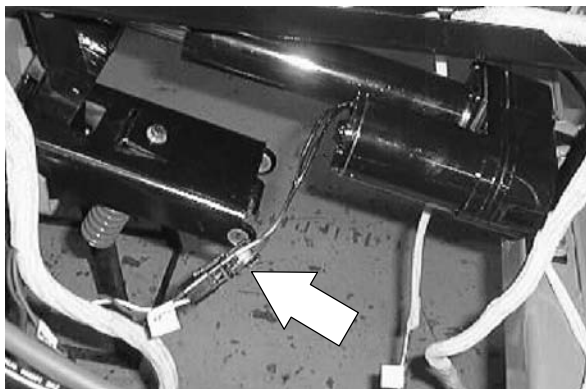

11. Operate the machine. Check the scrub head lift actuator for proper operation.

TO REPLACE “FAILED” SCRUB HEAD LIFT ACTUATOR

IF ACTUATOR FAILED WITH SCRUB HEAD IN THE RAISED POSITION:

(Top die spring compressed and actuator is extended)

1. Disconnect and remove the battery from the rear of the machine. This will allow access to the rear mount clevis on the scrub head lift actuator. Use a pry bar between the rear of the actuator and frame to release pressure on clevis pin. Remove the rear clevis pin. *(See TO REPLACE SCRUB HEAD LIFT ACTUATOR instructions and photos)*
2. Use a floor jack to lift the scrub head until both die springs on the lift assembly have minimal compression.
3. Remove the top roller between the lift tabs on the scrub head. *NOTE: The roller is under high forces. (See TO REPLACE SCRUB HEAD LIFT ACTUATOR instructions and photos)*

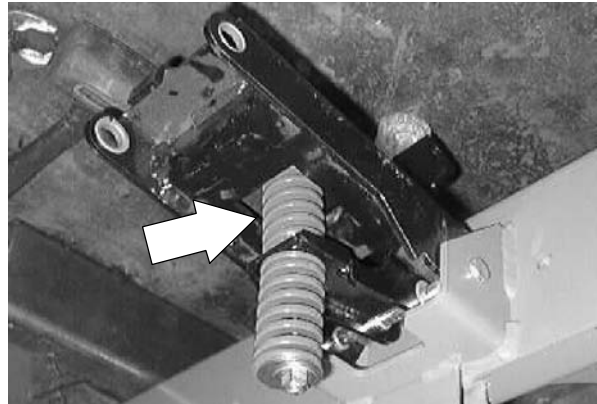

IF ACTUATOR FAILED WITH SCRUB HEAD IN THE LOWERED POSITION:

(Bottom die spring compressed and actuator is retracted)

1. Jack up the front of the machine until the scrub and brushes are off the floor and the pressure on the bottom die spring has been eliminated.
2. Go to step 3 in the TO REPLACE SCRUB HEAD LIFT ACTUATOR instructions.

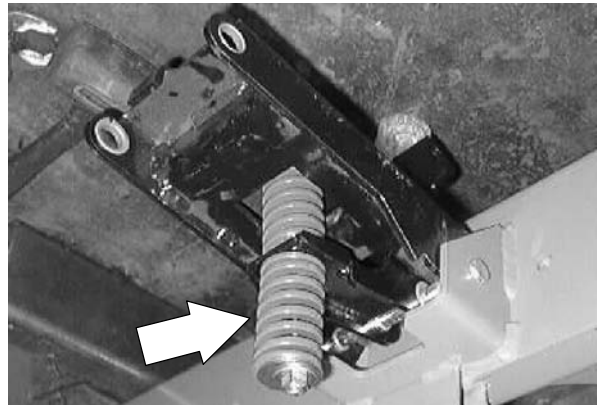

TO REPLACE REAR SQUEEGEE LIFT ACTUATOR

FOR SAFETY: Before Leaving Or Servicing Machine; Stop On Level Surface, Set Parking Brake.

1. Make sure the rear squeegee is in the raised position. Pull the vacuum hose out of the squeegee frame.

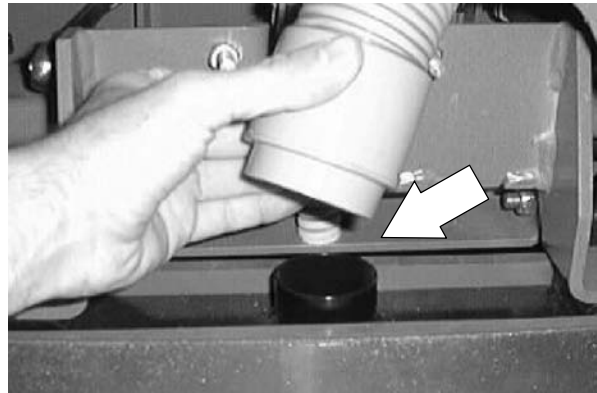

2. Loosen the hardware holding the squeegee frame to the lift assembly. Pull the squeegee frame and blade assembly off the machine.

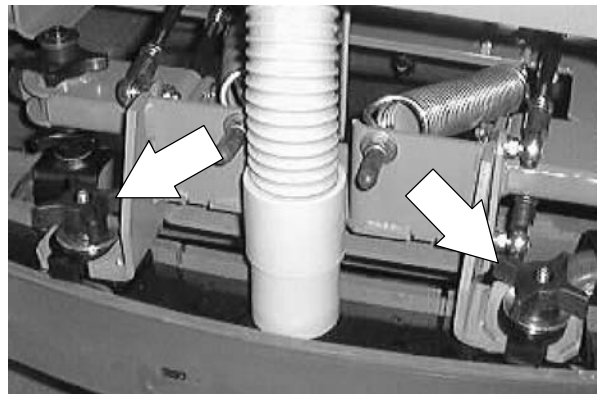

3. Remove the four hex screws holding the rear squeegee assembly to the machine frame.

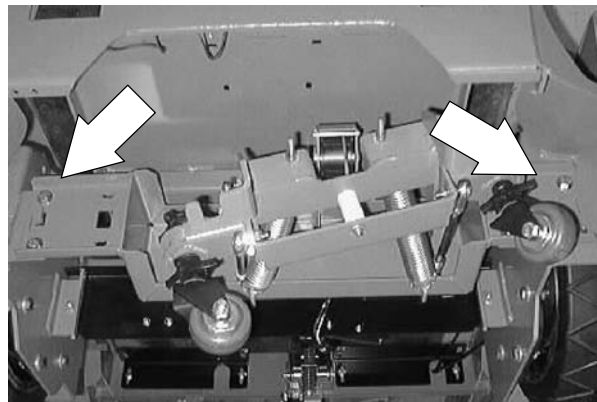

ELECTRICAL

4. Pull the squeegee assembly away from the rear of the machine.

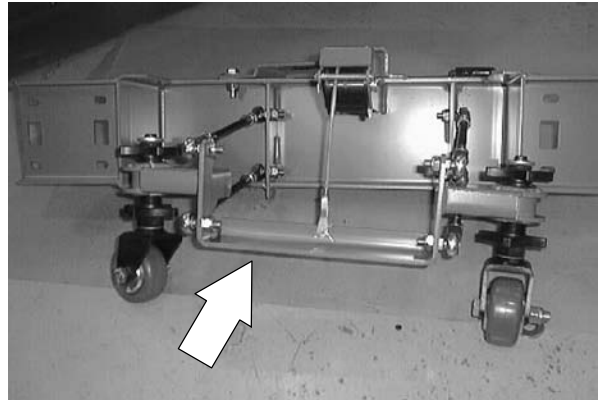

5. Disconnect the squeegee lift actuator from the main harness.

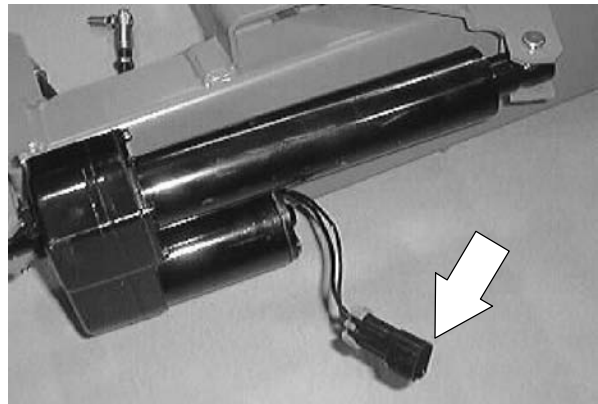

6. Remove the cotter pin and clevis pin from the motor end of the actuator where it attaches to the squeegee mount frame.

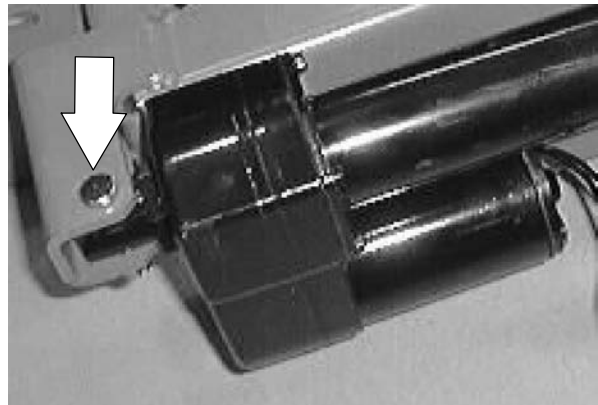

7. Remove the cotter pin and clevis pin from the rod end of the actuator where it attaches to the squeegee lift cable pivot bracket. Remove the actuator from the machine.

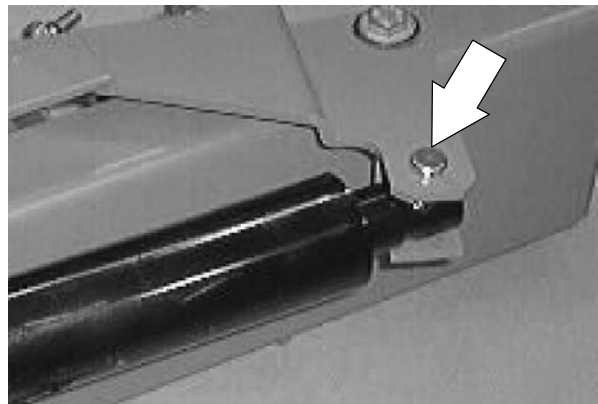

8. Position the new rear squeegee lift actuator onto the front of the squeegee mount frame.

NOTE: The motor faces down and to the right side of the machine.

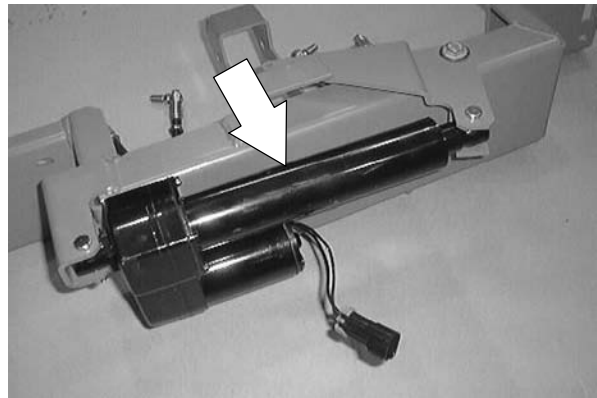

9. Reinstall the clevis pins and cotter pins into each end of the new actuator.

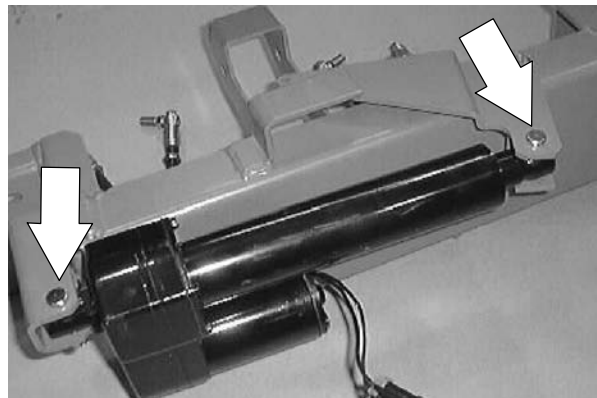

10. Position the squeegee assembly at the back of the machine. Reconnect the squeegee lift actuator to the main harness.

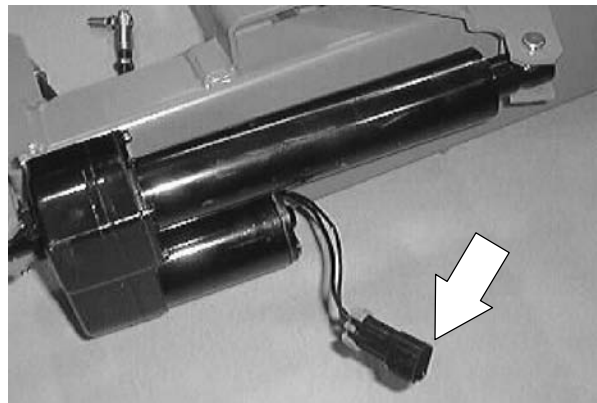

11. Position the squeegee assembly onto the back of the machine frame.

MAXPRO™ 1000: Use the left hand bolt pattern.

MAXPRO™ 1200: Use the right hand bolt pattern.

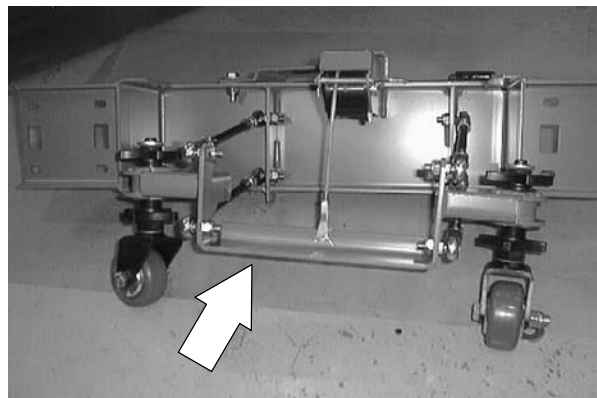

ELECTRICAL

12. Reinstall the hardware. Tighten to 37 - 48 Nm (26 - 34 ft lb).

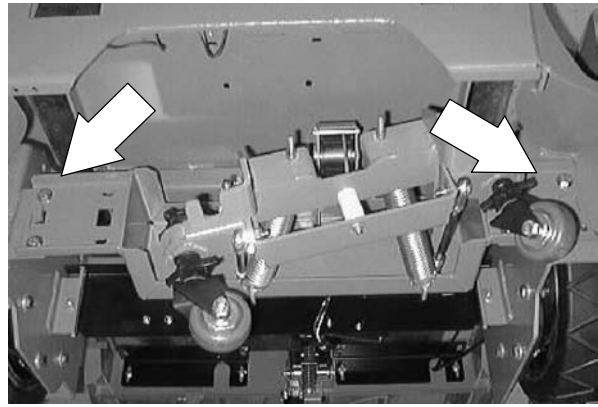

13. Reinstall the squeegee blade assembly frame onto the lift bracket. Position the vacuum hose into the hole in the squeegee frame.

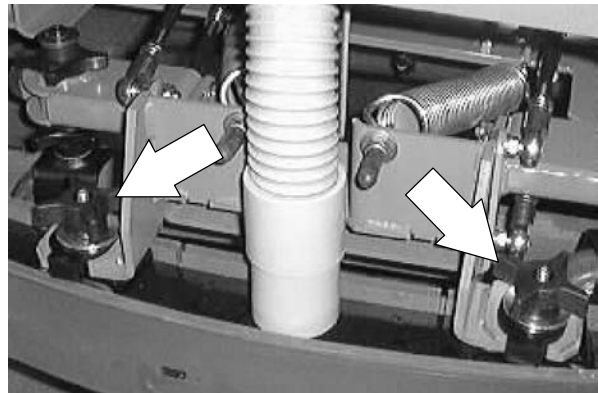

14. Operate the machine and check the squeegee assembly for proper operation.

TO REPLACE SIDE SHIFT ACTUATOR

FOR SAFETY: Before Leaving Or Servicing Machine; Stop On Level Surface, Set Parking Brake.

1. Make sure the scrub head is retracted in under the machine.



2. Go under the machine on the left side, under the recovery tank.



3. Locate the scrub head side shift actuator above the front of the scrub head.

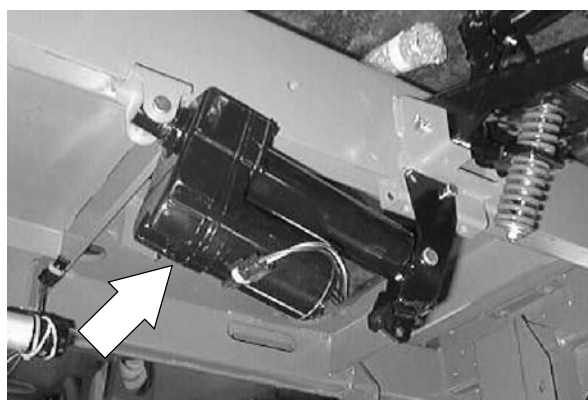

ELECTRICAL

4. Disconnect the side shift actuator from the main harness.

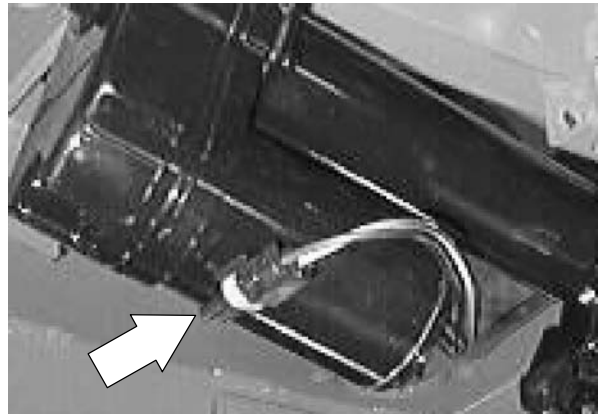

5. Remove the cotter pin and clevis pin from the end of the actuator where it attaches to the pivot bracket.

NOTE: Disconnect one end of the gas spring to release pressure on clevis pin.



6. Remove the cotter pin and clevis pin from the end of the actuator where it attaches to the machine frame. Remove the actuator from the machine.

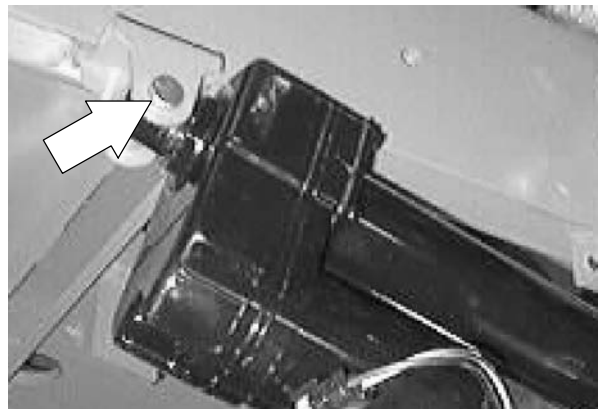

7. Position the new actuator in the machine. Reinstall the two clevis pins and cotter pins.

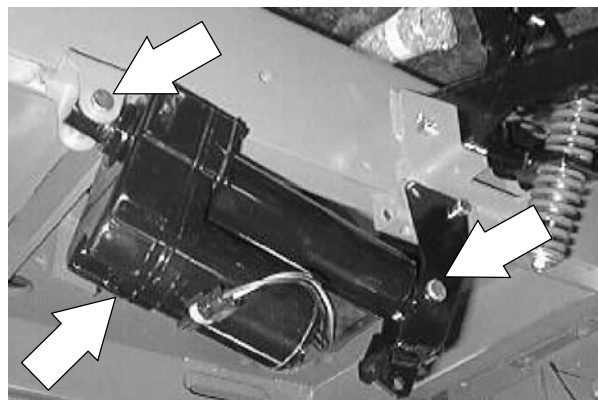

8. Reconnect the side shift actuator to the main harness.

9. Operate the machine and check the side shift actuator for proper operation.

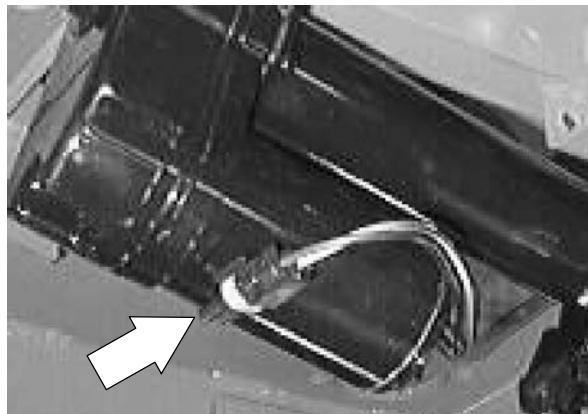

ES™ PUMP

The ES™ pump is used to pump filtered solution from the recovery tank to the solution tank.

TO REPLACE ES™ PUMP

FOR SAFETY: Before Leaving Or Servicing Machine; Stop On Level Surface, Set Parking Brake.

1. Drain the recovery tank and lower the scrub head. Shut off the machine.



2. Go under the machine on the right side and locate the ES™ pump on the mount bracket between the back wheels.

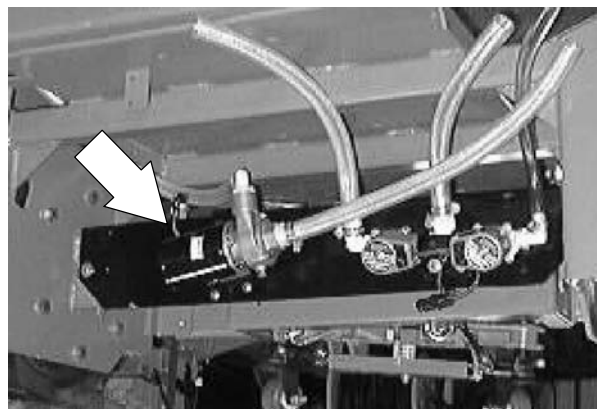

3. Disconnect the ES™ pump from the main harness.

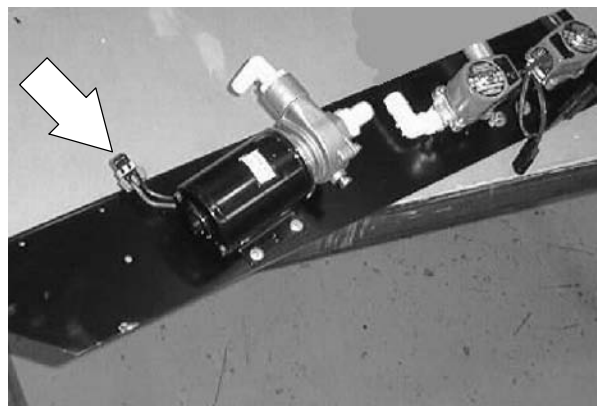

4. Loosen the wormdrive clamp holding the recovery tank hose to the ES™ pump center fitting. Pull the hose off the fitting.

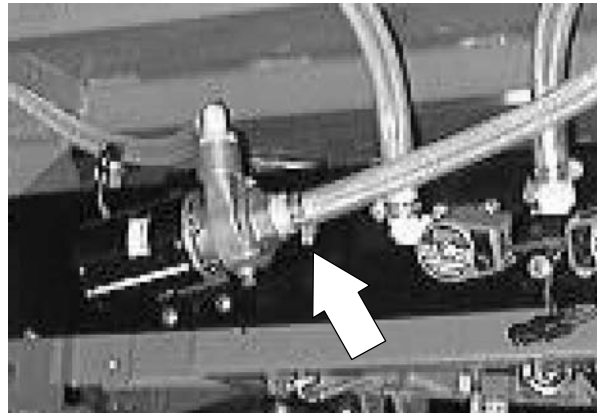

5. Loosen the wormdrive clamp holding the solution tank hose to the ES™ pump top fitting. Pull the hose off the fitting.

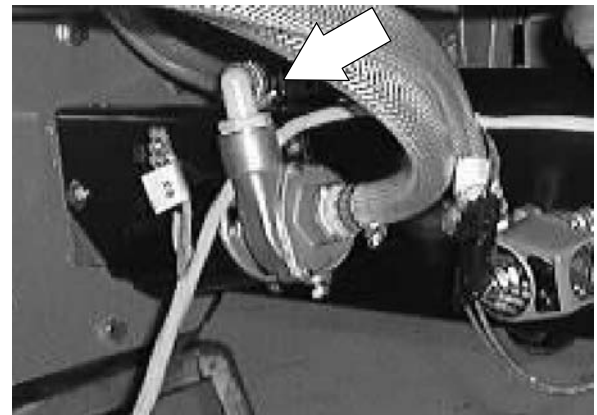

6. Remove the four hex screws holding the ES™ pump to the mount bracket. Remove the ES™ pump from the machine.



7. Remove the fittings from the existing ES™ pump. Install fittings in the new pump in the same orientation as they were removed.

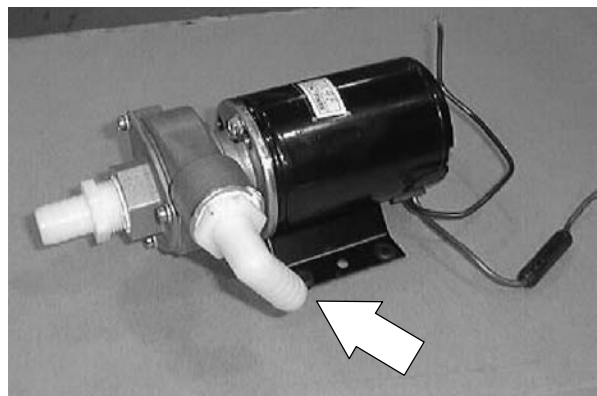

ELECTRICAL

8. Reinstall the four hex screws holding the ES™ pump to the mount bracket. Hand tighten tight.

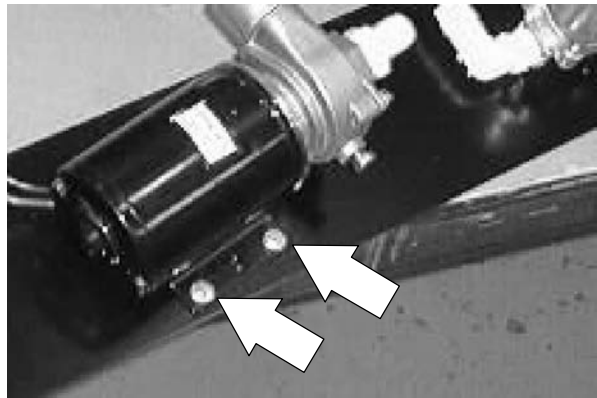

9. Reinstall the solution tank hose onto the upper fitting on the ES™ pump. Tighten the wormdrive clamp.

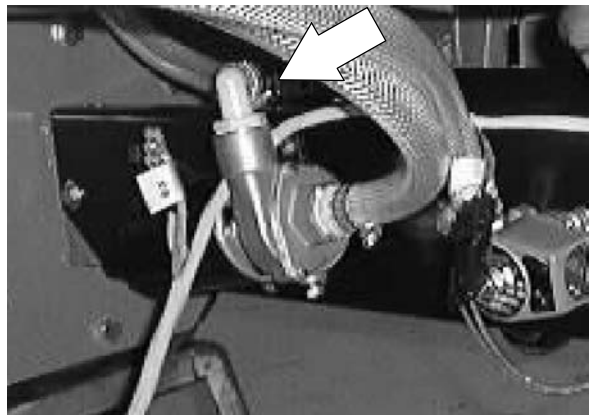

10. Reinstall the recovery tank hose onto the lower fitting on the ES™ pump. Tighten the wormdrive clamp.

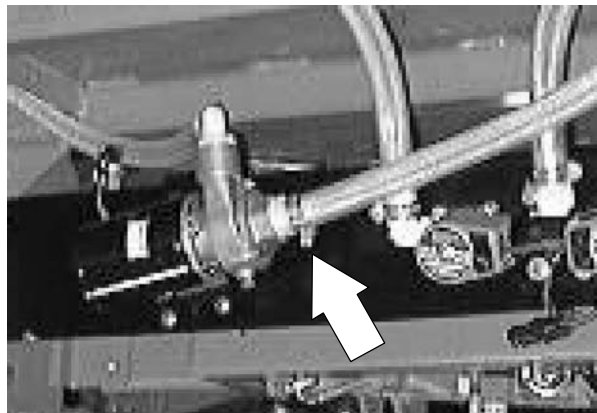

11. Reconnect the ES™ pump to the main harness.

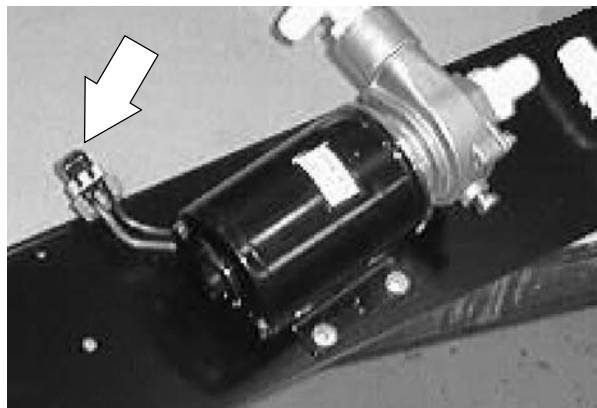

12. Operate the machine and check the new ES™ pump for proper operation.

DETERGENT PUMP

The detergent pump is used to pump detergent to the scrub head during the scrubbing operation.

TO REPLACE DETERGENT PUMP

FOR SAFETY: Before Leaving Or Servicing Machine; Stop On Level Surface, Set Parking Brake.

1. Start the machine and lower the scrub head. Shut off the machine.



2. Go under the machine on the left side, under the recovery tank.



3. Locate the detergent pump on the left hand frame leg.

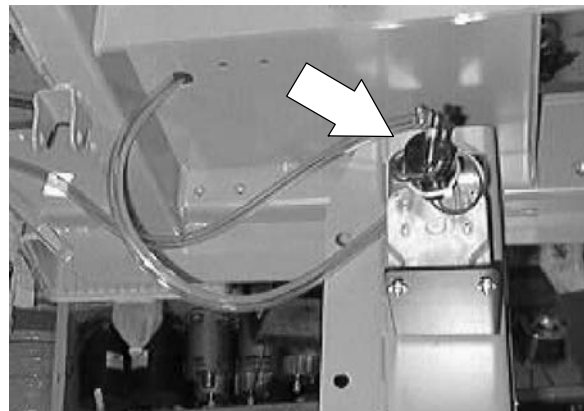

ELECTRICAL

4. Disconnect the detergent pump from the main harness.

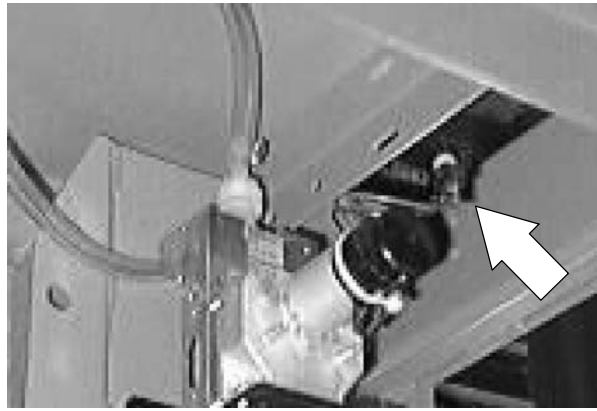

5. Mark and disconnect the two hoses leading to the top of the detergent pump.

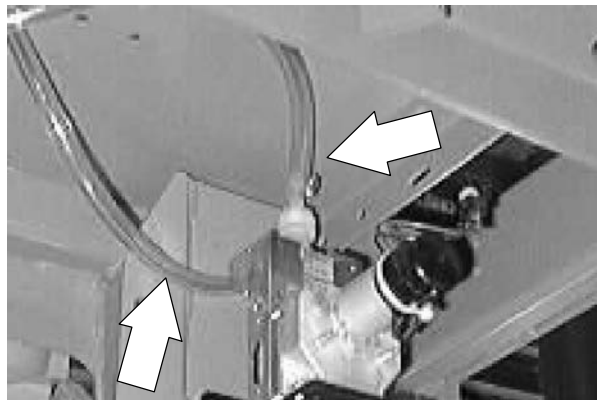

6. Remove the two hex screws holding the detergent pump to the mount bracket. Remove the pump from the machine.

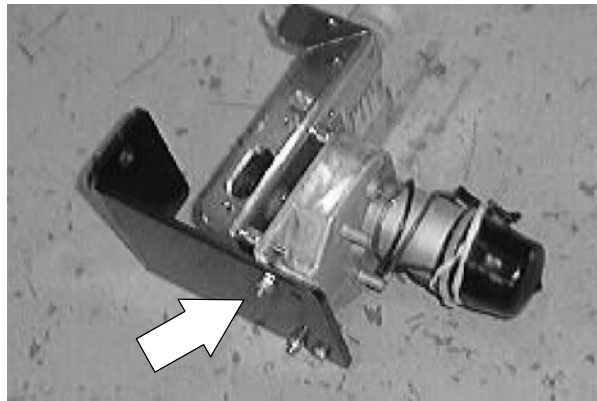

7. Position the new detergent pump on the mount bracket. Reinstall the two screws and tighten.

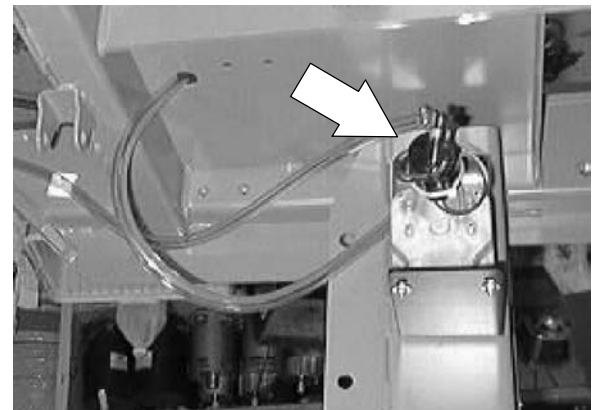

8. Reconnect the two hoses leading to the top of the detergent pump.

NOTE: Make sure the hose leading from the detergent tank is attached to the top fitting.

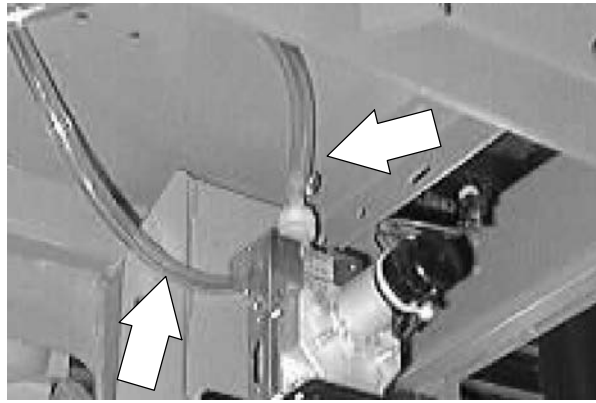

9. Reconnect the detergent pump to the main harness.



10. Operate the machine and check the new detergent pump for proper operation.

ELECTRICAL

TO REPLACE AUTO FILL VALVES

FOR SAFETY: Before Leaving Or Servicing Machine; Stop On Level Surface, Set Parking Brake.

1. Drain the solution and recovery tanks.



2. Start the machine and lower the scrub head. Shut off the machine.



3. Go under the machine on the left side, under the recovery tank, ahead of the left, rear wheel.



4. Locate the autofill valves on the mount bracket between the rear wheels.

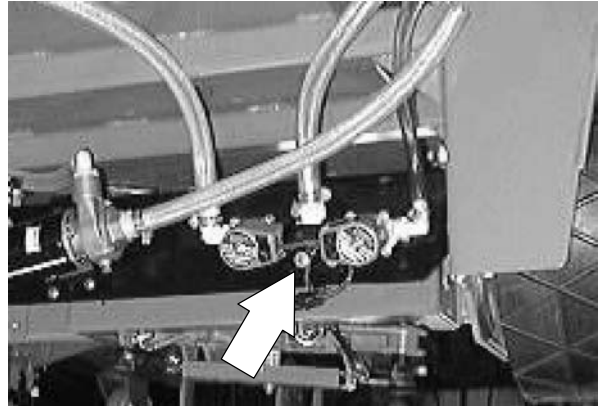

5. Disconnect the valve solenoids from the main harness.

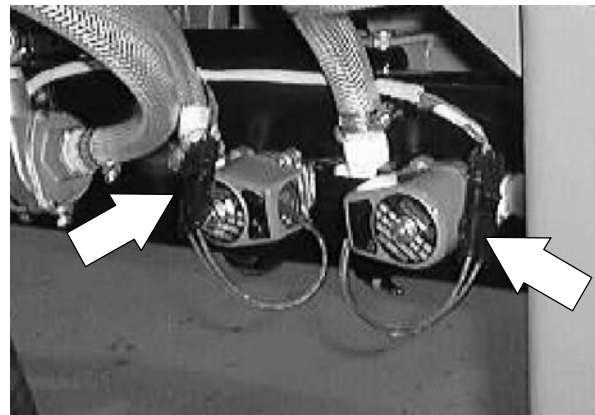

6. Mark and disconnect the three hoses leading to the autofill valve assembly.

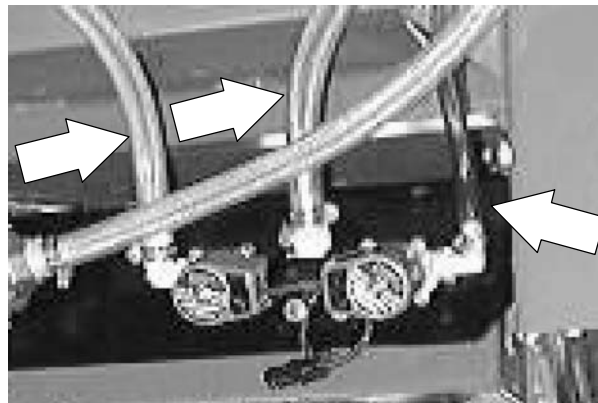

7. Remove the three screws holding the autofill valve assembly retainer bracket to the pump mount bracket. Remove the assembly from the machine.

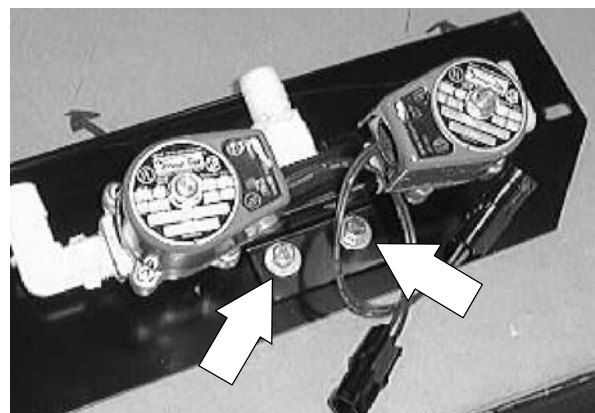

ELECTRICAL

8. Remove the fitting from the autofill valve.

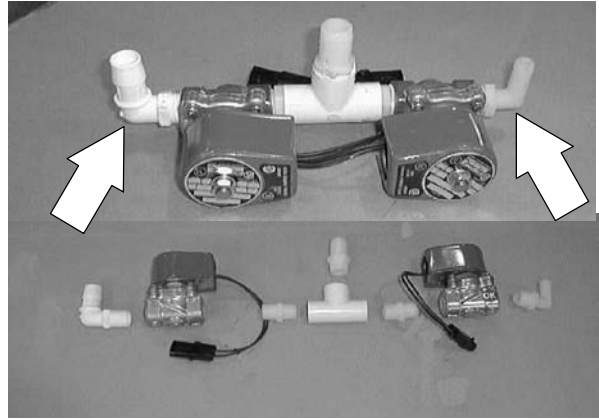

9. Remove the autofill valve from the plastic tee fitting.

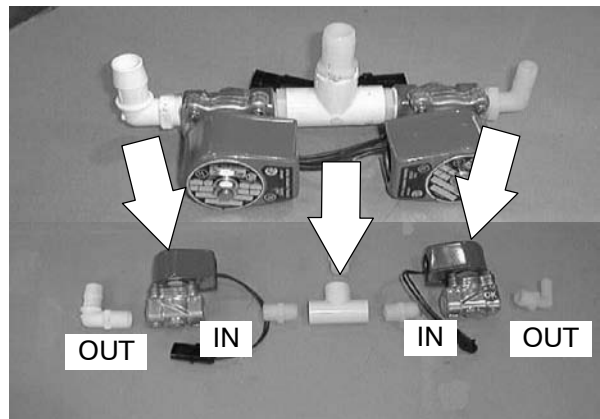

10. If replacing left hand autofill valve--note orientation of valve and fittings.

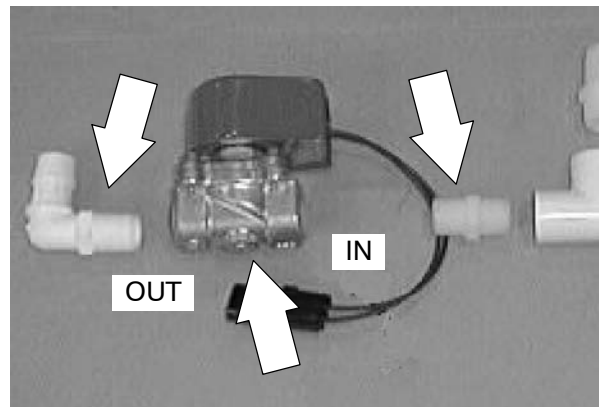

11. If replacing right hand autofill valve--note orientation of valve and fittings.

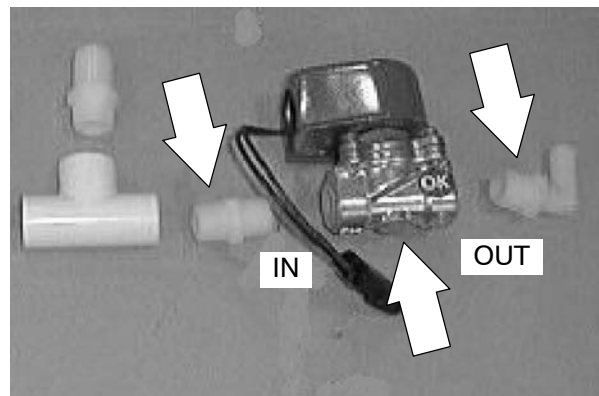

12. Reinstall the autofill valve assembly and retainer bracket onto the pump mount bracket. Reinstall the three hex screws and tighten to 11 - 14 Nm (7 - 10 ft lb).

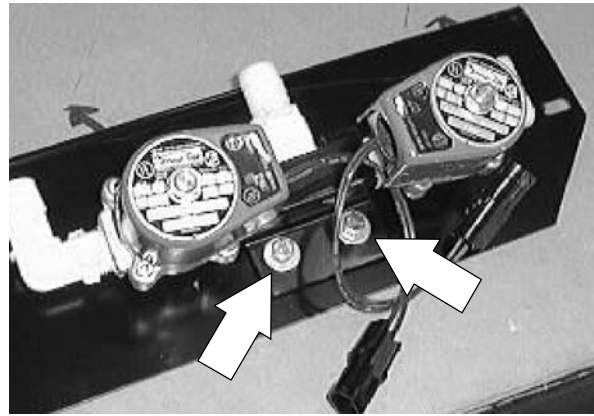

13. Reconnect the three hoses to the autofill valve assembly.

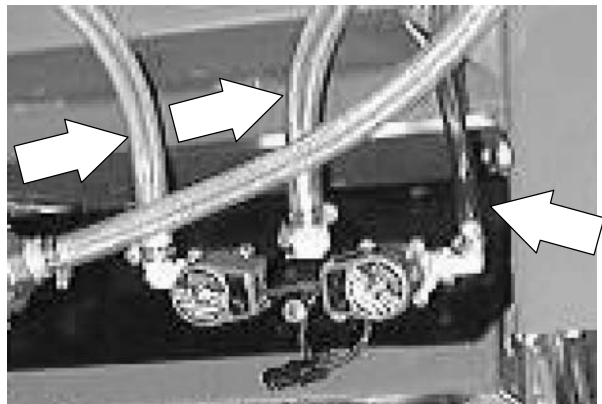

14. Reconnect the valve solenoids to the main harness.

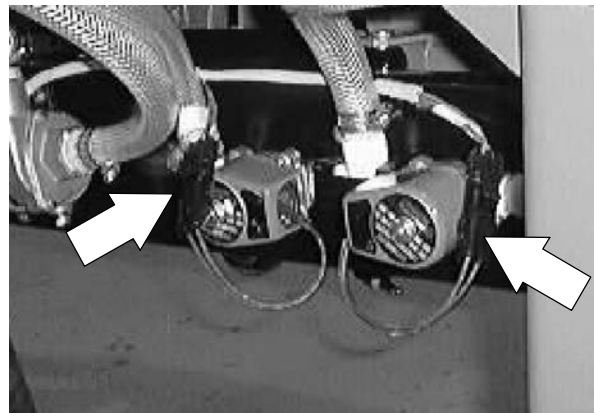

15. Operate the machine and check the new autofill valve for proper operation.

TO REPLACE SOLUTION SOLENOID VALVE

FOR SAFETY: Before Leaving Or Servicing Machine; Stop On Level Surface, Set Parking Brake.

1. Drain the solution and recovery tanks.



2. Start the machine and lower the scrub head. Shut off the machine.



3. Go under the machine on the left side, under the recovery tank, ahead of the left, rear wheel.



4. Locate the solution solenoid valve in the center, front area of the scrub head.

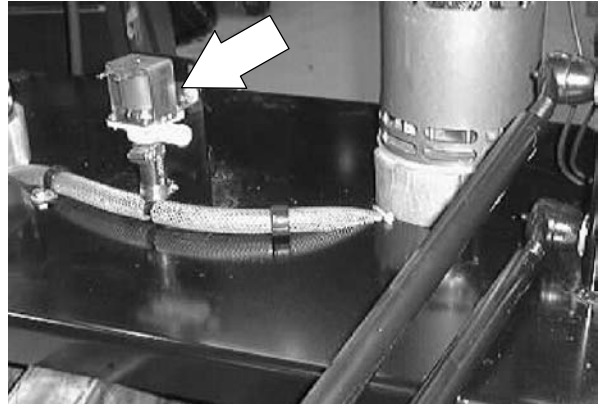

5. Disconnect the solenoid valve from the main harness.

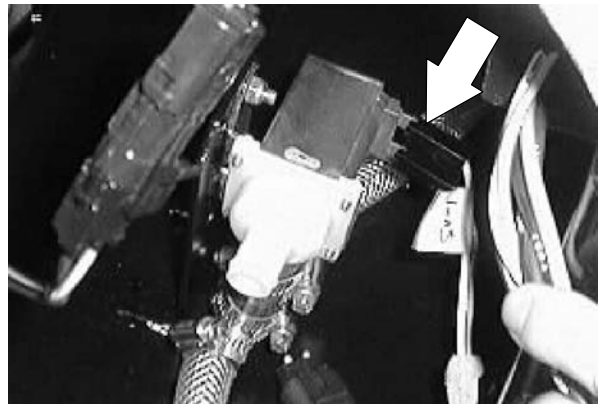

6. Loosen the worm drive clamps and remove the water lines leading to the solenoid valve.

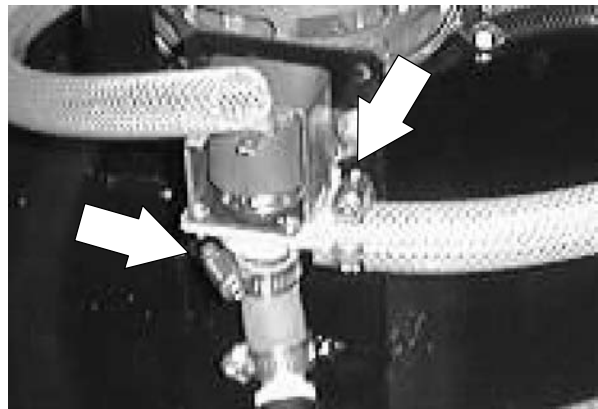

7. Remove the two screws holding the solenoid valve to the mount bracket. Remove the solenoid valve from the machine.



ELECTRICAL

8. Install the new solenoid valve on the scrub head. Reinstall the two hex screws and tighten to 11 - 14 Nm (7 - 10 ft lb).

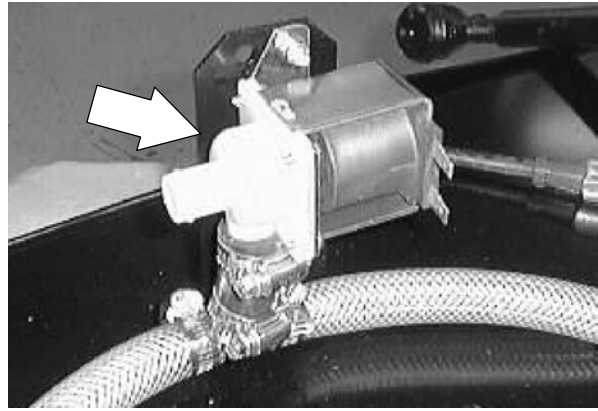

9. Connect the new valve to the main harness.

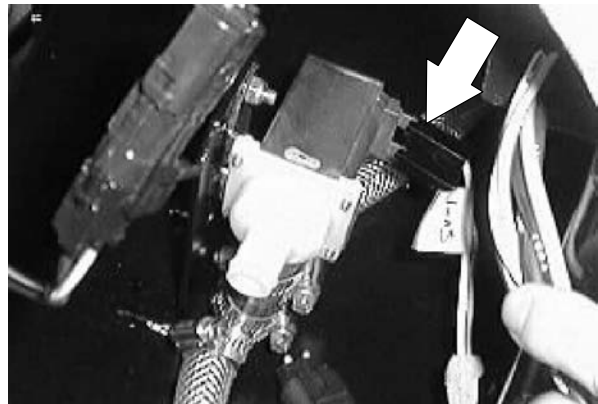

10. Position the two water lines onto the new solenoid valve. Tighten the wormdrive clamps.

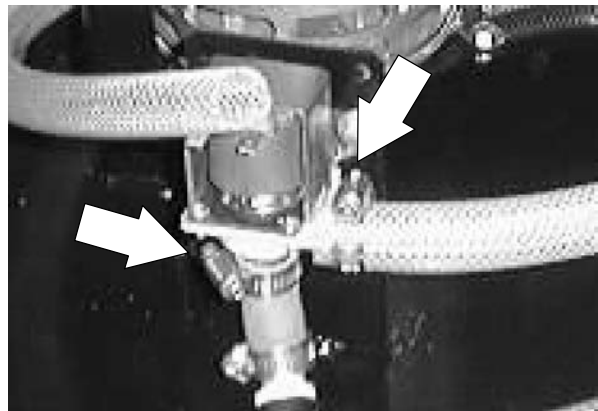

11. Operate the machine and check the new solution solenoid valve for proper operation.

TO REPLACE SWEEPER VACUUM FAN MOTOR

FOR SAFETY: Before Leaving Or Servicing Machine; Stop On Level Surface, Set Parking Brake.

1. Raise the rear cover and unplug the battery connector.

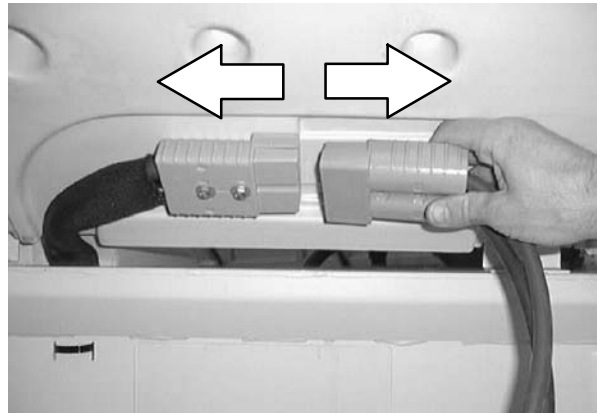

2. Open the top cover and side door.



3. Remove the hopper cover, debris filter, and access panel.



ELECTRICAL

4. Disconnect the vacuum fan motor from the main harness.

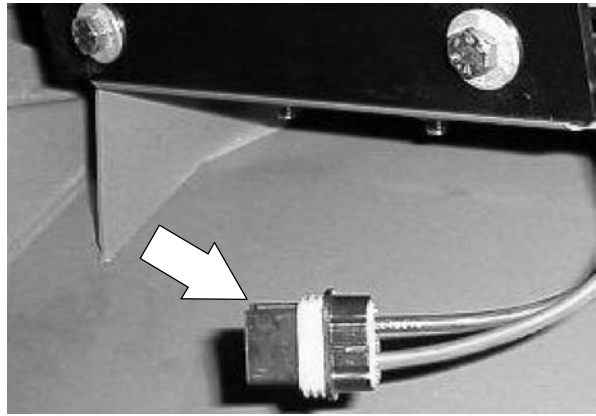

5. Loosen the three hex screws holding the vacuum fan motor plate to the vacuum housing mount.

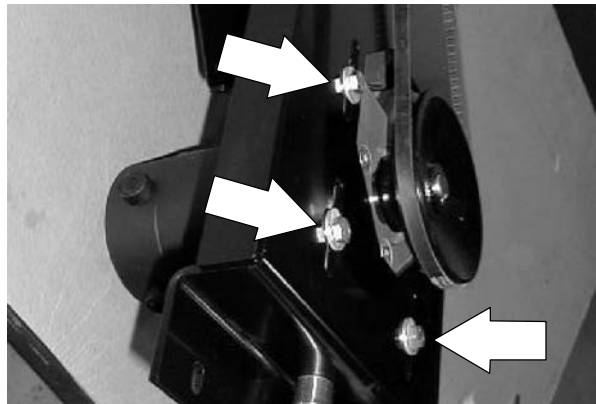

6. Loosen, then remove the belt adjustment screw on the bottom of the vacuum fan assembly mount bracket. *This will give slack to the V-belt.*

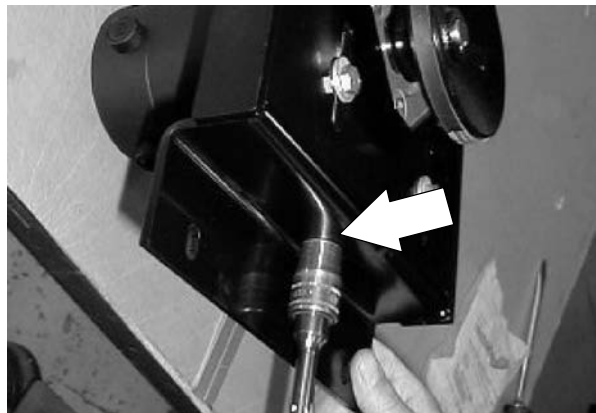

7. Remove the V-belt from the motor sheave.

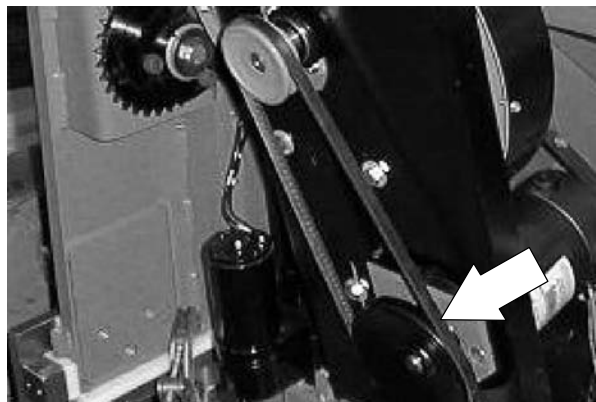

8. Finish removing the three hex screws holding the vacuum fan motor plate to the vacuum housing mount.

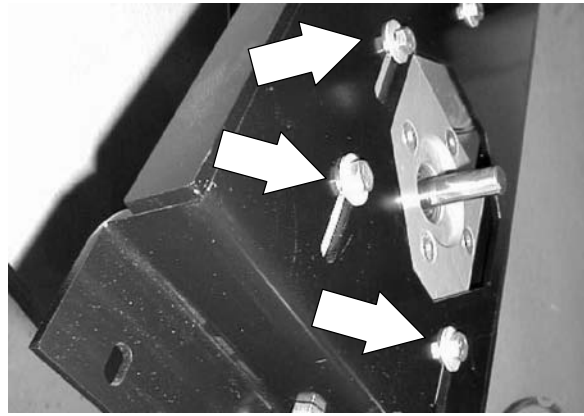

9. Remove the vacuum fan motor and mount plate out the front of the hopper opening.

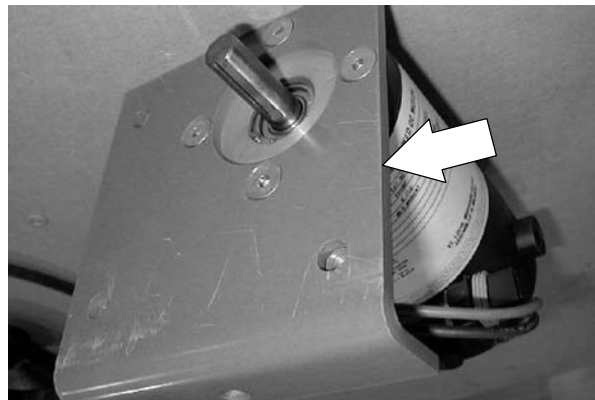

10. Loosen the two set screws holding the V-belt sheave to the motor shaft. Pull the sheave off the motor shaft.



11. Remove the four flat screws holding the vacuum fan motor to the angle mount plate. Remove the motor from the plate.

NOTE: Note the orientation of the motor to the plate.

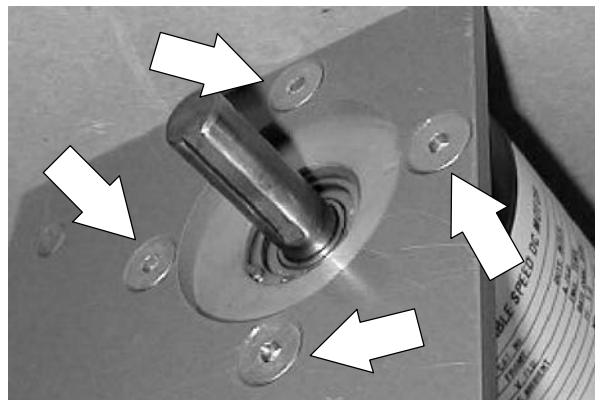

ELECTRICAL

12. Install the new vacuum fan motor onto the angle bracket. Reinstall the four flat screws and tighten to 18 - 24 Nm (15 - 20 ft lb).

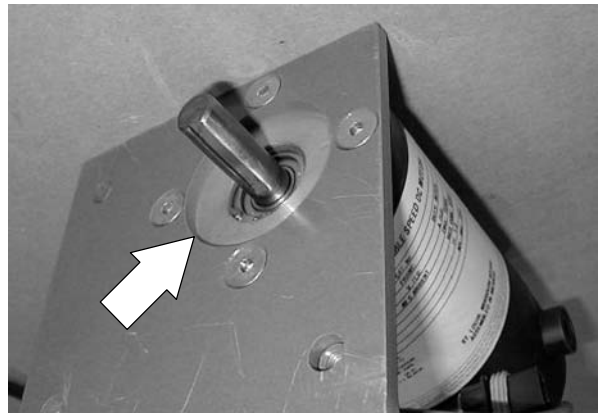

13. Reinstall the sheave onto the new vacuum fan motor. Make sure the shaft key is in place. *Leave the set screws loose for now.*



14. Position the motor assembly onto the vacuum fan mount plate. *Come in through the front of the hopper and access panel area.*

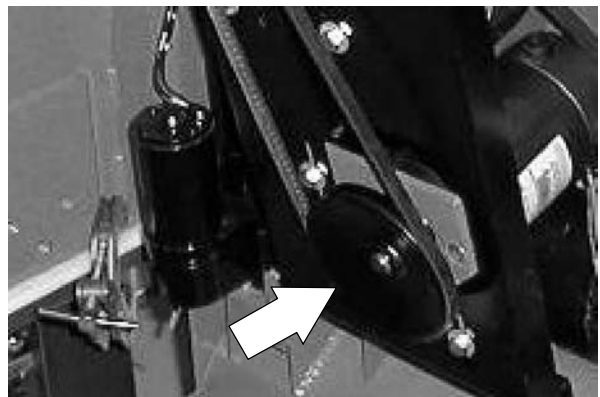

15. Install the three hex screws holding the motor assembly to the mount plate. *Just snug the hex screws for now.*

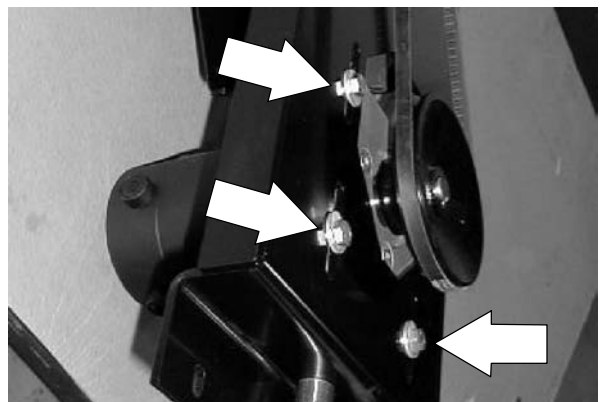

16. Use a straight edge to line up the sheave on the new vacuum fan motor with the sheave on the vacuum fan impeller shaft.

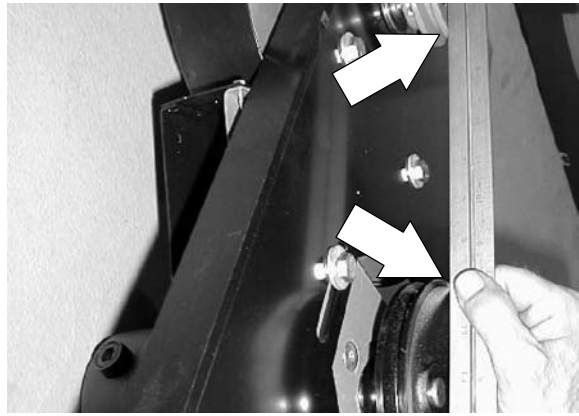

17. Tighten the two sets screws on the motor sheave. *Hand tighten tight.*

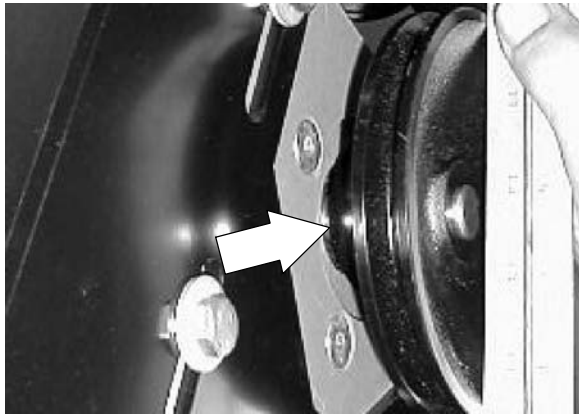

18. Install the belt adjustment hex screw into the bottom of the motor mount angle bracket. *Leave loose for now.*

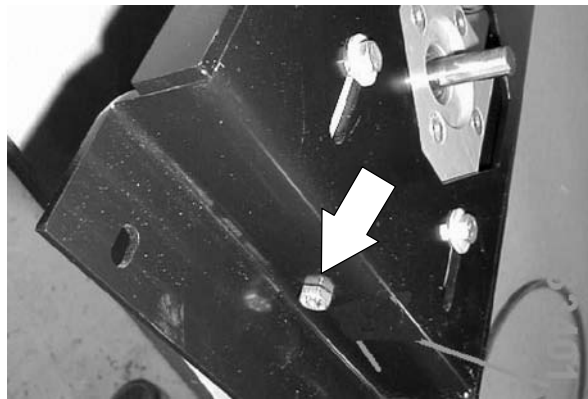

19. Position the V-belt over the two sheaves.

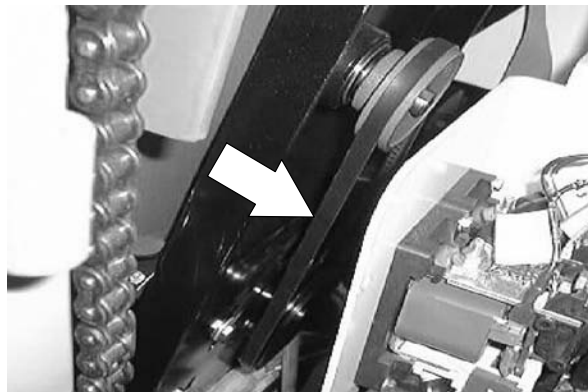

ELECTRICAL

20. Make sure the three motor hex screws are loose. Use the bottom adjustment hex screw to pull down on the motor mount plate and tighten the V-belt. *Tighten the bolt until the V-belt is tensioned properly. The deflection should be 3 to 7mm (0.125 to 0.25 in) when a force of 2.3 kg (5 lb) is applied at the belt midpoint.*

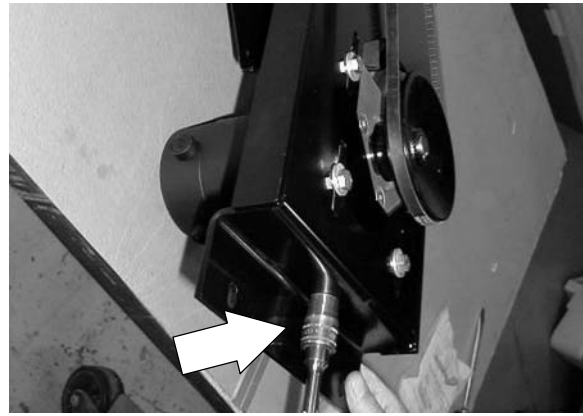

21. Tighten the three motor mount screws to 18 - 24 Nm (15 - 20 ft lb).

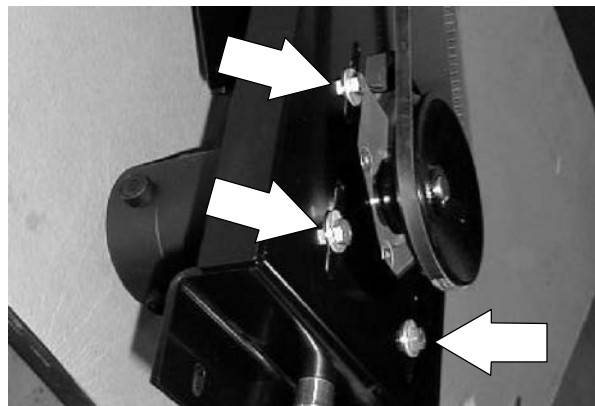

22. Plug the new motor into the main harness.

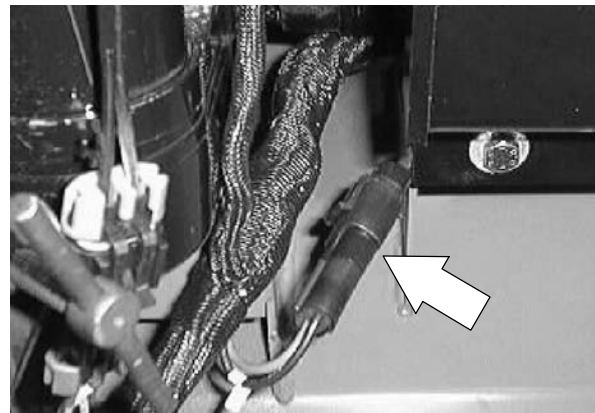

23. Reinstall the access panel, debris filter, and hopper cover.



24. Reconnect the battery.

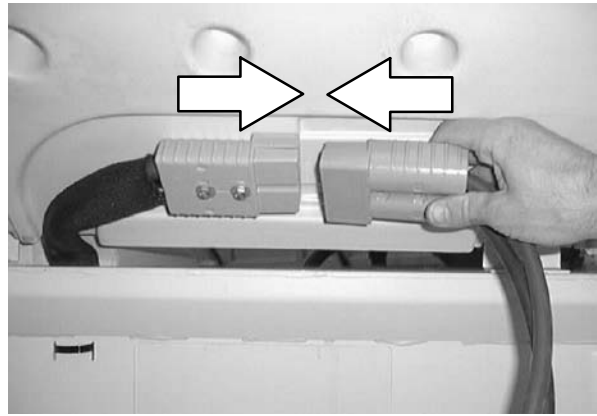

25. Operate the machine. Check the new vacuum fan motor for proper operation.

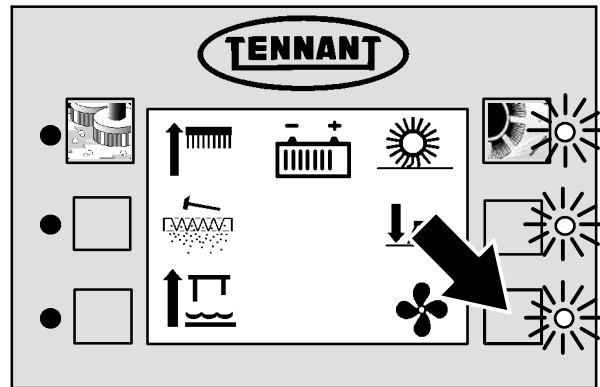

26. Close the top cover and side door.

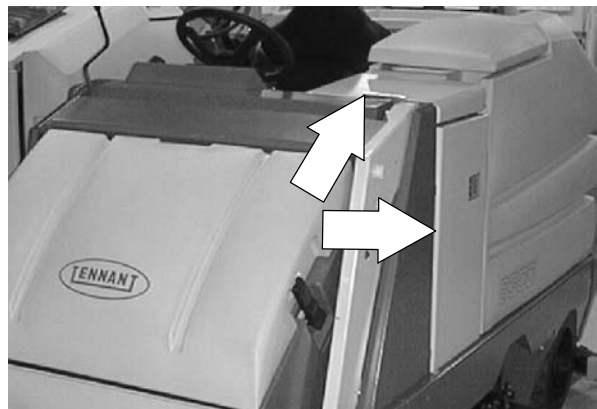

ELECTRICAL

TO REPLACE SWEEPER MAIN BRUSH MOTOR

FOR SAFETY: Before Leaving Or Servicing Machine; Stop On Level Surface, Set Parking Brake.

1. Raise the rear cover and unplug the battery connector.

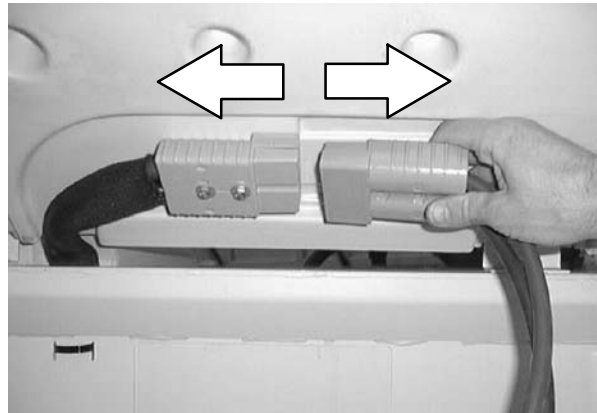

2. Remove the left hand sweep brush door.



3. Locate the main brush motor at the back side of the sweeper frame.

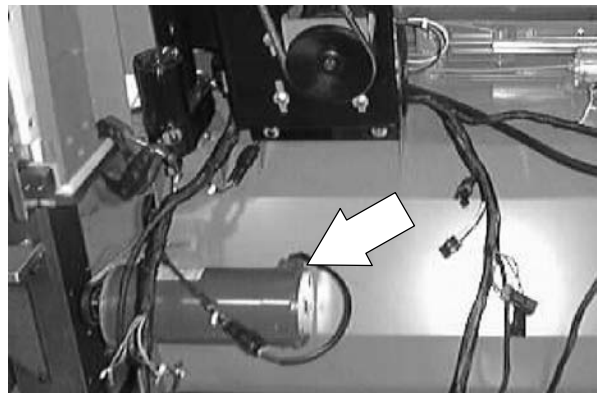

4. Disconnect the main sweep brush motor from the main harness.

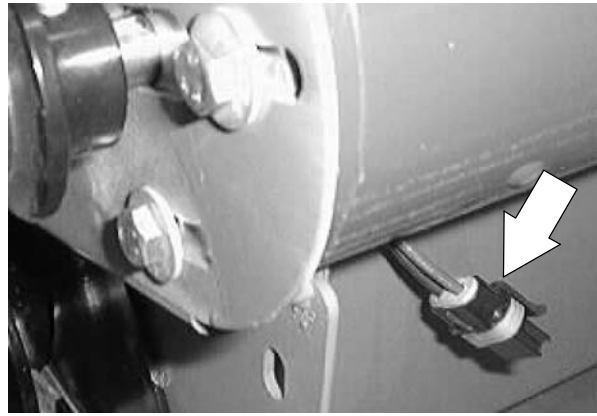

5. Loosen the four hex screws holding the main brush motor to the sweeper frame.

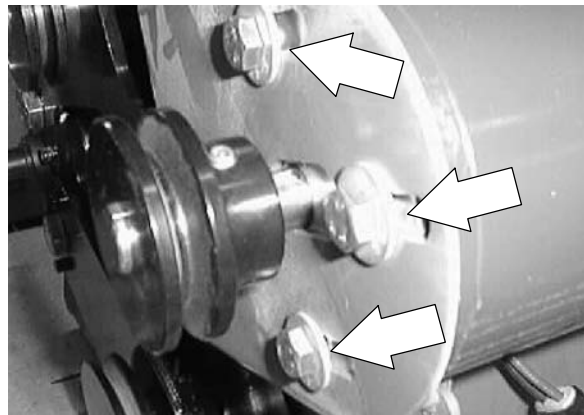

6. Push the main brush motor forward.
Remove the V-belt from the motor sheave.

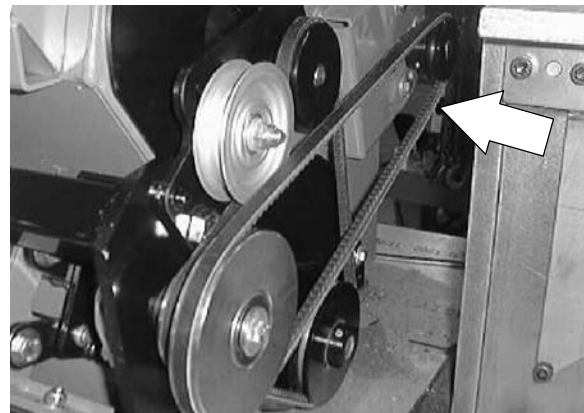

7. Finish removing the four mount screws.
Remove the motor out the bottom of the machine.

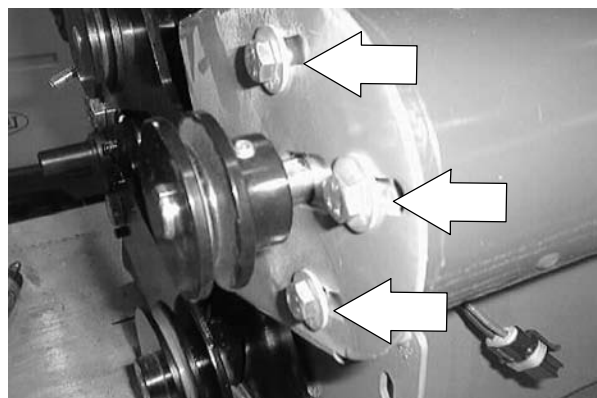

ELECTRICAL

- Loosen the set screws holding the sheave to the motor. Pull the sheave off the shaft.

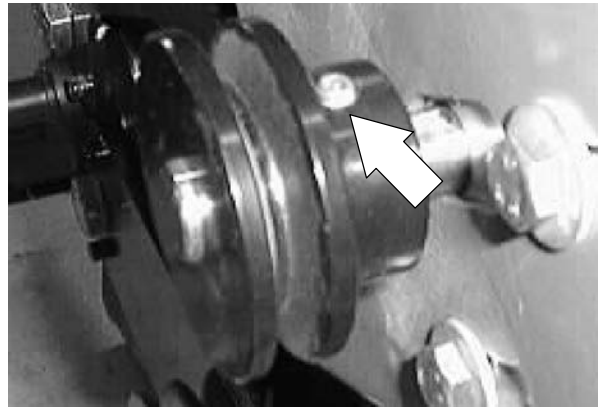

- Install the V-belt sheave onto the shaft of the new main brush motor. *Leave the set screws loose for now.*

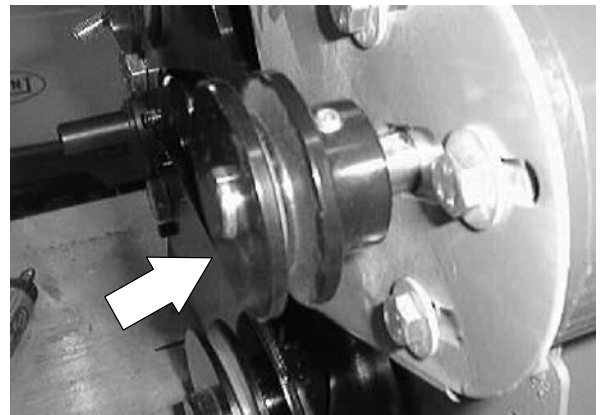

- Install the new main brush motor into the machine. *Go in from under the left side of the machine.*

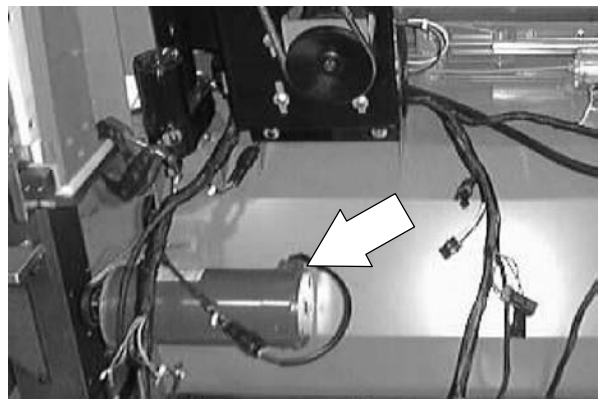

- Position the new motor onto the mount bracket. Reinstall the four hex screws *snug only.*

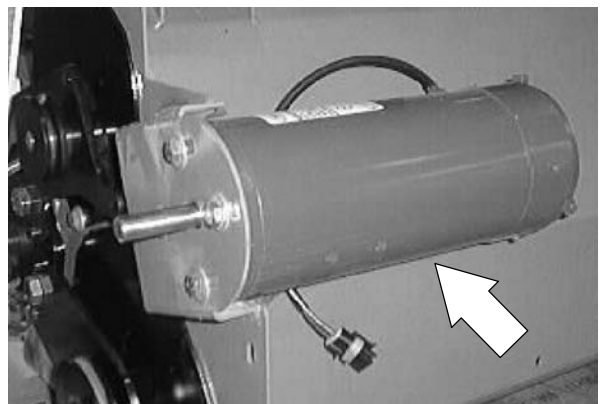

12. Use a straight edge to line up the sheave on the new sweep main brush motor and the larger sheave on the front of the pulley assembly.

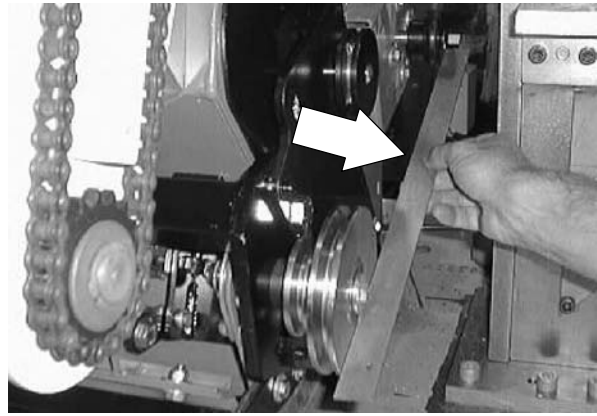

13. Tighten the sheave set screws tight.



14. Position the V-belt onto the motor sheave.

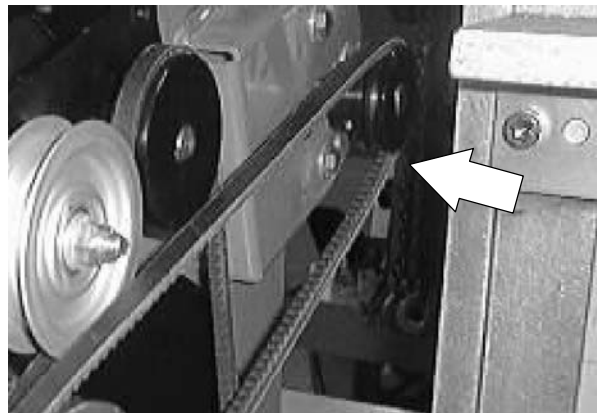

15. Pull back on the new motor until the V-belt is tight. *The deflection should be 3 to 7mm (0.125 to 0.25 in) when a force of 2.3 kg (5 lb) is applied at the belt midpoint.*

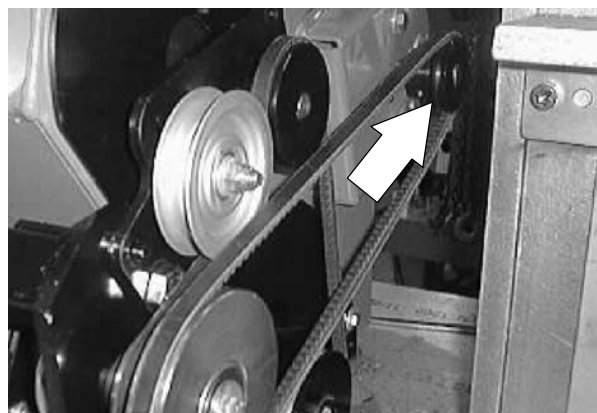

ELECTRICAL

16. Tighten the four motor mount screws to 18 - 24 Nm (15 - 20 ft lb).

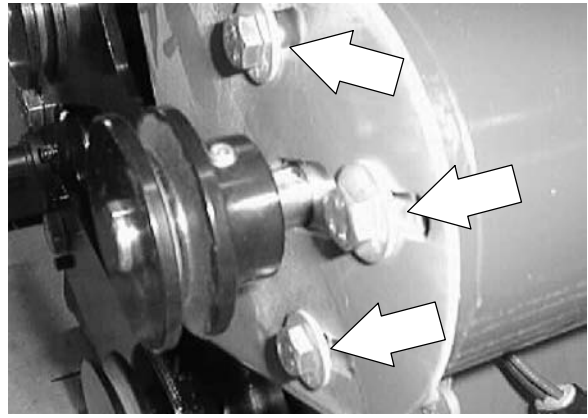

17. Connect the new motor to the main harness.

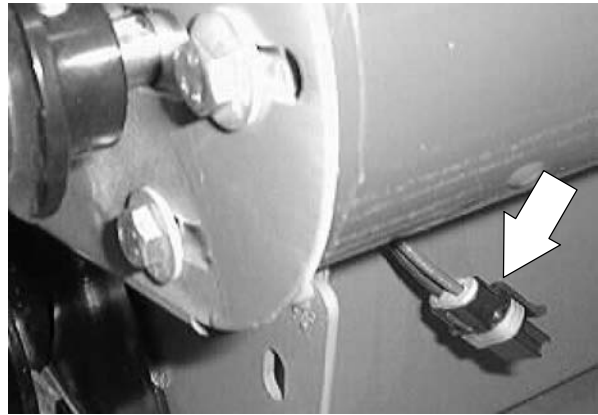

18. Reinstall or close the left side brush door.

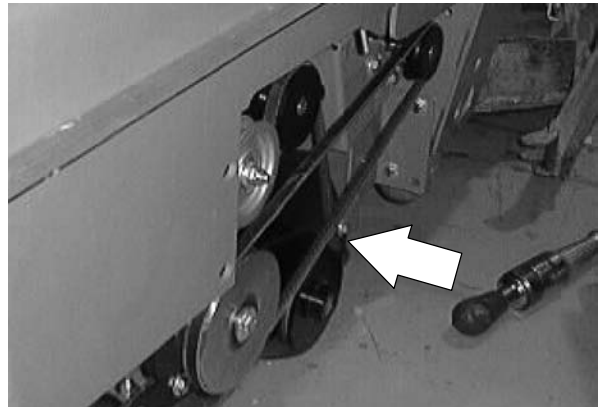

19. Reconnect the battery.

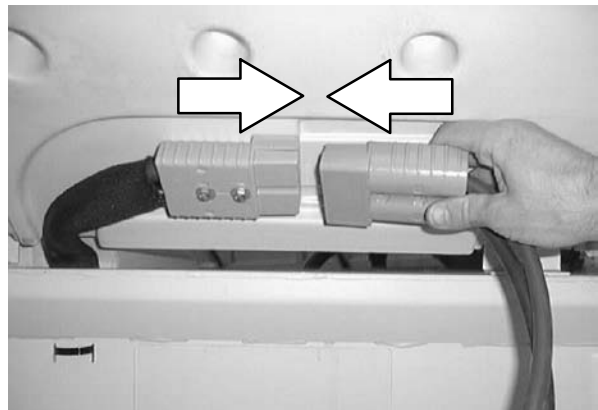

20. Operate the machine. Check the new sweep main brush motor for proper operation.

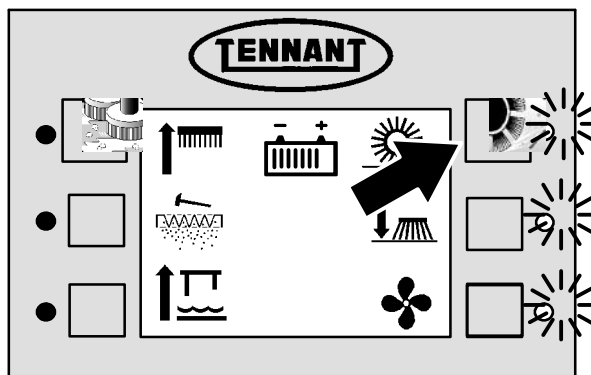

TO REPLACE SWEEPER SIDE BRUSH MOTOR

FOR SAFETY: Before Leaving Or Servicing Machine; Stop On Level Surface, Set Parking Brake.

1. Remove the side brush from the brush motor assembly.

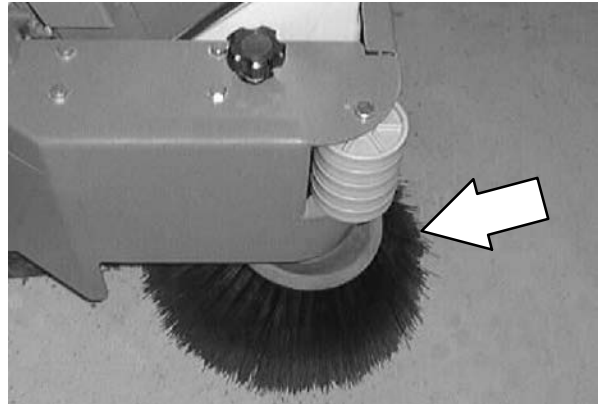

2. Disconnect the side brush motor from the main harness.

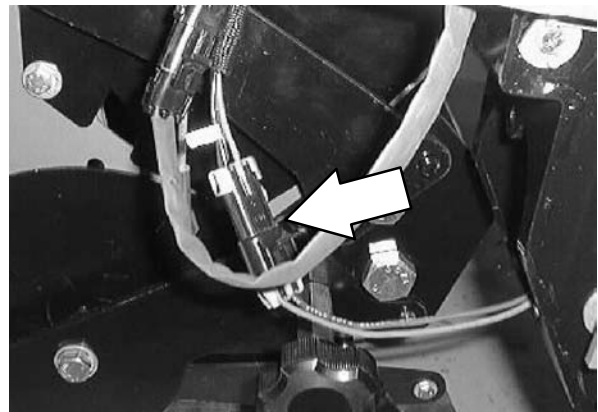

3. Remove the four hex screws holding the side brush motor assembly and brush guard to the mount bracket.



4. Pull the side brush motor assembly and guard off of the mount bracket. *Note the orientation of the brush motor assembly in the guard opening.*

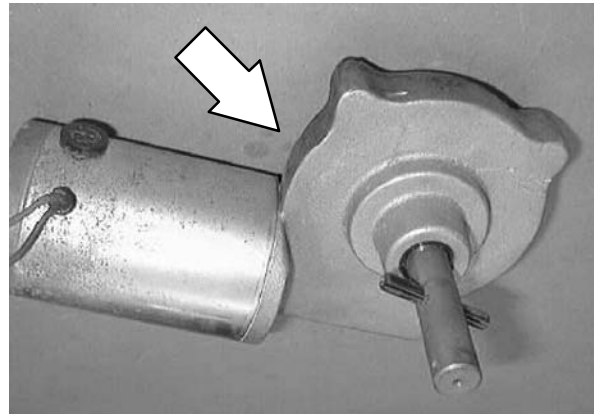

5. Position the new side brush motor into the opening of the side brush guard.

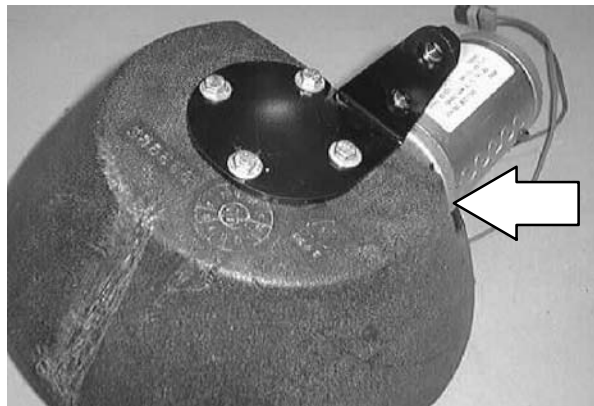

6. Position the guard and motor onto the bottom of the mount bracket. Align the holes in the guard and motor with the holes in the mount bracket. Reinstall the hardware and tighten to 8 - 10 Nm (6 - 8 ft lb).

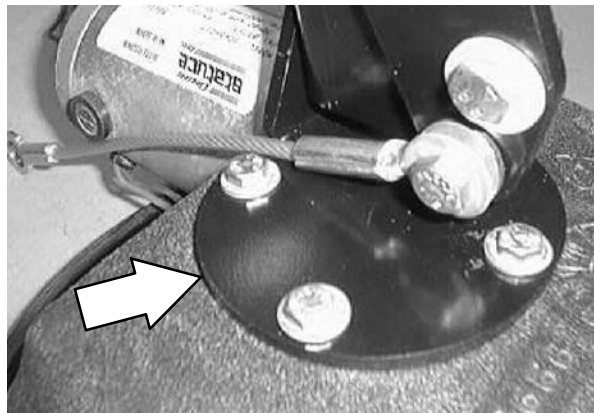

7. Connect the new side brush motor to the main harness.

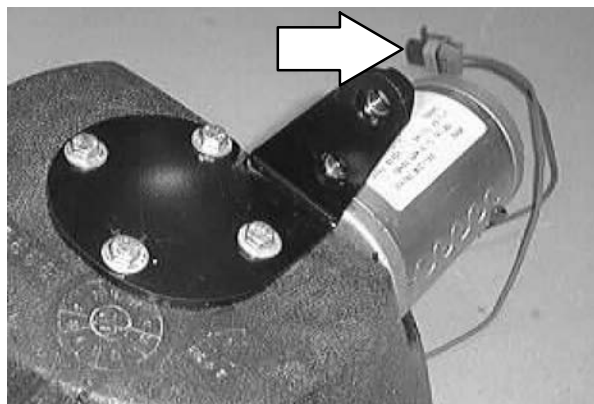

ELECTRICAL

8. Reinstall the side brush.

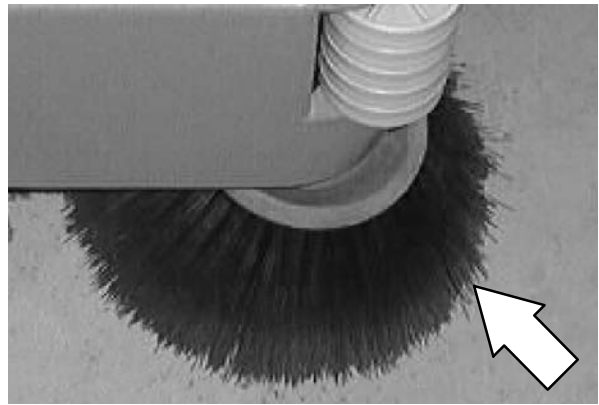

9. Operate the machine. Check the side brush for proper operation.

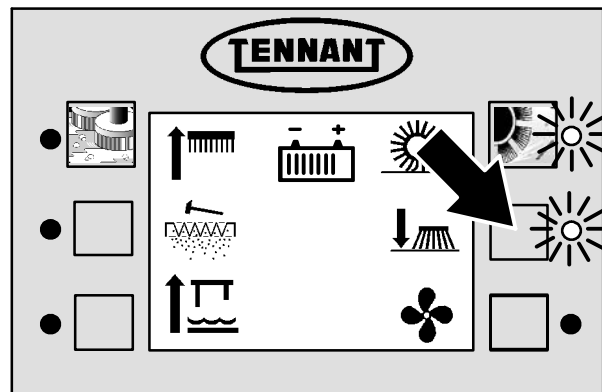

TO REPLACE HOPPER ROLL OUT ACTUATOR

FOR SAFETY: Before Leaving Or Servicing Machine; Stop On Level Surface, Set Parking Brake.

1. Raise the rear cover and unplug the battery connector.

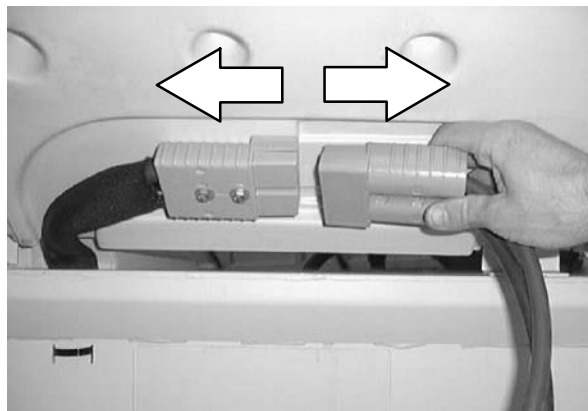

2. Open the top cover and side door.

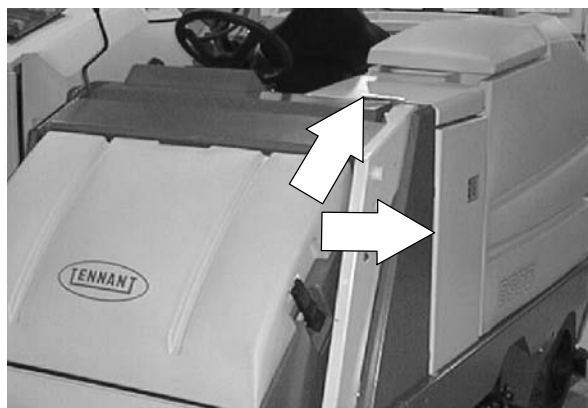

3. Remove the hopper cover, debris filter, and access panel.



ELECTRICAL

4. Locate the hopper roll-out actuator at the left of the sweep vacuum fan housing.

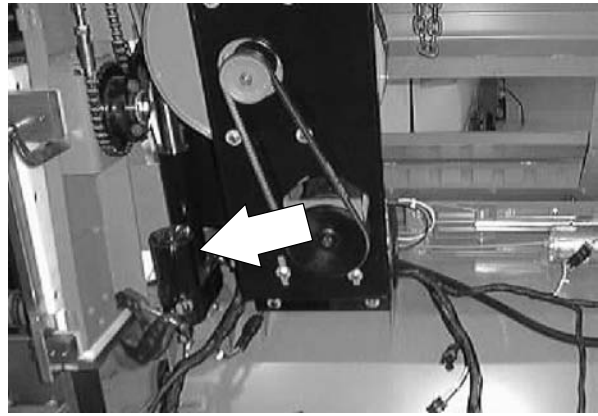

5. Place a block of wood or jack stand under the front of the hopper.



6. Loosen the tension on the primary roll-out chain. *This is done by loosening the chain tensioner assembly.*

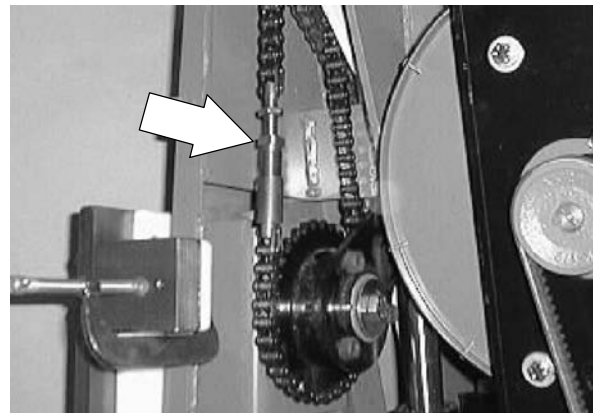

7. Once the tension has been released on the roll-out chain--*the lower cotter pin and clevis pin can be removed.*

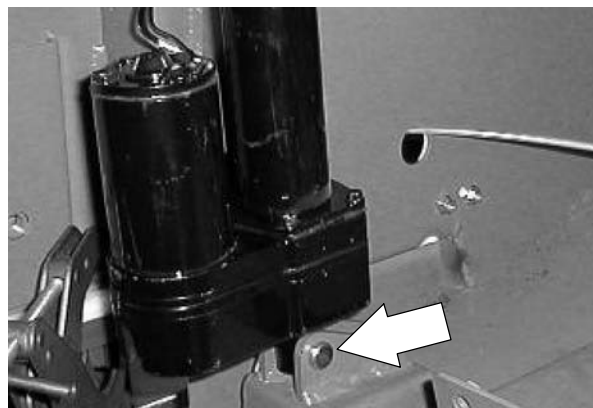

8. Remove the C-clip holding the top of the actuator to the mount pin on the pivot sprocket.

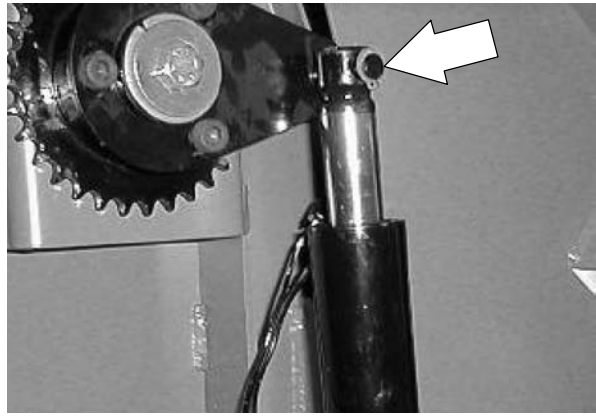

9. Pull the roll-out actuator off the pivot pin.

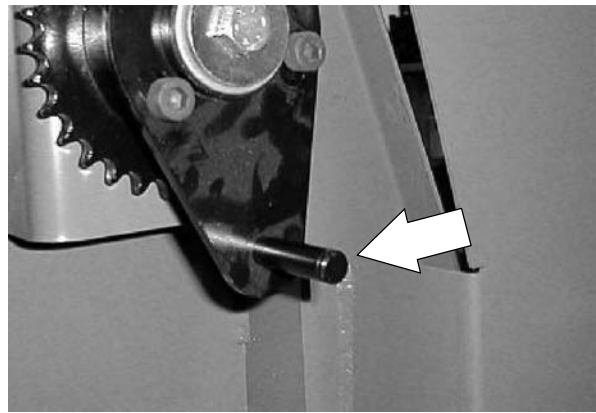

10. Disconnect the actuator from the main harness. Remove the actuator from the machine.

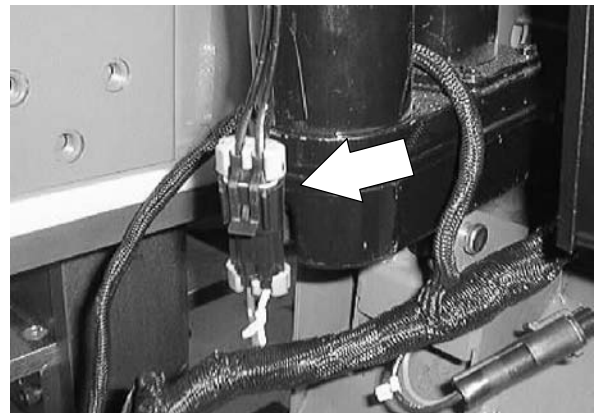

11. Position the new actuator into the machine. *The motor on the actuator faces the rear of the machine.*

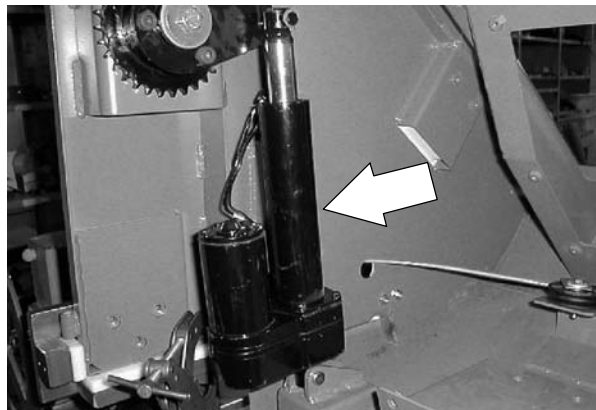

ELECTRICAL

12. Position the top of the actuator rod onto the pin on the pivot hub. Reinstall the C-clip on the rod.

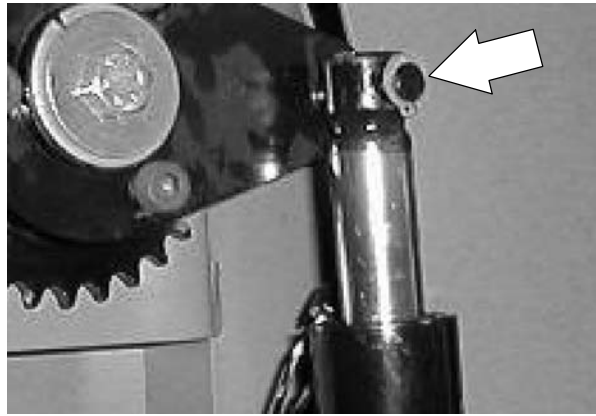

13. Reinstall the clevis pin and cotter pin into the bottom of the actuator at the frame.

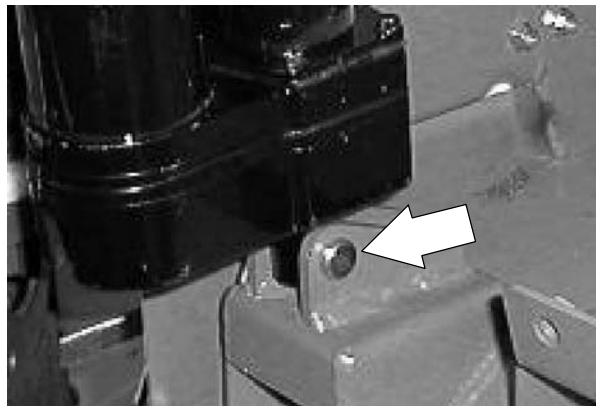

14. Retighten the primary roll-out chain tension adjuster. See TO ADJUST HOPPER PRIMARY ROLL-OUT CHAIN instructions in the SWEEPING section.

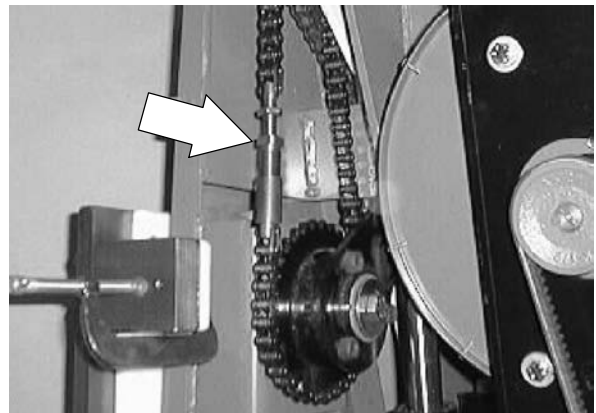

15. Connect the new actuator to the main harness.

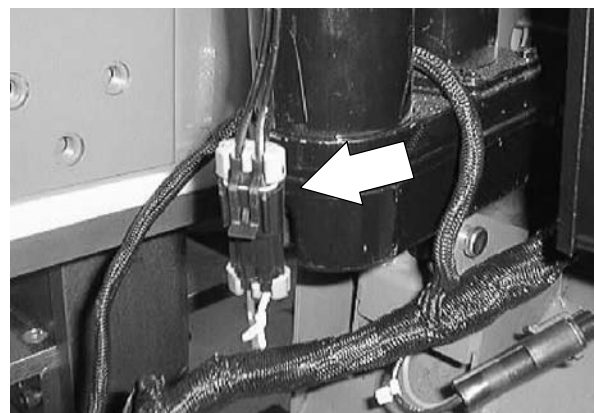

16. Reconnect the battery.

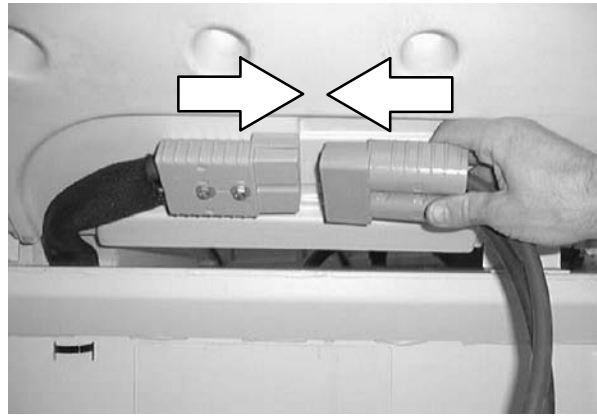

17. Operate the machine. Check the hopper roll-out for proper operation.

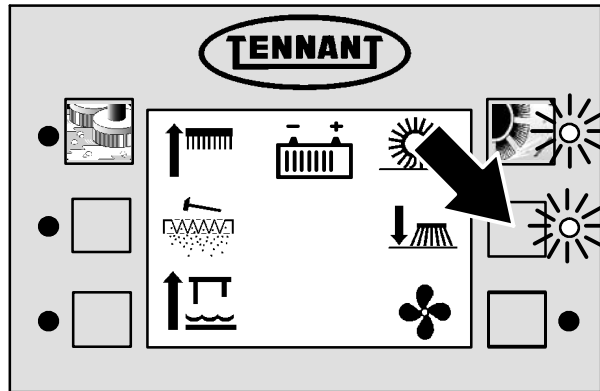

18. Close the top cover and side door.



ELECTRICAL

TO REPLACE SWEEPER MAIN BRUSH LIFT ACTUATOR

FOR SAFETY: Before Leaving Or Servicing Machine; Stop On Level Surface, Set Parking Brake.

1. Start the machine, lower the sweep main brush, turn off the machine.

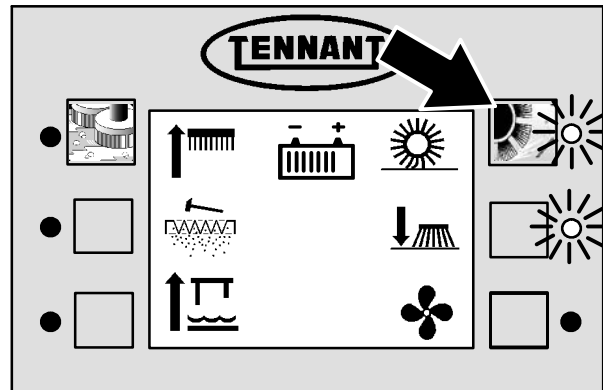

2. Raise the rear cover and unplug the battery connector.

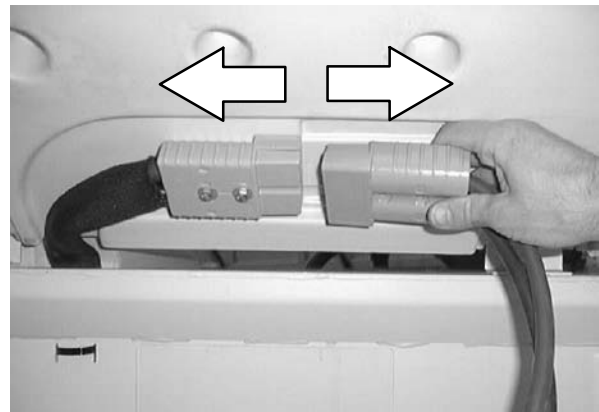

3. Open the top cover and side door.

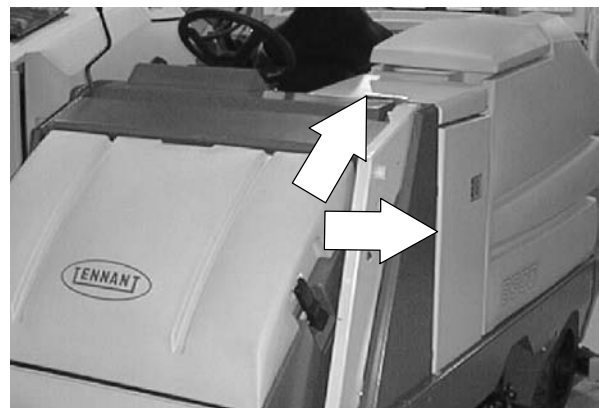

4. Remove the hopper cover, debris filter, and access panel.

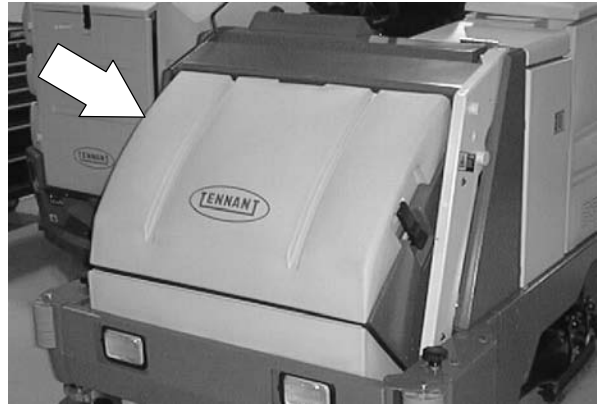

5. Locate the sweep main brush lift actuator on the inside, front area of the sweeper frame.

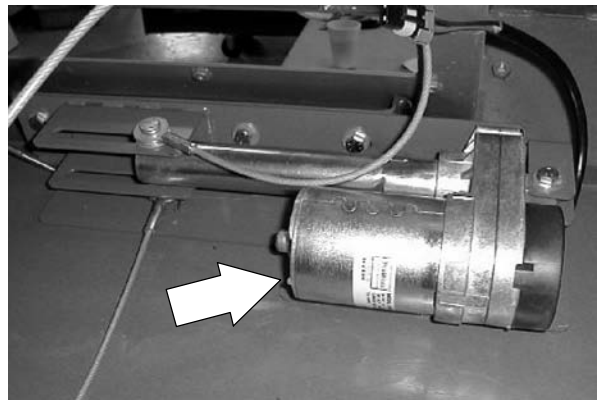

6. Disconnect the actuator from the main harness.

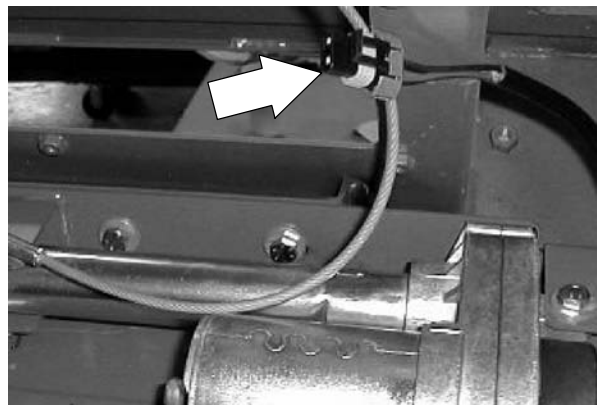

7. Remove the three hex screws holding the actuator mount bracket to the sweeper frame.

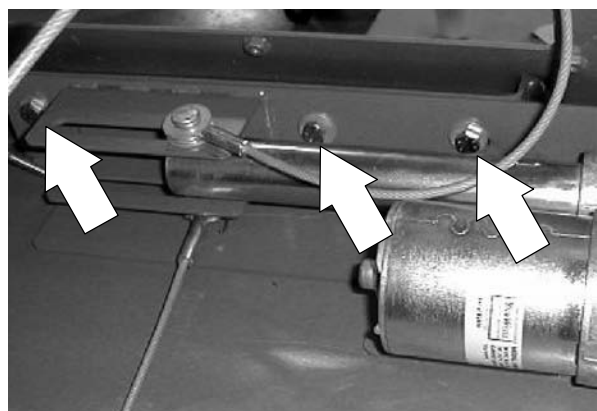

ELECTRICAL

8. Remove the cotter pin from the bottom of the clevis pin at the end of the actuator tube.

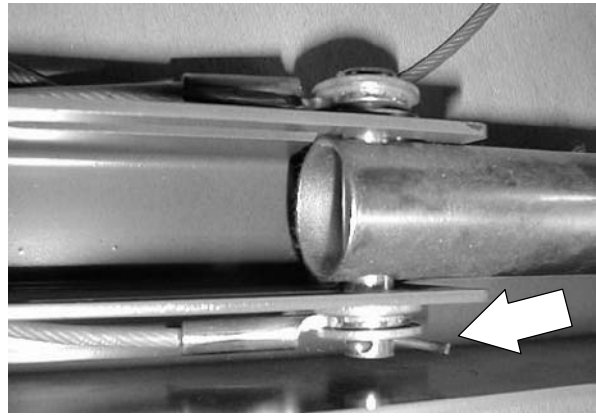

9. Remove the clevis pin and both cables. *Note orientation of cables on the actuator.*

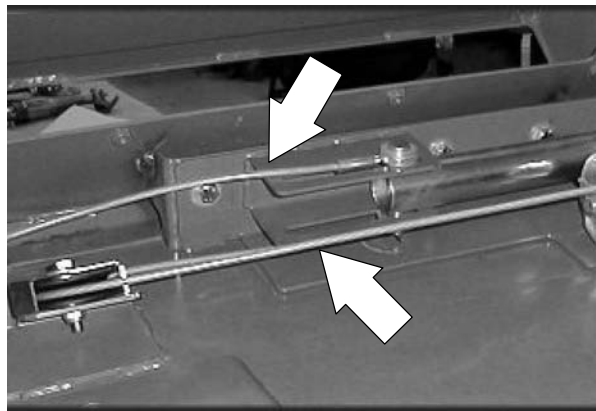

10. Remove the actuator and bracket from the machine.

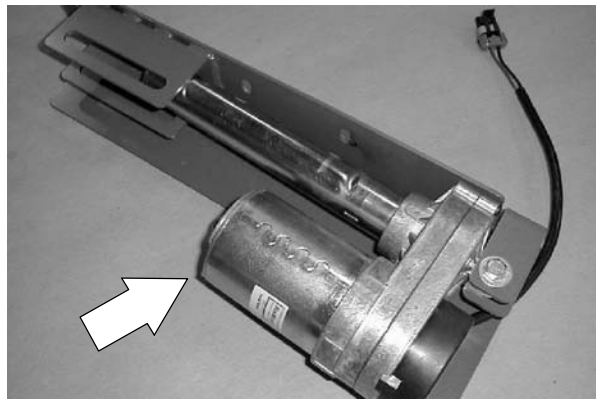

11. Remove the hex screw and nut holding the actuator to the mount bracket. *Remove the actuator from the bracket.*

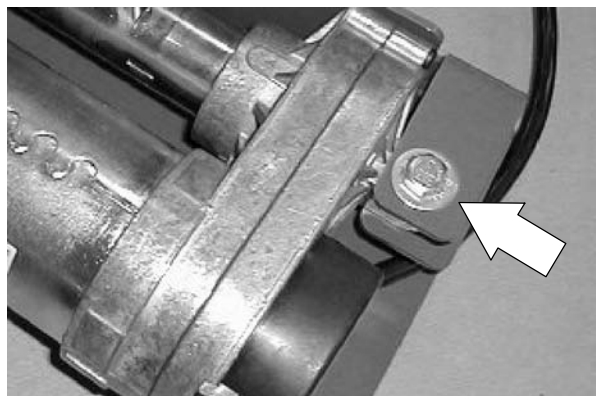

12. Position the new actuator onto the mount bracket. Reinstall the hex screw and nut. Tighten to 18 - 24 Nm (15 - 20 ft lb).

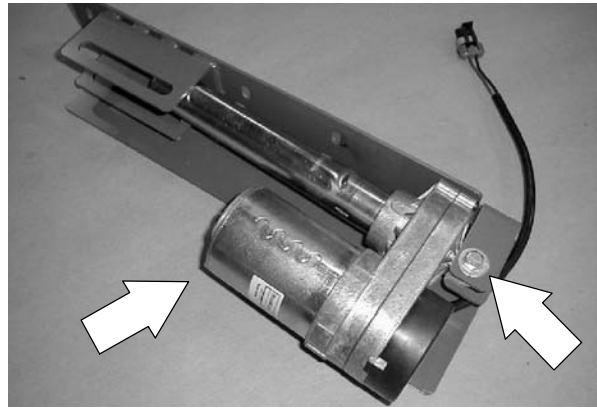

13. Position the actuator and mount bracket into the sweeper frame.

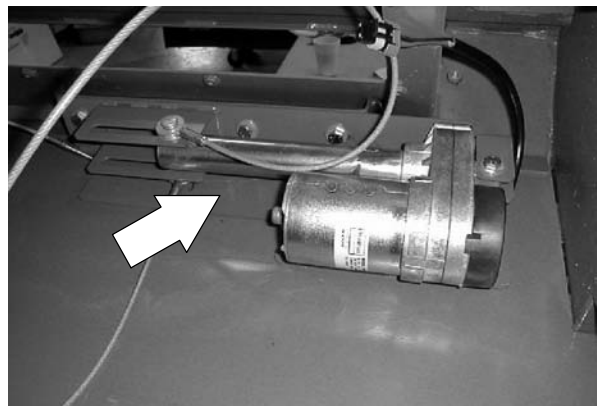

14. Reconnect the ends of the main brush lift cable and the debris flap cable to the tube end of the actuator using the clevis pin and cotter pin.

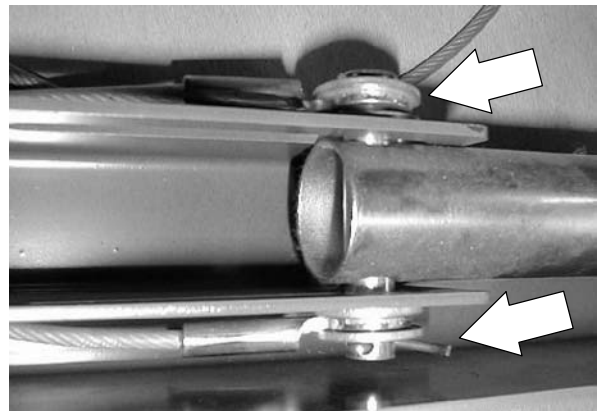

15. Reinstall the three actuator mount screws. Tighten to 18 - 24 Nm (15 - 20 ft lb).

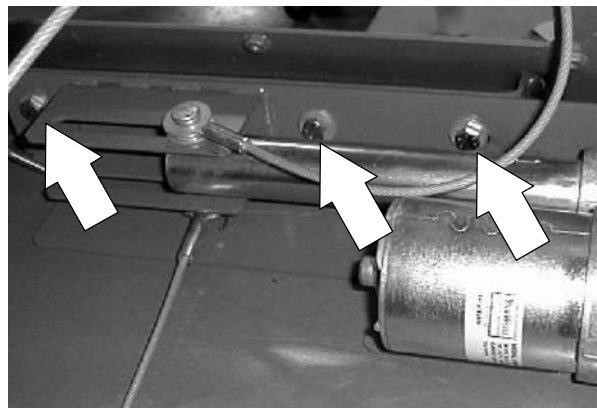

ELECTRICAL

16. Reconnect the main harness to the new actuator.

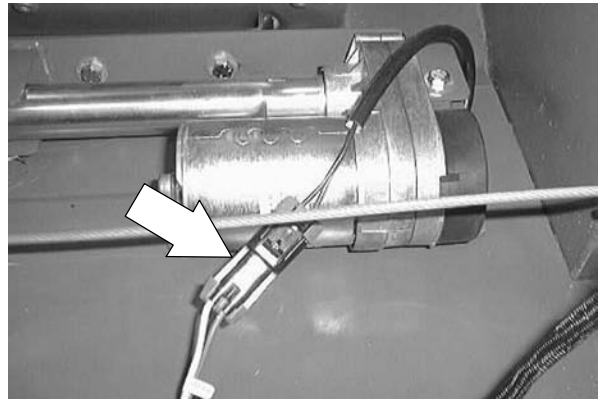

17. Reinstall the access panel, debris filter, and hopper cover.



18. Reconnect the battery.

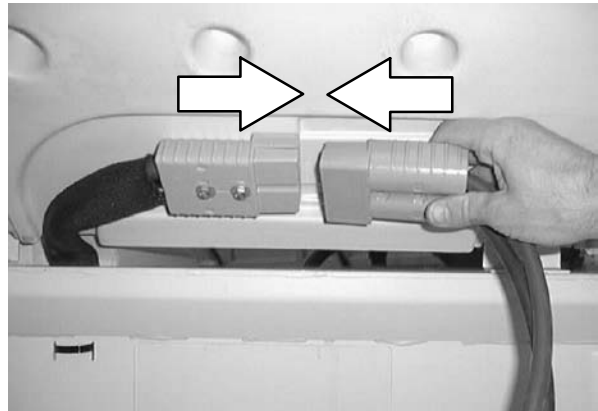

19. Operate the machine. Check the new main brush lift actuator for proper operation.

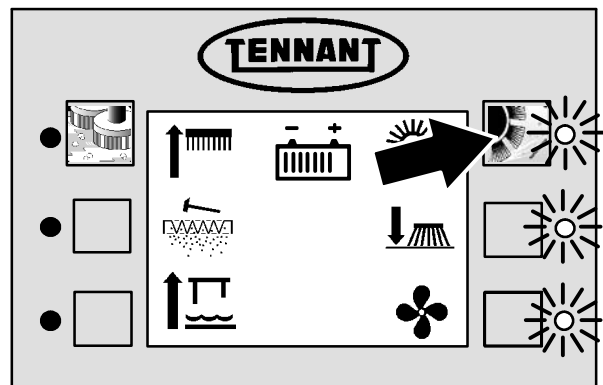

TO REPLACE SIDE BRUSH LIFT ACTUATOR

FOR SAFETY: Before Leaving Or Servicing Machine; Stop On Level Surface, Set Parking Brake.

1. Start the machine, lower the side sweep brush, turn off the machine.

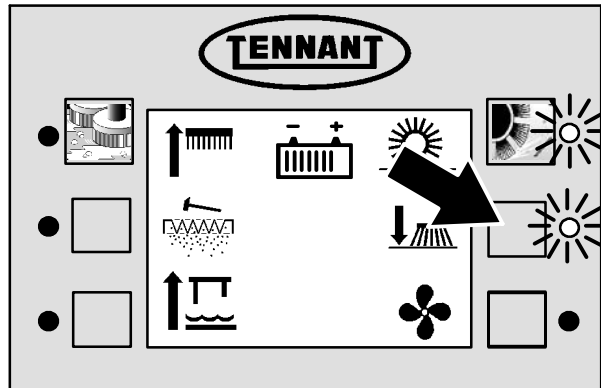

2. Raise the rear cover and unplug the battery connector.

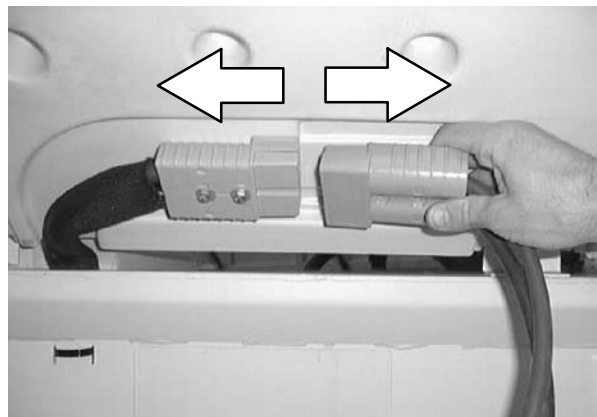

3. Remove the four hex screws holding the side brush assembly to the front bumper.

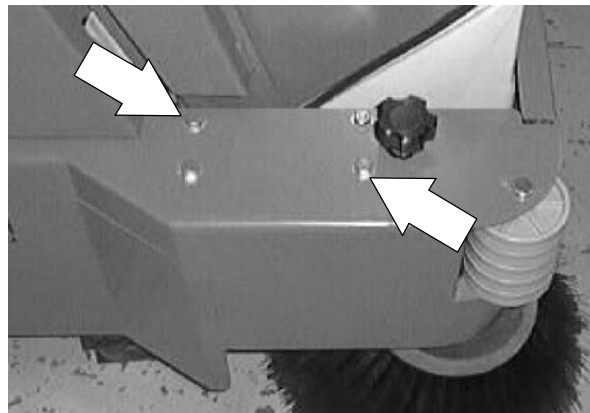

ELECTRICAL

- Drop the side brush assembly housing down and out of the front bumper. Disconnect the actuator connector and side brush motor connector.

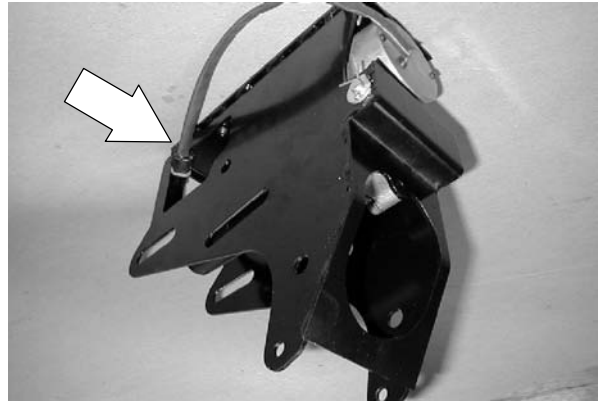

- Remove the five cotter pins and five clevis pins holding the actuator and pivot brackets to the side brush assembly housing.

NOTE: Make sure to take note on how the side brush lift assembly come apart when removing the five clevis pins.

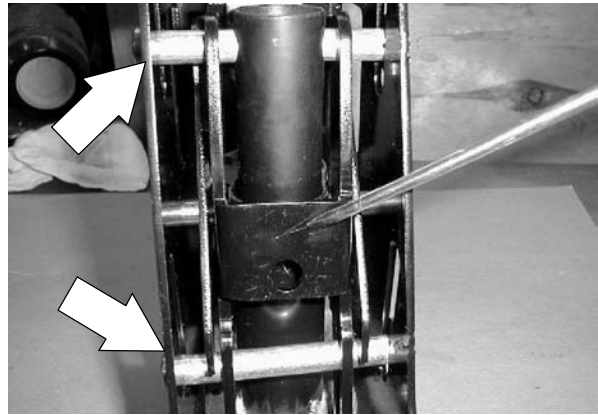

- Pull the side brush lift actuator out of the housing.

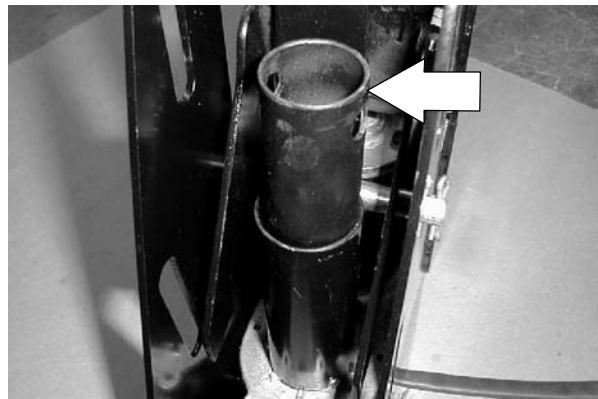

- Position the new actuator into the side housing with the motor end facing the back of the mount housing. Reinstall the smaller diameter clevis pin and cotter pin into the housing and actuator.

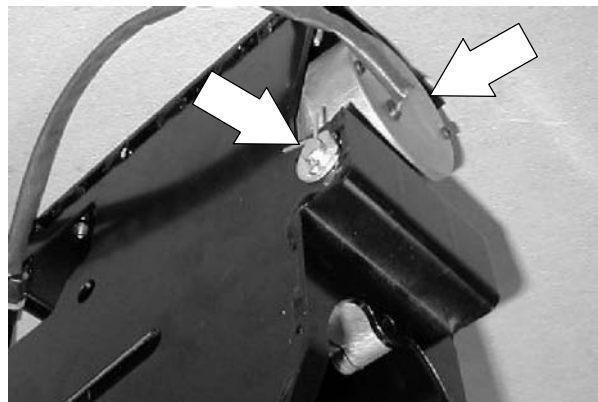

8. Finish assembling the rest of the side brush lift brackets and clevis pins.

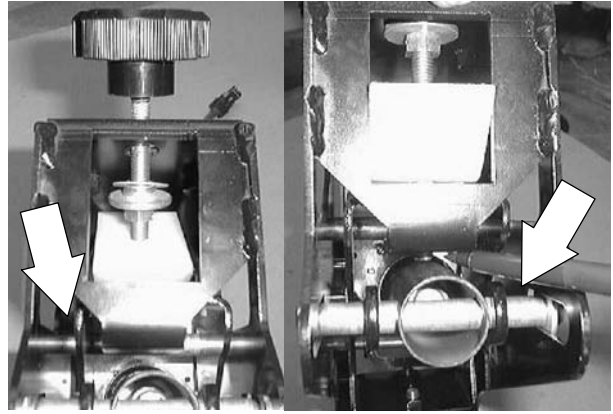

9. Position the side brush assembly into the front bumper. Make sure to reconnect the main harness to the new actuator and side brush motor.

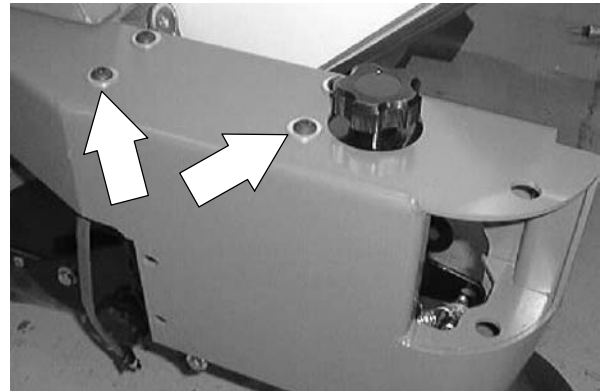

10. Reconnect the battery.

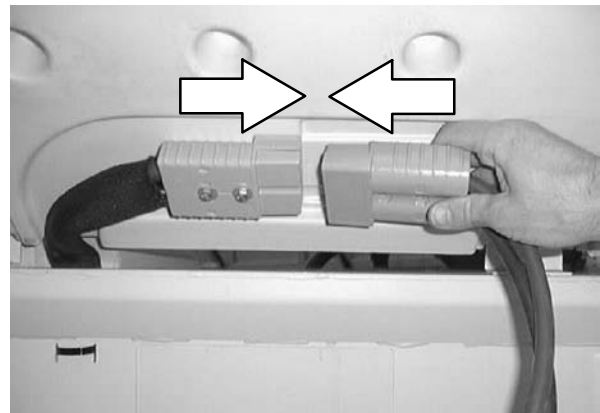

11. Operate the machine. Check the side brush lift actuator for proper operation.

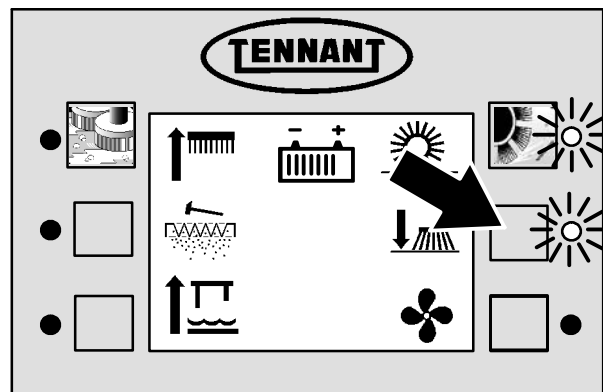

ELECTRICAL SCHEMATIC

NOTE: WITH CYLINDRICAL BRUSH MOTORS:
CONNECT ADAPTOR HARNESS 363468 TO THE
LEFT BRUSH MOTOR FOR CORRECT BRUSH
DIRECTION ROTATION.

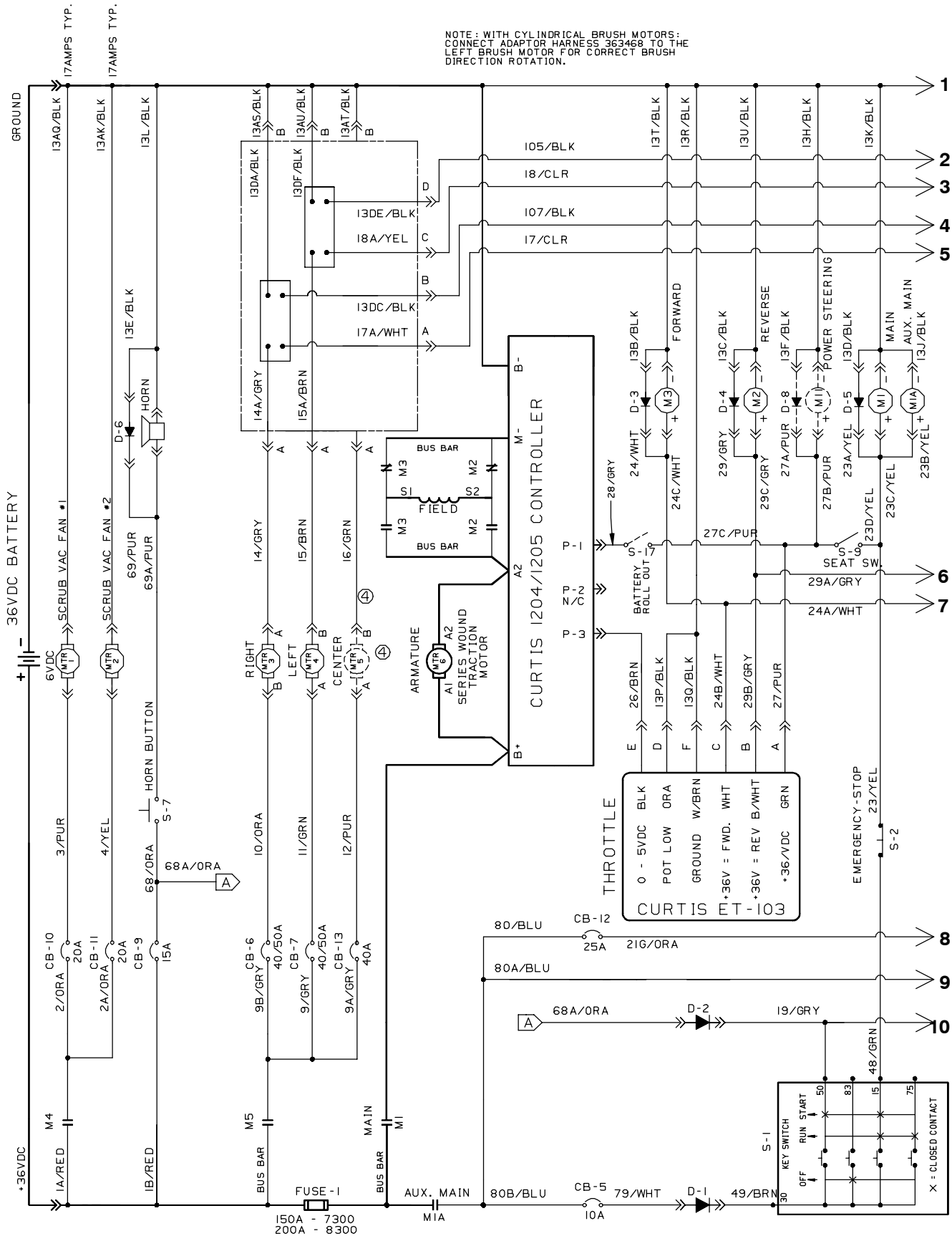

353346

ELECTRICAL SCHEMATIC

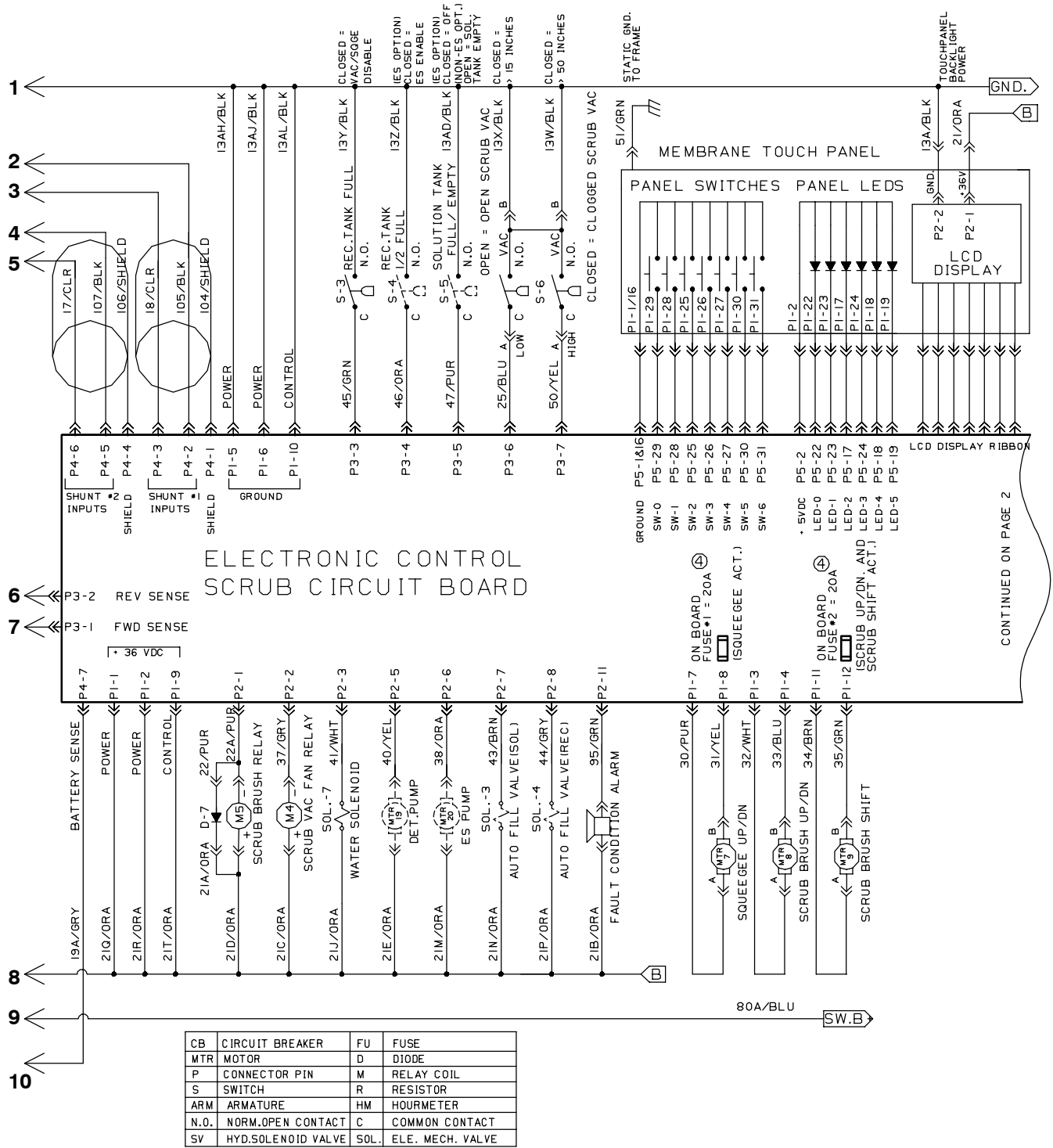

353346

ELECTRICAL SCHEMATIC

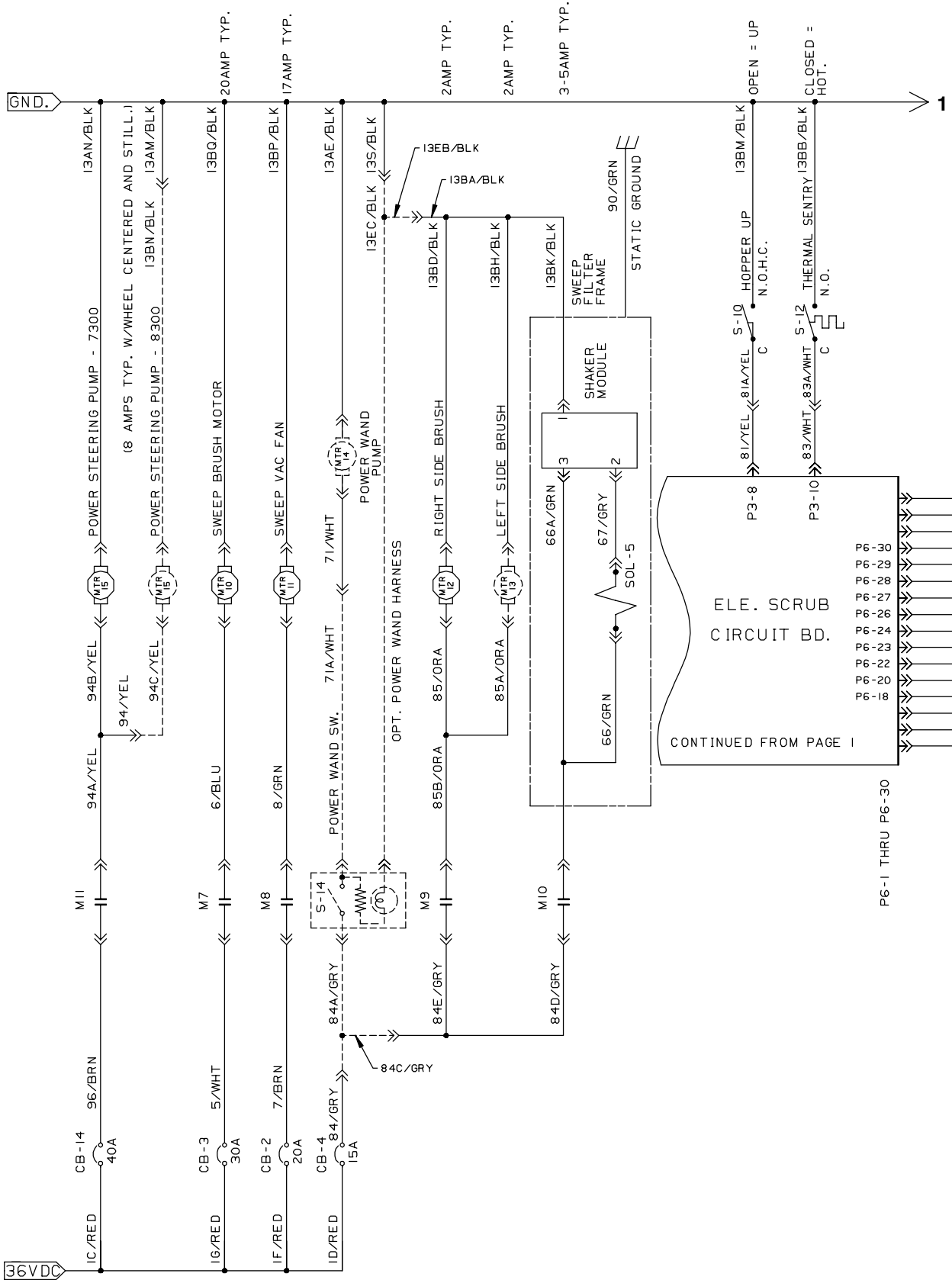

8300 ONLY OPT.

ELECTRICAL SCHEMATIC

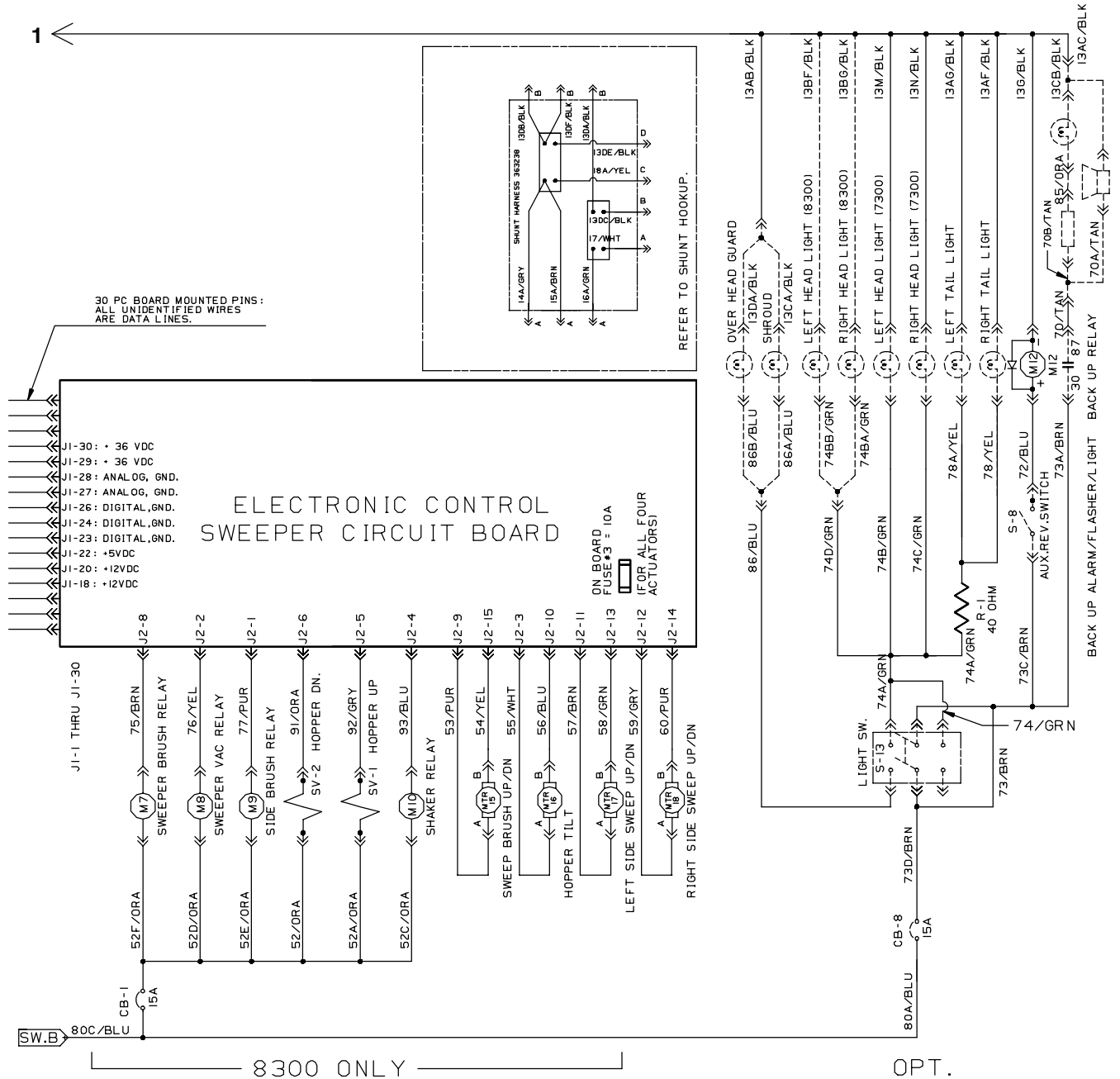

ELECTRONIC CONTROL SWEEPER CIRCUIT BOARD

30 PC BOARD MOUNTED PINS:
ALL UNIDENTIFIED WIRES
ARE DATA LINES.

J1-30: + 36 VDC
J1-29: + 36 VDC
J1-28: ANAL OG, GND.
J1-27: ANAL OG, GND.
J1-26: DIGITAL, GND.
J1-24: DIGITAL, GND.
J1-23: DIGITAL, GND.
J1-22: +5VDC
J1-20: +12VDC
J1-18: +12VDC

J1-1 THRU J1-30

8300 ONLY

OPT.

LEGEND

CB	CIRCUIT BREAKER	FU	FUSE
MTR	MOTOR	D	DIODE
P	CONNECTOR PIN	M	RELAY COIL
S	SWITCH	R	RESISTOR
ARM	ARMATURE	HM	HOURLMETER
N.O.	NORM. OPEN CONTACT	C	COMMON CONTACT

WIRE HARNESS GROUP

Main Wire Harness

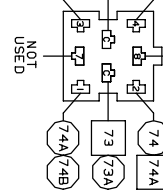
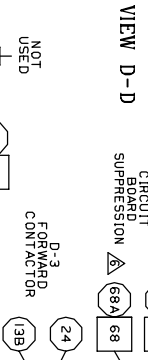
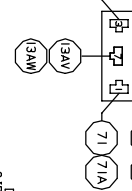
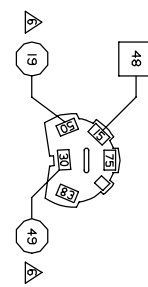
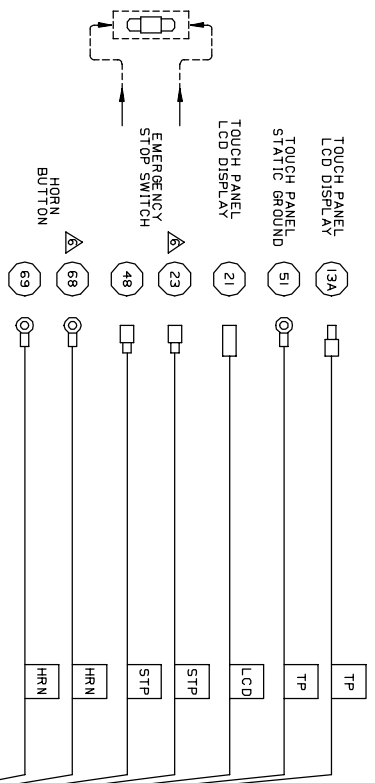

CONNECTOR - VIEWED FROM THE BACK, IS NOT ALPHABETICALLY MARKED AS SHOWN IN DETAIL

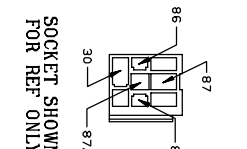
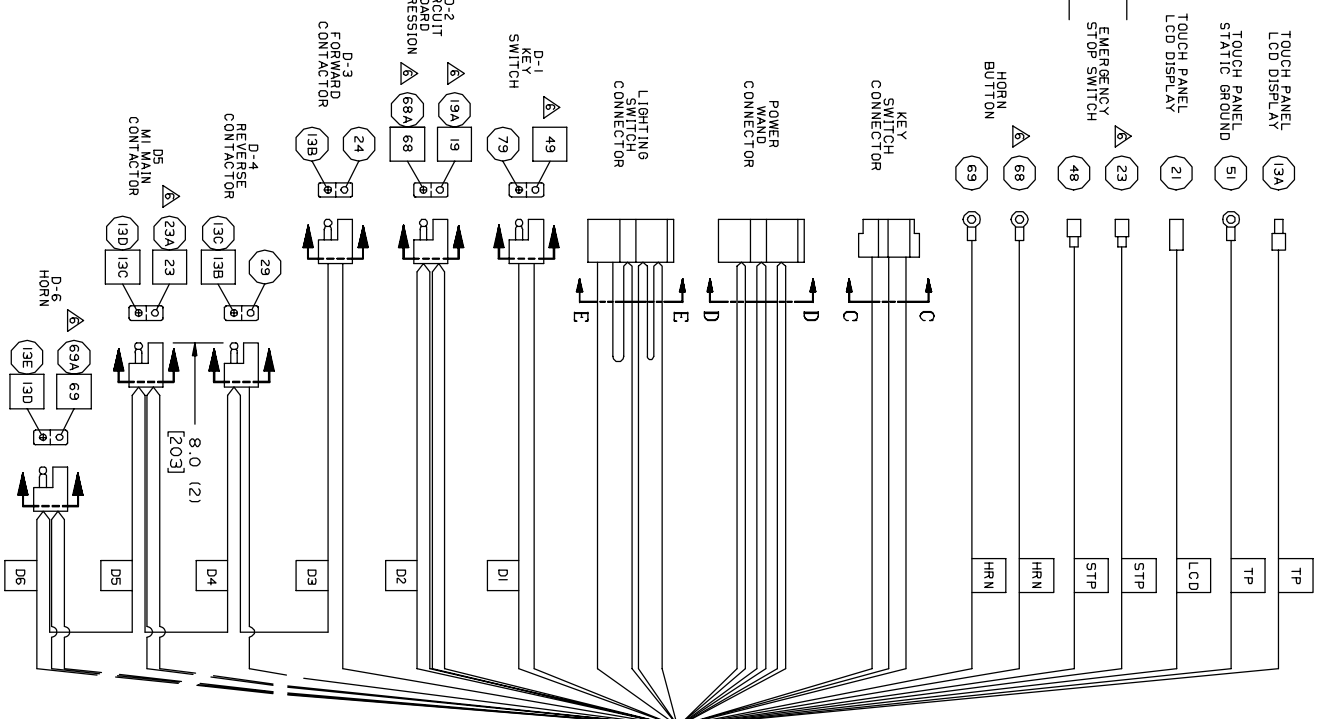

DETAIL G

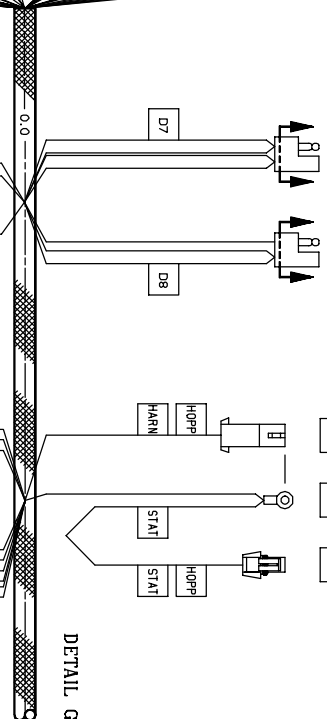

WIRE HARNESSES GROUP

Main Wire Harness

SOCKET NO.	WIRE NO.	SHD
2	105	SHD
3	106	SHD
4	107	SHD
5	108	SHD
6	109	SHD
7	110	SHD
8	111	SHD
9	112	SHD

DETAIL K-K

SOCKET NO.	WIRE NO.	SHD
2	37	SHD
3	41	N/A
4	40	N/A
5	43	N/A
6	44	N/A
7	49	N/A
8	43	N/A
9	44	N/A
10	49	N/A
11	95	N/A
12	N/A	N/A

DETAIL L-L

SOCKET NO.	WIRE NO.	SHD
2	210	SHD
3	32	SHD
4	33A	SHD
5	134M	SHD
6	30	SHD
7	31	SHD
8	215	SHD
9	134L	SHD
10	35	SHD
11	39	SHD
12	N/A	N/A

DETAIL M-M

SOCKET NO.	WIRE NO.	SHD
2	29A	SHD
3	45	SHD
4	45	SHD
5	45	SHD
6	25	SHD
7	80	SHD
8	81	SHD
9	82	SHD
10	83	SHD
11	N/A	N/A
12	N/A	N/A
13	N/A	N/A
14	N/A	N/A
15	N/A	N/A

DETAIL N-N

DETAIL K-K
NOTE: CIRCUITS 17/52LR,
18/52LR, 106/52LR, 44/52LR,
104/52LR, 106/52LR TO HAVE
LID LABELS AT BOTH ENDS.
ON SHEET 9 OF 12

(104) SHIELDED
CABLE (REF)
(106) SHIELDED
CABLE (REF)
**4, (6) FOR LABEL
INFORMATION
SEE DETAIL K-K
NOT SHIELDED
CABLE (2) - SEE
SHEET 9 OF 12

CIRCUIT BOARD

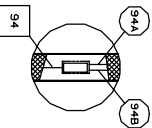

DETAIL T

DETAIL U

DETAIL V

DETAIL Z

DETAIL AA

DETAILS P, Q, R, S

DETAILS H, J

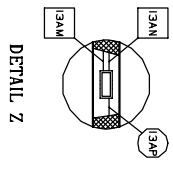
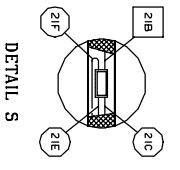
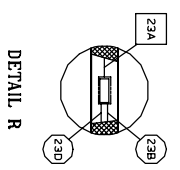
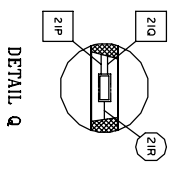
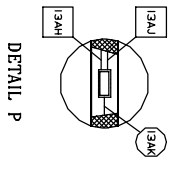
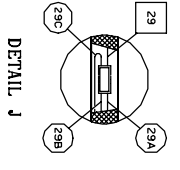
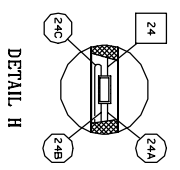
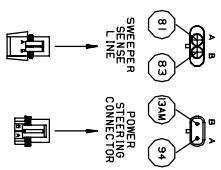
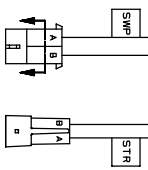

WIRE HARNESSES GROUP

Main Wire Harness

DETAIL V
CONTINUED
ON SHEET
4 OF 12

R-1
40 OHM
RESISTOR
74C

R-1
40 OHM
RESISTOR
78

DETAIL U
ROTATED 90°
CONTINUED FROM
SHEET 2 OF 12

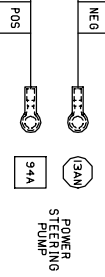

DETERGENT PUMP



L.H.
HEADLIGHTS
13N 74C
13M

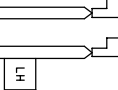

DETAIL Y-Y

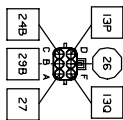

ACCELERATOR

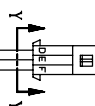

R.H.
HEADLIGHTS
13N
74C



DETAIL X

DETAIL X

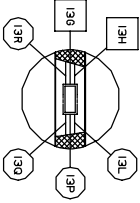

HORN
13L
S3A
13M

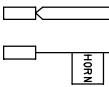

WIRE HARNESSES GROUP

DETAIL W
CONTINUED ON
SHEET 4 OF 12

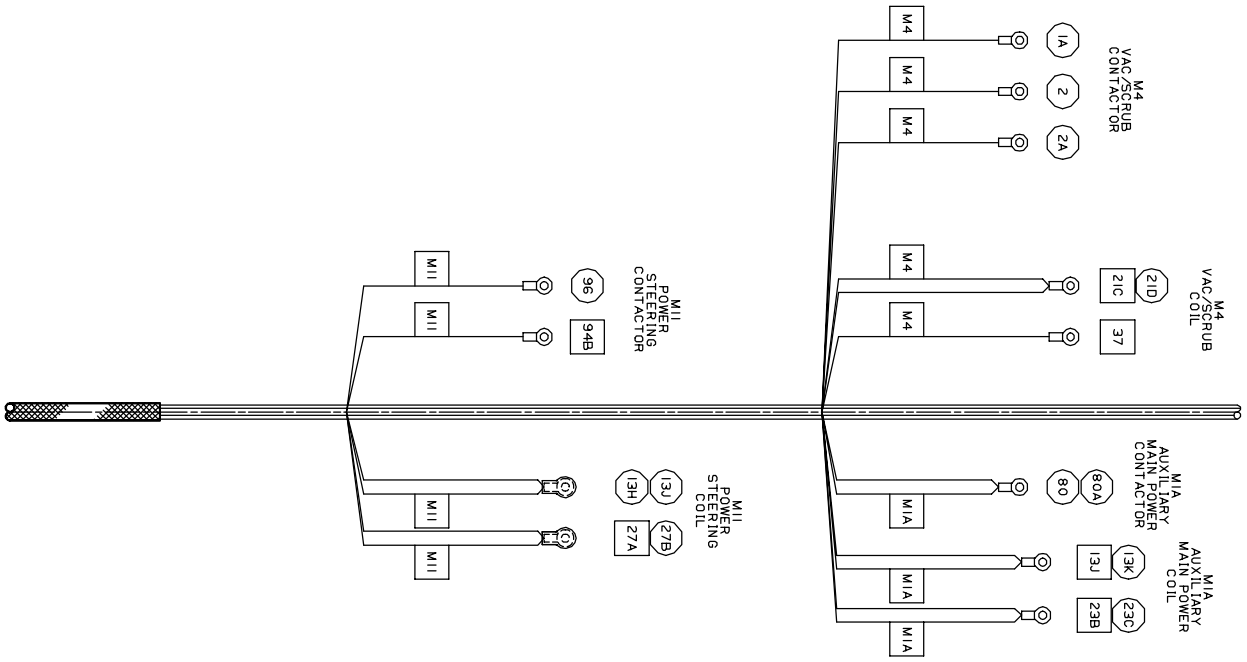

Main Wire Harness

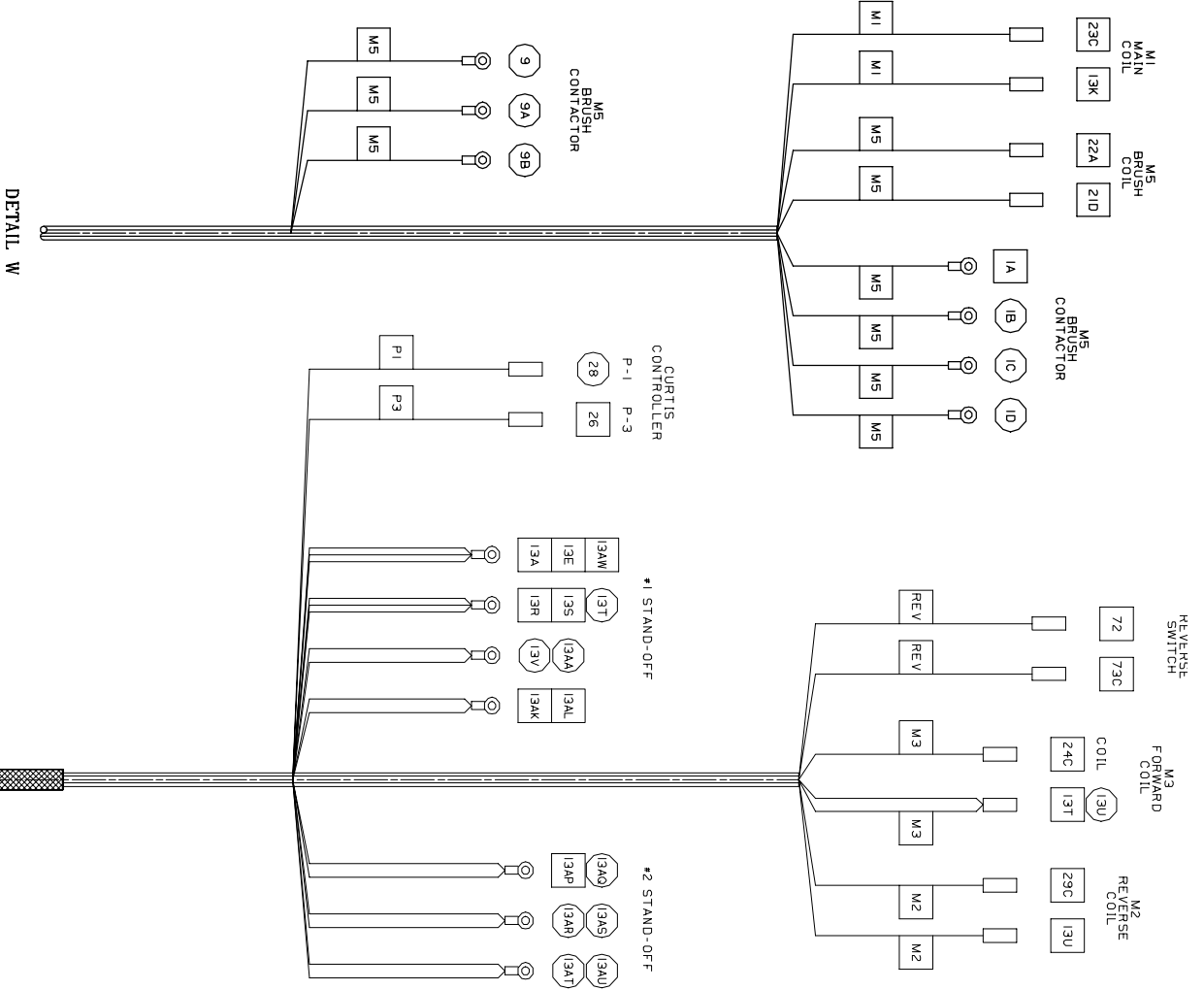

DETAIL AE
ROTATED 90°

WIRE HARNESSES GROUP

Main Wire Harness

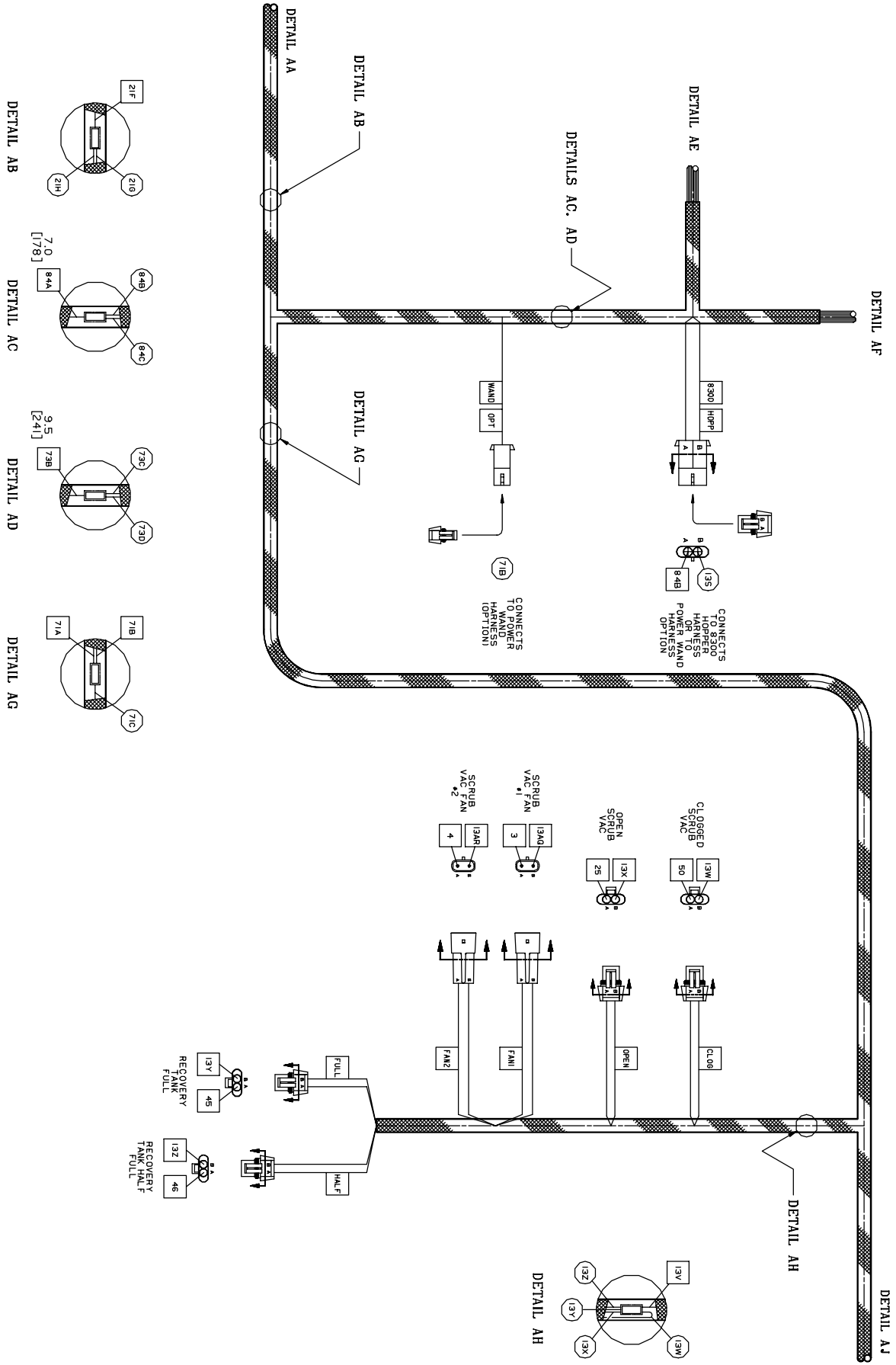

Main Wire Harness

WIRE HARNESS GROUP

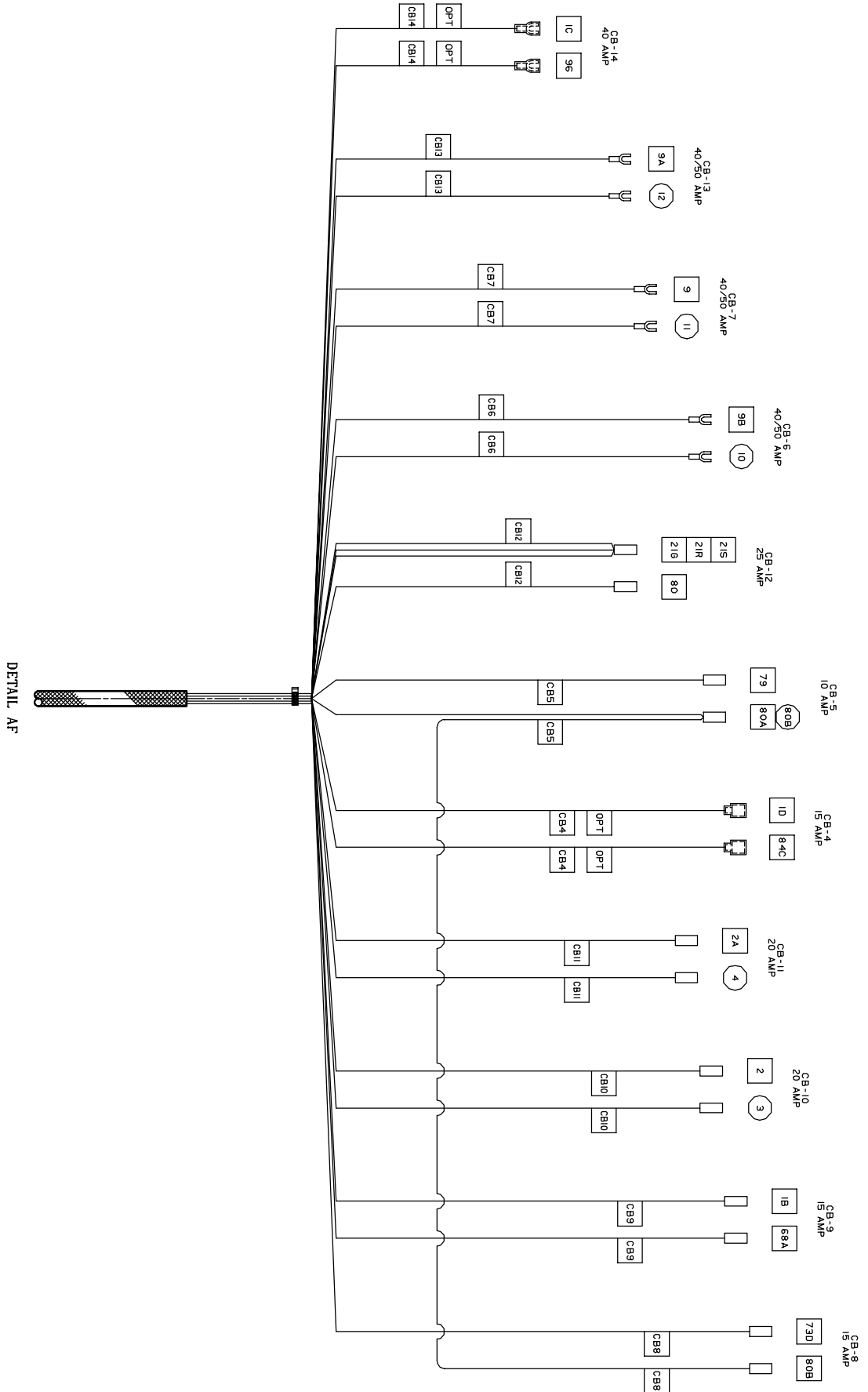

WIRE HARNESSES GROUP

Main Wire Harness

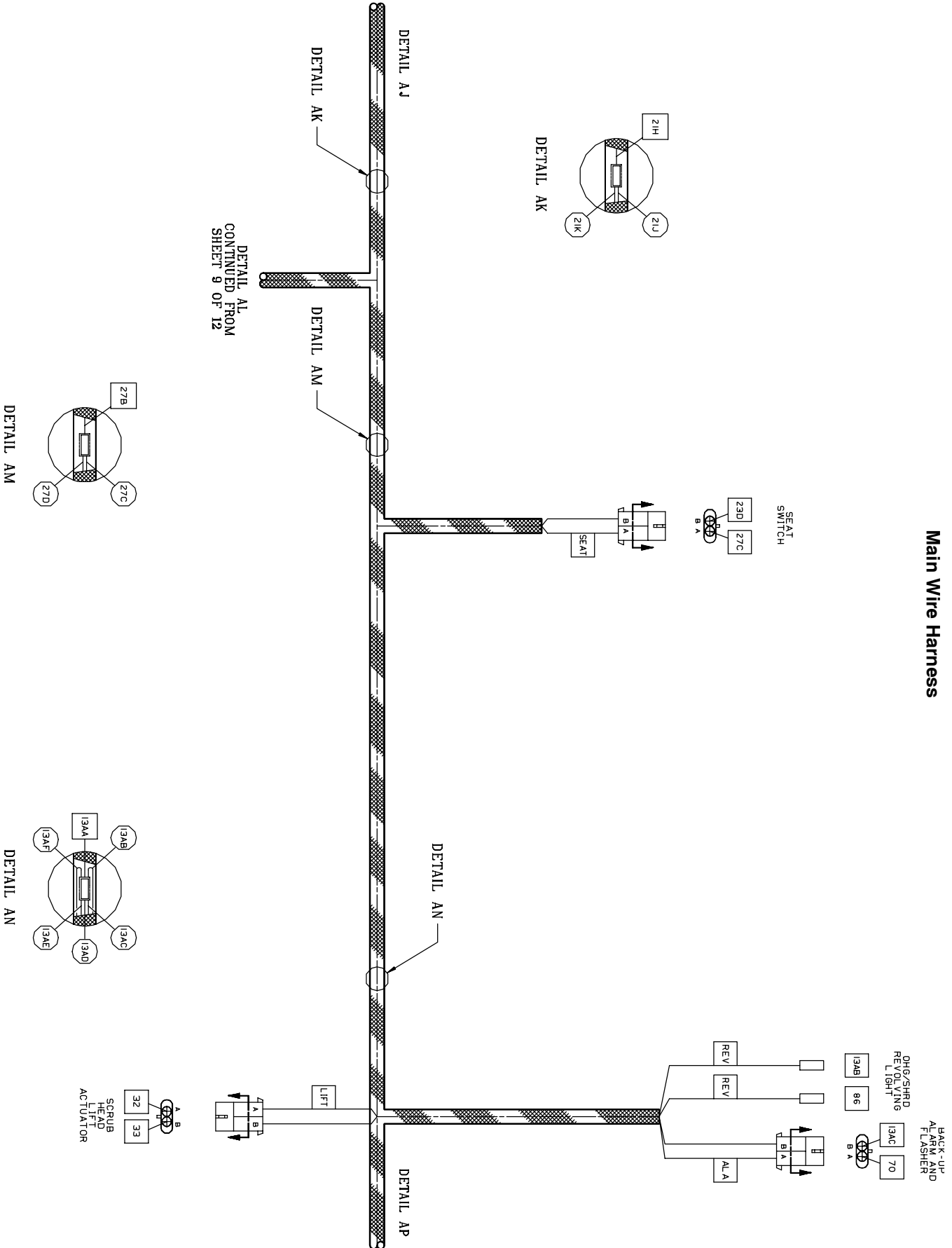

WIRE HARNESSES GROUP

Main Wire Harness

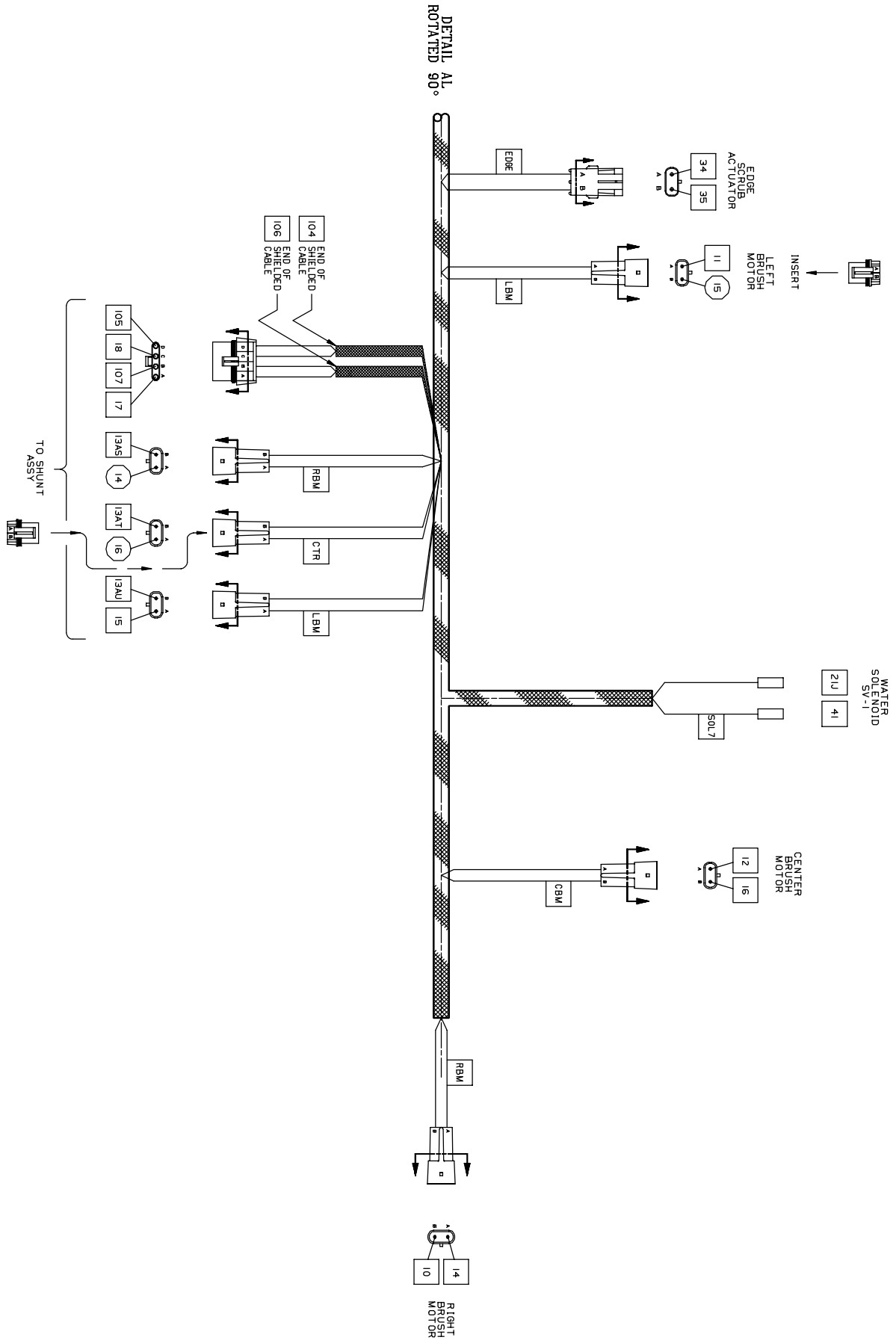

WIRE HARNESSES GROUP

Main Wire Harness

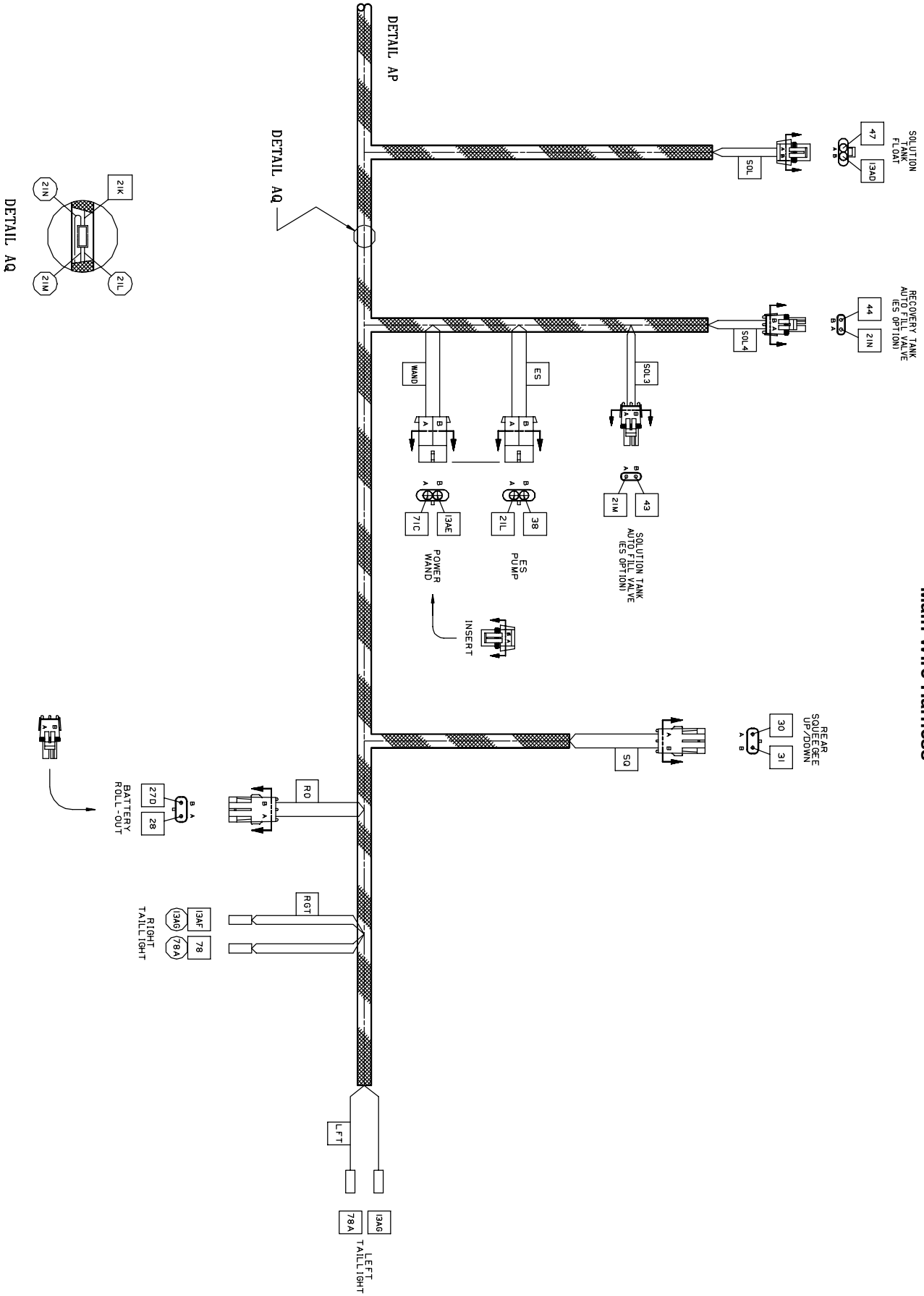

WIRE HARNESSES GROUP

Hopper Harness Group

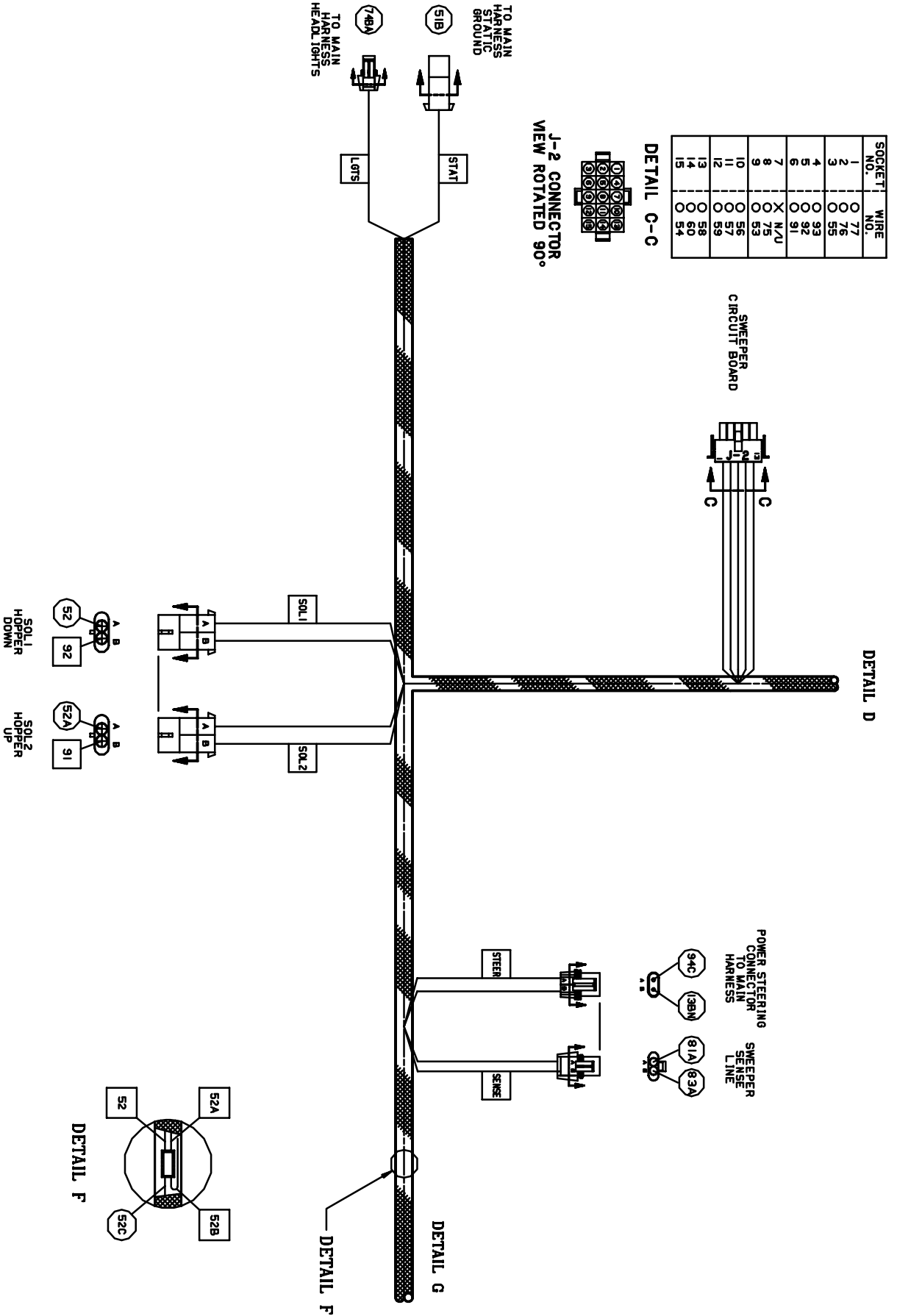

WIRE HARNESSES GROUP

Hopper Harness Group

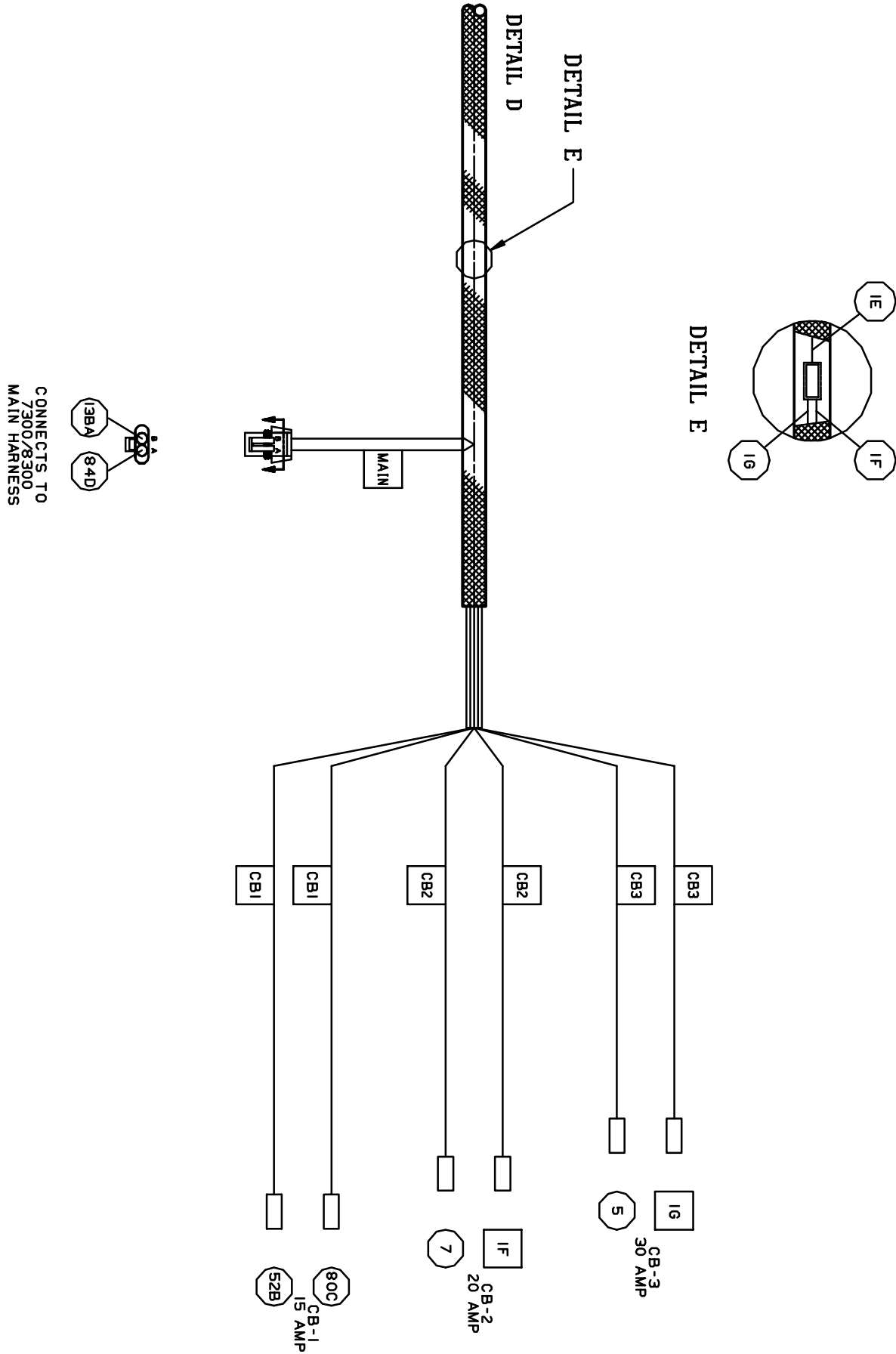

WIRE HARNESSES GROUP

Hopper Harness Group

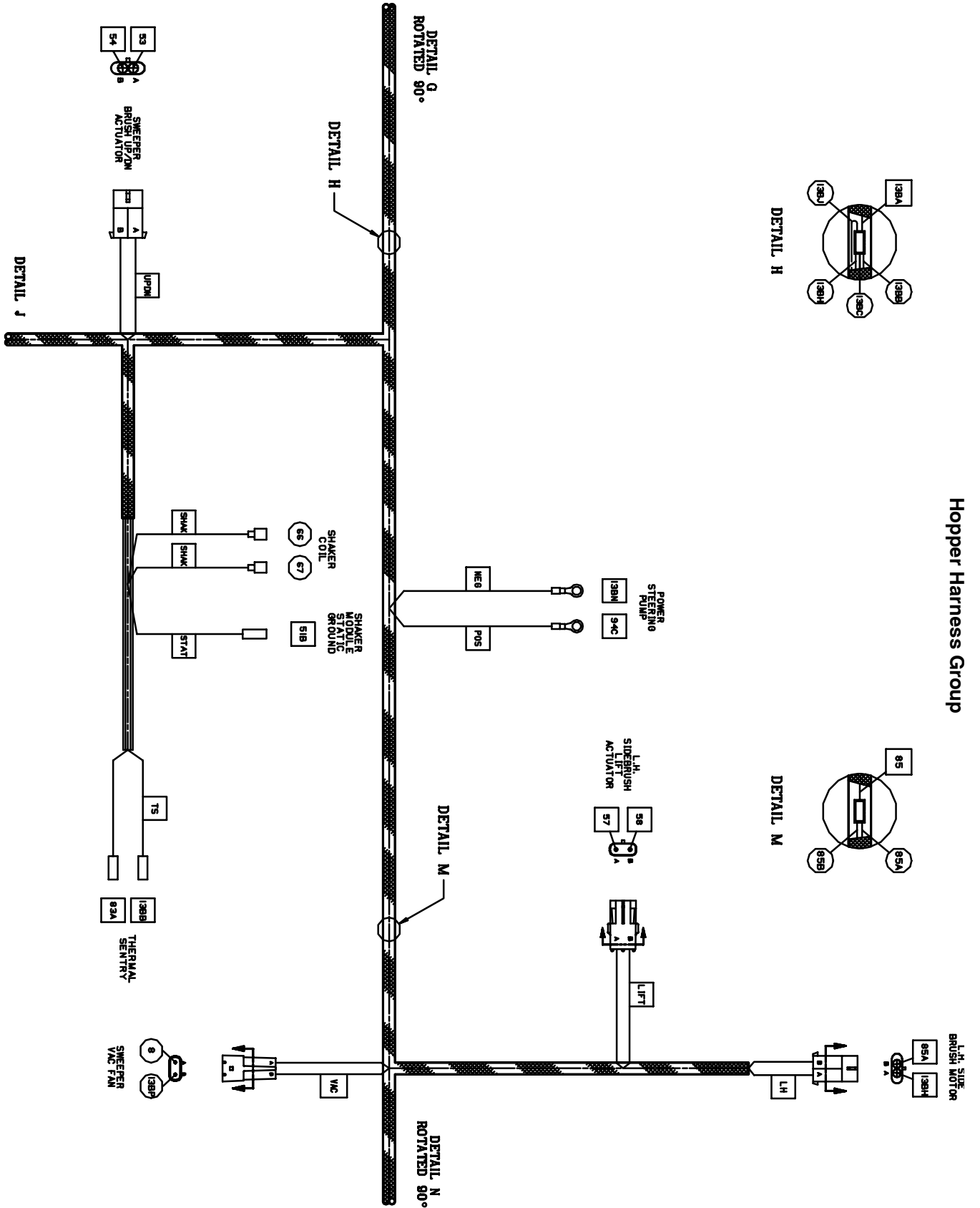

WIRE HARNESSES GROUP

Hopper Harness Group

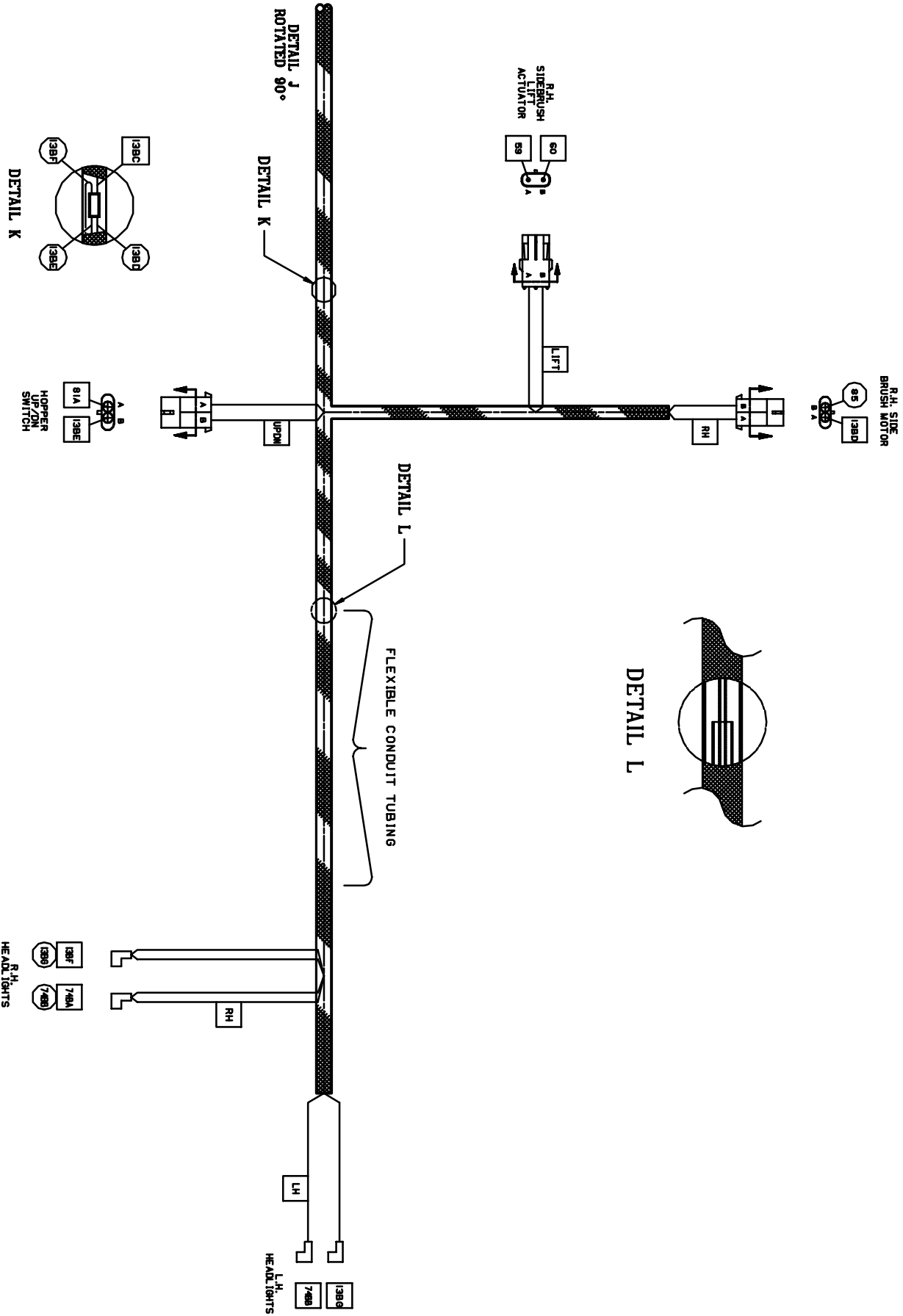

WIRE HARNESSES GROUP

Hopper Harness Group

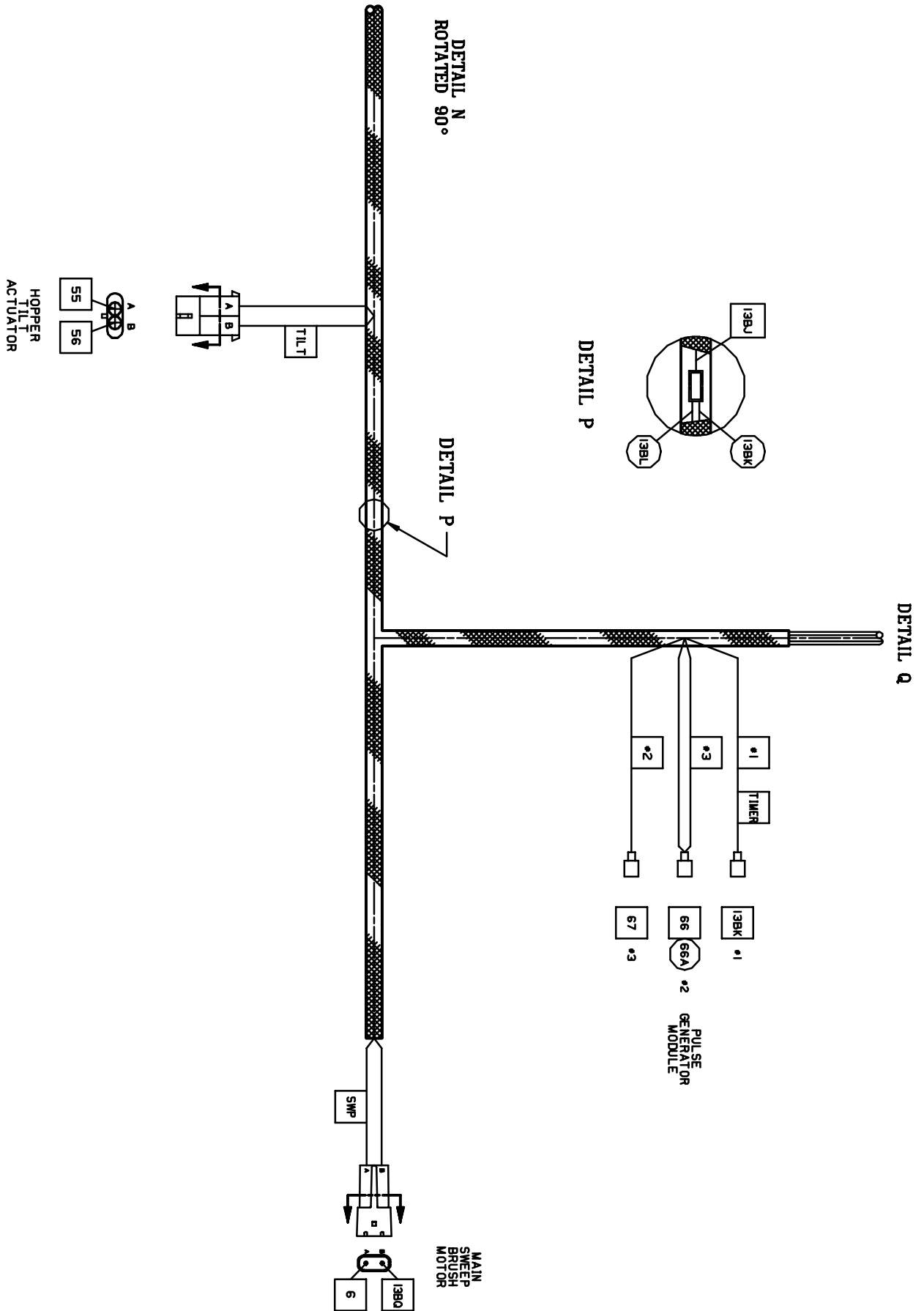

WIRE HARNESSES GROUP

Hopper Harness Group

DETAIL R

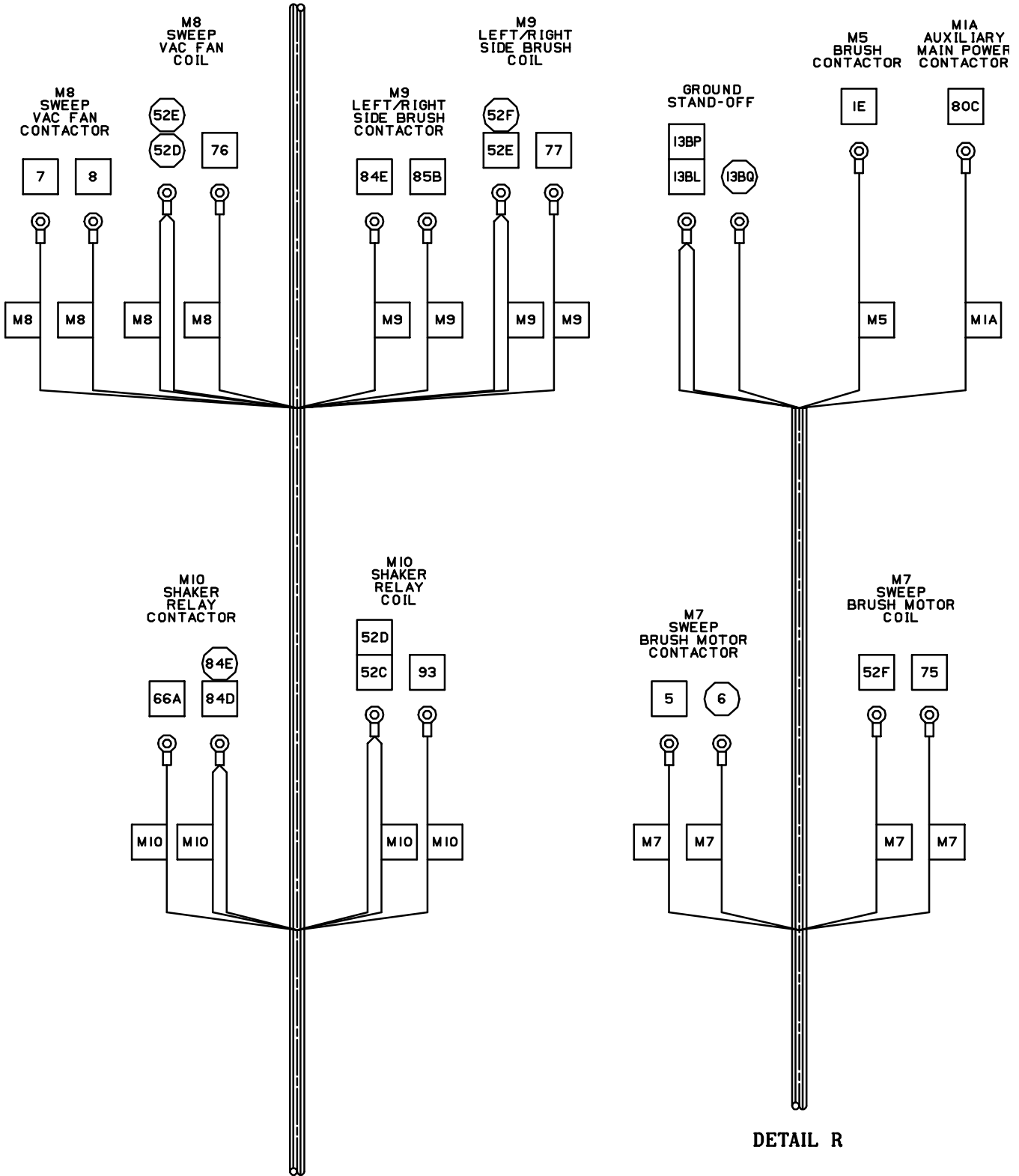

DETAIL R

DETAIL Q

DIAGNOSTICS-8300

The Model 8300 has an on-board diagnostic system.

The first part of the diagnostics section describes the different operating modes that can be activated by using an entry sequence on the dash panel. There is also a chart describing the normal mode messages that may appear on the dash panel.

OPERATING MODES

The sweep and scrub functions of the 8300 are controlled using a touch panel with two dedicated buttons, and 6 multi-function buttons. The multi-function buttons surround a graphics display panel. Images on the display panel identify the current function of the six buttons.

The intent of the system is to offer one button sweeping and scrubbing, while reducing the number of controls confronting the operator. This is accomplished by using multi-function buttons. This system is designed to offer the operator control of the functions which are appropriate for the current task. An example would be the operation of the hopper door. If the operator is sweeping, the hopper door will automatically open. It would be inappropriate for the operator to close the door while sweeping, so none of the multi-function switches are assigned to the hopper door. If the operator lifts the hopper (presumably to dump), the operator needs to have control of the hopper door. The door icon will appear on the screen, and one of the six multi-function switches will be assigned the function of opening or closing the door.

The 8300 has 5 operating, and 7 maintenance modes. The operating modes are engaged using the 6 multi-function buttons. The button which is inside the Tennant logo (logo button) will scroll the machine through the various operating modes without engaging any functions. The maintenance modes are enabled by pressing the logo button, turning on the machine, waiting 15 seconds, and releasing the logo button. Maintenance modes can then be chosen using the multi-function buttons.

8300 OPERATING MODES

OPERATING MODE	ENTRY SEQUENCE	FUNCTIONS AVAILABLE	DESCRIPTION
● IDLE MODE	1. This is the mode in which the panel will normally power up.	1. Scrub 2. No function 3. Squeegee 4. Sweep 5. Hopper up 6. Hopper down	This mode gives the operator the basic, sweep, scrub, and water pickup modes.
● SCRUB MODE	1. Pressing the scrub button from the idle mode. 2. Pressing the logo button from the idle mode.	1. Scrub 2. Edge scrub 3. Squeegee 4. Sweep 5. Detergent metering 6. ES function	This mode gives the operator control of all scrub functions.
● SWEEP MODE	1. Pressing the sweep button from the idle mode. 2. Pressing the logo button from the scrub mode.	1. Scrub 2. Filter shaker 3. Squeegee 4. Sweep 5. Side brush 6. Sweep fan	This mode gives the operator control of all sweep functions.
● HOPPER UP MODE <i>-These are unavailable until minimum hopper height is obtained.</i>	1. Lifting the hopper (releasing the hopper down switch). 2. Pressing the logo button from the sweep mode.	1. Scrub 2. Filter shaker 3. Hopper tilt up 4. Hopper tilt down 5. Hopper up 6. Hopper down	This mode gives the operator control of the hopper door.
● SWEEP/SCRUB MODE	1. Pressing the scrub button while in the sweep mode. 2. Pressing the sweep button while in the scrub mode.	1. Edge scrub 2. Squeegee 3. Sweep 4. Side brush 5. Sweep fan	This mode gives the operator control of the primary sweep controls, and the three primary scrub controls.

ELECTRICAL

8300 MAINTENANCE MODES

MAINTENANCE MODE	ENTRY SEQUENCE	FUNCTIONS AVAILABLE	DESCRIPTION
● MAINTENANCE 1 MODE	<ol style="list-style-type: none"> 1. Hold logo key 2. Turn machine on 3. Hold logo key for 15 seconds 4. Release logo key 	<ol style="list-style-type: none"> 1. Enable left side brush 2. Display current 3. Manual mode 4. No function 5. No function 6. No function 	This mode allows the operator to choose from the first three maintenance modes.
● MAINTENANCE 2 MODE	<ol style="list-style-type: none"> 1. Hold logo key 2. Turn machine on 3. Hold logo key for 15 seconds 4. Release logo key 5. Press and release logo key 2 times. 	<ol style="list-style-type: none"> 1. Input display mode 2. Enable Edge Scrub mode 3. Time adjust mode 4. No function 5. No function 6. No function 	This mode allows the operator to choose from the second three maintenance modes.
● MAINTENANCE 3 MODE	<ol style="list-style-type: none"> 1. Hold logo key 2. Turn machine on 3. Hold logo key for 15 seconds 4. Release logo key 5. Press and release logo key 3 times. 	<ol style="list-style-type: none"> 1. Self Test mode 2. Display maint. mode 3. Enable maint. mode 4. No function 5. No function 6. No function 	This mode allows the operator to choose from the last two maintenance modes, or exiting to the idle mode.
● MAINTENANCE 4 MODE	<ol style="list-style-type: none"> 1. Hold logo key 2. Turn machine on 3. Hold logo key for 15 seconds 4. Release logo key 5. Press and release logo key 4 times. 	<ol style="list-style-type: none"> 1. Language select 2. Enable sweep 3. Restrict pressure 4. No function 5. No function 6. No function 	Pressing button 1 will cause the machine to scroll through the different language options.
● MAINTENANCE 5 MODE	<ol style="list-style-type: none"> 1. Hold logo key 2. Turn machine on 3. Hold logo key for 15 seconds 4. Release logo key 5. Press and release logo key 5 times. 	<ol style="list-style-type: none"> 1. Software rev level 2. No function 3. No function 4. No function 5. No function 6. Exit to normal mode 	The software rev level is displayed near switch 2.
● MANUAL MODE "MAN" INDICATED ON GRAPHIC DISPLAY	Select Manual Mode from Maintenance 1 screen	Operator can use the logo button to scroll through the various operating modes and select individual functions.	Manually operate discrete functions without interlocks.

Continued on next page.

8300 MAINTENANCE MODES (continued)

MAINTENANCE MODE	ENTRY SEQUENCE	FUNCTIONS AVAILABLE	DESCRIPTION
● INPUT DISPLAY MODE	Select the Input Display mode from the Maintenance 2 screen		Display the state of floats, limit switches, and sensors. This mode enables a special display that indicates the various float and input switch levels. The operator can operate the machine in input display mode by scrolling to the operating modes, engaging the desired functions, and scrolling back to the input display mode.
● SELF TEST MODE	Select the Self Test mode from the maintenance 3 screen		This function tests the output portion of the controller board.
● ADJUST TIME MODE	Select Adjust Time from the maintenance 2 screen	<ol style="list-style-type: none"> 1. Increment segment 2. Decrement segment 3. Select 24/12 hour clock 4. Move cursor right 5. Move cursor left 6. No function 	Set the on board clock and calendar.
● DISPLAY MAINTENANCE MODE	Select Check maintenance from the maintenance 2 screen	<ol style="list-style-type: none"> 1. No function 2. No function 3. No function 4. Clear maint. timer 5. No function 6. No function LOGO - select next maint. item	Check various maintenance timers.
● RESTRICT PRESSURE MODE	Select the Restrict Pressure mode from the maintenance 4 screen	<ol style="list-style-type: none"> 1. Toggles on/off 	Allows restriction of brush down pressure settings to the lightest two.
● LANGUAGE SELECT MODE	Select the Language Select from the maintenance 4 screen	<ol style="list-style-type: none"> 1. Toggles on/off 	Allows technician to scroll thru 12 languages.
● ENABLE SWEEP MODE	Select the Enable Sweep from the maintenance 4 screen	<ol style="list-style-type: none"> 1. Toggles on/off 	Enable or disable sweeper function. Sweep icon will appear on LCD screen if engaged. This function extends self test to sweep system.

ELECTRICAL

INTERLOCKS:

The operator can start and stop the various functions of the 8300 using a variety of switch closures and interlocks. What follows are two tables for each of the basic functions. One table lists the action that are required for the basic function to be running. The other table lists the actions that would prevent the operation from running. *If the operator satisfies all of the requirements from the first table, and none of the situations of the second table exist, the operator could expect the function to operate.*

SCRUB BRUSH AND SOLUTION FLOW VALVE OPERATION ENABLED

Scrub brush operation enabled by:	Indicator
<ul style="list-style-type: none">Scrub button	<ul style="list-style-type: none">Scrub icon visible with LED illuminated
<ul style="list-style-type: none">Forward propel	<ul style="list-style-type: none">Forward sensed

SCRUB BRUSH AND SOLUTION FLOW VALVE OPERATION INHIBITED

Scrub brush operation inhibited by:	Indicator
<ul style="list-style-type: none">Scrub button	<ul style="list-style-type: none">Scrub icon visible with LED extinguished
<ul style="list-style-type: none">Neutral or Reverse	<ul style="list-style-type: none">Forward/reverse not sensed
<ul style="list-style-type: none">Full recovery tank	<ul style="list-style-type: none">Recovery tank full icon visible
<ul style="list-style-type: none">Low battery	<ul style="list-style-type: none">Blinking inverted battery icon
<ul style="list-style-type: none">No brush current sensed	<ul style="list-style-type: none">Blinking circuit breaker icon

SQUEEGEE AND VACUUM FAN OPERATION ENABLED

Squeegee operation enabled by:	Indicator
<ul style="list-style-type: none">Scrub button or Squeegee button	<ul style="list-style-type: none">Squeegee icon visible with LED illuminated
<ul style="list-style-type: none">Forward or Neutral	<ul style="list-style-type: none">Reverse not sensed

SQUEEGEE AND VACUUM FAN OPERATION INHIBITED

Squeegee operation inhibited by:	Indicator
<ul style="list-style-type: none">Scrub button or Squeegee button	<ul style="list-style-type: none">Squeegee icon visible with LED extinguished
<ul style="list-style-type: none">Reverse	<ul style="list-style-type: none">Reverse sensed
<ul style="list-style-type: none">Full recovery tank	<ul style="list-style-type: none">Recovery Tank full icon visible
<ul style="list-style-type: none">Low battery	<ul style="list-style-type: none">Blinking inverted battery icon

ES™ PUMP OPERATION ENABLED

ES™ pump operation enabled by:	Indicator
<ul style="list-style-type: none"> ES™ button 	<ul style="list-style-type: none"> ES™ icon visible with LED illuminated
<ul style="list-style-type: none"> Recovery tank full 	<ul style="list-style-type: none"> Float is covered for 5-8 seconds <p><i>NOTE: ES™ pump will operate until full float is uncovered for 30 seconds, or until solution tank full float is covered</i></p>

ES™ PUMP OPERATION INHIBITED

ES™ pump operation inhibited by:	Indicator
<ul style="list-style-type: none"> ES™ button 	<ul style="list-style-type: none"> ES™ icon visible with LED extinguished
<ul style="list-style-type: none"> More than 30 seconds has passed since the ES™ float has become uncovered 	<ul style="list-style-type: none"> None
<ul style="list-style-type: none"> Solution Tank Full float covered for more than 5 seconds 	<ul style="list-style-type: none"> None
<ul style="list-style-type: none"> Recovery tank low 	<ul style="list-style-type: none"> Icon blinks

SWEEP BRUSH OPERATION ENABLED

Sweep brush operation enabled by:	Indicator
<ul style="list-style-type: none"> Sweep button 	<ul style="list-style-type: none"> Sweep icon visible and LED illuminated
<ul style="list-style-type: none"> Forward or Reverse sensed 	<ul style="list-style-type: none"> None

SWEEP BRUSH OPERATION INHIBITED

Sweep brush operation inhibited by:	Indicator
<ul style="list-style-type: none"> Sweep button 	<ul style="list-style-type: none"> Sweep icon visible and LED extinguished
<ul style="list-style-type: none"> Hopper down switch 	<ul style="list-style-type: none"> Hopper up, hopper up icon visible
<ul style="list-style-type: none"> Forward or Reverse not sensed for 5 seconds 	<ul style="list-style-type: none"> Neutral
<ul style="list-style-type: none"> Thermal Sentry switch closed 	<ul style="list-style-type: none"> Fire icon displayed (fire sensed in hopper)

ELECTRICAL

SWEEP FAN OPERATION ENABLED

Sweep fan operation enabled by:	Indicator
● Sweep button	● Sweep icon visible and LED illuminated
● Fan button	● Fan icon visible and LED illuminated
● Forward or Reverse sensed	● None

SWEEP FAN OPERATION INHIBITED

Sweep fan operation inhibited by:	Indicator
● Fan button	● Fan icon visible and LED extinguished
● Hopper down switch	● Hopper up, hopper up icon visible
● Hopper Thermal Switch	● Hopper temperature light
● Forward or Reverse not sensed for 5 seconds	● Neutral

SIDE BRUSH OPERATION ENABLED

Side brush operation enabled by:	Indicator
● Side Brush button	● Side brush icon visible and LED illuminated
● Sweep button	● Sweep icon visible and LED illuminated
● Forward or Reverse sensed	● None

SIDE BRUSH OPERATION INHIBITED

Side brush operation inhibited by:	Indicator
● Sweep button	● Sweep icon visible and LED extinguished
● Side brush button	● Side brush icon visible and LED extinguished
● Hopper down switch	● Hopper up, Hopper up icon visible
● Hopper Thermal Sentry	● Hopper temperature light
● Forward or Reverse not sensed for 5 seconds	● Neutral

SOLUTION TANK AUTOFILL VALVE ENABLED

Solution tank autofill valve enabled by:	Indicator
• Solution tank full float is inactive	• None
• Machine in neutral	• None
• Key switch is on	• None

SOLUTION TANK AUTOFILL VALVE DISABLED

Solution tank autofill valve disabled by:	Indicator
• Solution tank full float is active	• None
• Machine in forward or reverse	• Forward or reverse sensed
• Key switch is off	• None

RECOVERY TANK AUTOFILL VALVE ENABLED

Recovery tank autofill valve enabled by:	Indicator
• Recovery tank full float is inactive	• None
• Machine in neutral	• None
• Key switch is on	• None

RECOVERY TANK AUTOFILL VALVE DISABLED

Recovery tank autofill valve disabled by:	Indicator
• Recovery tank full float is active	• None
• Machine in forward or reverse	• Forward or reverse sensed
• Key switch is off	• None

HOPPER LIFT SOLENOID ENABLED

Hopper lift solenoid enabled by:	Indicator
• Hopper lift button	• Hopper lift LED illuminated

HOPPER LOWER SOLENOID ENABLED

Hopper lower solenoid enabled by:	Indicator
• Hopper lower button	• Hopper lower LED illuminated

HOPPER LOWER SOLENOID DISABLED

Hopper lower solenoid enabled by:	Indicator
• Hopper lower button	• Hopper lower LED extinguished
• Hopper at or below minimum tilt height switch	• None
• Hopper actuator in the tilt position	• Tilt actuator position is estimated using onboard timers

ELECTRICAL

HOPPER TILT OPEN/DOWN ENABLED

Hopper tilt open/down enabled by:	Indicator
<ul style="list-style-type: none">Hopper at or above minimum tilt height switch	<ul style="list-style-type: none">Hopper tilt icons visible
<ul style="list-style-type: none">Hopper tilt button selected to tilt down	<ul style="list-style-type: none">Hopper tilt LED illuminated

HOPPER TILT OPEN/DOWN DISABLED

Hopper tilt open/down disabled by:	Indicator
<ul style="list-style-type: none">Hopper below minimum tilt height switch	<ul style="list-style-type: none">Hopper tilt icons visible
<ul style="list-style-type: none">Hopper tilt button deselected	<ul style="list-style-type: none">Hopper tilt LED extinguished
<ul style="list-style-type: none">Hopper tilt down actuator stall sensed	<ul style="list-style-type: none">None

HOPPER TILT CLOSED/UP ENABLED

Hopper tilt closed/up enabled by:	Indicator
<ul style="list-style-type: none">Hopper tilt button selected to tilt up	<ul style="list-style-type: none">Hopper tilt up LED illuminated

HOPPER TILT CLOSED/UP DISABLED

Hopper tilt closed/up disabled by:	Indicator
<ul style="list-style-type: none">Hopper tilt button deselected	<ul style="list-style-type: none">Hopper tilt up LED extinguished
<ul style="list-style-type: none">Hopper tilt up actuator stall sensed	<ul style="list-style-type: none">None

DETERGENT PUMP ENABLED

Detergent pump enabled by:	Indicator
<ul style="list-style-type: none">Scrub button	<ul style="list-style-type: none">Scrub icon active on screen
<ul style="list-style-type: none">Detergent button	<ul style="list-style-type: none">1 or 2 arrows present on detergent icon
<ul style="list-style-type: none">Forward or reverse propel sensed	<ul style="list-style-type: none">None

DETERGENT PUMP DISABLED

Detergent pump disabled by:	Indicator
<ul style="list-style-type: none">Scrub button	<ul style="list-style-type: none">Scrub icon inactive on screen
<ul style="list-style-type: none">Detergent button	<ul style="list-style-type: none">X present below detergent icon
<ul style="list-style-type: none">Neutral	<ul style="list-style-type: none">Forward/reverse not sensed

SHAKER SOLENOID ENABLED

Shaker solenoid enabled by:	Indicator
<ul style="list-style-type: none"> ● Shaker button 	<ul style="list-style-type: none"> ● Scrub icon active on screen
<ul style="list-style-type: none"> ● Sweep vacuum turned off 	<ul style="list-style-type: none"> ● Sweep vacuum indicator light off

SHAKER SOLENOID DISABLED

Shaker solenoid disabled by:	Indicator
<ul style="list-style-type: none"> ● Shaker button 	<ul style="list-style-type: none"> ● Scrub icon inactive on screen
<ul style="list-style-type: none"> ● Hopper lifted 	<ul style="list-style-type: none"> ● Hopper lift switch opens

ALARM CONDITIONS

Alarm condition:	Indicator
<ul style="list-style-type: none"> ● Hopper thermal sentry 	<ul style="list-style-type: none"> ● Blinking hopper fire icon and 5 second audible alarm
<ul style="list-style-type: none"> ● Clogged scrub vacuum fan 	<ul style="list-style-type: none"> ● Blinking squeegee/vacuum icon no alarm
<ul style="list-style-type: none"> ● Low battery 	<ul style="list-style-type: none"> ● Blinking inverted battery icon and 5 second audible alarm
<ul style="list-style-type: none"> ● Tanks full (15 second) 	<ul style="list-style-type: none"> ● Autofill/blinking recovery tank full icon and 5 second audible alarm
<ul style="list-style-type: none"> ● Open scrub vacuum fan 	<ul style="list-style-type: none"> ● Blinking inverted squeegee/vacuum icon and 5 second audible alarm
<ul style="list-style-type: none"> ● Maintenance interval (15 second) 	<ul style="list-style-type: none"> ● Maintenance icon and 5 second audible alarm
<ul style="list-style-type: none"> ● Solution tank low (7300 with no ES™ option only) 	<ul style="list-style-type: none"> ● Blinking solution tank icon and 5 second audible alarm.

BASIC 8300 OPERATION

○ Each time the panel is turned on the following actions will occur:

1. The main brushes will raise.
2. The scrub vacuum fan will be turned off, and the squeegee will raise.

- **EDGE SCRUB (SCRUB, SWEEP/SCRUB MODE):**

- Pressing the Edge scrub button will toggle the Edge scrub LED.

If the machine is propelling forward in the scrub mode and the Edge scrub LED is on, the scrub head will shift into the edge scrub position. If the Edge scrub LED is off, the scrub head will return to the retracted position.

- **SQUEEGEE (SCRUB, SWEEP/SCRUB, SWEEP MODE):**

- If the squeegee LED is off, pressing the squeegee button will drop the squeegee and turn on the vacuum fan. If the squeegee LED is on, pressing the squeegee button will raise the squeegee, initiate a delay, and turn off the vacuum fan. Squeegee operation is inhibited in reverse.

- **SCRUB (SCRUB, SWEEP/SCRUB, SWEEP MODE):**

- If the machine is currently in the idle or sweep modes, pressing the scrub button will initiate the following actions:

1. If the machine is propelling forward, the main brushes will turn on and go down. The down pressure setting will be the same used during the last scrub cycle. The solution will flow at the rate determined by the water position lever.
2. If the machine is in reverse, the brushes will stay up and off.
3. If the machine goes into neutral, the brushes will stay on for a short delay, then shut off and retract.
4. If the Edge Scrub LED is on and the machine is propelling forward, the scrub head will go into the edge scrub position.
5. The scrub vacuum fan will turn on.

Continued on next page...

- SCRUB (SCRUB, SWEEP/SCRUB, SWEEP MODE): continued
 6. If the machine is not in reverse, the squeegee will go down.
 7. If the machine is in reverse, the squeegee will stay up until reverse is no longer sensed.
 8. If the detergent LED is illuminated, and the machine is in forward, the detergent pump will run. The detergent pump will run at its slow rate if one arrow is present on the detergent icon. The detergent pump will run at its fast rate if two arrows are present on the detergent icon.
 - ☞ If the operator pushes and holds the scrub button, the pressure settings will begin to scroll. The pressure setting displayed after releasing the scrub button will become the new default down pressure setting. If the scrub function is active and one of the following occurs:
 - A. Operator pushes, then releases the scrub button.
 - B. Low battery condition sensed.
 - C. Overflow condition sensed.
- The following actions will occur:
 1. The main brushes will turn off and rise.
 2. The edge scrub will turn off and retract.
 3. The solution flow will turn off.
 4. The detergent pump will turn off.
 5. A 7 second delay will pass, and the squeegee will rise.
 6. Another 4 second delay will pass and the vacuum fan will turn off.

NOTE: If neutral is sensed for several seconds, the brushes turn off.

- DETERGENT (SCRUB MODE):

- Pressing the detergent button will toggle the function on and off. Holding the detergent button will cause the display to scroll through its two speeds. The detergent pump will run only if the main scrub brushes are active and the machine is propelling forward.

1. OFF (No arrows present on detergent icon)

 **Detergent pump off**

2. LOW (One arrow present on detergent icon)

 **Detergent pump low**

3. HIGH (Two arrows present on detergent icon)

 **Detergent pump high**

- ES™ (SCRUB MODE):

- Pressing the ES™ button will enable or disable the ES™ function. In order for the ES™ float to become active, it must be consistently in the up position for at least 10 seconds. If the ES™ function is enabled and the ES™ float becomes active, the following actions will occur.

1. The ES™ pump will begin to run.
2. The ES™ pump will continue to run for 30 seconds after the ES™ float becomes uncovered, or until the solution tank full float becomes covered.

- OVERFLOW (SCRUB MODE, SWEEP/SCRUB MODE):

- In order for the recovery tank float to become active, it must be consistently in the up position for at least 10 seconds. If the scrub or vacuum fan are active and the tank full float becomes active the overflow icon will appear, the audible alarm will sound for 5 seconds, and the scrub and squeegee functions will be canceled. The overflow icon will not turn off by simply emptying the recovery tank. The scrub or squeegee buttons must be pressed, or the key switch must be cycled.

- MAIN SWEEP BRUSH (SWEEP MODE, SWEEP/SCRUB MODE):

- If the operator presses the sweep button while the hopper is down, the thermal sentry is not sensed, and propel is sensed, the following actions will take place:

1. The sweep brush will turn on and lower.
2. The sweep vacuum fan will start.
3. The side brush will turn on and lower.

- If the sweep system is activated and the operator presses then releases the sweep button, or the hopper is lifted, or the thermal sentry switch is activated, the following actions will take place:

1. The sweep brush will turn off and lift.
2. The sweep vacuum fan will shut off.
3. The side brush will turn off and rise.

- *Note: If neutral is sensed for several seconds, the brushes turn off.*

- SIDE SWEEP BRUSH (SWEEP MODE, SWEEP/SCRUB MODE):

- The side brush is automatically engaged each time the sweep system is turned on. The side brush can be disengaged by pressing the side brush button after pressing the sweep button.

- HOPPER UP/DOWN:

- The hopper will raise or lower anytime the hopper up or hopper down buttons are activated.

☞ When the hopper is lifted the sweep functions are disabled.

☞ The sweep brush turns off and lifts.

☞ The side brushes turn off and lift.

☞ The sweep vacuum fan turns off.

☞ The shaker system will not do an automatic shake when the hopper is lifted.

- The hopper will not lower beyond the minimum tilt height position until the hopper has been tilted up.

NOTE: The hopper will tilt back automatically if the hopper button is held. Then the hopper will continue to lower.

- HOPPER TILT DOWN:

- The hopper will tilt down anytime the hopper tilt down button is activated, if the hopper is lifted above the minimum tilt height position.

- ☞ The hopper will not lower beyond the minimum tilt height position until the hopper has been tilted up.

- HOPPER TILT UP:

- The hopper will tilt up anytime the hopper tilt up button is activated, if the hopper is lifted above the minimum tilt height position.

- ☞ The hopper will tilt up automatically if the operator tries to lower the hopper below the minimum tilt height position.

- FILTER SHAKER:

- The Filter Shaker button controls the operation of the filter shaker timer system.

- ☞ If the Filter Shaker LED is off, pressing the shaker button will initiate a shake sequence. A shake sequence is defined as follows:

1. The Shaker LED will turn on.
2. The sweep fan will turn off.
3. The filter shaker will start.
4. The filter shaker and LED will remain on for approximately 10 seconds.
5. The filter shaker and LED will turn off.
6. If the sweep fan was engaged before the shake cycle, it will turn on.

- ☞ If the Filter Shaker LED is on, pressing the shaker button will turn off the Shaker motor and LED.

- ☞ A 10 second shake sequence will also be initiated each time the sweep fan is turned off.

- ☞ A shake sequence will be cancelled if active while the sweep or sweep vacuum fan is turned on.

- ☞ A shake sequence will be cancelled if active, if the hopper is lifted.

- VACUUM FAN:

- The sweep vacuum fan is activated and deactivated with the sweep system. Pressing the sweep vacuum fan button will enable or disable the fan operation while sweeping.

- ☞ The sweep fan will only operate if the sweep function is engaged.

- ☞ Each time the sweep function is engaged, the fan will be enabled.

- ☞ Each time the sweep function is turned off, the fan will be cancelled, except when the sweep function is cancelled for lifting the hopper.

- ☞ If the vacuum fan is enabled, and the hopper thermal switch closes, the fan will shut off.

- ☞ If the vacuum fan is enabled, and the hopper is lifted, the fan will shut off.

MAINTENANCE MODES

The 8300 front panel has a total of eight maintenance modes. The operator can access the maintenance modes by turning the machine off, pressing and holding the button inside the Tennant logo, turning the machine on, holding the button for about 15 seconds, and releasing it. At that point, the panel will display the maintenance modes (three at a time). The operator can scroll through the maintenance modes using the logo button.

Operating Modes	Entry Sequence (how to activate)
Manual Mode; <i>Manually operate discrete functions without interlocks.</i> More info pages 5-104 thru 5-106	<ol style="list-style-type: none">1. Turn off the machine2. Press and hold the logo button3. Turn on the machine4. Hold the logo button for 15 seconds5. Release the logo button6. Select Manual mode
Input Display Mode; <i>Display the state of floats, limit switches, and sensors.</i> More info page 5-107	<ol style="list-style-type: none">1. Turn off the machine2. Press and hold the logo button3. Turn on the machine4. Hold the logo button for 15 seconds5. Release the logo button6. Press and release the logo button7. Select Input mode
Self Test Mode; <i>Checks normal operation.</i> More info page 5-108	<ol style="list-style-type: none">1. Turn off the machine2. Press and hold the logo button3. Turn on the machine4. Hold the logo button for 15 seconds5. Release the logo button6. Press and release the logo button twice7. Select Self Test mode
Time Adjust Mode; <i>This mode is used to set the internal clock.</i> More info page 5-109	<ol style="list-style-type: none">1. Turn off the machine2. Press and hold the logo button3. Turn on the machine4. Hold the logo button for 15 seconds5. Release the logo button6. Press and release the logo button7. Press the Set Clock button

Operating Mode	Entry Sequence (how to activate)
Manual Mode; <i>Manually operate discrete functions without interlocks.</i>	<ol style="list-style-type: none"> 1. Turn off the machine 2. Press and hold the logo button 3. Turn on the machine 4. Hold the logo button for 15 seconds 5. Release the logo button 6. Select Manual mode

MANUAL MODE

In this mode, the operator can turn on and off accessories individually and manually. In the manual mode, the operator can turn on accessories without regard to inputs or interlocks. If, for instance, the operator enables the ES™ pump in the manual mode, it will run regardless of whether or not the ES™ float is in the water.

- TO INITIATE:

1. Turn off the machine.
2. Press and hold the logo button.
3. Turn on the machine.
4. Hold the logo button for 15 seconds.
5. Release the logo button.
6. Select Manual mode.

- OPERATION:

- ☞ All of the following operations are accessed by scrolling to the appropriate screen using the logo button.
 - ☐ ES™ (scrub mode):
Pressing the ES™ button in the manual mode turns on and off the ES™ pump.
 - ☐ EDGE SCRUB BUTTON (scrub mode):
Pressing the Edge Scrub button will extend or retract the scrub head.

Continued on next page.....

Continued from previous page....

■ OPERATION:

□ SQUEEGEE BUTTON

(scrub mode, sweep mode):

Pressing the Squeegee button will turn on the vacuum fan and lower the squeegee. Reverse is ignored.

□ SCRUB BUTTON

(idle, scrub, and sweep mode):

Pressing the Scrub button will turn on and lower the main scrub head. The brush head actuator will continue to lower until the scrub button is released. Reactivating the scrub button will turn off the scrub brushes and raise the head.

NOTE: DO NOT hold the button long enough to drive the brush into the ground. The actuator could be damaged.

□ DETERGENT BUTTON

(scrub mode):

Pressing the Detergent button will cause the detergent LED's to scroll. If no LED's are on, the detergent pump will be off. If one LED is illuminated, the detergent pump will run in low speed. If both LED's are on, the detergent pump will run in high speed. The water valve will also turn on whenever the detergent pump is running.

□ SWEEP BUTTON

(sweep mode):

Pressing the Sweep button will turn on and lower the sweep brush. The brush head actuator will continue to lower until the sweep button is released. Reactivating the sweep button will turn off the sweep brushes and raise the head.

NOTE: DO NOT hold the button long enough to drive the brush into the ground. The actuator could be damaged.

Continued on next page.....

Continued from previous page....

■ **OPERATION:**

□ **SIDE BRUSH BUTTON**

(sweep mode):

Pressing the Side brush button will turn on and lower the side brushes. The brush head actuator will continue to lower until the side brush button is released.

Reactivating the side brush button will turn off the side brushes and raise the head.

NOTE: DO NOT hold the button long enough to drive the brush into the ground. The actuator could be damaged.

□ **VACUUM FAN BUTTON**

(sweep mode):

Pressing the Vacuum fan button will turn on or off the sweep vacuum fan. The hopper down switch no longer influences the operation of this device.

□ **SHAKER BUTTON**

(sweep mode):

Pressing the Shaker button will turn on or off the filter shaker.

ELECTRICAL

Operating Mode	Entry Sequence (how to activate)
Input Display Mode; <i>Display the state of floats, limit switches, and sensors.</i>	<ol style="list-style-type: none"> 1. Turn off the machine 2. Press and hold the logo button 3. Turn on the machine 4. Hold the logo button for 15 seconds 5. Release the logo button 6. Press and release the logo button 7. Select Input mode

INPUT DISPLAY MODE

In this mode, the operator can observe whether or not inputs to the panel are operating as intended. In the Input display mode, the LED's on the instrument panel, and the graphics screen, display the state if each input to the controller board.

- TO INITIATE:

1. Turn off the machine.
2. Press and hold the logo button.
3. Turn on the machine.
4. Hold the logo button for 15 seconds.
5. Release the logo button.
6. Press and release the logo button.
7. Select Input mode.

PANEL LED	INPUT SIGNAL
ES™ ICON AND LED	ES FLOAT
OVERFLOW ICON AND LED	FULL RECOVERY TANK
LEFT ARROW	REVERSE LIMIT SWITCH
RIGHT ARROW	FORWARD LIMIT SWITCH
SHAKER LED	CLOGGED SWEEP FILTER
SOLUTION FULL ICON AND LED	SOLUTION FULL FLOAT
HOPPER UP/DOWN ICON	HOPPER UP SWITCH
HOPPER THERMAL ICON AND LED	HOPPER THERMAL SENSOR

Operating Mode	Entry Sequence (how to activate)
Self Test Mode; <i>Checks normal operation.</i>	<ol style="list-style-type: none">1. Turn off the machine2. Press and hold the logo button3. Turn on the machine4. Hold the logo button for 15 seconds5. Release the logo button6. Press and release the logo button twice7. Select Self Test mode

SELF TEST MODE

If the operator selects the Self test mode, the panel will run a self test on each output. If the panel passes the diagnostics, the OK indicator is illuminated on the graphics display. If the panel fails, the pin number of the controller connector for the failing output will be printed on the screen. The technician can use this information, in combination with the machine schematic, to determine which devices are on failing outputs. The technician should then unplug the offending device, and re-run the self test. If the OK icon now comes on, the controller board is probably good, and the device that was unplugged was probably shorted.

- TO INITIATE:

1. Turn off the machine.
2. Press and hold the logo button.
3. Turn on the machine.
4. Hold the logo button for 15 seconds.
5. Release the logo button.
6. Press and release the logo button twice.
7. Select Self Test mode.

ELECTRICAL

Operating Mode	Entry Sequence (how to activate)
Time Adjust Mode; <i>This mode is used to set the internal clock.</i>	1. Turn off the machine 2. Press and hold the logo button 3. Turn on the machine 4. Hold the logo button for 15 seconds 5. Release the logo button 6. Press and release the logo button 7. Press the Set Clock button

SET CLOCK

This mode is used to set the internal clock.

- TO INITIATE:

1. Turn off the machine.
2. Press and hold the logo button.
3. Turn on the machine.
4. Hold the logo button for 15 seconds.
5. Release the logo button.
6. Press and release the logo button.
7. Press the set clock button.

- In the Set clock mode, the touch panel functions as follows:

+ BUTTON	INCREMENT UNDERLINED SEGMENT
- BUTTON	DECREMENT UNDERLINED SEGMENT
RIGHT ARROW	SHIFT UNDERLINE TO NEXT SEGMENT ON RIGHT
LEFT ARROW	SHIFT UNDERLINE TO NEXT SEGMENT ON LEFT
12/24	SELECT 12 OR 24 HOUR CLOCK

CHECK MAINTENANCE MODE:

The check maintenance mode allows the operator to store and monitor the elapsed time between 6 different required maintenance items. Each maintenance item is represented by an icon with the recommended elapsed time interval (in hours) printed below it. The lower left corner of the screen displays the number of hours that have elapsed since this maintenance timer was last reset. The button at the upper right corner of the screen will reset the hour counter for this maintenance item. The operator can scroll through the various maintenance items by pressing the logo button.

If the operator presses the reset button each time one of these maintenance items is performed, this feature will act as an accurate maintenance log, and the reminder for the machine.

- **If the Enable maintenance button from maintenance screen 3 is activated:**

The operator will get a 10 second alert each time the machine is started, if one or more of the maintenance hour counters goes beyond the recommended interval.

ELECTRICAL

SCRUB CIRCUIT BOARD PIN FUNCTIONS

PIN NUMBER	FUNCTION	ACTIVE VOLTAGE	INACTIVE VOLTAGE
P1-1, P1-2	Input, Power	B+	0 VDC
P1-9	Input, logic power	B+	0 VDC
P2-1, 2, 3, 4, 5, 6, 7, and 8	Outputs	0 VDC	B+
P2-5	Detergent pump output	High speed - ???? (measured across the pump) Low speed - ???? volts (measured across the pump)	0 VDC across the motor.
P1-5, 6 and 10	Grounds	B-	B-
P4-7	Battery Disconnect sensed	B+ = Connected	B- = Disconnected
P3-1 and 2	Forward/Reverse sensed	B+	0 VDC
P3-3, 4, 5, 6, 7, 8, and 10	Inputs	B-	5 VDC
P4-6 and P4-3	Shunt High inputs	0 - 62.5mV (Depends on brush current level and shunt selection)	0 VDC
P4-1, 2, 4 and 5	Shunt low and shields	Ground	Ground
P1-3 and 4	Scrub Brush up/dn act	0 to approx. B+. (De- pends on act. Position.)	0 VDC across the motor
P1-7 and 8	Squeegee up/dn act.	0 to approx. B+. (De- pends on act. Position.)	0 VDC across the motor
P1-11 and 12	Edge scrub in/out act.	0 to approx. B+. (De- pends on act. Position.)	0 VDC across the motor

SWEEP CIRCUIT BOARD PIN FUNCTIONS

PIN NUMBER	FUNCTION	ACTIVE VOLTAGE	INACTIVE VOLTAGE
J1-29, J1-30	Input Power	B+	0 VDC
J1-18, J1-20	+12 VDC	+12 VDC	0 VDC
J1-22	+5 VDC	+5 VDC	0 VDC
J1-23, J1-24. J1-26, J1-27, J1-28	GROUND	0 VDC	0 VDC
J2-2, J2-3, J2-4, J2-5, J2-6, J2-8	OUTPUTS	0 VDC	B+
P2-7, J2-13	Sweep up/dn act.	0 to approx. B+. (De- pends on act. Position.)	0 VDC across the motor
P2-1, J2-12	Hopper tilt act.	0 to approx. B+. (De- pends on act. Position.)	0 VDC across the motor
P2-11, J2-15	Left side br up/dn act.	0 to approx. B+. (De- pends on act. Position.)	0 VDC across the motor
P2-10, J2-14	Right side br up/dn. act.	0 to approx. B+. (De- pends on act. Position.)	0 VDC across the motor

ELECTRICAL

POWER UP TESTING:

OPERATION:

1) Keyswitch in the start position-

Current flows into the keyswitch terminal 50.

Current flows out of the keyswitch terminal 15, turning on M1A contactor.

2) Release keyswitch to the run position-

Current flows through M1A contacts, into keyswitch pin 30.

Current flows out of keyswitch terminal 15, holding M1A contactor on, keeping the machine powered up.

3) Keyswitch to the off position-

M1 is turned off by the keyswitch or emergency switch. Machine turns off.

POWER UP TESTING

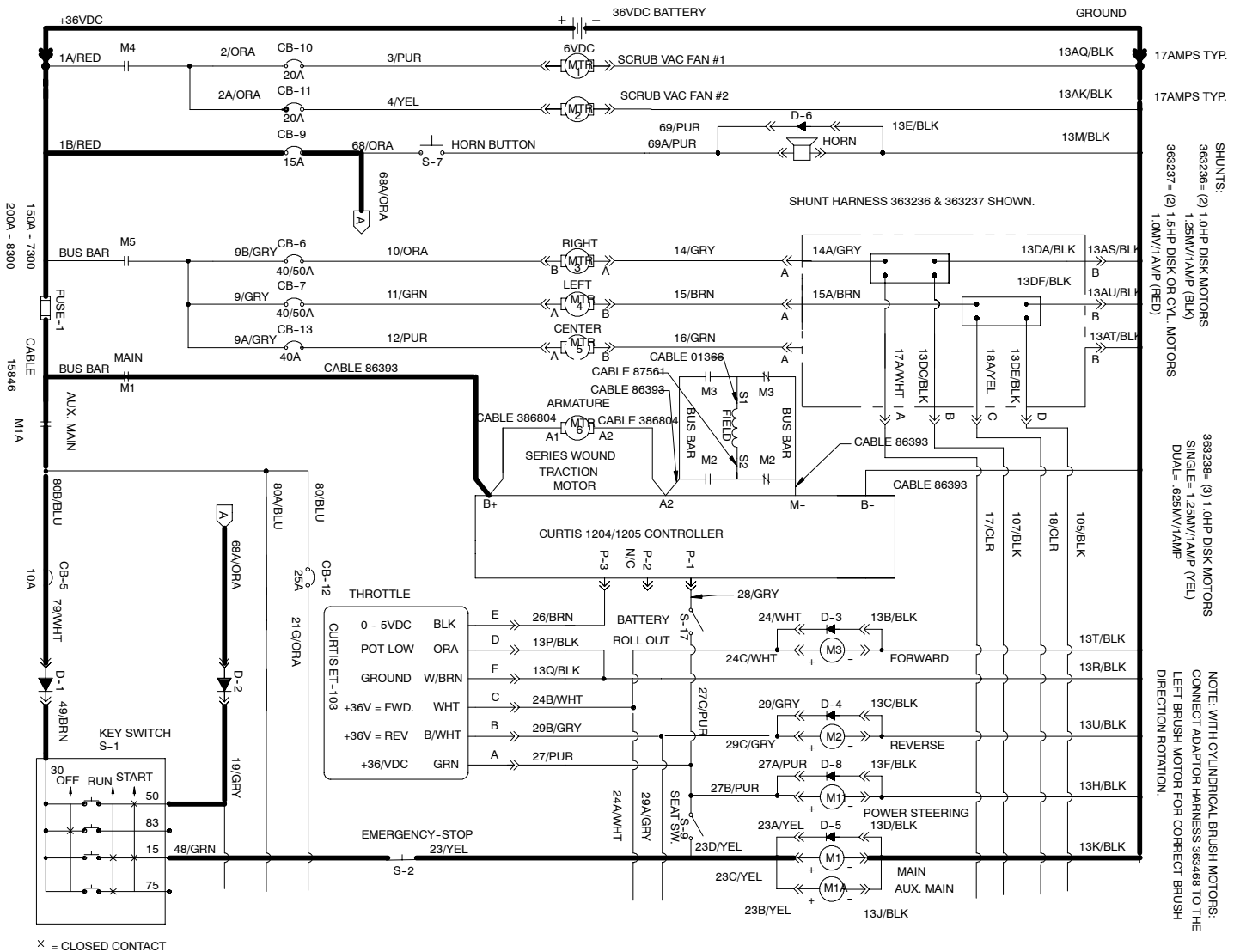

POWER UP TESTING

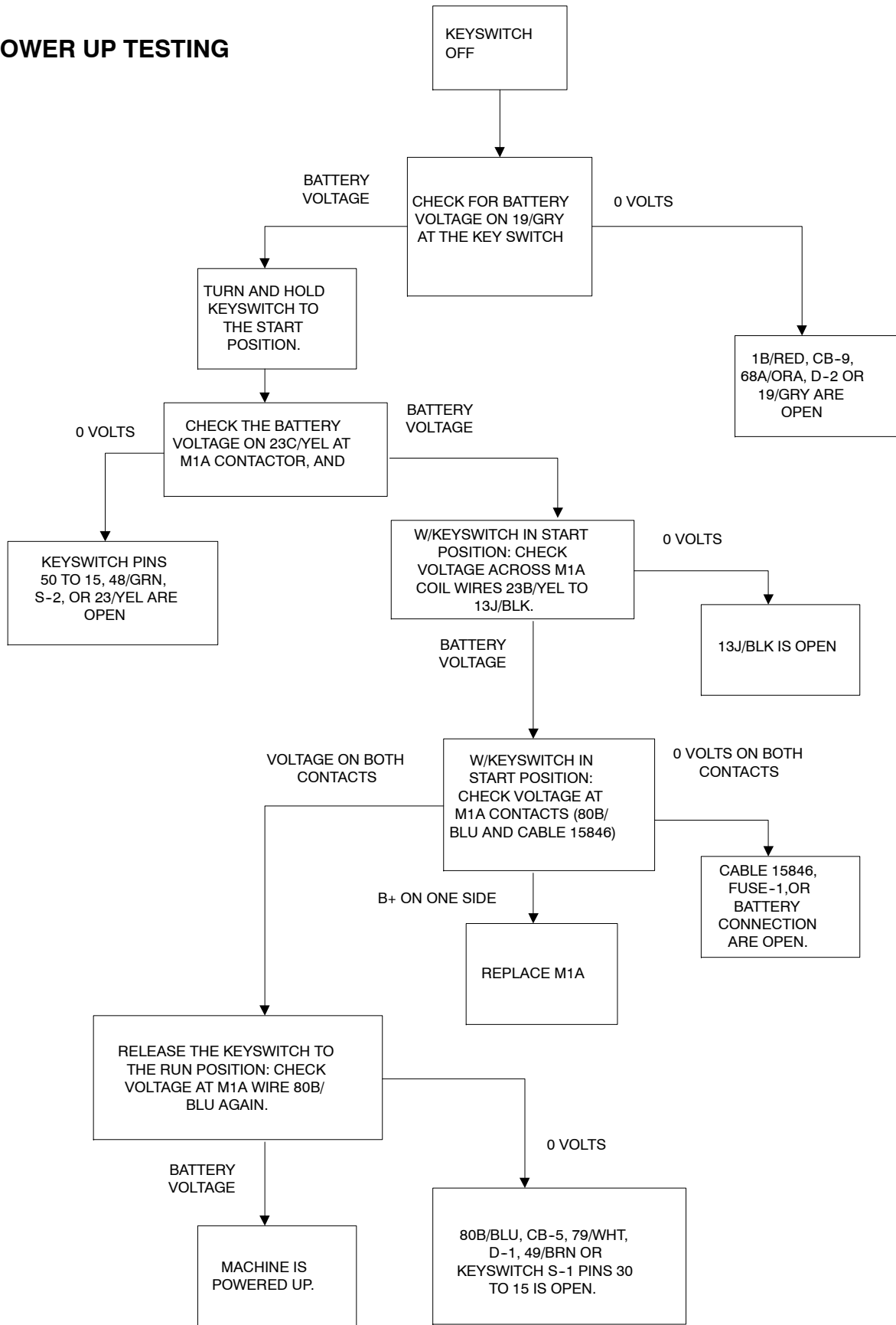

ELECTRICAL

SCRUB VACUUM FAN TESTING:

OPERATION: To enable the scrub vacuum fan the following conditions must occur:

Squeegee/Scrub Vacuum system must be selected on the touch panel. (associated LED will be on.)

Machine in neutral or forward position.

No "low battery condition" sensed.

No "full recovery condition" sensed.

VACUUM MOTOR TURNS ON:

37/GRY is switched to ground at the control board P2-2.

M4 contactor turns on, supplying power to the vacuum fans, through CB-10 and CB-11.

Note: This testing assumes that the machine powers up and propels.

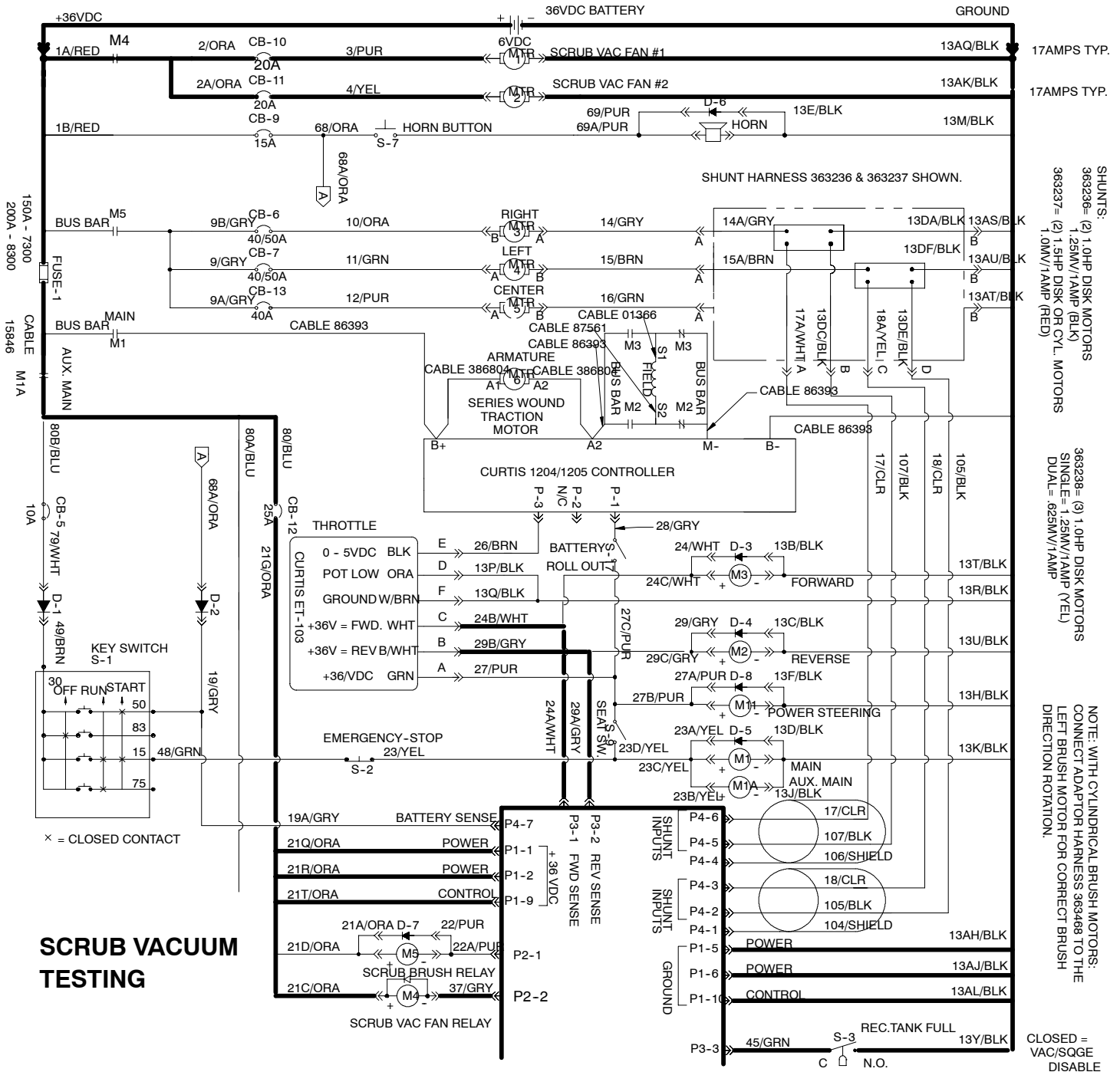

SCRUB VACUUM TESTING

NOTE: THIS TEST ASSUMES THAT THE SCRUB SYSTEM CAN BE TURNED ON, AND WILL STAY ON. IF NOT, TROUBLE SHOOT THE SCRUB SYSTEM FIRST.

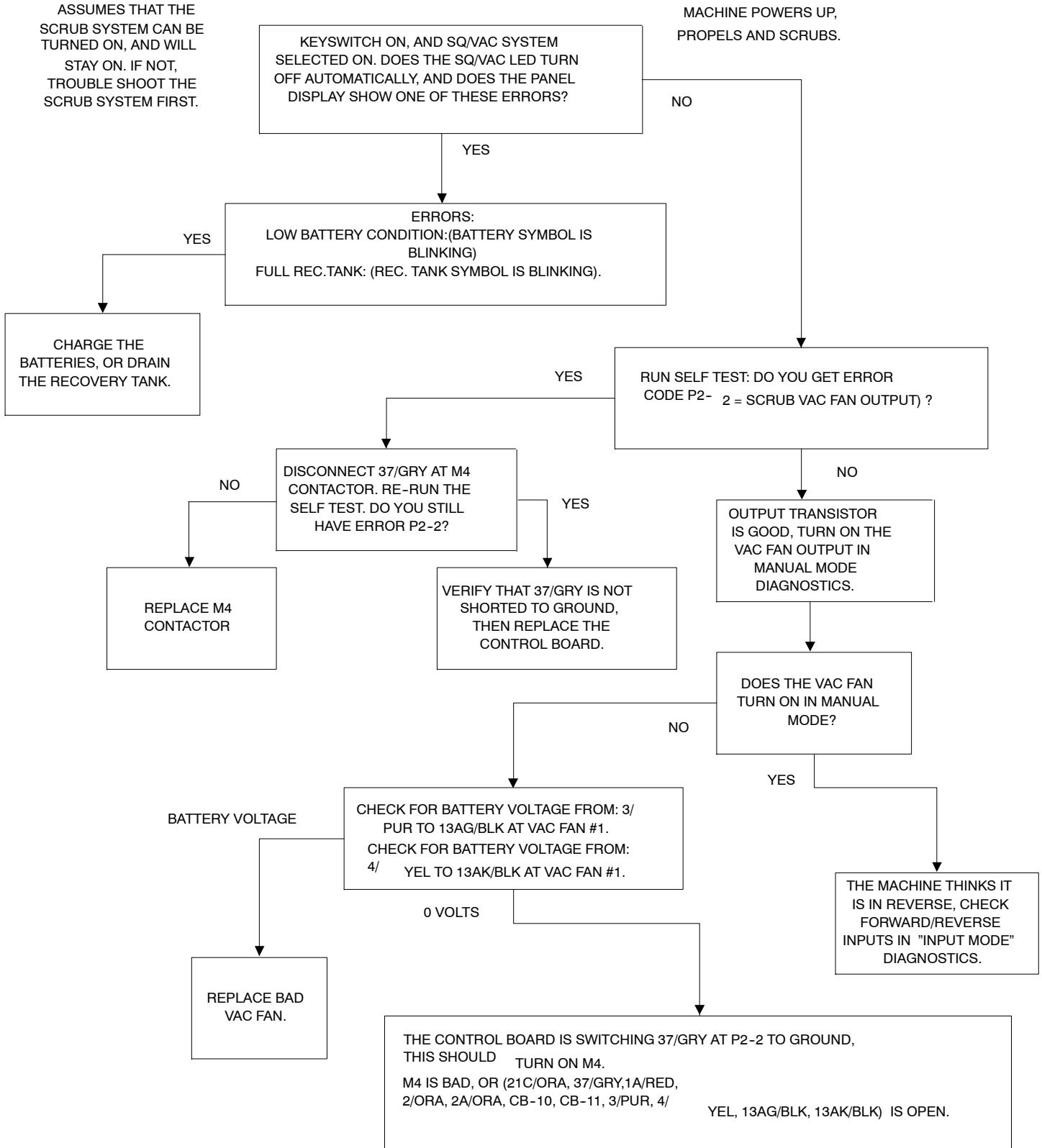

TOUCH PANEL AND RIBBON CABLE TESTING:

This test assumes that machine powers up and propels.

OPERATION OF TOUCH PANEL LED'S (LIGHTS):

P5-2 = Supplies +5VDC to each LED.

P5_25 through P5-31 will light an LED if they are pulled to ground by the control board.

OPERATION OF SWITCHES:

P5-1 and P5-16 = Supplies ground to each switch.

P5-25 = Pulled to ground by lower left switch.

P5-26 = Pulled to ground by upper right switch.

P5-27 = Pulled to ground by center right switch.

P5-28 = Pulled to ground by center left switch.

P5-29 = Pulled to ground by upper left switch.

P5-30 = Pulled to ground by lower right switch.

P5-31 = Pulled to ground by Tennant Logo switch.

See schematic on following page.

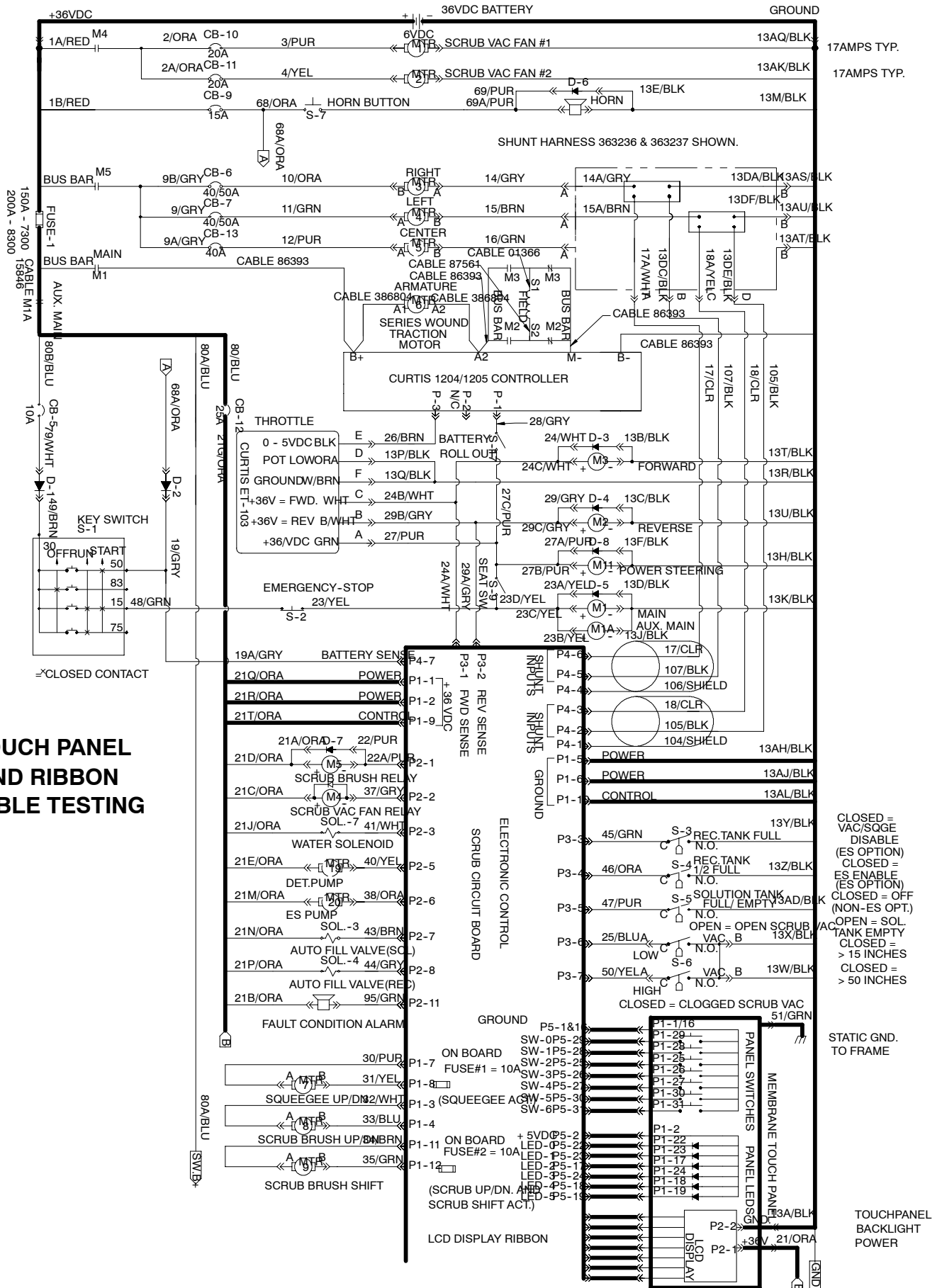

TOUCH PANEL AND RIBBON CABLE TESTING

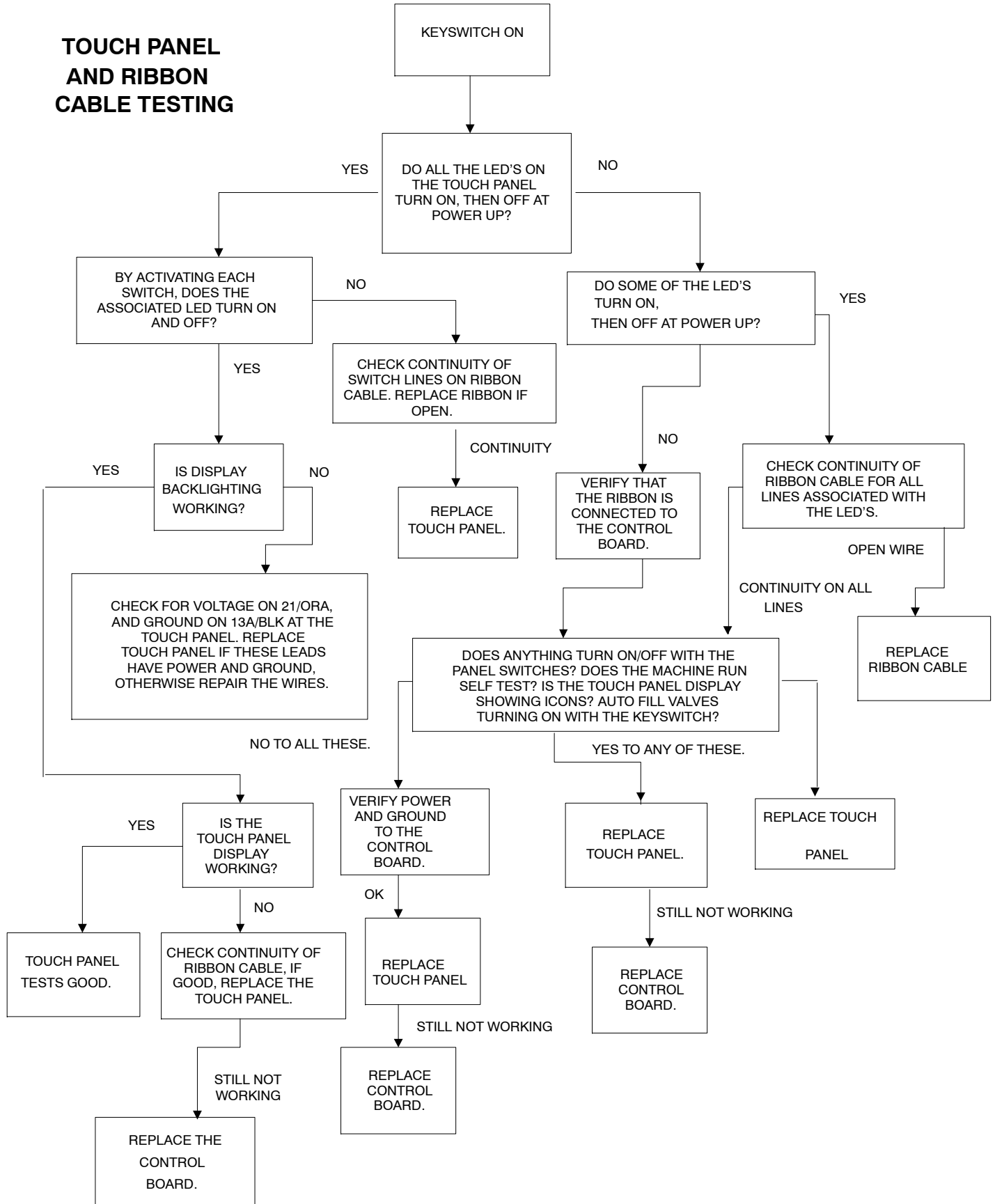

PROPEL TESTING

OPERATION:

NOTE: This test assumes that machine has passed power up testing.

M1 contactor supplies battery voltage to the Curtis motor controller, and the propel motor at power up.

M1A (aux. Main contactor) supplies battery voltage to the electronic throttle, and the logic input of the Curtis motor controller (P1).

Electronic throttle supplies voltage to the forward or reverse contactor when the pedal is activated. This will connect the motor field winding to the motor controllers output in the proper direction.

Electronic throttle will supply a variable voltage to the P3 input of the motor controller. This voltage represents the throttle positioning. (0 volts = neutral, +5VDC = full throttle)

The Curtis Motor controller power output (M-) is pulsed to ground at a high frequency(PWM controlled output). The duty cycle of this output pulsing is directly related to the throttle position. When the duty cycle of the output pulsing is increased, the propel motor turns faster and the machine speed increases.

Removing power (open: keyswitch, emergency stop switch, seat switch, battery roll out switch, CB5 , fuse-1) to the motor controller logic input (P1) will turn off the PWM output.

NOTE:

For safety reasons: Before maintenance work is done on the propel system, the machine should be jacked up with the front propel wheel off the ground.

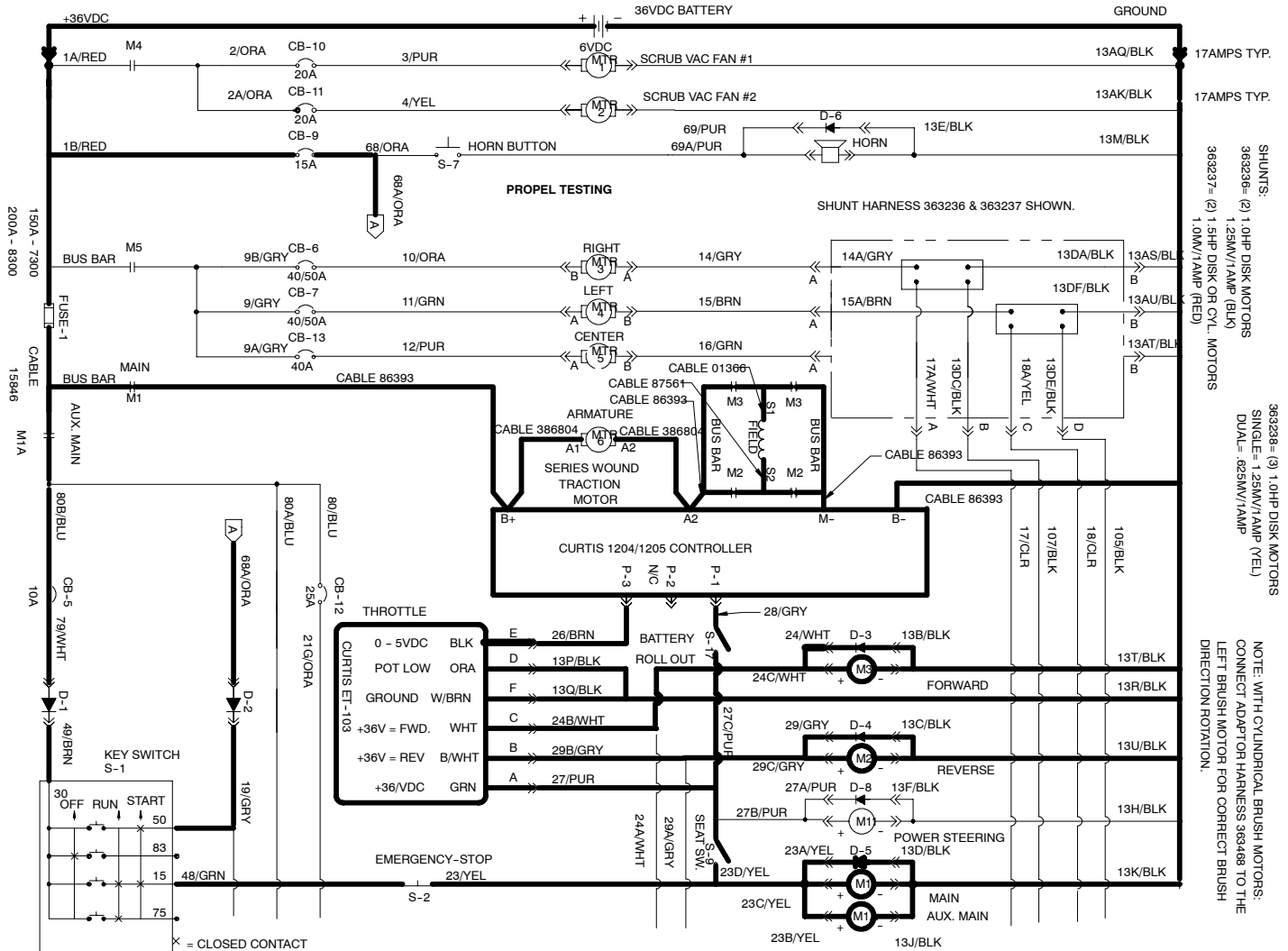

PROPEL TESTING

NOTE: THIS TEST ASSUMES THAT THE MACHINE PASSES POWER UP TESTING.

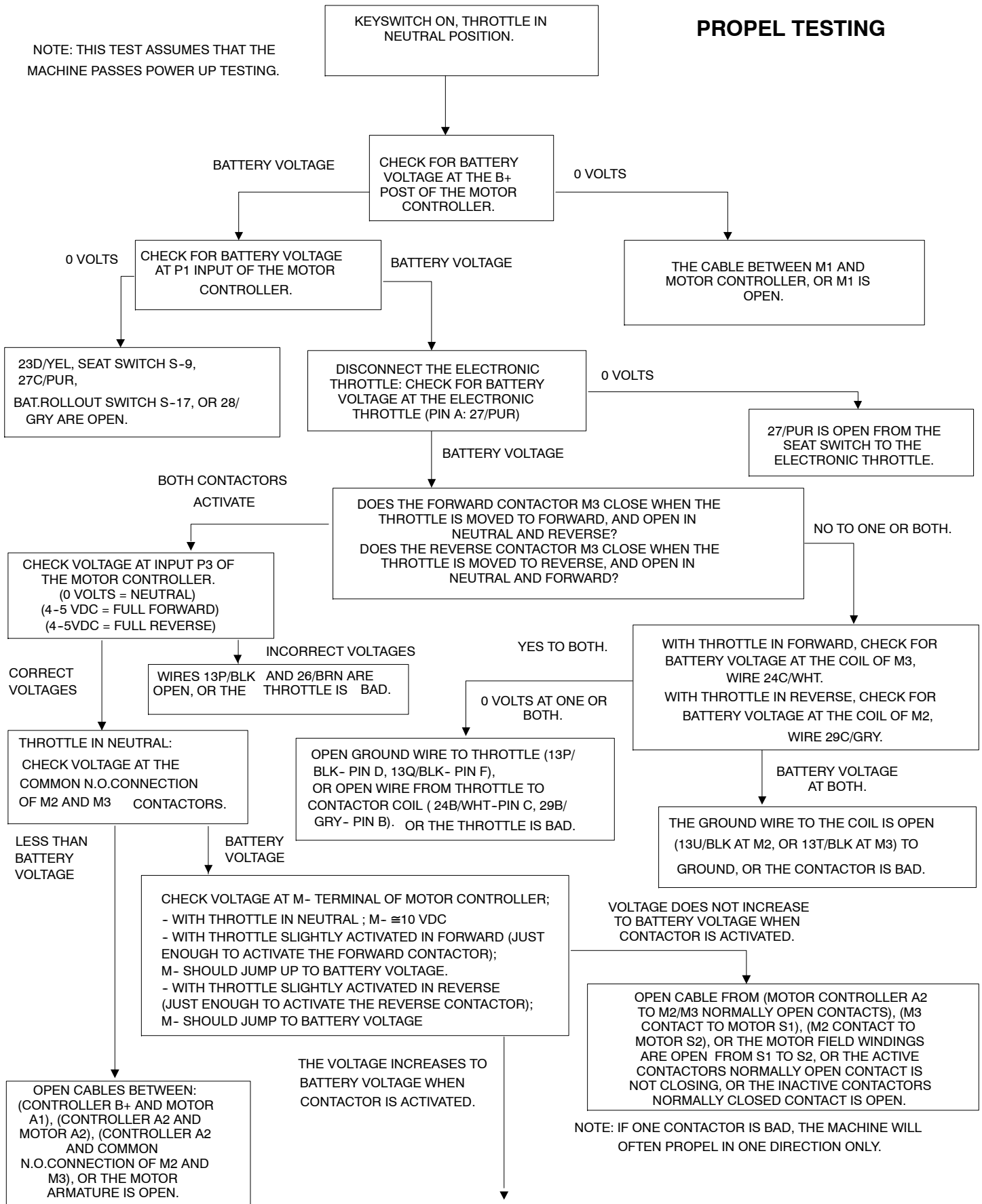

PROPEL TESTING CONTINUED

CONTINUED FROM PREVIOUS PAGE

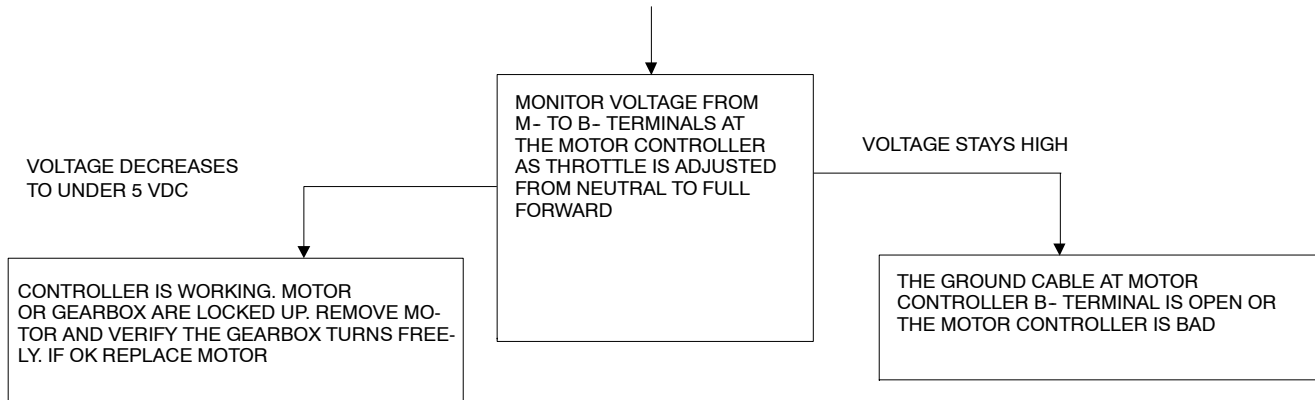

SCRUB TESTING:

OPERATION: Scrub system is selected on the touchpanel, the associated LED will turn on.

When forward propel is sensed, the system is activated.

The control board pulls 22A/PUR to ground at P2-1, turning on M5 contactor (scrub brush).

M5 contactor closes, supplying power to the (2 or 3) brush motors through CB-6,7 and 13. The brush motors turn on.

The brush motor current flows through the brush motor shunt. This shunt produces 1.25mV (1.00mV for heavy duty motors) per amp of brush current.

The control board reads the shunt signal, and lowers the brush head actuator until the desired brush current is obtained. The control board will continue to lift and lower the brush head actuator to keep the brush current in the proper amperage range.

If the machine has edge scrub option, and it has been selected, the brush head shift actuator will extend, extending the brush head out.

SYSTEM INHIBITS:

Neutral or reverse will turn off the brushes/vac and lift the head after a delay.

Full recovery tank will automatically turn off the scrub system, and flash the rec. tank icon.

Low battery will automatically turn off the scrub system, and flash the battery icon.

Sensing no current from one of the shunts will automatically turn off the scrub system, and flash a circuit breaker icon.

Note: This testing assumes that the machine powers up and propels.

See schematic on following page.

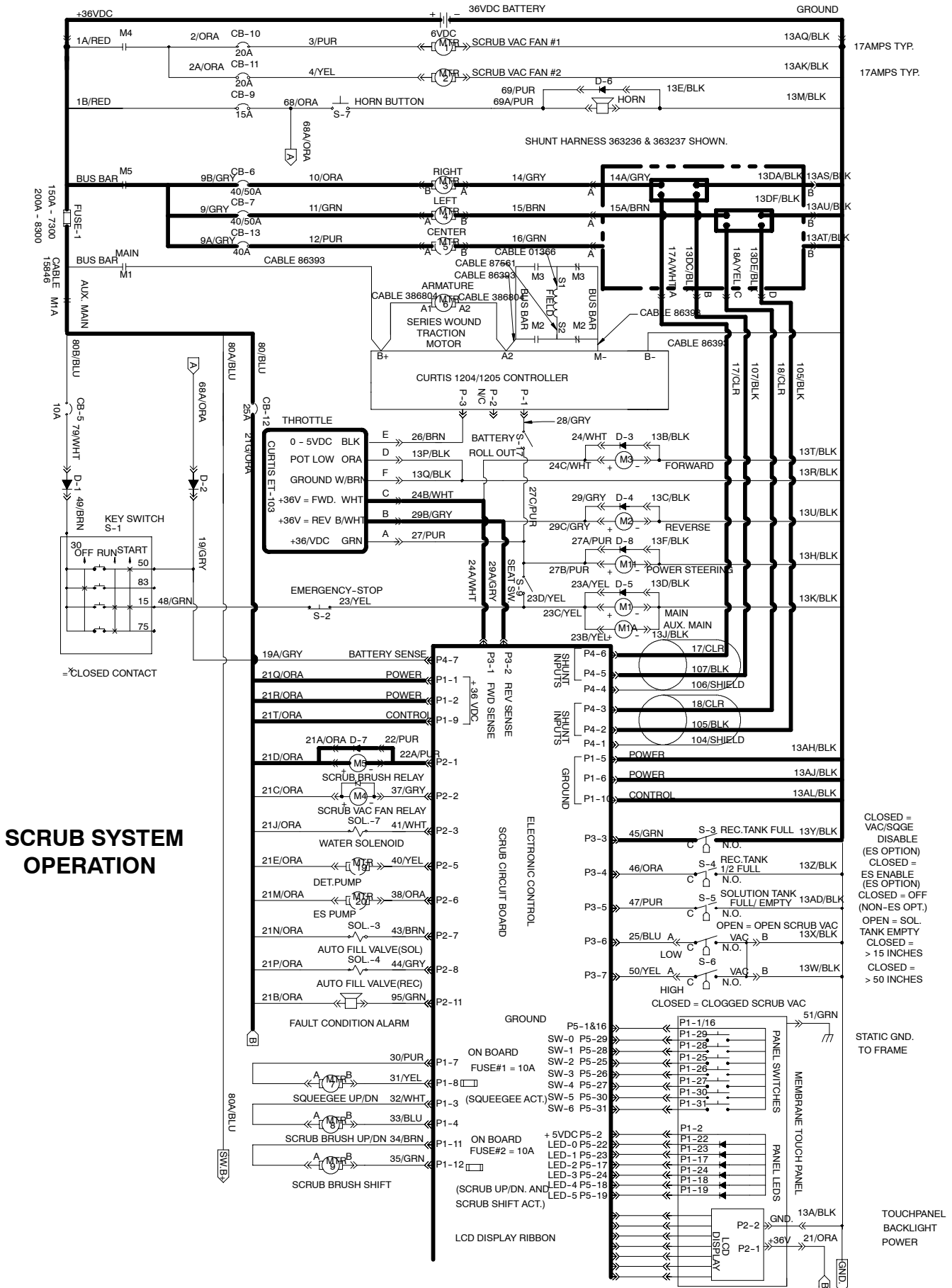

SCRUB SYSTEM OPERATION

SCRUB SYSTEM OPERATION

ASSUMES THE MACHINE POWERS UP, AND PROPELS.

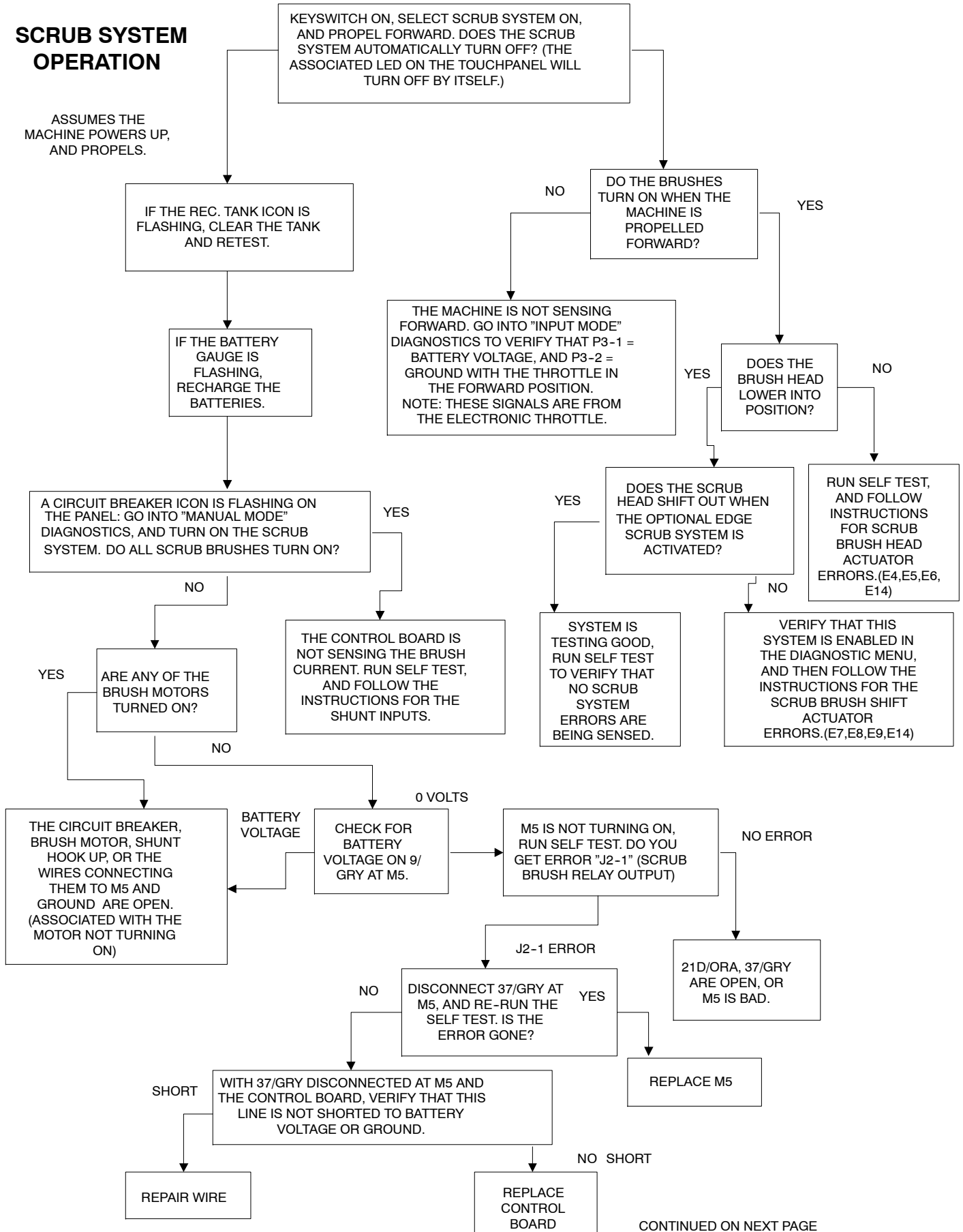

CONTINUED ON NEXT PAGE

**SCRUB SYSTEM
OPERATION**
CONTINUED

SEE PREVIOUS PAGE.

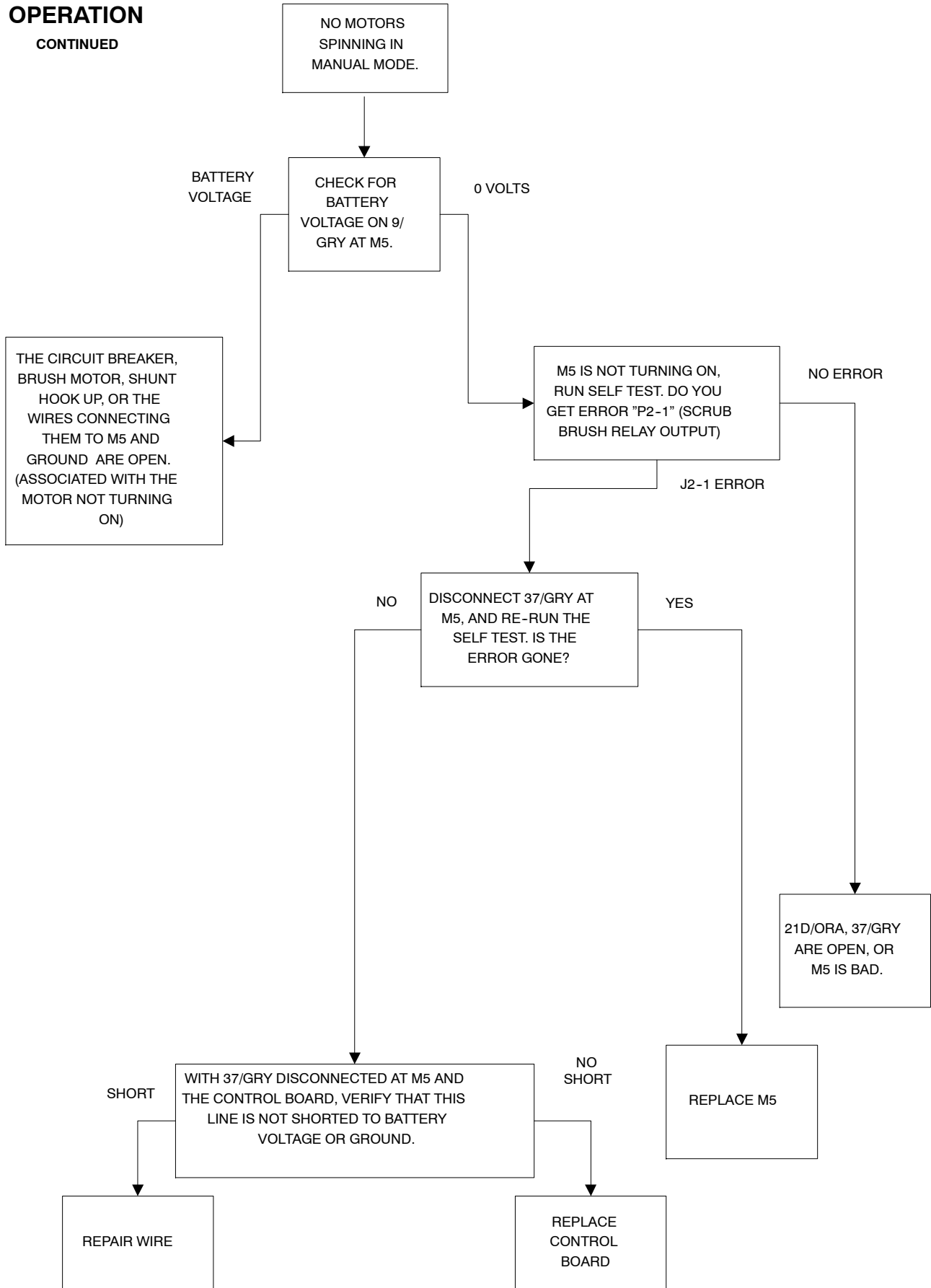

TOUCH PANEL ERROR CODES

E-4 = THE CIRCUIT BOARD IS SENSING SCRUB HEAD ACTUATOR CURRENT WITH THE ACTUATOR TURNED OFF. REPLACE THE CONTROL BOARD.

E-5 = STALLED OR JAMMED SCRUB HEAD ACTUATOR. VERIFY THAT 32/WHT AND 33/BLU ARE NOT SHORTED TOGETHER, THEN REPLACE THE SCRUB HEAD UP DOWN ACTUATOR.

E-6 = OPEN SCRUB HEAD ACTUATOR. VERIFY THAT 32/WHT AND 33/BLU ARE NOT OPEN, THEN REPLACE THE SCRUB HEAD ACTUATOR.

E-7 = THE CIRCUIT BOARD IS SENSING SCRUB SHIFT ACTUATOR CURRENT WITH THE ACTUATOR TURNED OFF. REPLACE THE CONTROL BOARD.

E-8 = STALLED OR JAMMED SCRUB SHIFT ACTUATOR. VERIFY THAT 34/BRN AND 35/GRN ARE NOT SHORTED TOGETHER, THEN REPLACE THE SCRUB SHIFT ACTUATOR.

E-9 = OPEN SCRUB SHIFT ACTUATOR. VERIFY THAT 34/BRN AND 35/GRN ARE NOT OPEN, THEN REPLACE THE SCRUB SHIFT ACTUATOR.

E-14 = OPEN FUSE 2 ON CONTROL BOARD. BRUSH HEAD OR EDGE SHIFT ACTUATOR IS DRAWING EXCESSIVE CURRENT, OR THE CONTROL BOARD OUTPUT IS BAD. GO TO MANUAL MODE, THEN PUT IN A NEW FUSE. LOWER AND EXTEND THE THE BRUSH HEAD, AND REPLACE WHICHEVER ACTUATOR CAUSES THE FUSE TO BLOW AGAIN. IF IT STILL BLOWS A FUSE, REPLACE THE CONTROL BOARD.

NOTE: FUSE 1 AND FUSE 2 ARE LOCATED ON THE SCRUBBING CIRCUIT BOARD. THE CIRCUIT BOARD IS LOCATED IN THE SMALL CONTROL PANEL AT THE LEFT OF THE STEERING COLUMN

CONTINUED ON NEXT PAGE

TOUCH PANEL ERROR CODES

E-1 = THE CIRCUIT BOARD IS SENSING SQUEEGEE ACTUATOR CURRENT WITH THE ACTUATOR TURNED OFF. REPLACE THE CONTROL BOARD.

E-2 = STALLED OR JAMMED ACTUATOR. VERIFY THAT 30/PUR AND 31/YEL ARE NOT SHORTED TOGETHER, THEN REPLACE THE SQUEEGEE ACTUATOR.

E-3 = OPEN ACTUATOR. VERIFY THAT 30/PUR AND 31/YEL ARE NOT OPEN, THEN REPLACE THE SQUEEGEE ACTUATOR.

E-13 = OPEN FUSE 1 ON CONTROL BOARD. SQUEEGEE ACTUATOR IS DRAWING EXCESSIVE CURRENT, OR THE CONTROL BOARD OUTPUT IS BAD. GO TO MANUAL MODE, THEN PUT IN A NEW FUSE. LOWER THE SQUEEGEE. REPLACE THE ACTUATOR IF THE FUSE BLOWS AGAIN. IF IT STILL BLOWS A FUSE, REPLACE THE CONTROL BOARD.

NOTE: FUSE 1 AND FUSE 2 ARE LOCATED ON THE SCRUBBING CIRCUIT BOARD. THE CIRCUIT BOARD IS LOCATED IN THE SMALL CONTROL PANEL AT THE LEFT OF THE STEERING COLUMN

NOTE: FUSE 3 IS LOCATED ON THE SWEEPING CIRCUIT BOARD. THE CIRCUIT BOARD IS LOCATED IN THE SMALL CONTROL PANEL AT THE LEFT OF THE STEERING COLUMN

E16 = P4-6 SHUNT SIGNAL IS LOW = LOW CURRENT SENSED FROM RIGHT BRUSH MOTOR SHUNT. VERIFY BRUSH MOTOR IS ON, AND AMPERAGE IS WITHIN SPECIFICATIONS, AND SHUNT IS HOOKED UP PROPERLY. THEN REPLACE THE SHUNT.

E17 = P4-6 SHUNT SIGNAL IS HIGH = EXCESSIVE CURRENT SENSED FROM RIGHT BRUSH MOTOR SHUNT. VERIFY BRUSH MOTOR IS SPINNING FREELY, AND AMPERAGE IS WITHIN SPECIFICATIONS, AND SHUNT IS HOOKED UP PROPERLY.
(KEYSWITCH OFF) DISCONNECT P4 FROM THE CONTROL BOARD, AND CHECK CONTINUITY BETWEEN (P4-6 AND P4-5) AND (P4-3 AND P4-2). IF AN OPEN EXISTS: SHUNT WIRES OR SHUNT ARE OPEN. IF CONTINUITY EXISTS: REPLACE THE SHUNT, THEN REPLACE THE CONTROL BOARD.

E18 = P4-3 SHUNT SIGNAL IS LOW = LOW CURRENT SENSED FROM LEFT (OR LEFT AND CENTER) BRUSH MOTOR SHUNT. VERIFY BRUSH MOTOR(S) IS ON, AND AMPERAGE IS WITHIN SPECIFICATIONS, AND SHUNT IS HOOKED UP PROPERLY. THEN REPLACE THE SHUNT.

E19 = P4-3 SHUNT SIGNAL IS EXCESSIVE = EXCESSIVE CURRENT SENSED FROM LEFT (OR LEFT AND CENTER) BRUSH MOTOR SHUNT. VERIFY BRUSH MOTOR(S) IS SPINNING FREELY, AND AMPERAGE IS WITHIN SPECIFICATIONS, AND SHUNT IS HOOKED UP PROPERLY.
(KEYSWITCH OFF) DISCONNECT P4 FROM THE CONTROL BOARD, AND CHECK CONTINUITY BETWEEN (P4-6 AND P4-5) AND (P4-3 AND P4-2). IF AN OPEN EXISTS: SHUNT WIRES OR SHUNT ARE OPEN. IF CONTINUITY EXISTS: REPLACE THE SHUNT, THEN REPLACE THE CONTROL BOARD.

NOTE: THE SHUNT SIGNAL, REPRESENTING BRUSH MOTOR CURRENT, BEING READ BY THE CONTROL BOARD, CAN BE MONITORED IN "CURRENT DISPLAY" DIAGNOSTIC MODE.

SQUEEGEE TESTING:

OPERATION: To lower the squeegee, the following conditions must occur:

Squeegee/Vacuum system must be selected on the touchpanel. (associated LED will be on.)

Machine in neutral or forward position.

No “low battery condition” sensed.

No “full recovery condition” sensed.

SQUEEGEE ACTUATOR EXTEND/LOWER:

30/PUR is switched to battery voltage at the control board P1-7.

31/YEL is pulsed to ground. This lowers the squeegee.

Once the squeegee actuator reaches the end of stroke, the stall current is sensed by the control board, and the output is turned off.

If no stall is sensed, the actuator will lower for a set time. (approx. 5-8 seconds.)

SQUEEGEE ACTUATOR RETRACT/LIFT:

31/YEL is switched to battery voltage at the control board P1-7.

30/PUR is pulsed to ground. This lowers the squeegee.

Once the squeegee actuator reaches the end of stroke, the stall current is sensed by the control board, and the output is turned off.

If no stall is sensed, the actuator will lower for a set time. (approx. 5-8 seconds.)

Note: This testing assumes that the machine powers up and propels.

See schematic on following page.

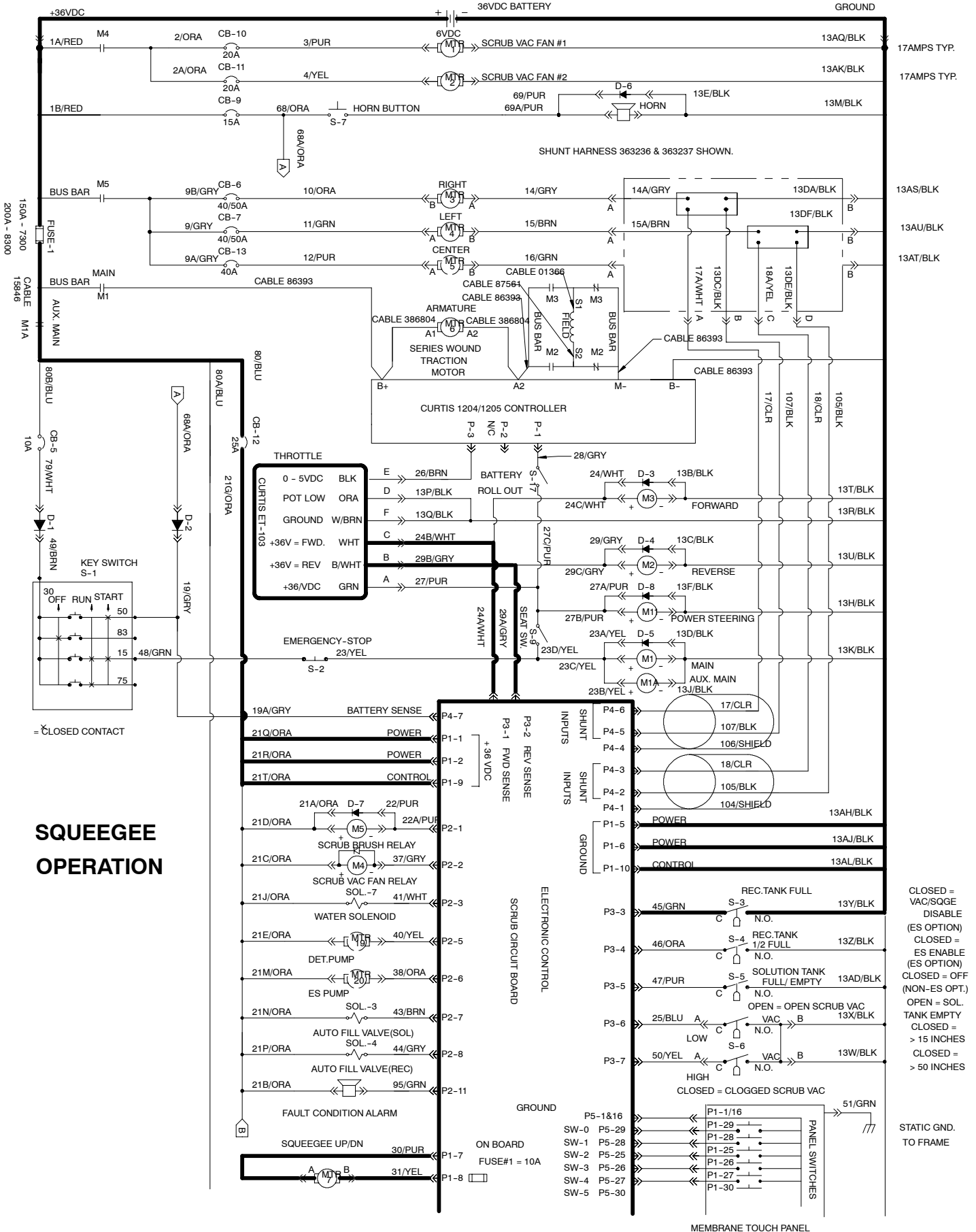

SQUEEGEE OPERATION

NOTE: THIS TEST ASSUMES THAT THE SCRUB SYSTEM CAN BE TURNED ON, AND WILL STAY ON. IF NOT, TROUBLE SHOOT THE SCRUB SYSTEM FIRST.

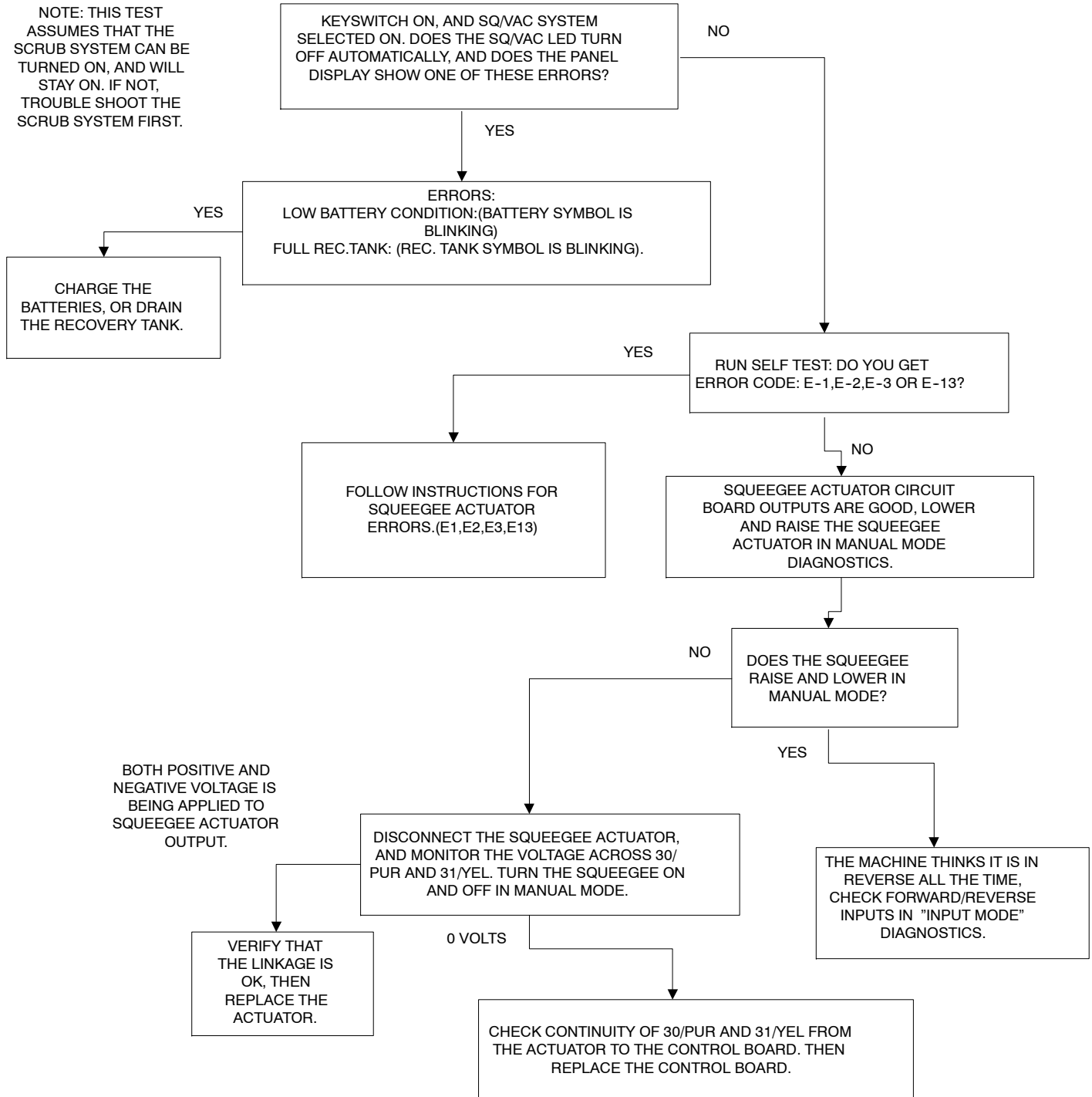

WATER VALVE TESTING:

DESCRIPTION: The water valve is activated whenever the scrub system is operating, and the machine is propelling forward.

Note: a mechanically operated valve controls the flow rate once the valve is turned on.

OPERATION:

The SCRUB system is turned on, and running.

The machine is propelled forward.

41/WHT (P2-3) is pulled to ground by the control board, turning on the water valve (sol.-7)

Note: A mechanically operated valve controls the flow rate once the valve is turned on.

Note: This testing assumes that the machine powers up and propels.

See schematic on following page.

WATER VALVE TESTING

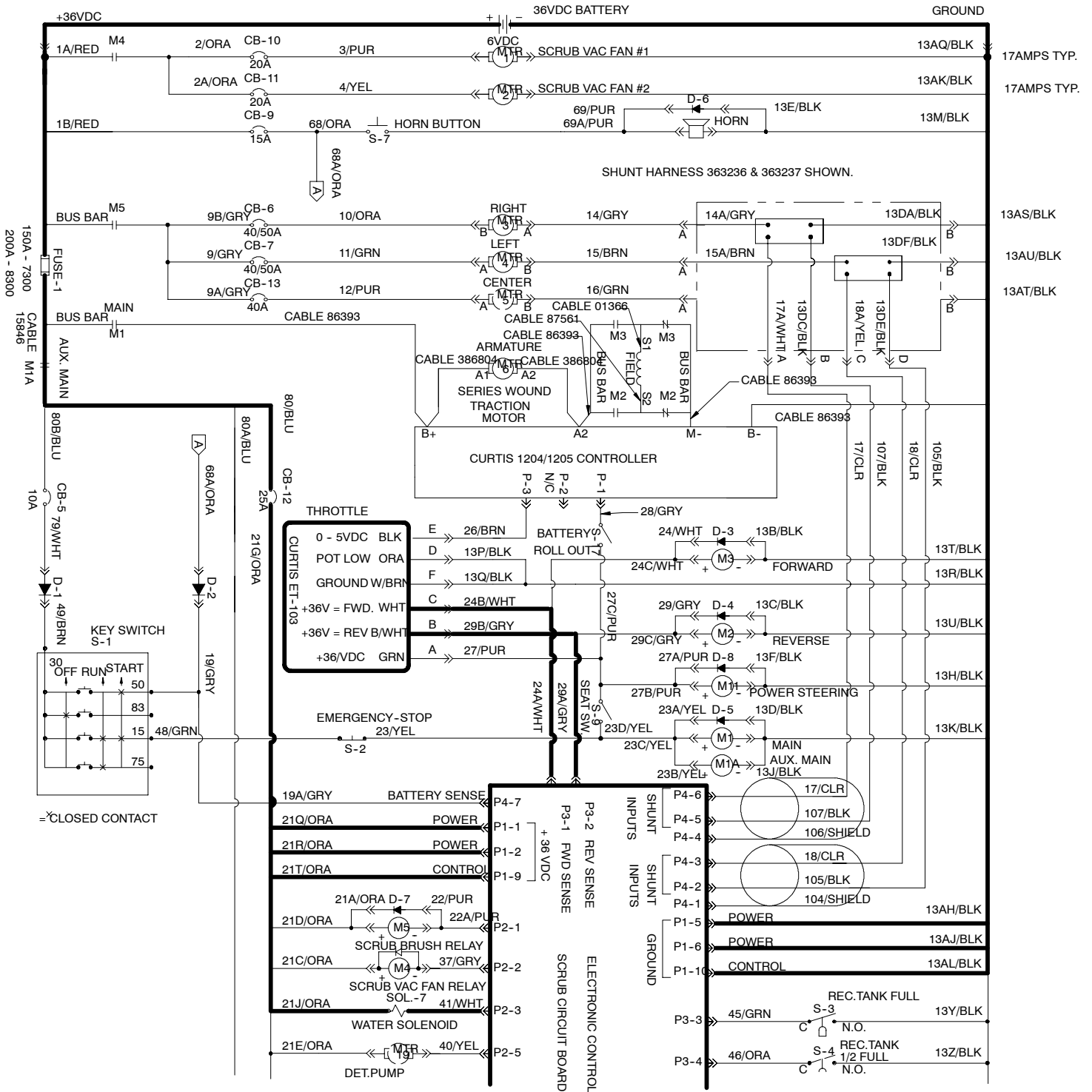

WATER VALVE TESTING

MACHINE POWERS UP
AND PROPELS.

NOTE: THIS TEST ASSUMES THAT THE SCRUB SYSTEM CAN BE TURNED ON, AND WILL STAY ON. IF NOT, TROUBLE SHOOT THE SCRUB SYSTEM FIRST.

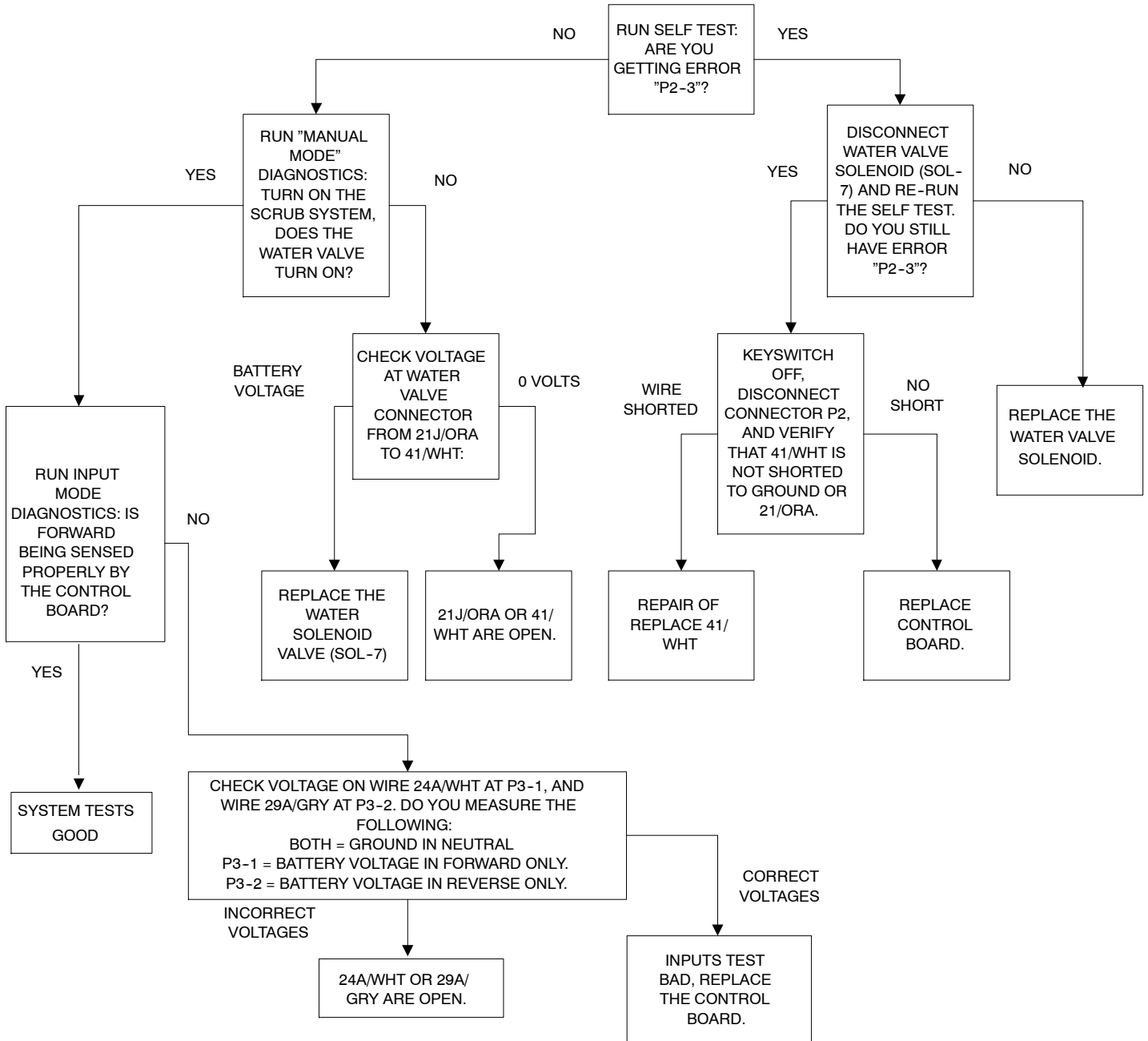

OPEN/CLOGGED SCRUB VAC SWITCH TESTING:

DESCRIPTION: With scrub system active: If the scrub vacuum pressure drops below 15 inches, the low side of S-6 opens, and an open vac icon appears on the touchpanel. If the scrub vacuum pressure exceeds 50 inches, the high side of S-6 closes, and a clogged vac icon appears.

OPERATION:

Scrub system is activated and running.

Under normal operating conditions the scrub vacuum pressure is between 15 and 50 inches, and the low side of S-6 is closed, and the high side of S-6 is open.

If vacuum pressure drops below 15 inches (open vac condition) the low side of S-6 opens, and an open vacuum icon is shown on the touchpanel display.

If vacuum pressure exceeds 50 inches (clogged vac condition) the high side of S-6 closes, and a clogged vacuum icon is shown on the touchpanel display.

Displays warning icons only - No flow chart needed

See schematic on following page.

OPEN/CLOGGED SCRUB VAC SWITCH TESTING

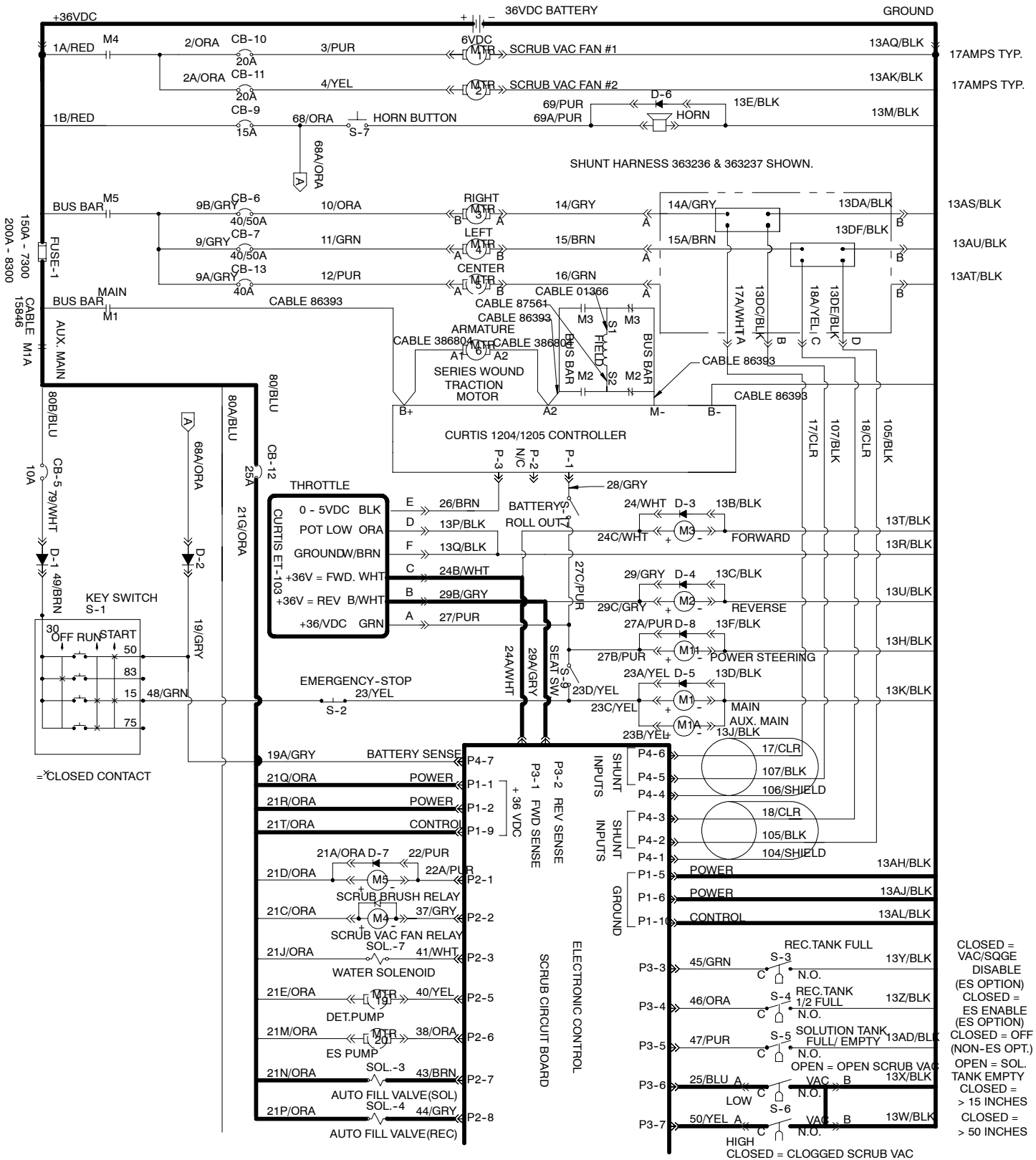

ELECTRICAL

ES™ SYSTEM OPERATION AND TESTING:

DESCRIPTION: The ES™ system pumps used water from the recovery tank, through a filter, and into the solution tank.

OPERATION:

The ES™ system is selected on the touch panel.

The recover tank full float is activated.

The ES™ pump is turned on until a or b:

- The recovery tank float is deactivated for 30 seconds.
- The solution tank full float is activated.
- ES™ system is selected off at the touchpanel.

Note: This testing assumes that the machine powers up and propels.

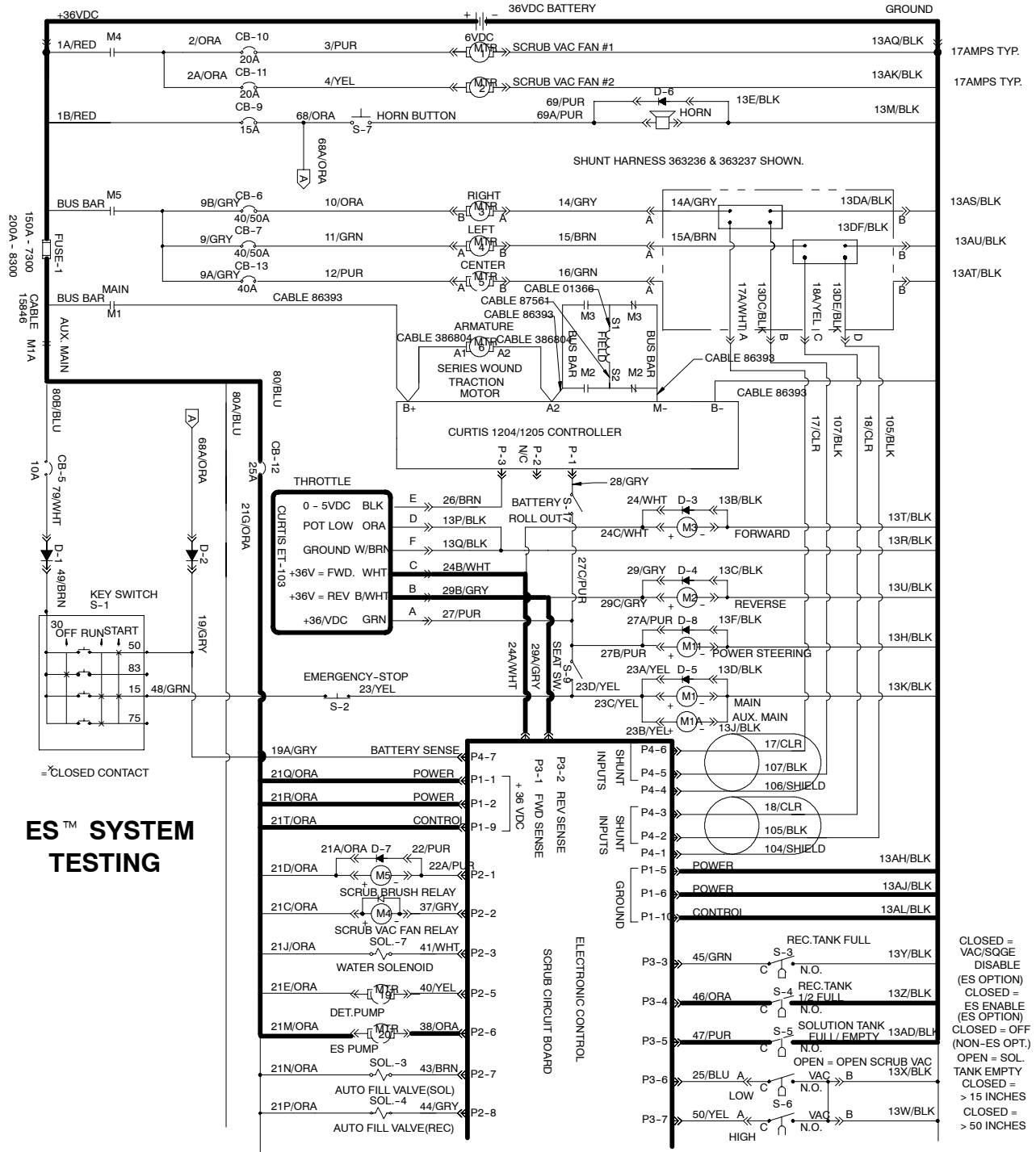

ES™ SYSTEM TESTING

MACHINE POWERS UP AND PROPELS.

NOTE: THIS TEST ASSUMES THAT THE SCRUB SYSTEM CAN BE TURNED ON, AND WILL STAY ON. IF NOT, TROUBLE SHOOT THE SCRUB SYSTEM FIRST.

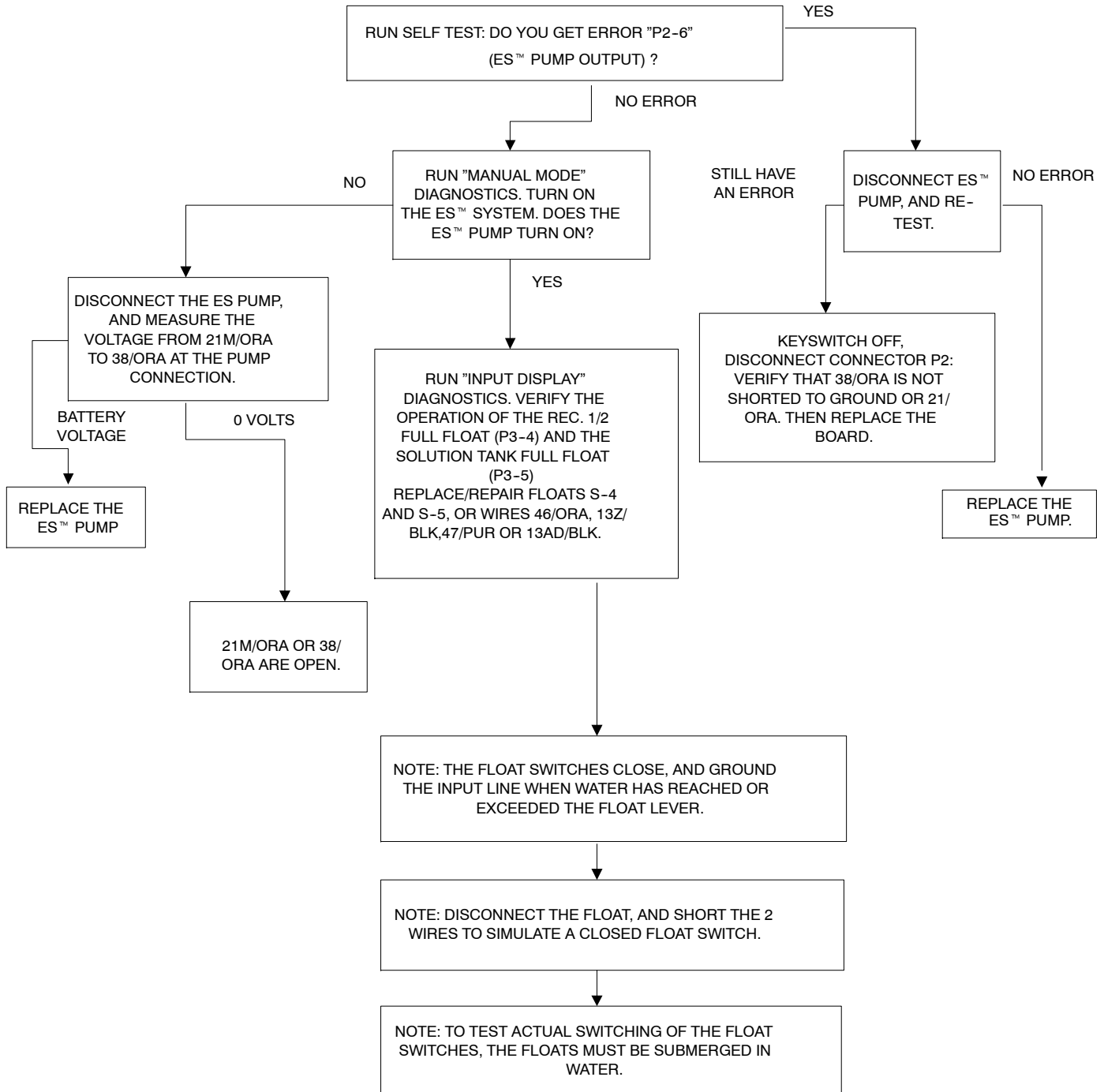

DETERGENT METERING SYSTEM TESTING:

DESCRIPTION: The detergent metering pump is activated whenever the scrub system is operating, the machine is propelling forward, and the detergent metering system is selected on. The pump runs at low and high speed.

OPERATION:

The SCRUB system is turned on, and running.

The machine is propelled forward.

The detergent metering system is selected on. (low or high speed)

40/YEL (P2-5) is pulsed to ground by the control board, turning on the detergent pump.

Note: Low speed = 35% duty cycle = about 12.5VDC at the pump.

Note: High speed = 62.5% duty cycle = about 22.5VDC at the pump.

See schematic on following page.

DETERGENT METERING TESTING

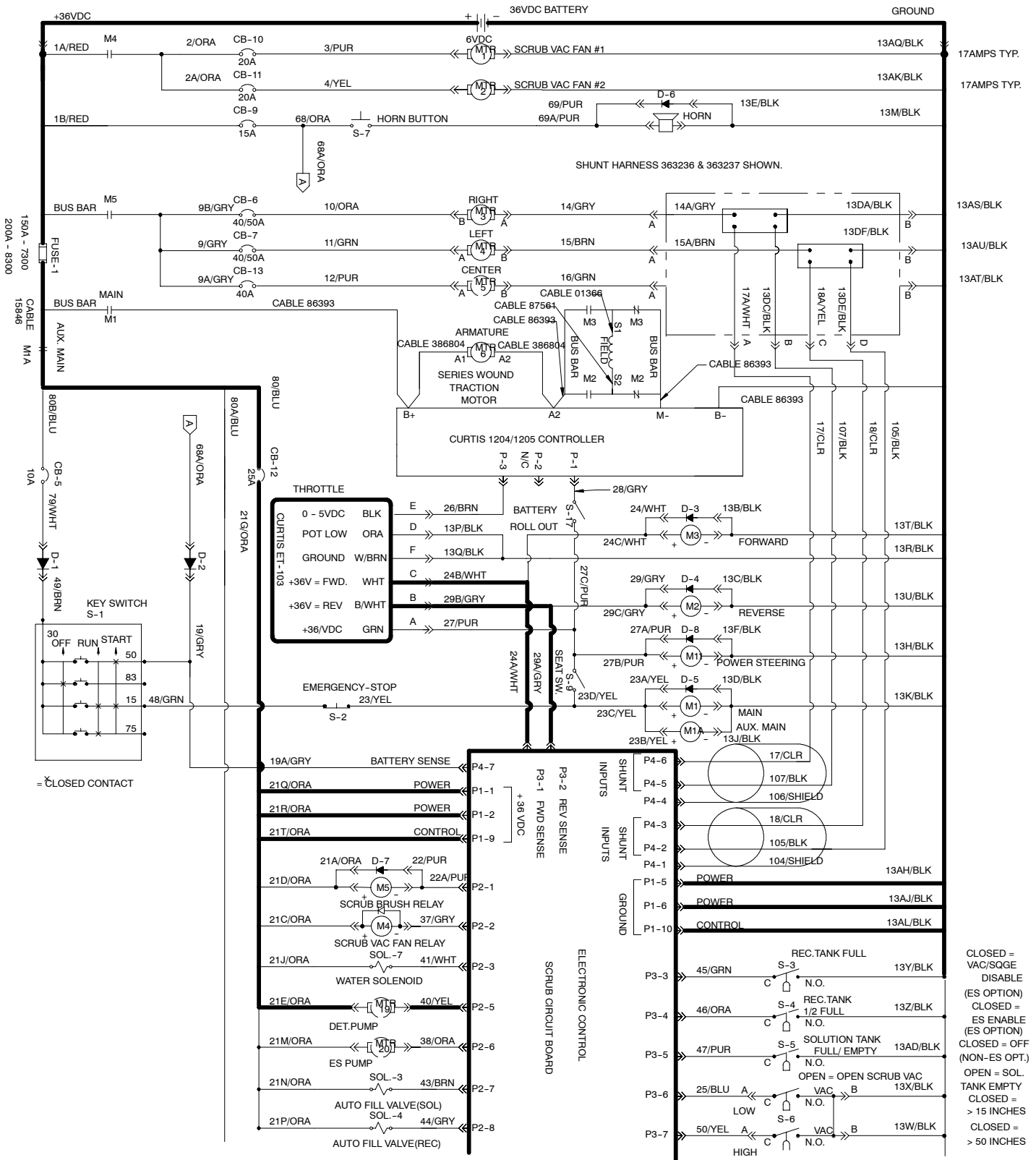

DETERGENT METERING TESTING

MACHINE POWERS UP AND PROPELS.

NOTE: THIS TEST ASSUMES THAT THE SCRUB SYSTEM CAN BE TURNED ON, AND WILL STAY ON. IF NOT, TROUBLE SHOOT THE SCRUB SYSTEM FIRST.

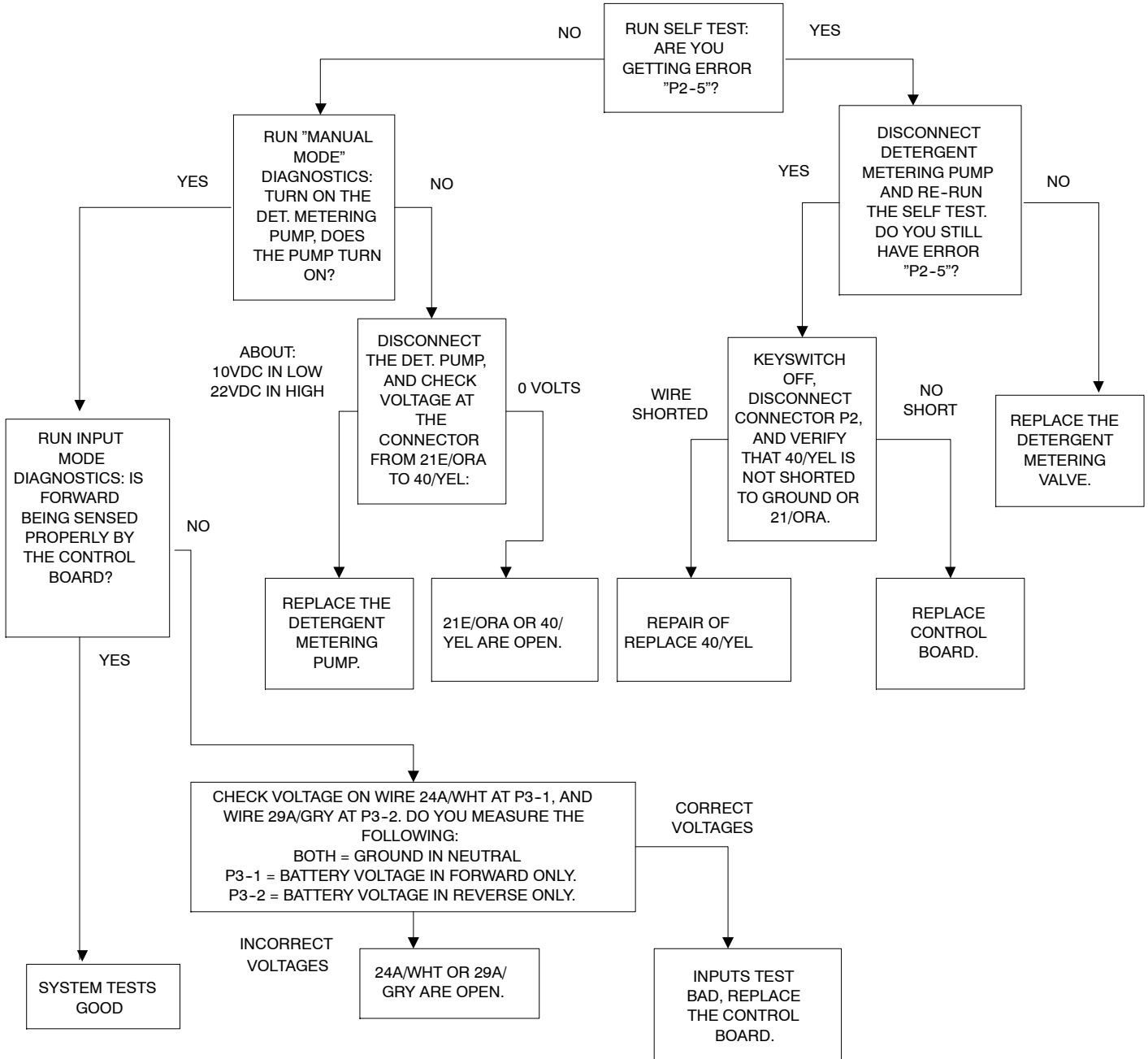

AUTO FILL SYSTEM TESTING:

DESCRIPTION: With keyswitch on, propel in neutral: the solution auto fill valve will open until the solution full float closes. The recovery auto fill valve will open until the recovery $\frac{1}{2}$ full float closes.

OPERATION:

- 1) Turn the keyswitch on, and leave the machine in neutral.
- 2) Hook water line up to outside valve, and turn on.
- 3) 43/BRN is pulled to ground at pin P2-7, turning on the solution auto fill valve (sol-3). This valve stays on until the solution full float (s-5) closes.
- 4) 44/GRY is pulled to ground at pin P2-8, turning on the recovery auto fill valve (sol-4). This valve stays on until the recovery $\frac{1}{2}$ full float (s-4) closes.

See schematic on following page.

AUTO FILL TESTING

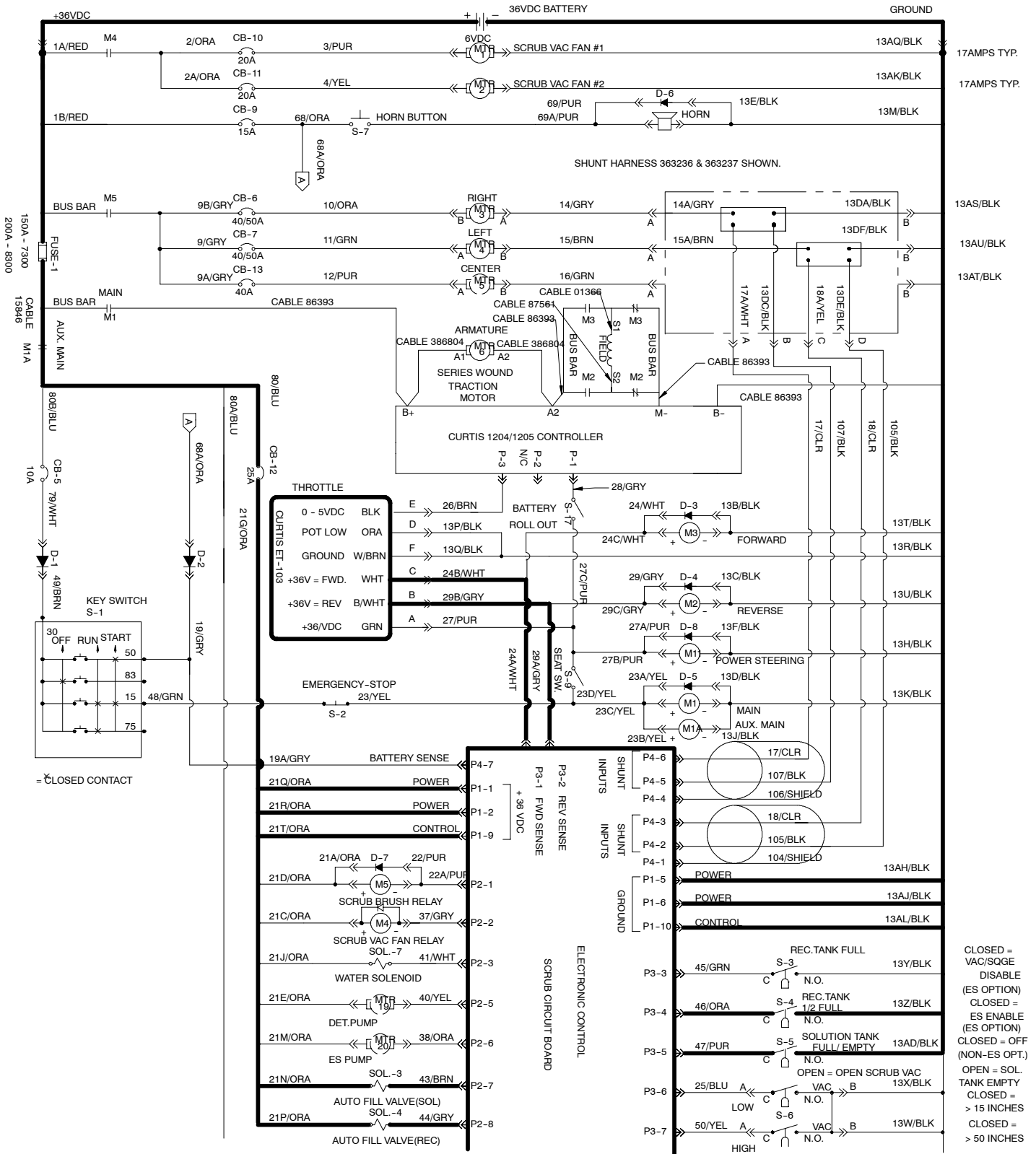

AUTO FILL TESTING

MACHINE POWERS UP
AND PROPELS.

NOTE: THIS TEST ASSUMES THAT THE SCRUB SYSTEM CAN BE TURNED ON, AND WILL STAY ON. IF NOT, TROUBLE SHOOT THE SCRUB SYSTEM FIRST.

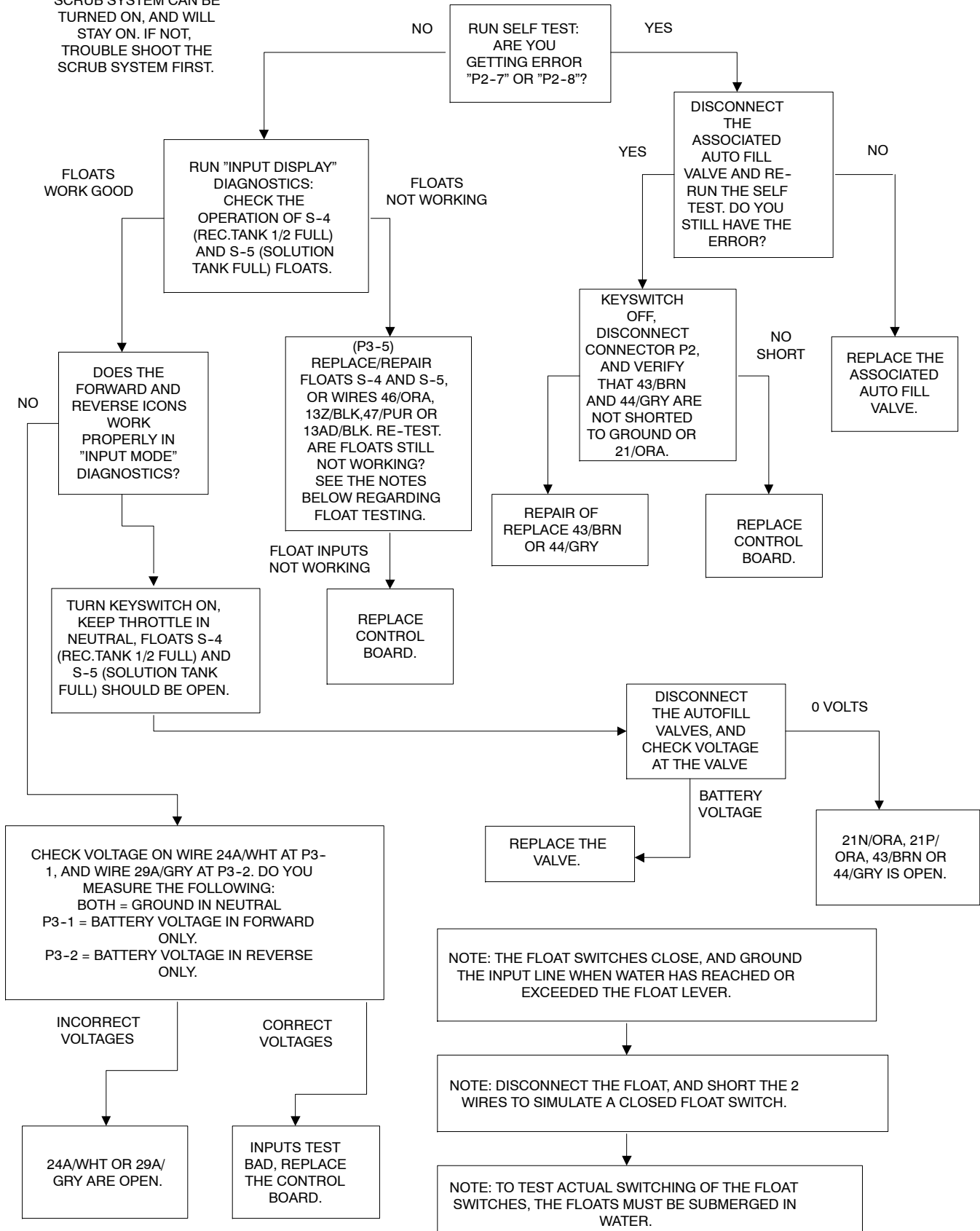

POWER STEERING TESTING

MACHINE POWERS UP AND PROPELS.

NOTE: THIS TEST ASSUMES THAT THE MACHINE POWERS UP, AND PROPELS.

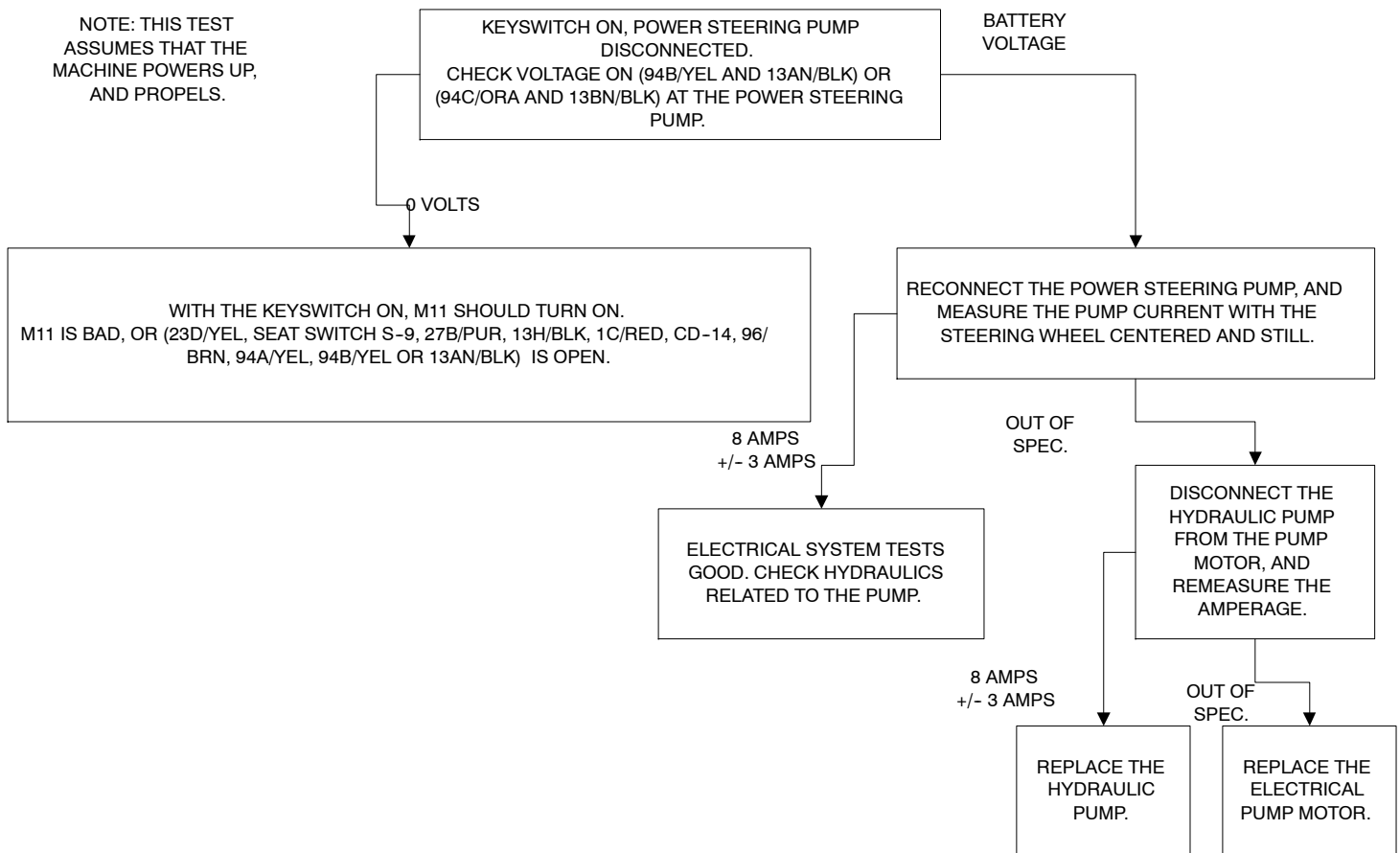

SWEEP BRUSH SYSTEM TESTING:

- 1) Sweep system is selected on the touchpanel, the associated LED will turn on.
- 2) When forward propel is sensed, the sweep brush turns on and is lowered.
- 3) The control board pulls 75/BRN to ground at P2-8, turning on M7 contactor (sweep brush).
- 4) M7 contactor closes, supplying power to the sweep brush motor through CB-3. The sweep brush motors turn on.

SWEEPER HEAD LOWER/RAISE ACTUATOR:

- 1) 53/PUR is switched to battery voltage at the control board P2-7.
- 2) 54/YEL is pulsed to ground. This lowers the sweeper head.
- 3) Once the sweeper head actuator reaches the end of stroke, the stall current is sensed by the control board, and the output is turned off.
- 4) If no stall is sensed, the actuator will lower for a set time. (approx. 5-8 seconds.)

SYSTEM INHIBITS:

- 1) Neutral or reverse will turn off the sweep brush/vac and lift the sweeper head after a delay.
- 2) When the hopper is lifted (lift switch opens).
- 3) Low battery will automatically turn off the scrub system, and flash the battery icon.
- 4) Hopper Thermal Sentry system senses a hopper fire (Thermal sentry switch closes).

Note: This testing assumes that the machine powers up and propels.

SWEEP BRUSH TESTING

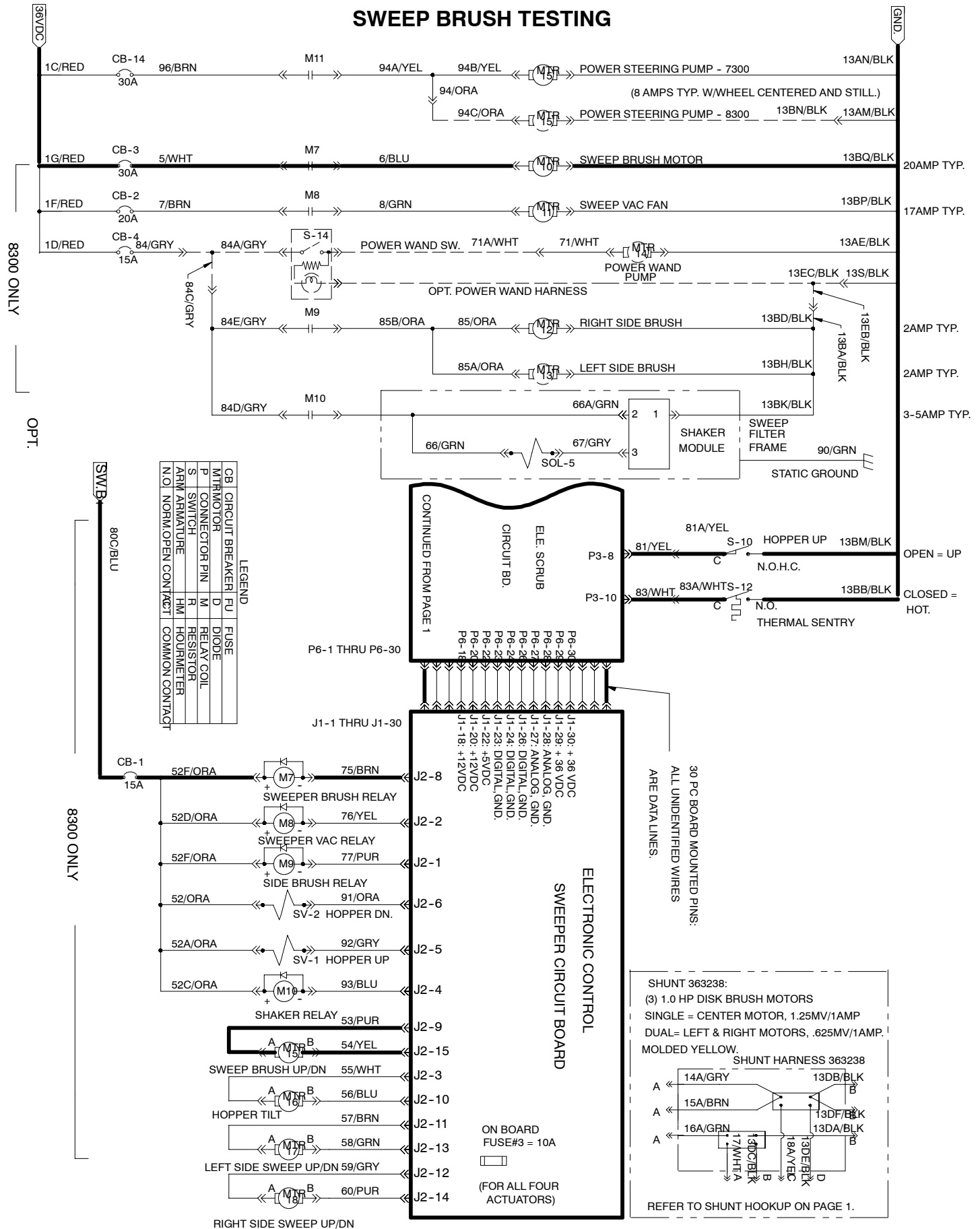

SWEEP BRUSH SYSTEM TESTING

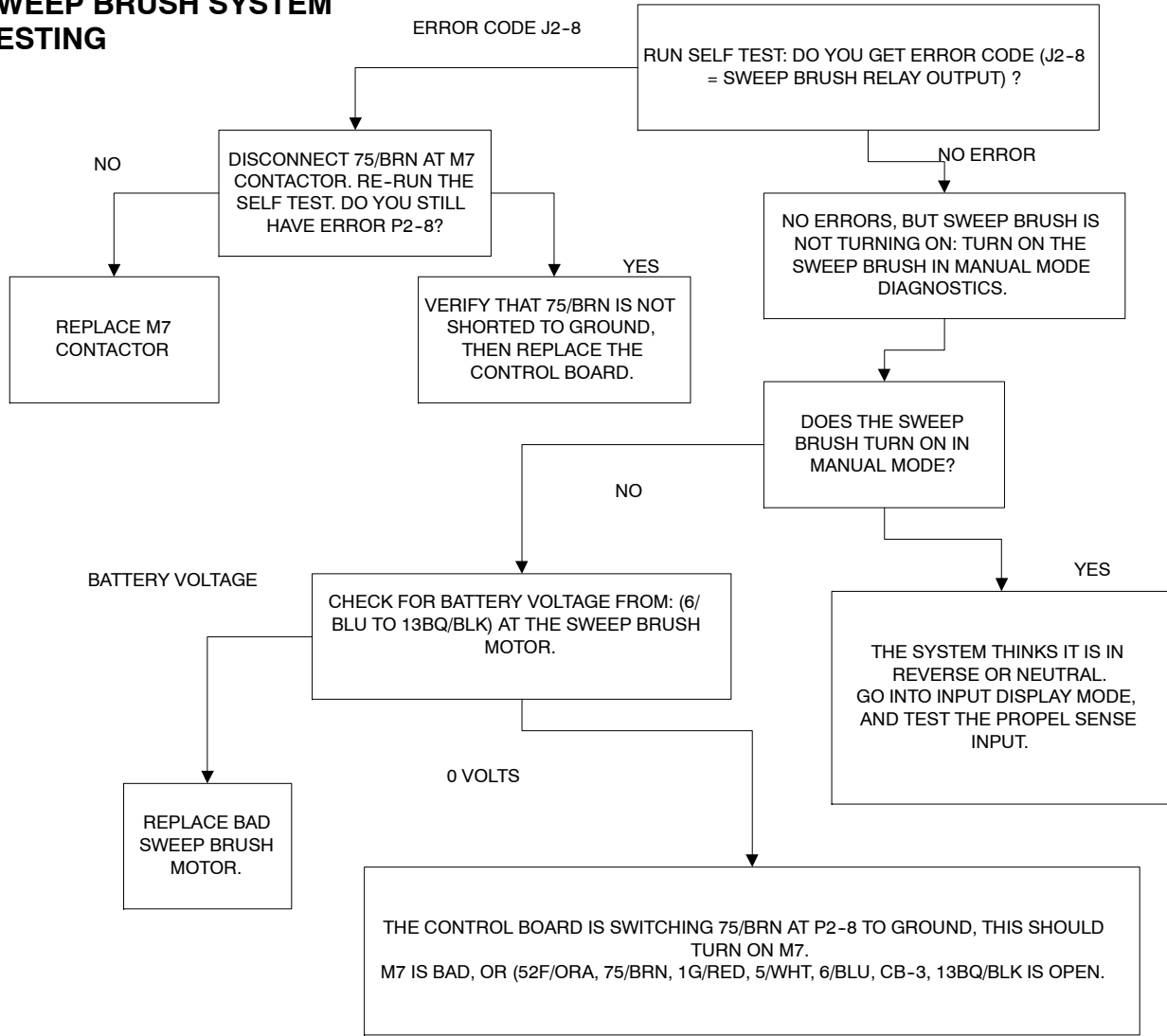

E-10 = THE CIRCUIT BOARD IS SENSING SWEEP ACTUATOR CURRENT WITH THE ACTUATOR TURNED OFF. REPLACE THE CONTROL BOARD.

E-11 = STALLED OR JAMMED ACTUATOR. VERIFY THAT 53/PUR AND 54/YEL ARE NOT SHORTED TOGETHER, THEN REPLACE THE SWEEPER UP/DN ACTUATOR.

E-12 = OPEN ACTUATOR. VERIFY THAT 53/PUR AND 54/YEL ARE NOT OPEN, THEN REPLACE THE SWEEPER UP/DN ACTUATOR.

E-15 = OPEN FUSE 3 ON CONTROL BOARD. SWEEPER ACTUATOR IS DRAWING EXCESSIVE CURRENT, OR THE CONTROL BOARD OUTPUT IS BAD. GO TO MANUAL MODE, THEN PUT IN A NEW FUSE. LOWER THE SWEEPER HEAD. REPLACE THE ACTUATOR IF THE FUSE BLOWS AGAIN. IF IT STILL BLOWS A FUSE, REPLACE THE CONTROL BOARD.

SWEEPER VACUUM ACTIVATION:

- 1) Sweep system is selected on the touchpanel, the associated LED will turn on.
- 2) When forward propel is sensed, the sweep system (including sweep vac) turns on.
- 3) The control board pulls 76/YEL to ground at P2-2, turning on M8 contactor (sweep vacuum).
- 4) M8 contactor closes, supplying power to the sweep vacuum motor through CB-2. The sweep vacuum motor turns on.

SWEEP SYSTEM INHIBITS:

- 1) Neutral or reverse will turn off the sweep system (including sweep vac.) after a delay.
- 2) When the hopper is lifted (lift switch opens), the sweep system (including sweep vac) is turned off.
- 3) Low battery will automatically turn off the sweep system (including sweep vac) , and flash the battery icon.
- 4) Hopper Thermal Sentry system senses a hopper fire (Thermal sentry switch closes), and turns off the sweeper system (including sweeper vac), and displays a hopper with thermostat icon.

Note: This testing assumes that the machine powers up, propels and scrubs.

SWEEP VACUUM TESTING

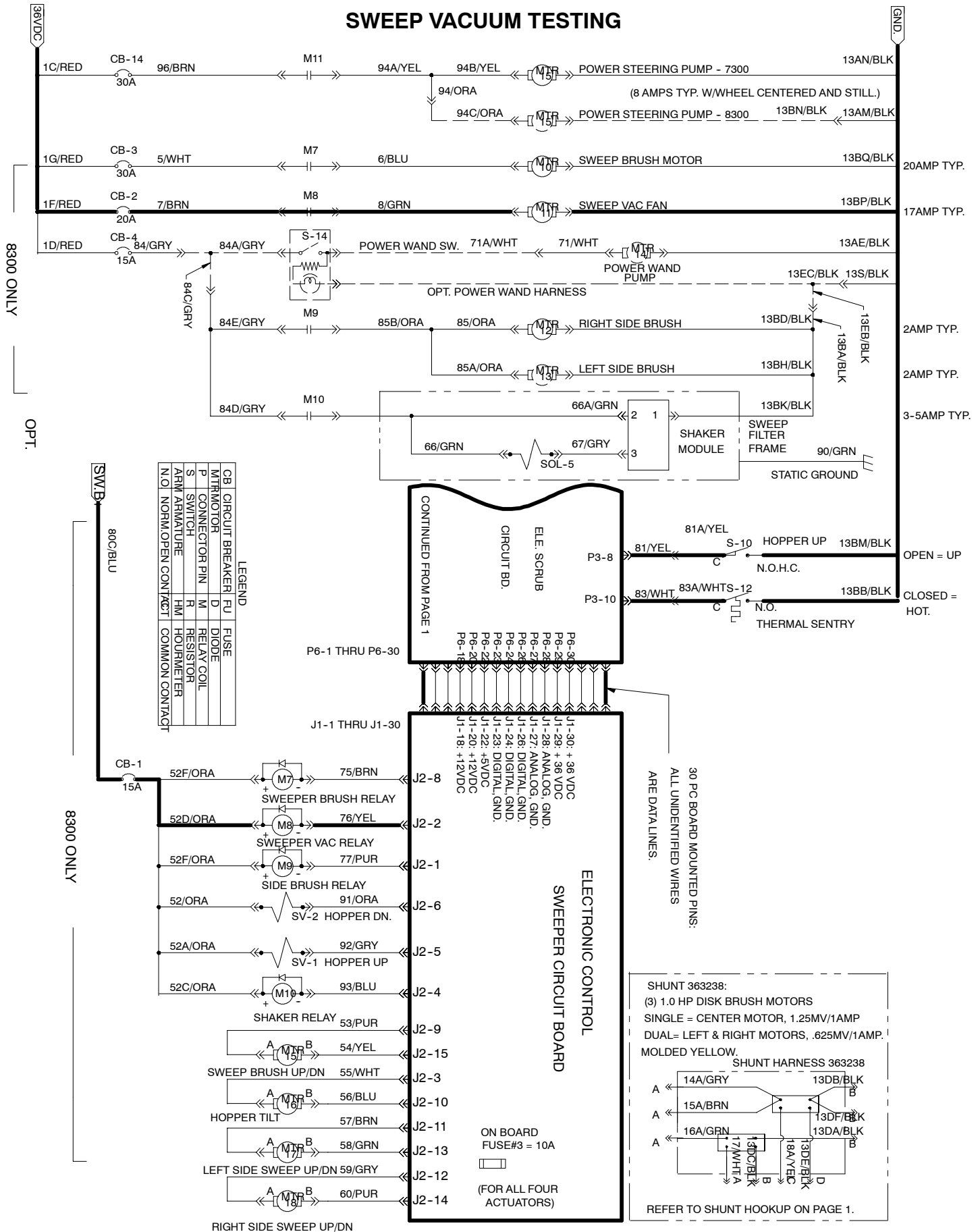

SWEEPER VACUUM ACTIVATION

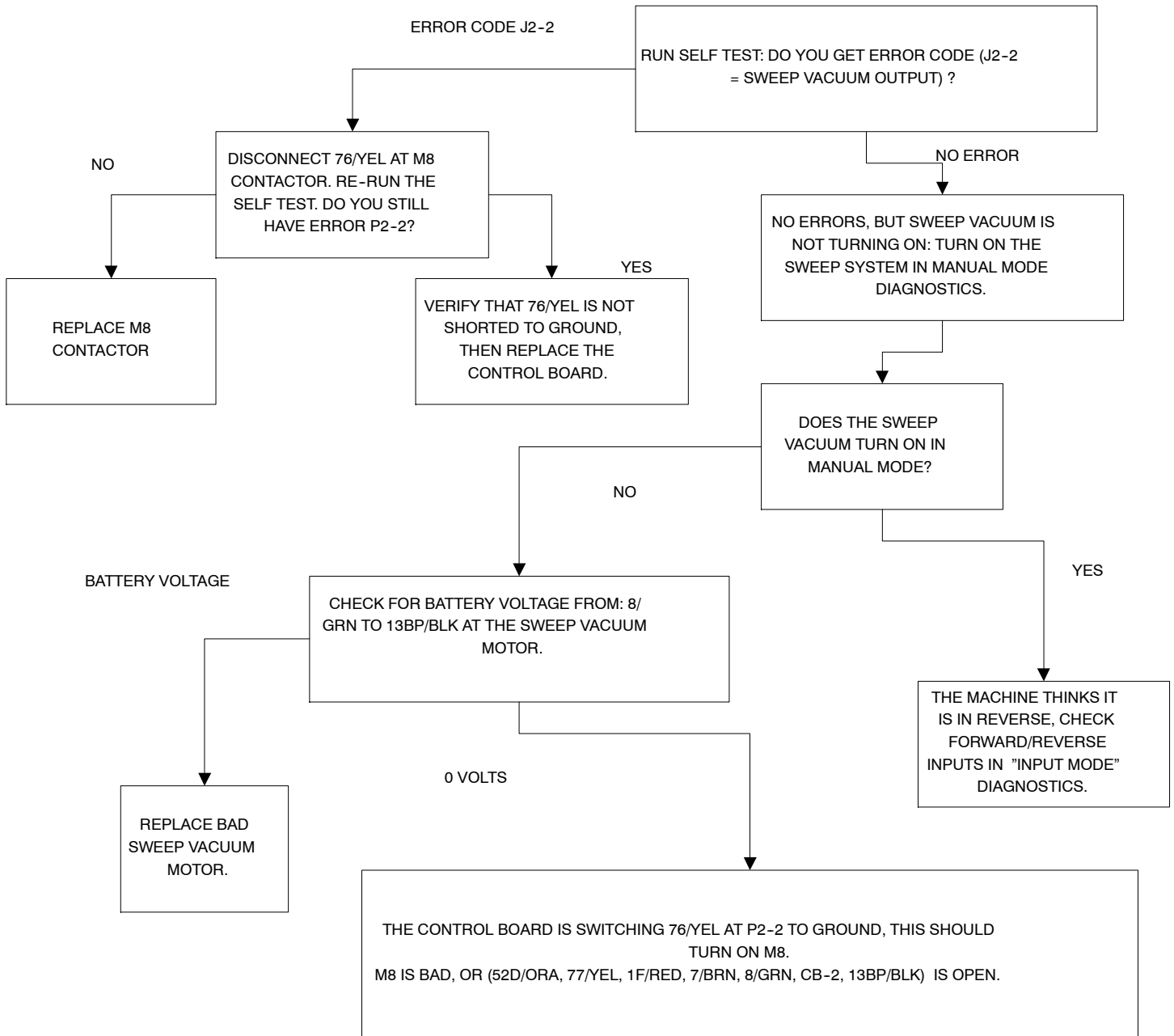

SWEEP SIDE BRUSH SYSTEM TESTING:

SWEEP SIDE BRUSH MOTORS:

- 1) Sweep side brushes are selected on as a default when the sweep system is activated.
- 2) The side brushes will be spinning whenever the machine is propelling forward.
- 3) The side brushes can be manually selected off at the touchpanel.

SWEEPER SIDE BRUSH LOWER/RAISE ACTUATORS:

- 1) Sweep side brush is selected on as a default when the sweep system is activated.
- 2) The right side brush is automatically lowered, then the left side brush is lowered.
- 3) 59/GRY is switched to battery voltage at the control board P2-10.
- 4) 60/PUR is pulsed to ground at J2-14. This lowers the right side brush.
- 5) 57/BRN is switched to battery voltage at the control board P2-11.
- 6) 58/GRN is pulsed to ground at J2-15. This lowers the left side brush.
- 7) Once the side brush actuator reaches the end of stroke, the stall current is sensed by the control board, and the output is turned off.
- 8) If no stall is sensed, the actuator will lower for a set time. (approx. 5-8 seconds.)
- 9) If the side brush system is turned off, the left side brush will lift, then the right side brush.

SYSTEM INHIBITS:

- 1) Neutral or reverse will turn off the sweep the side brushes, but the side brushes will stay down.
- 2) Low battery will automatically turn off the sweep system, and flash the battery icon.
- 3) When the hopper is lifted (lift switch opens), the sweep system is deactivated.
- 4) Hopper Thermal Sentry system senses a hopper fire (Thermal sentry switch closes), and will deactivate the sweep system.

Note: The optional left side brush must be enabled. This is one of the diagnostic menus.

Note: This testing assumes that the machine powers up, propels, scrubs and sweeps.

SWEEP SIDE BRUSH TESTING

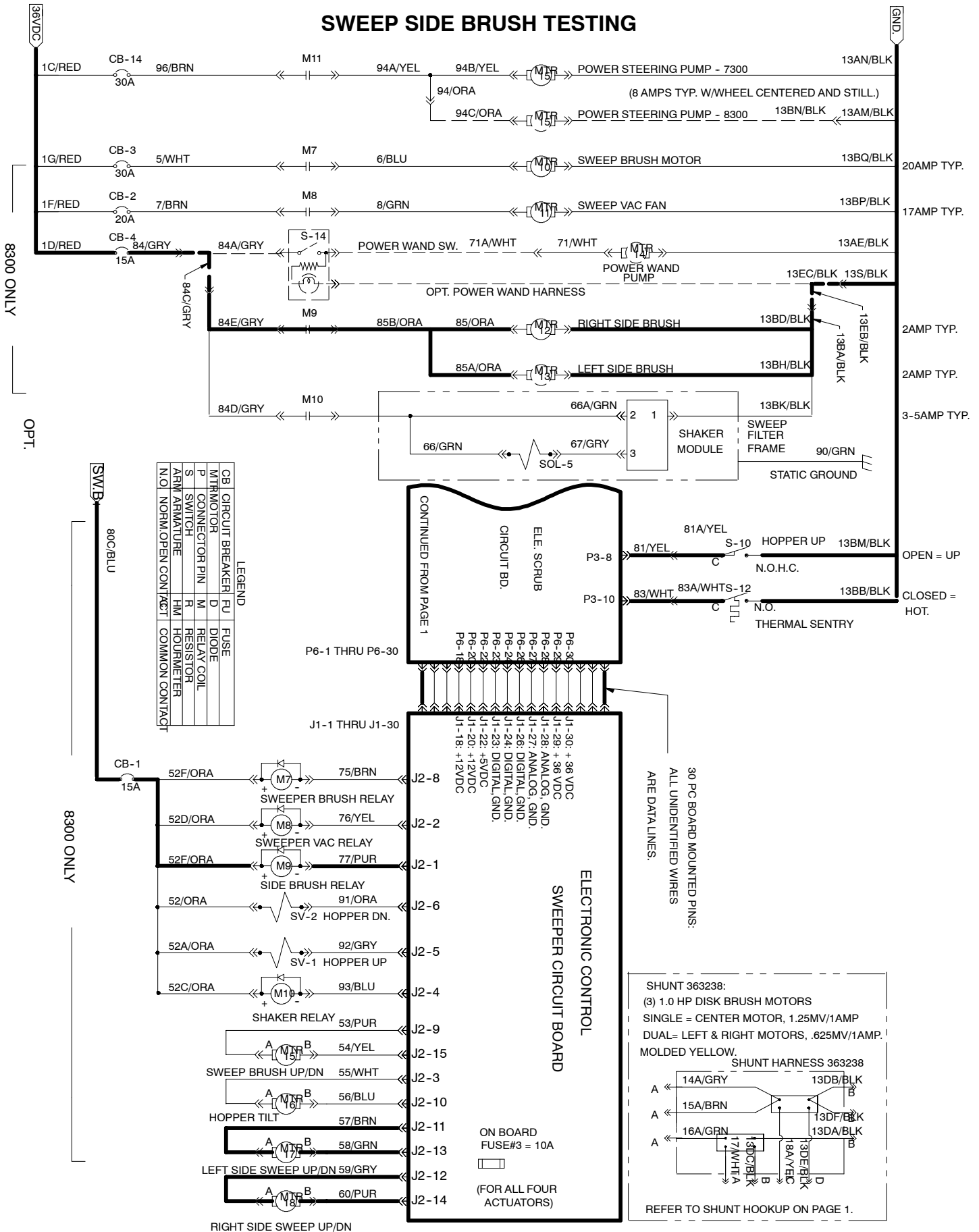

**SWEEP SIDE
BRUSH OPERATION**

NOTE: THIS TEST ASSUMES THAT THE MACHINE WILL POWER UP, PROPEL AND SWEEP. IF NOT, TROUBLE SHOOT THESE SYSTEMS FIRST.

NOTE: IF NO SWEEP SYMBOL IS DISPLAYED, GO INTO DIAGNOSTIC MODE, AND ENABLE THE SWEEP SYSTEM.

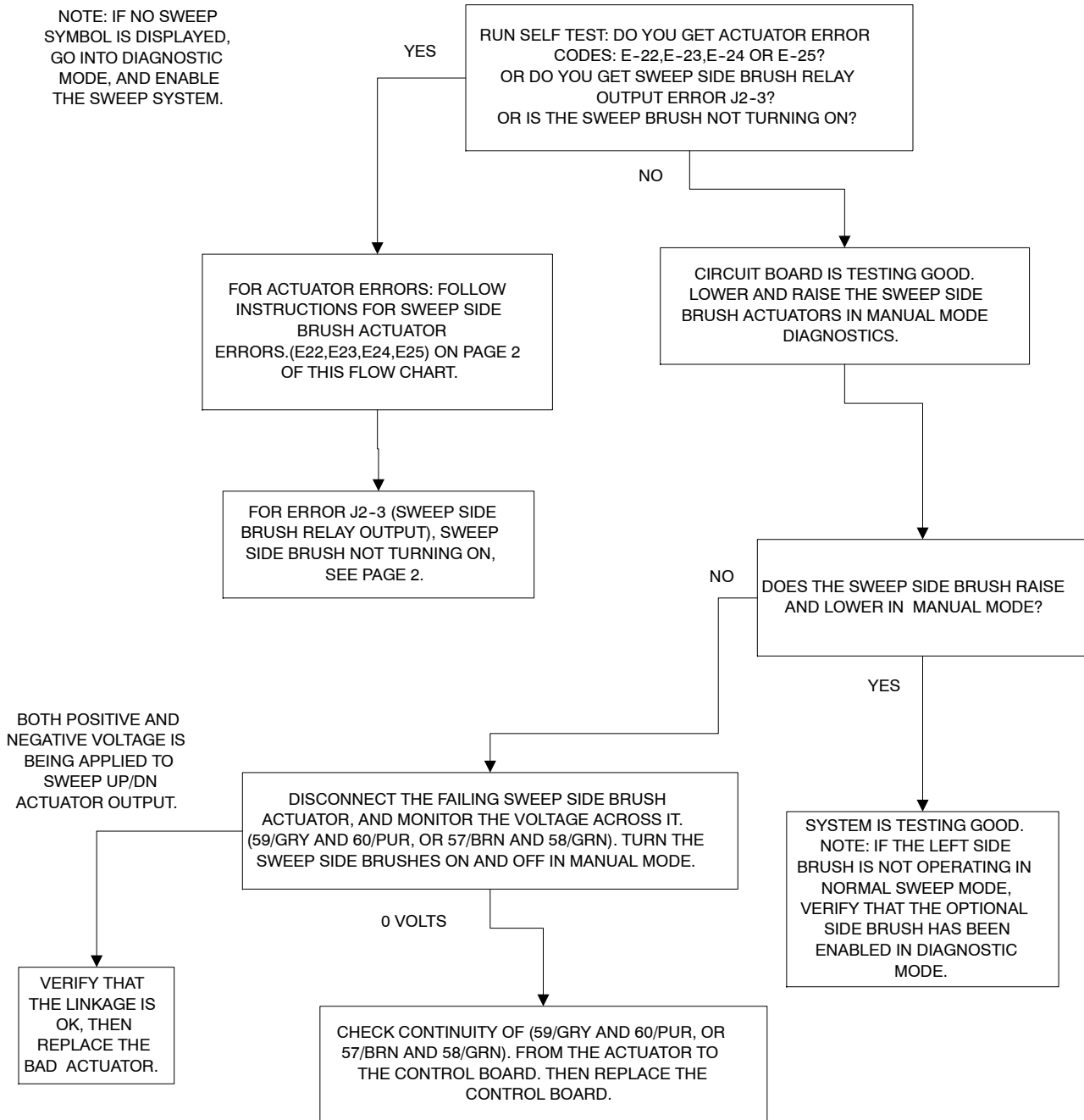

SHAKER SYSTEM TESTING:**SWEEPER VACUUM ACTIVATION:**

- 1) Shaker system is selected on the touchpanel, the associated LED will turn on.
- 2) The control board pulls 93/BLU to ground at P2-4, turning on M10 contactor (shaker system).
Note: M10 will automatically turn off after 10 seconds.
- 3) M10 contactor closes, supplying power to the shaker module pin 2, and the shaker solenoid SOL-5.
- 4) The shaker module will switch pin 3 (low side of shaker solenoid SOL-5) to ground and the rate of 25Hz.

- 5) This switching or pulsing will physically pull the solenoid in and out, this motion cleans the filter.

SHAKER SYSTEM INHIBITS:

- 1) If the operator turns off the shaker system the 10 second shake cycle will be cancelled.
- 2) If the hopper is lifted, the shaker system is turned off automatically.

Note: This testing assumes that the machine powers up, propels, scrubs and sweeps.

SHAKER SYSTEM TESTING

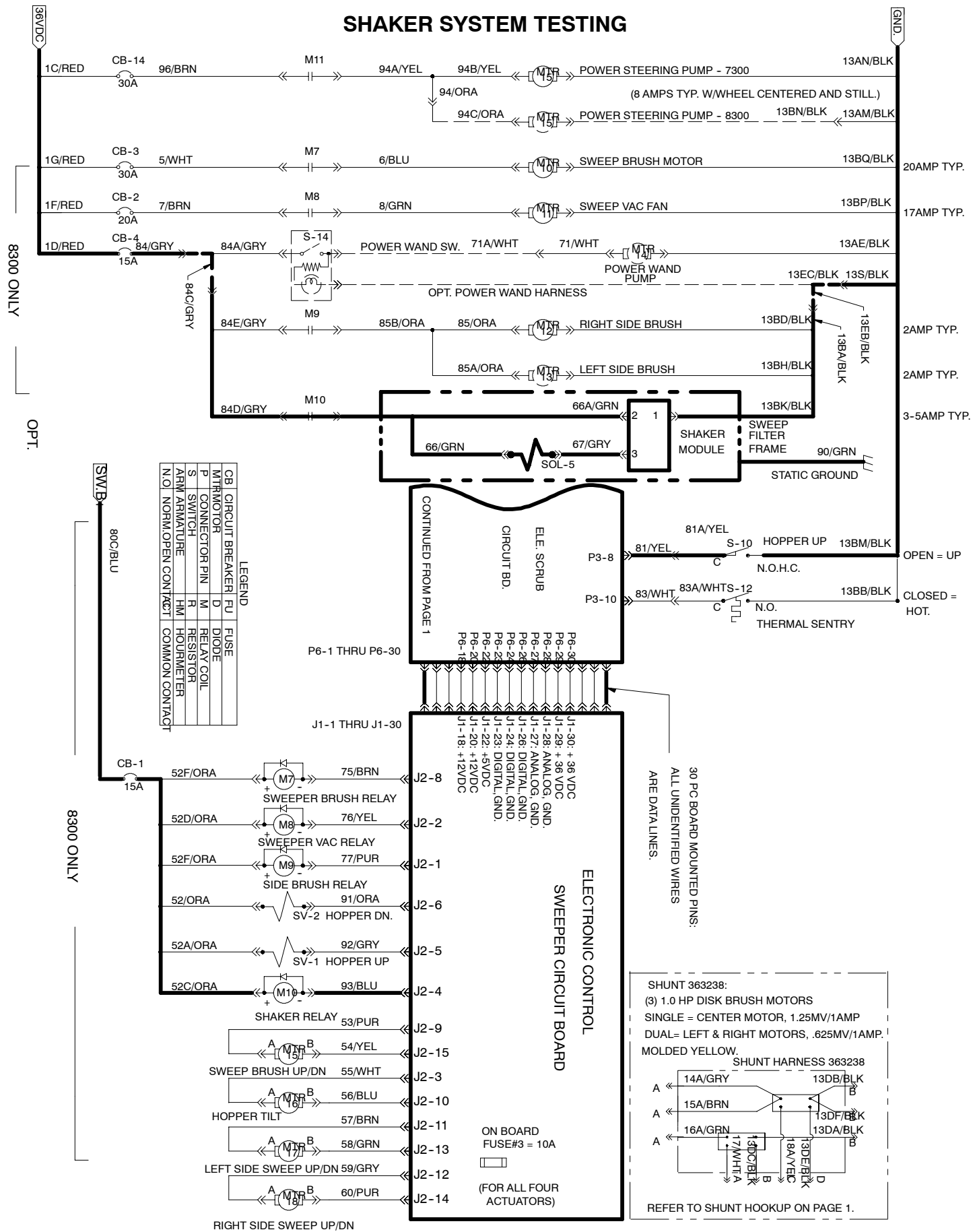

SHAKER OPERATION

NOTE: THIS TEST ASSUMES THAT THE MACHINE WILL POWER UP, PROPEL, SCRUB AND SWEEP. IF NOT, TROUBLE SHOOT THESE SYSTEMS FIRST.

NOTE: IF NO SWEEP SYMBOL IS DISPLAYED, GO INTO DIAGNOSTIC MODE, AND ENABLE THE SWEEP SYSTEM.

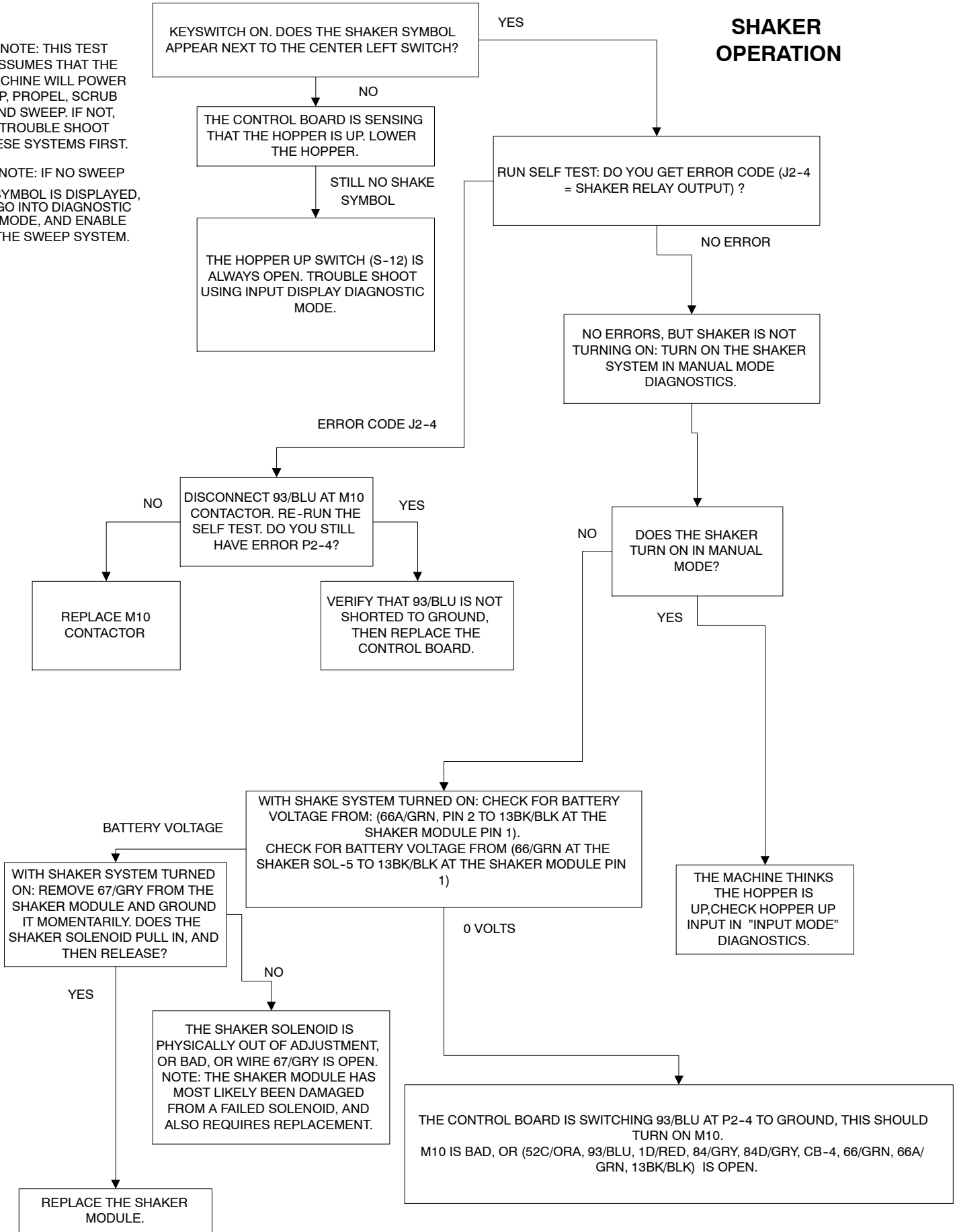

HOPPER UP/DOWN TESTING:

HOPPER LIFT/LOWER OPERATION:

Note: The hydraulic pump turns on with the keyswitch. This pump drives the power steering and hopper lift/lower operations.

- 1) Keyswitch on, hydraulic pump is turned on, operator selects hopper lift.
- 2) 92/GRY is pulled to ground at the control board J2-5.
- 3) SV-1 is activated, and the hopper lifts.
- 4) Operator selects hopper down.
- 5) 91/ORA is pulled to ground at the control board J2-6.
- 6) SV-2 is activated, and the hopper lowers.

HOPPER TILT TESTING:

HOPPER TILT DOWN/UP OPERATION:

- 1) Hopper is lifted above the minimum tilt height.
- 2) Operator activates the hopper tilt down button.
- 3) 55/WHT is switched to battery voltage at the control board J2-3.
- 4) 56/BLU is pulsed to ground at J2-10. This tilts the hopper down.
- 5) The hopper will continue to lower until the operator releases the button, or the actuator reaches the end of stroke. The stall current is sensed by the control board and the output is turned off.
- 6) Operator activates the hopper tilt up button.
- 7) 56/BLU is switched to battery voltage at the control board P2-10.
- 8) 55/WHT is pulsed to ground at J2-3. This tilts the hopper up.
- 9) The hopper will continue to lift until the operator releases the button, or the actuator reaches the end of stroke. The stall current is sensed by the control board and the output is turned off.

HOPPER TILT AND LIFT/LOWER NOTES:

- 1) When hopper is lifted from the down position, the hopper tilts down slightly first (to unseat the hopper seal properly).
- 2) The hopper will not tilt down until minimum hopper tilt height is achieved.
- 3) The hopper will automatically tilt up if the hopper is lowered below the minimum hopper tilt height.
- 4) The hopper is automatically tilted up slightly, when the hopper is lowered all the way down. This seals the hopper properly.

HOPPER UP/DOWN TESTING

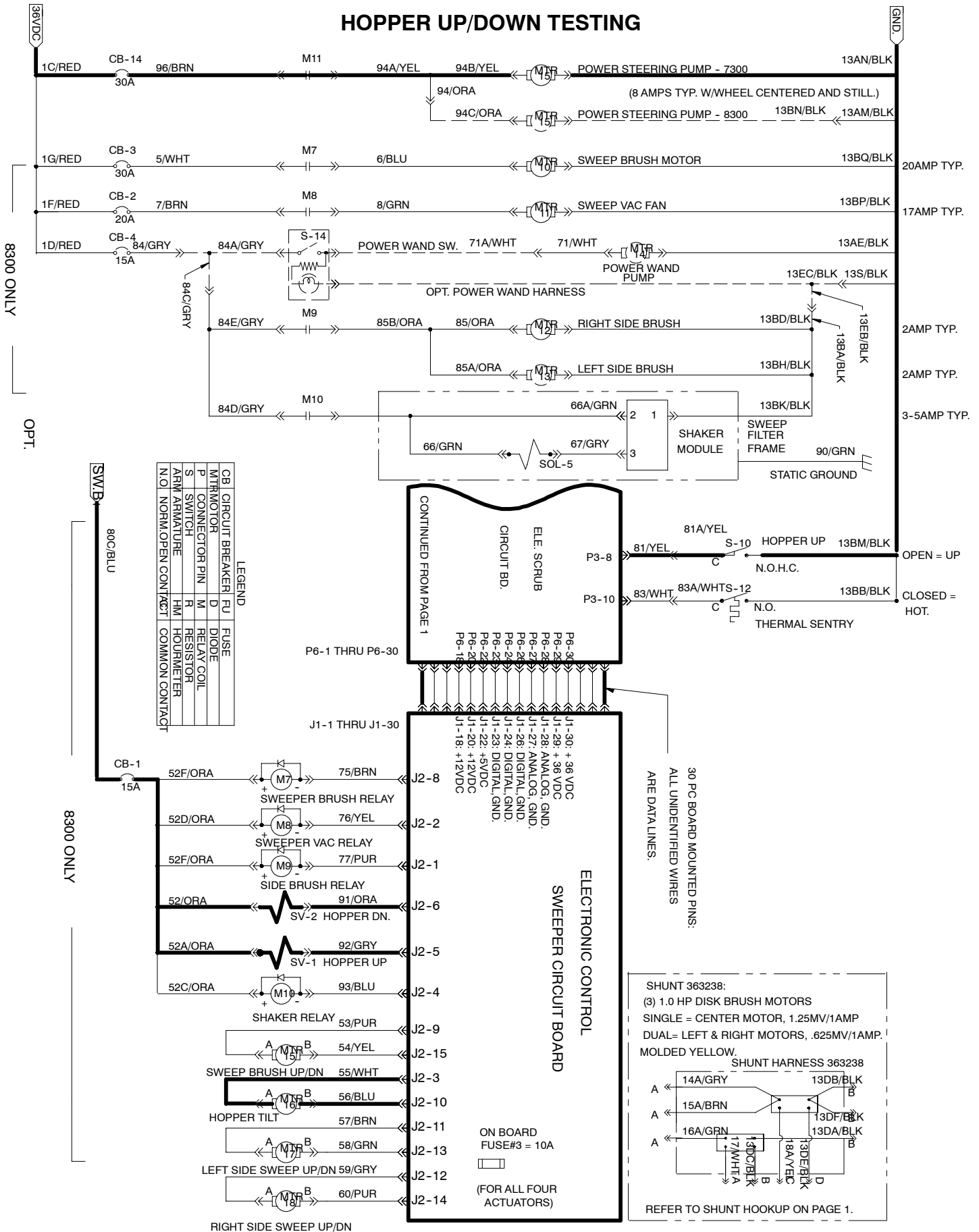

HOPPER UP/DOWN OPERATION

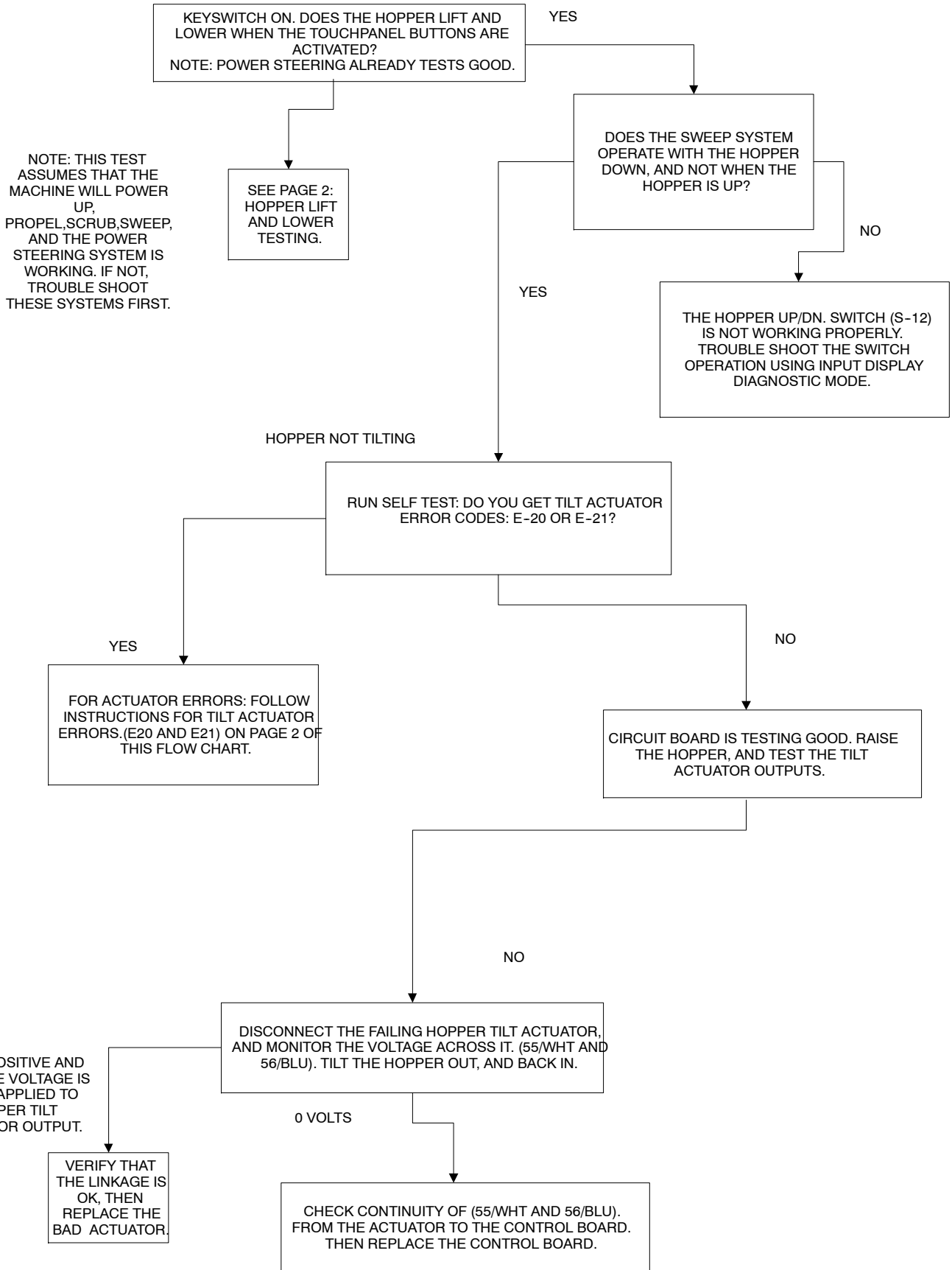

CONTENTS

	Page
INTRODUCTION	6-3
HYDRAULICS	6-4
HYDRAULIC FLUID RESERVOIR	6-4
HYDRAULIC FLUID	6-5
HYDRAULIC HOSES	6-5
ELECTRO/HYDRAULIC POWER UNIT ..	6-6
TO REPLACE ELECTRO/HYDRAULIC POWER UNIT	6-6
TO REPLACE HYDRAULIC SOLENOID	6-11
TO REPLACE HYDRAULIC TURNING MOTOR	6-15
TO REPLACE HYDRAULIC STEERING WHEEL MOTOR	6-21
TO REPLACE HOPPER LIFT CYLINDER	6-24
HYDRAULIC SCHEMATIC	6-29
HYDRAULIC HOSE DIAGRAM	6-30
EATON REPAIR INFORMATION	6-31

INTRODUCTION

The 8300 hydraulic system consists of a electro/hydraulic power unit, solenoid valve, steering wheel motor, drive unit turning motor, hopper lift cylinder, and hydraulic hoses.

HYDRAULICS

HYDRAULIC FLUID RESERVOIR

The hydraulic reservoir holds the hydraulic fluid for the hydraulic lift cylinder and the power steering unit. It is located underneath the front cover of the machine. A filler cap is mounted on top of the reservoir.

Check the hydraulic fluid level at operating temperature after every 100 hours of operation. The reservoir should be filled to 2" +/- .5" below the top of the reservoir. The top of the spring assembly that holds down the filter inside the reservoir can be used as a gauge.

Lubricate the filler cap gasket with a film of hydraulic fluid before putting the cap back on the reservoir.

Drain and refill the hydraulic fluid reservoir with new hydraulic fluid after every 500 hours of operation.

ATTENTION! Do not overfill the hydraulic fluid reservoir or operate the machine with a low level of hydraulic fluid in the reservoir. Damage to the machine hydraulic system may result.

The reservoir has a built-in filter outlet that filters hydraulic fluid before it enters the system. Replace the filter every 500 hours of operation.

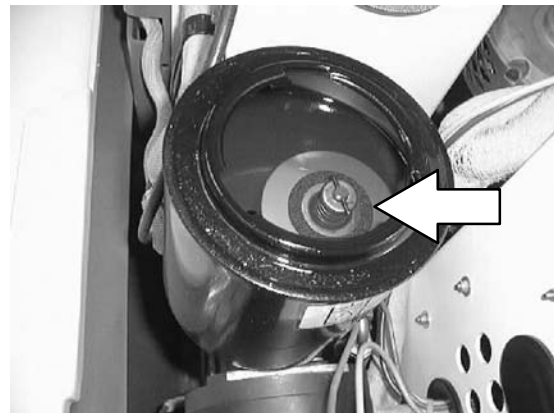
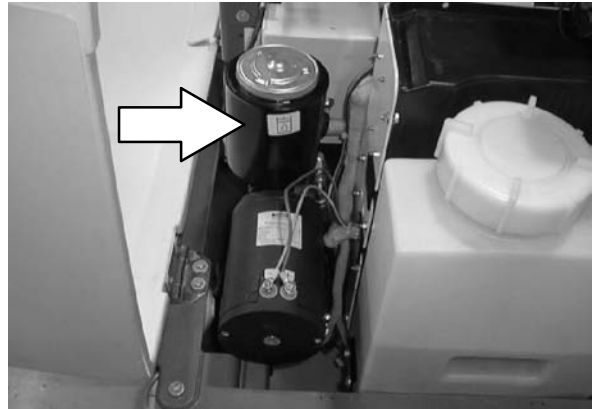

HYDRAULIC FLUID

The quality and condition of the hydraulic fluid play a very important role in how well the machine operates. Tennant's hydraulic fluid is specially selected to meet the needs of Tennant machines.

Tennant's hydraulic fluids provide a longer life for the hydraulic components.

Tennant hydraulic fluid	
Part number	Fluid weight
65870	SHP 5/20

If another hydraulic fluid is used, make sure the specifications match Tennant hydraulic fluid specifications. Using substitute fluids can cause premature failure of hydraulic components.

ATTENTION! Hydraulic components depend on system hydraulic fluid for internal lubrication. Malfunctions, accelerated wear, and damage will result if dirt or other contaminants enter the hydraulic system.

HYDRAULIC HOSES

Check the hydraulic hoses after every 500 hours of operation for wear or damage.

Fluid escaping at high pressure from a very small hole can be almost invisible, and can cause serious injuries.

See a doctor at once if injury results from escaping hydraulic fluid. Serious infection or reaction can develop if proper medical treatment is not given immediately.

FOR SAFETY: When servicing machine, use cardboard to locate leaking hydraulic fluid under pressure.

If you discover a fluid leak, contact your mechanic or supervisor.

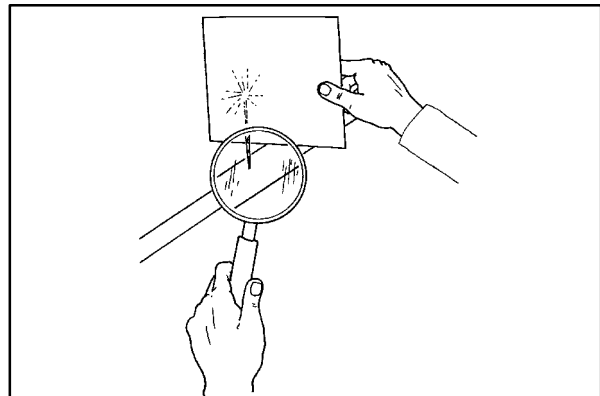

00002

HYDRAULICS

ELECTRO/HYDRAULIC POWER UNIT

The electro/hydraulic power unit uses power from the batteries to turn an electric motor, which turns a hydraulic pump. Hydraulic fluid flows to the steering hydraulic motor and is then directed to the turning hydraulic motor. The unit is self contained including fluid reservoir.

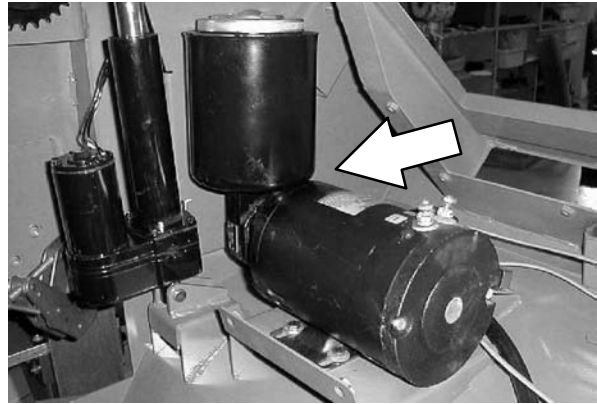

TO REPLACE ELECTRO/HYDRAULIC POWER UNIT

FOR SAFETY: Before Leaving Or Servicing Machine; Stop On Level Surface, Set Parking Brake.

1. Raise the battery cover. Unplug the battery connector.

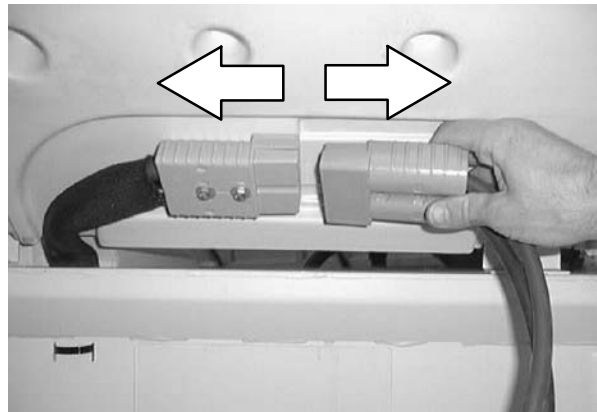

2. Open the top cover and side door.

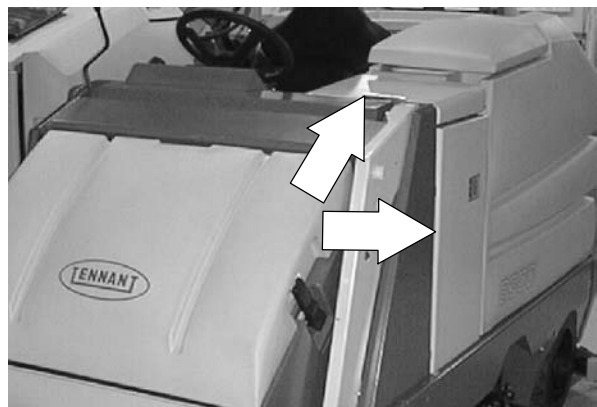

3. Remove the hopper cover, debris filter, and access panel.



4. Locate the electro/hydraulic motor on the right hand side of the sweeper assembly.

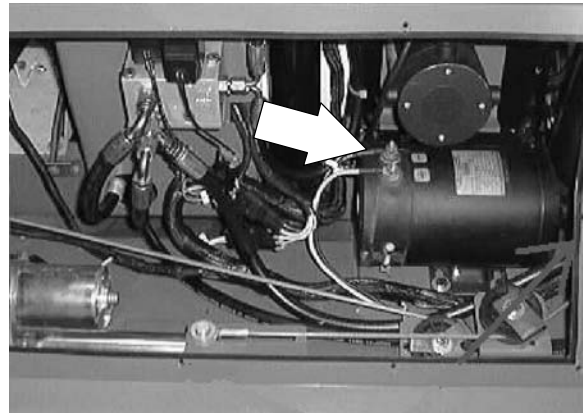

5. Disconnect the two wires leading to the electro/hydraulic motor.

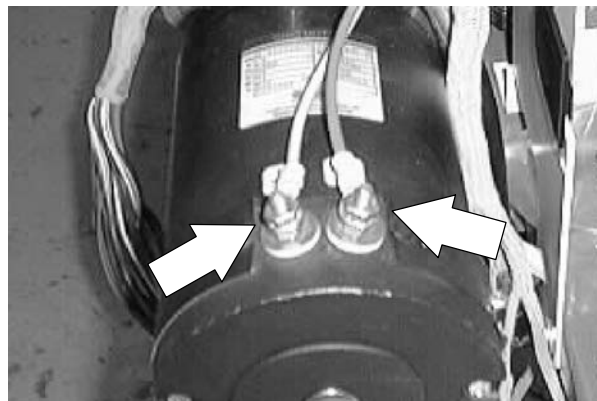

6. Mark, disconnect, and plug the three hydraulic hoses leading to the electro/hydraulic pump.

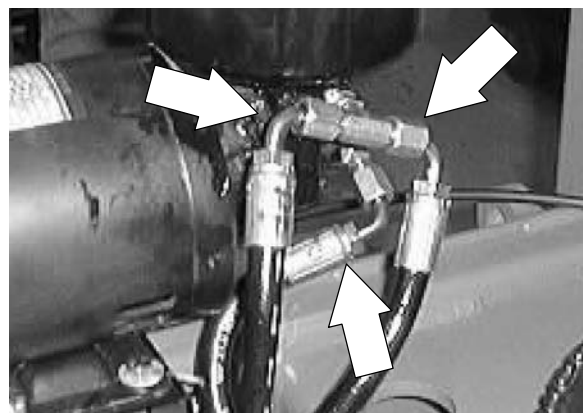

HYDRAULICS

7. Remove the four M8 hex screws holding the electro/hydraulic unit to the machine frame.

NOTE: The rear hex screws are difficult to access. Use an offset wrench and reach in through the opening between the frame lintel and the lift arm.

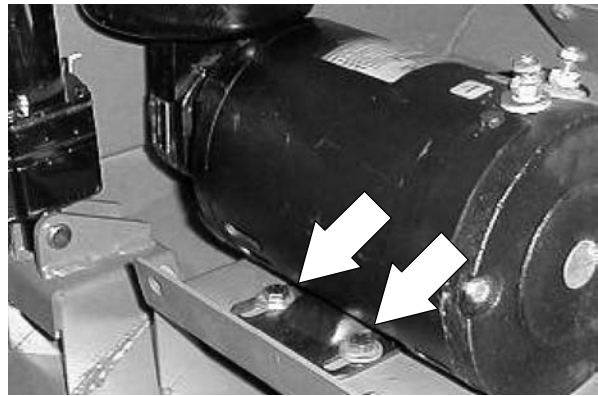

8. Remove the electro/hydraulic unit from the mount bracket.

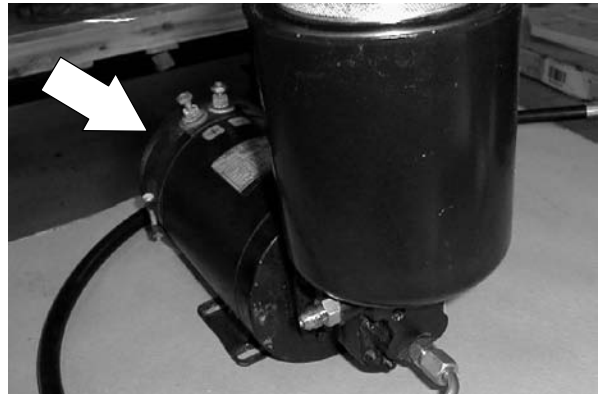

9. Remove the hydraulic fittings from the existing pump. Install into the new unit in the same orientation.

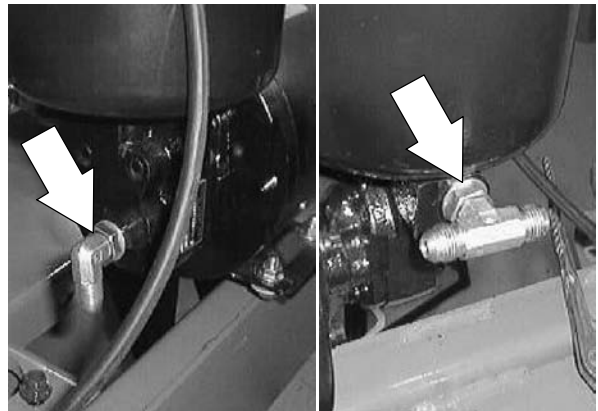

10. Position the new power unit onto the mount bracket.

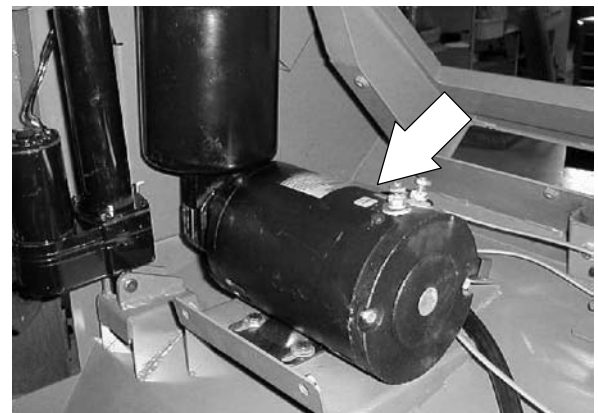

11. Reinstall the four M8 hex screws. Tighten to 18 - 24 Nm (15 - 20 ft lb).

NOTE: The rear hex screws are difficult to access. Use an offset wrench and reach in through the opening between the frame lintel and the lift arm.

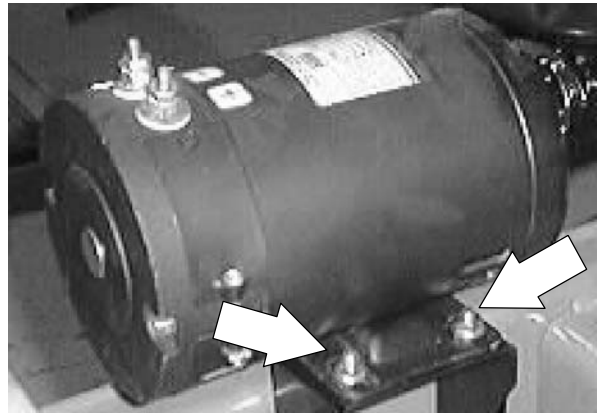

12. Reconnect the three hydraulic hoses onto the electro/hydraulic pump.

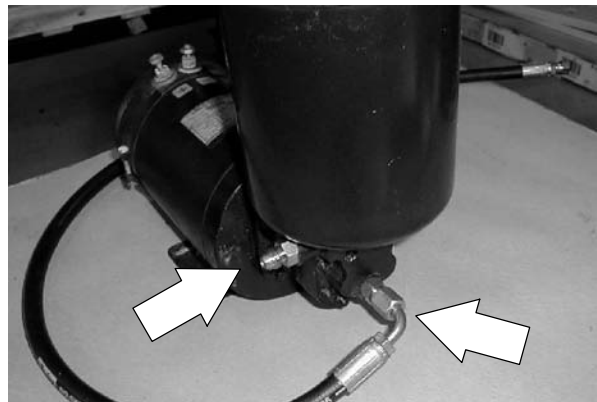

13. Reconnect the two wires leading to the electro/hydraulic motor.

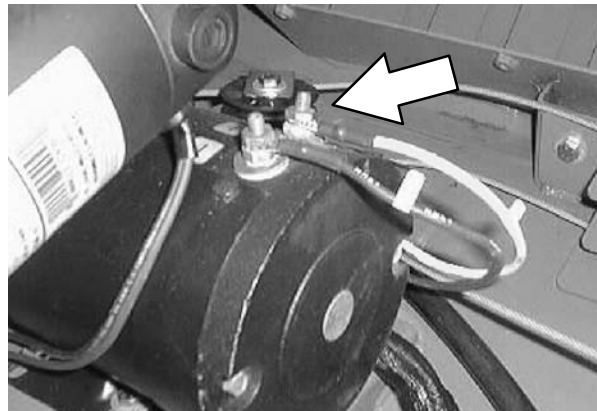

14. Fill the reservoir on the new electro/hydraulic motor with hydraulic oil. See page (6-4).



HYDRAULICS

15. Reinstall the access panel, debris filter, and hopper cover.

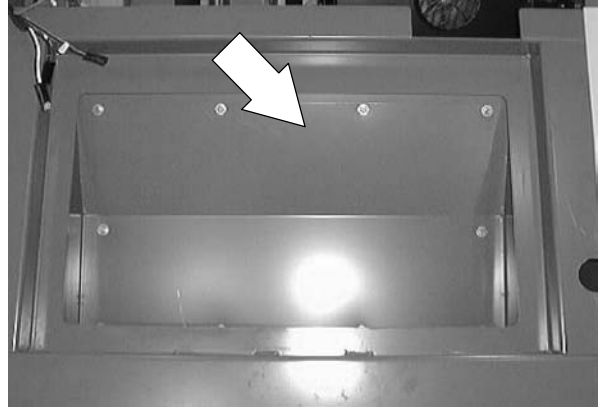

16. Close the top cover and side door.



17. Plug the battery connector into the main connector.

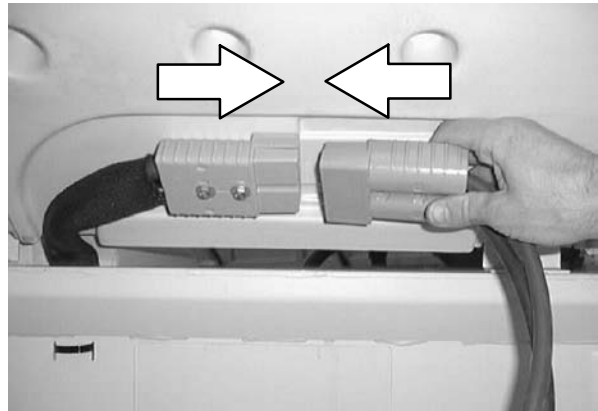

18. Close the battery cover.

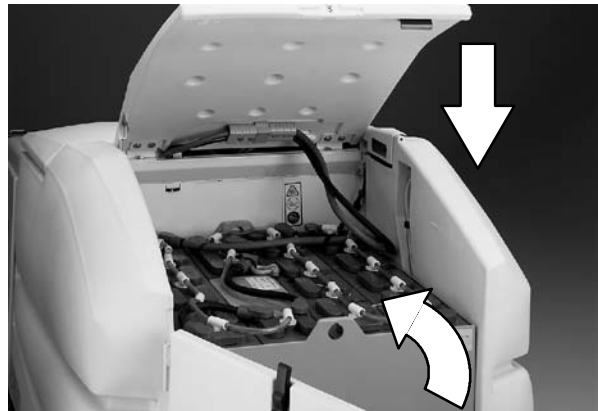

19. Start the machine. Check the power steering and hopper lift for proper operation.

TO REPLACE HYDRAULIC SOLENOID.

FOR SAFETY: Before Leaving Or Servicing Machine; Stop On Level Surface, Set Parking Brake.

1. Raise the battery cover. Unplug the battery connector.

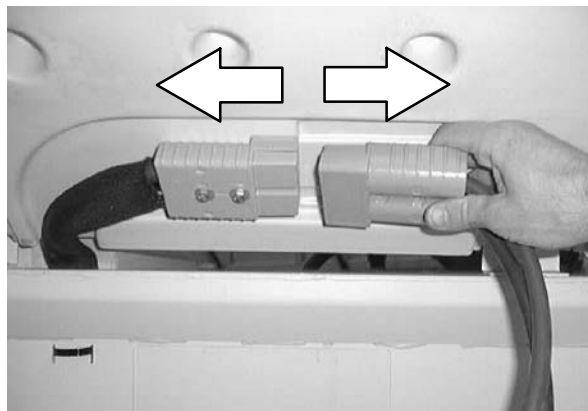

2. Open the top cover and side door.

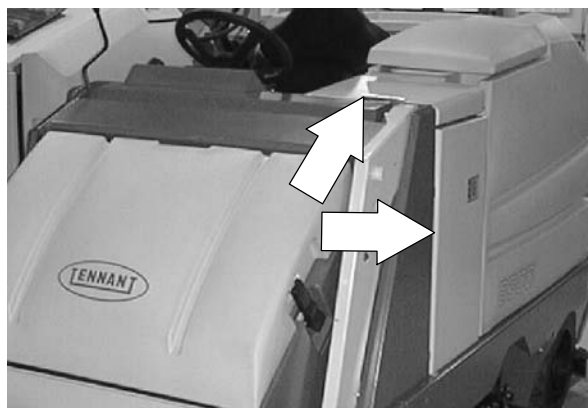

3. Remove the hopper cover, debris filter, and access panel.

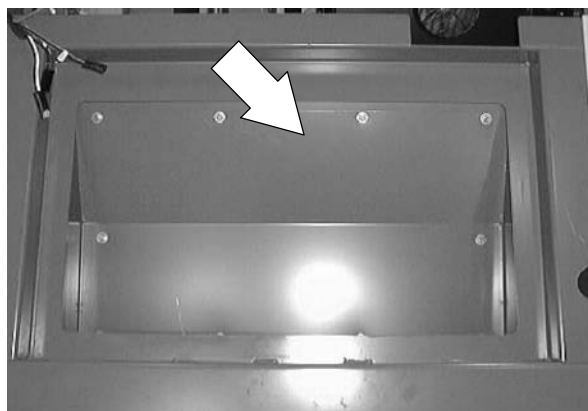

HYDRAULICS

4. Locate the hydraulic solenoid on the left hand side of the sweeper assembly, in front of the steering tower.



5. Disconnect the wires leading to the top of the valve cartridges.

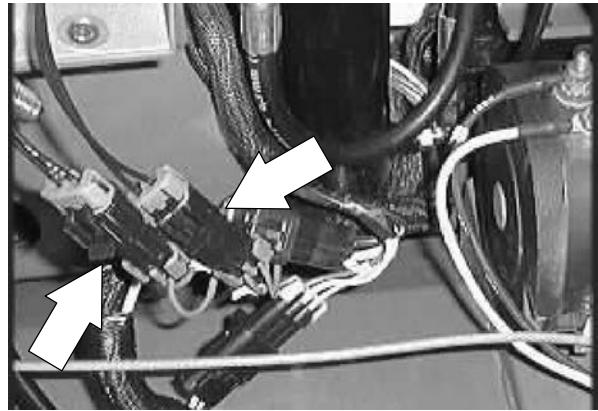

6. Mark, disconnect, and plug the five hydraulic hoses leading to the hydraulic solenoid.

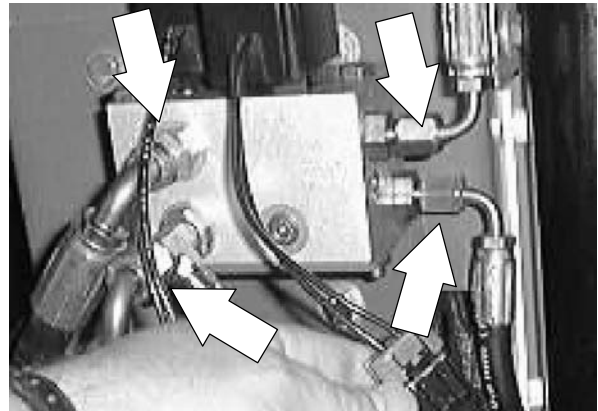

7. Remove the two M8 hex screws holding the hydraulic solenoid to the machine frame.

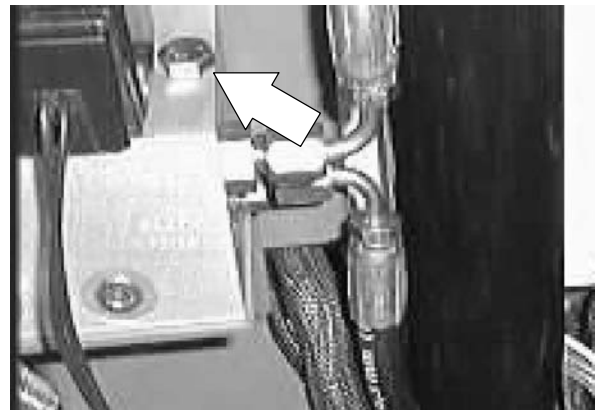

- Remove the hydraulic solenoid from the mount bracket.

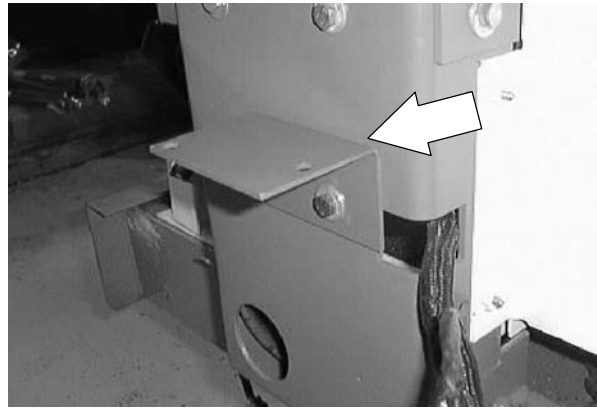

- Remove the hydraulic fittings from the existing solenoid. Install into the new solenoid block in the same orientation.

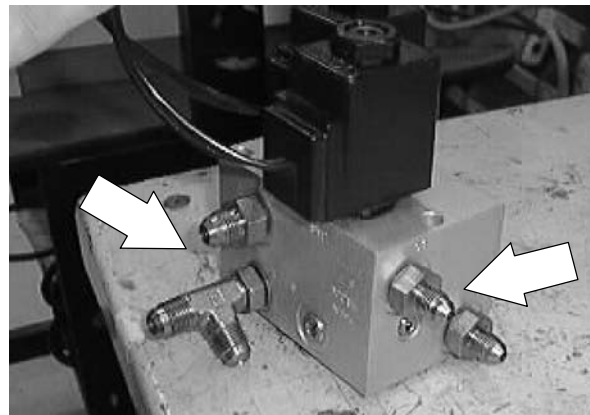

- Position the new hydraulic solenoid onto the mount bracket. Reinstall the two hex screws and tighten to 18 - 24 Nm (15 - 20 ft lb).

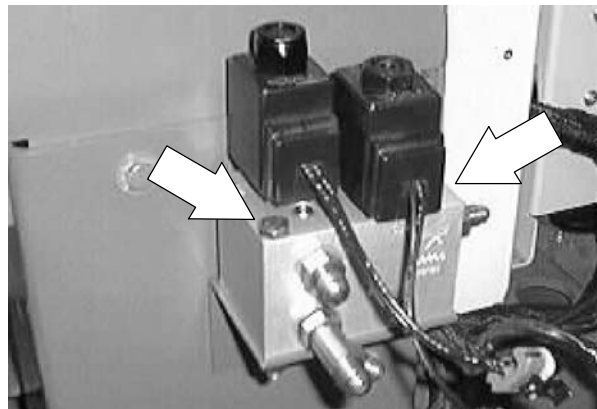

- Connect the five hydraulic hoses to the new hydraulic solenoid.

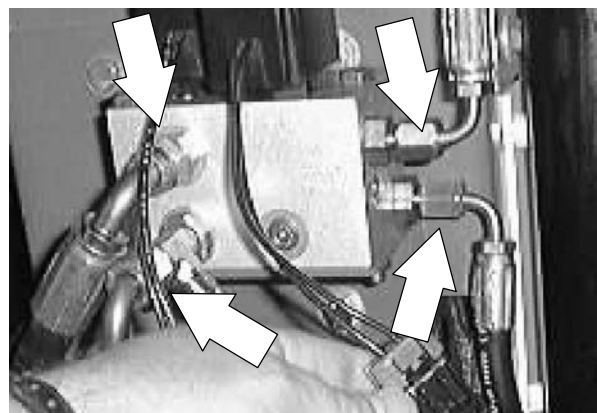

HYDRAULICS

12. Plug the connectors from the new solenoid to the main harness. See ELECTRICAL SCHEMATIC in the ELECTRICAL section.

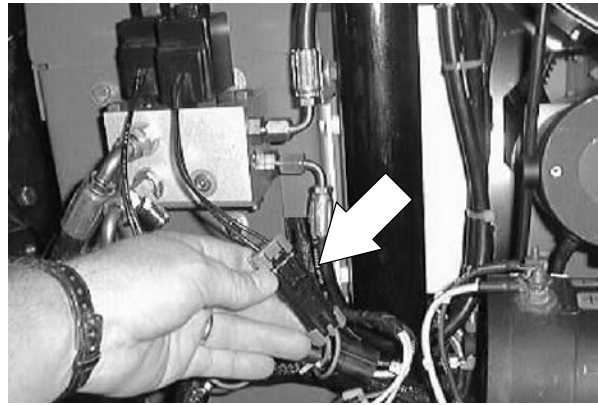

13. Reinstall the access panel, debris filter, and hopper cover.



14. Close the top cover and side door.



15. Plug the battery connector into the main connector. Close the battery cover.

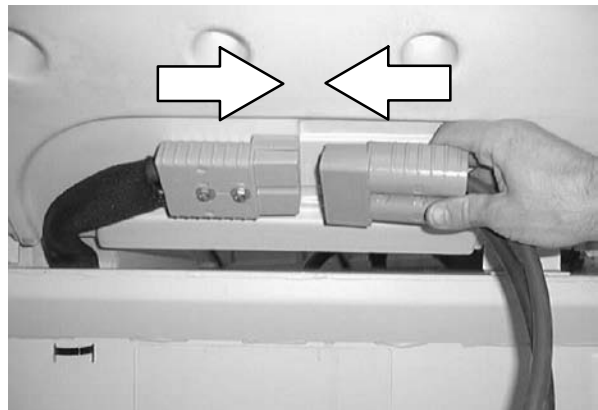

16. Start the machine. Check the power steering and hopper lift for proper operation.

TO REPLACE HYDRAULIC TURNING MOTOR

FOR SAFETY: Before Leaving Or Servicing Machine; Stop On Level Surface, Set Parking Brake.

1. Raise the battery cover. Unplug the battery connector.

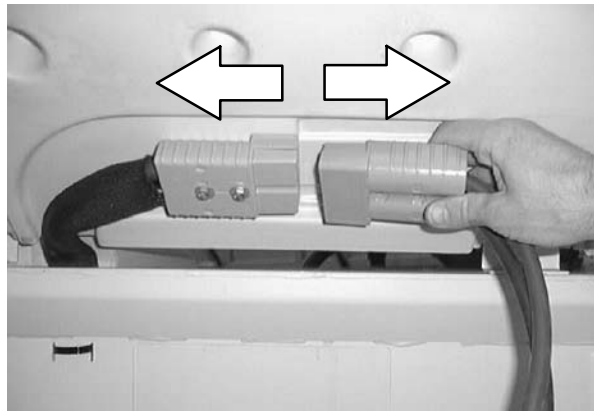

2. Remove the plastic drive motor cover.



3. Remove the inside floor plate.

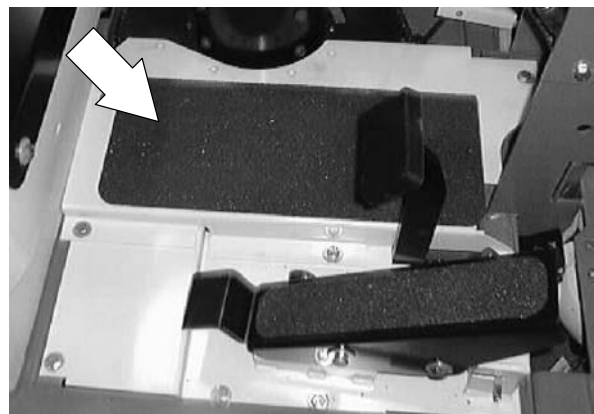

HYDRAULICS

4. Loosen the hardware holding the hydraulic steering motor to the machine frame. *Push the motor and sprocket in toward the large sprocket.*

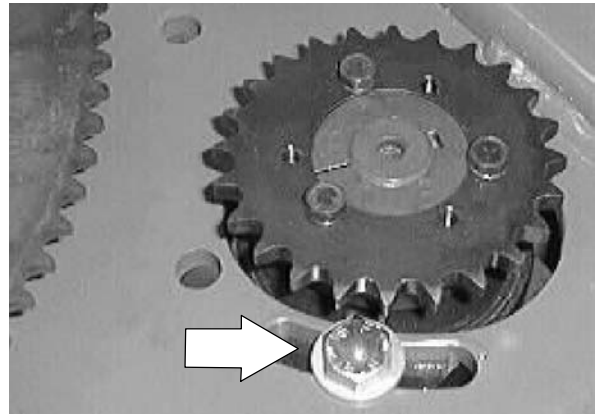

5. Remove the steering chain from the steering motor sprocket.

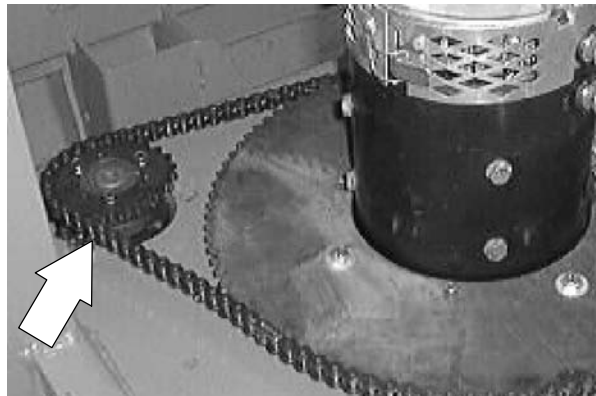

6. Remove the three hex screws holding the steering motor sprocket to the motor hub.

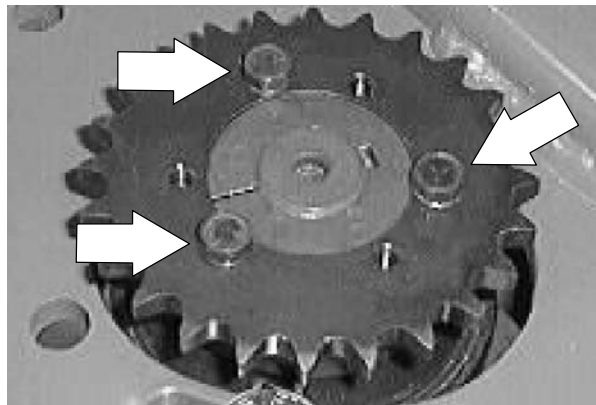

7. Thread the three screws into the open holes on top of the steering sprocket.

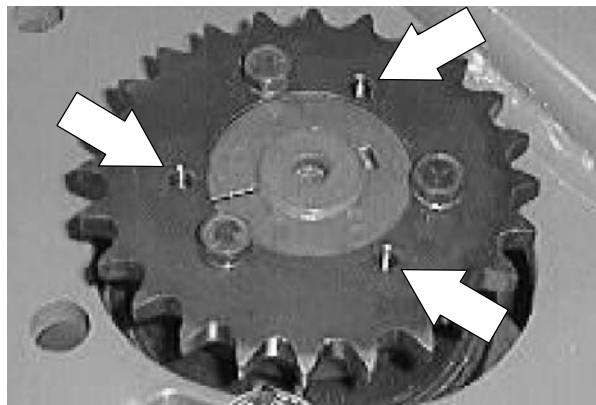

8. Tighten the screws to push the sprocket off the motor hub.



9. Mark, disconnect, and plug the two hydraulic hoses leading to the steering motor.
Note routing of hoses into frame.

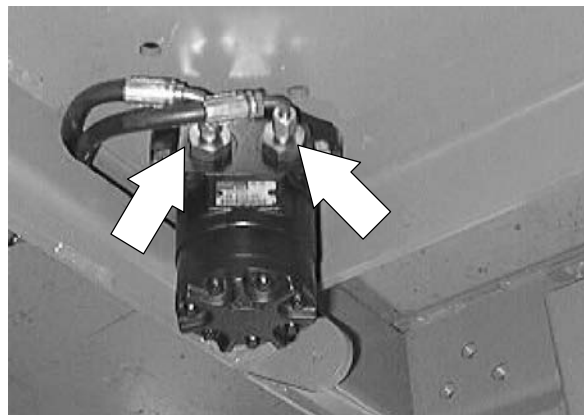

10. Remove steering motor hardware. Remove the motor from the machine.

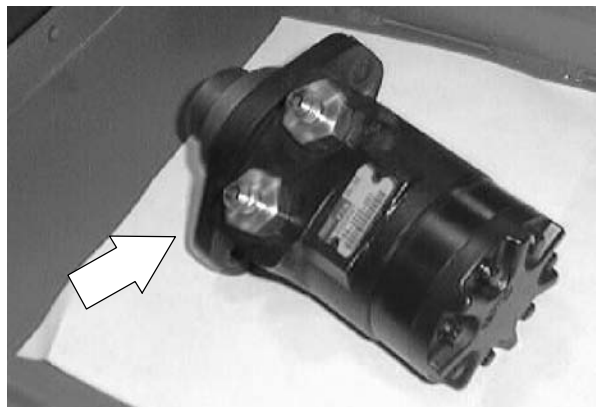

11. Remove the hydraulic fittings and taper lock hub from the existing motor. Install the fittings and hub on the new motor. *Position the top of hub even with the top of the motor shaft. Make sure the key is installed on the motor shaft.*

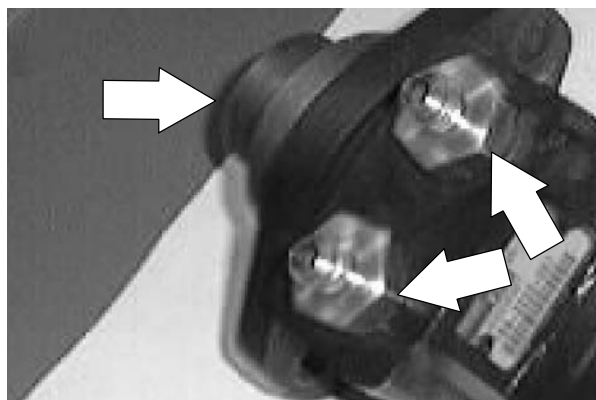

HYDRAULICS

12. Install the new motor in the machine. Leave the hardware loose for now.

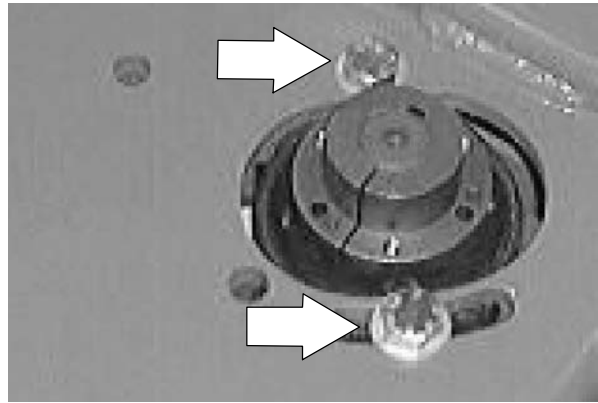

13. Reconnect the two hydraulic hoses to the new motor. *Note routing of hoses into frame.*

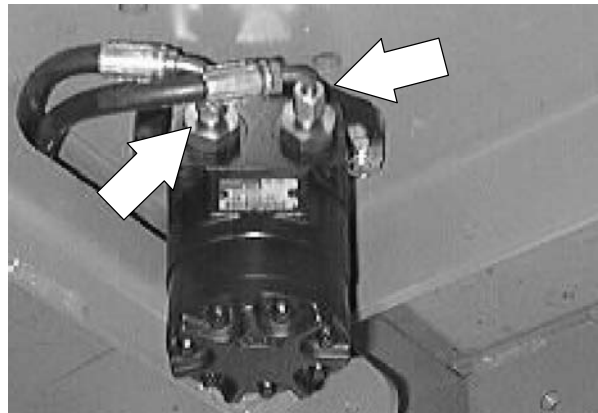

14. Reinstall the small steering chain sprocket onto the motor hub. Install the three hex screws. Leave loose for now.

NOTE: Use loctite blue 242 on the threads.

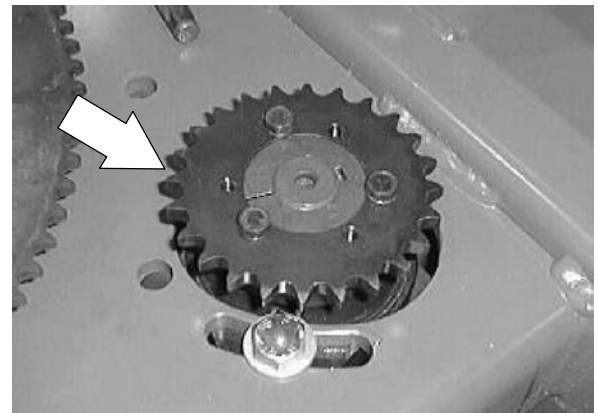

15. Use a straight edge to align the small sprocket with the large sprocket. Tighten the three hex screws to 11 - 14 Nm (7 - 10 ft lb).

NOTE: Use loctite blue 242 on the threads.

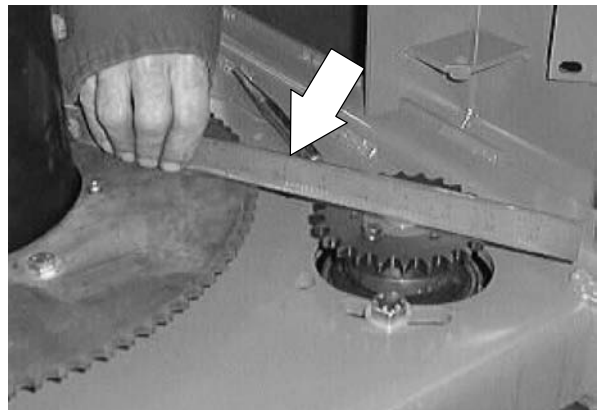

16. Reinstall the steering chain onto the small sprocket.

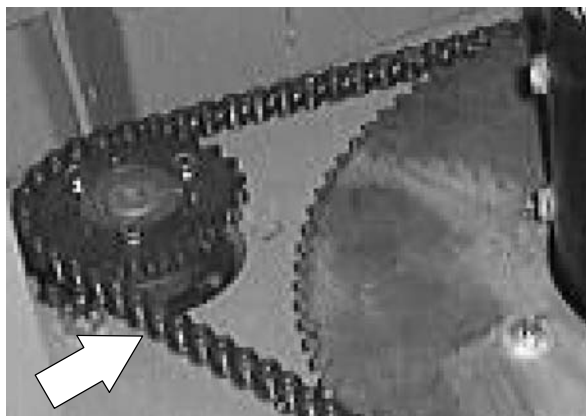

17. Use a pry bar to move the hydraulic steering motor away from the large sprocket until the chain is tight. Tighten the motor mounting hardware to 37 - 48 Nm (26 - 34 ft lb).

NOTE: The tension of the chain should be checked after the first 50 hours of operation and every 200 hours thereafter. The deflection should be 0.12 to 0.25 in (3 to 6 mm) between the steering sprocket and the idler sprocket when the steering wheel is turned the tightest position either direction.

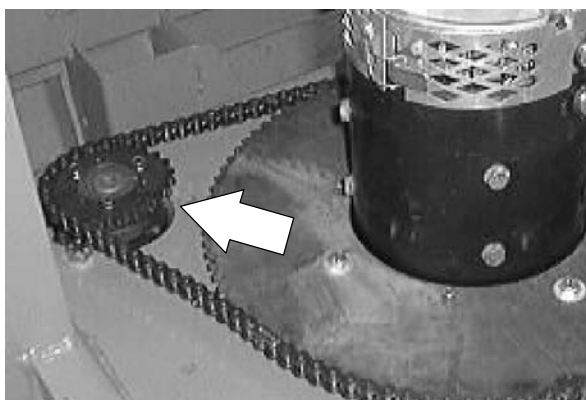

18. Reinstall the inside floor plate.

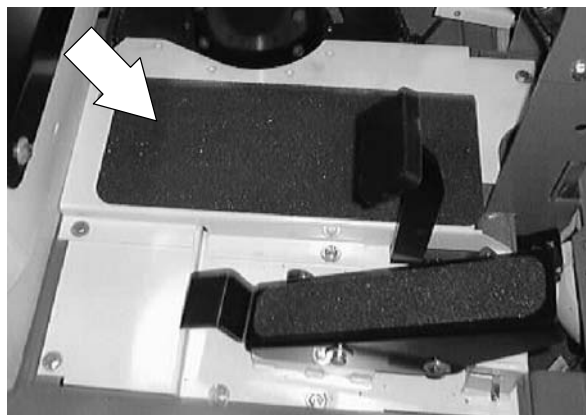

19. Reinstall the plastic drive motor cover.



HYDRAULICS

20. Plug in the battery connector. Close the battery cover.

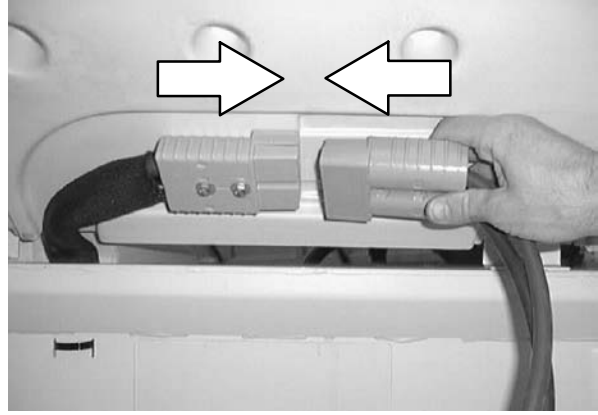

21. Close the top cover and side door.

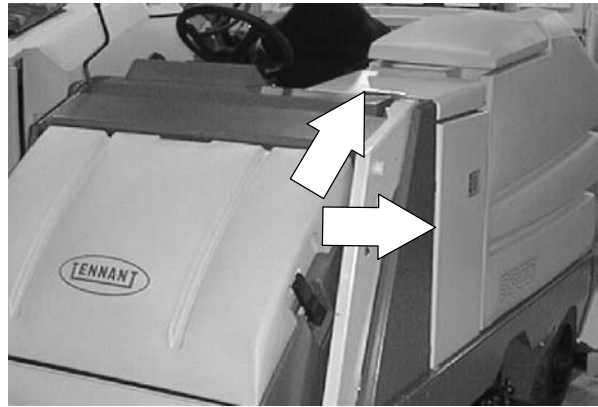

22. Start and operate the machine. Check the steering for proper operation.

TO REPLACE HYDRAULIC STEERING WHEEL MOTOR

FOR SAFETY: Before Leaving Or Servicing Machine; Stop On Level Surface, Set Parking Brake.

1. Raise the battery cover. Unplug the battery connector.

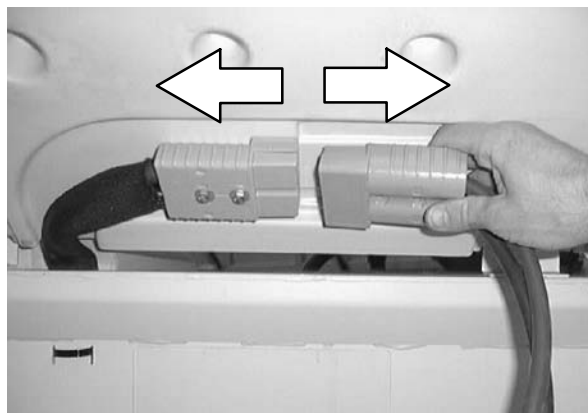

2. Open the top cover and side door.

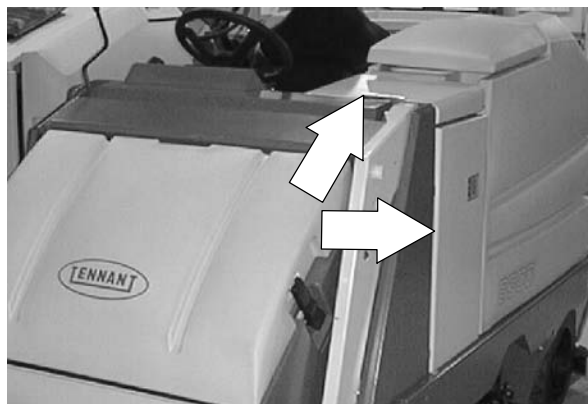

3. Mark, disconnect, and plug the five hydraulic hoses leading to the steering wheel motor. *Note routing of hoses through frame.*

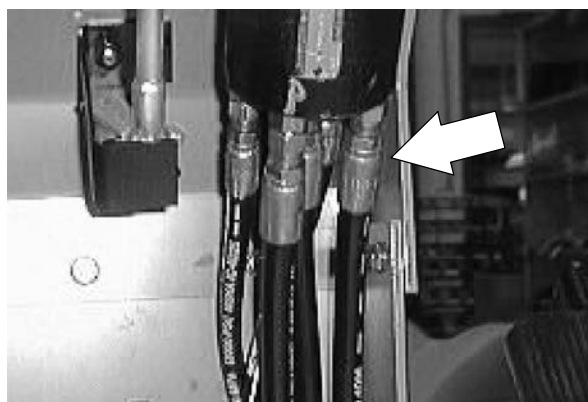

HYDRAULICS

4. Remove the three screws holding the steering wheel motor to the steering column.



5. Pull the steering motor down off the bottom of the steering column. Remove the motor from the machine. *Note the orientation of the spacer between the motor and the column.*

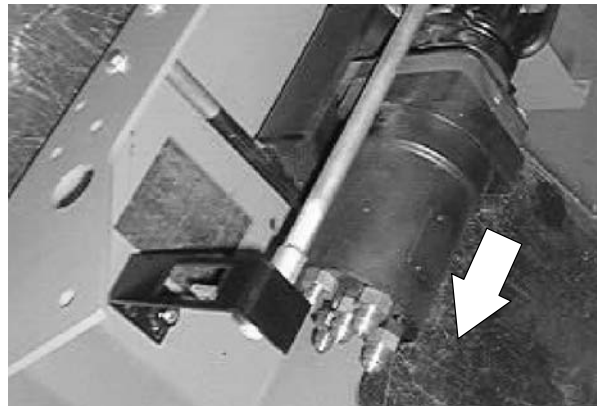

6. Remove the hydraulic fittings from the existing motor and install in the new motor.

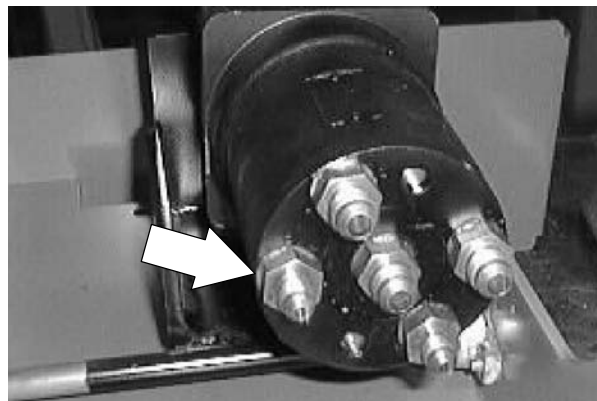

7. Position the new motor into the bottom of the steering column. *The splines on the motor shaft must line up with the splines in the steering column. Note the orientation of the spacer between the motor and the column.* Hand tighten the hardware tight.



8. Reconnect the hydraulic hoses to the steering motor. *Start at the back hose and work your way forward.*

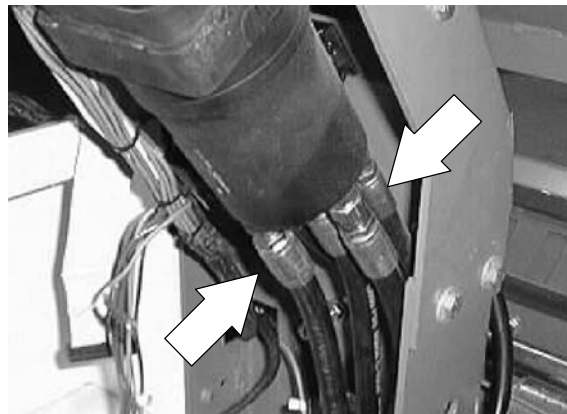

9. Plug in the battery connector. Close the battery cover.

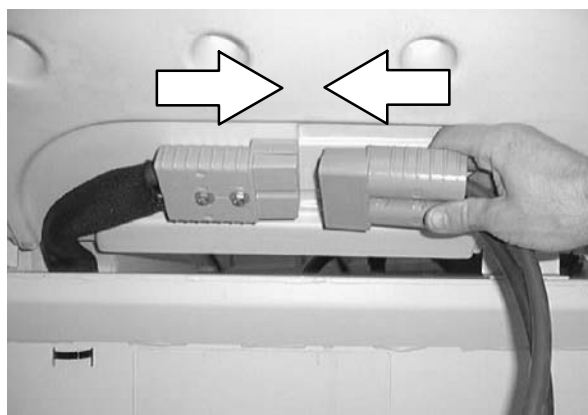

10. Close the top cover and side door.

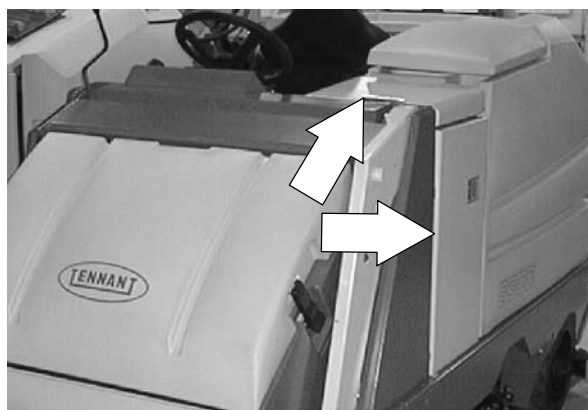

11. Start and operate the machine. Check the steering for proper operation.

HYDRAULICS

TO REPLACE HOPPER LIFT CYLINDER

FOR SAFETY: Before Leaving Or Servicing Machine; Stop On Level Surface, Set Parking Brake.

1. Start the machine and raise the hopper. Engage prop arm, lower the hopper onto the prop arm. Turn off the machine.



2. Raise the battery cover. Unplug the battery connector.

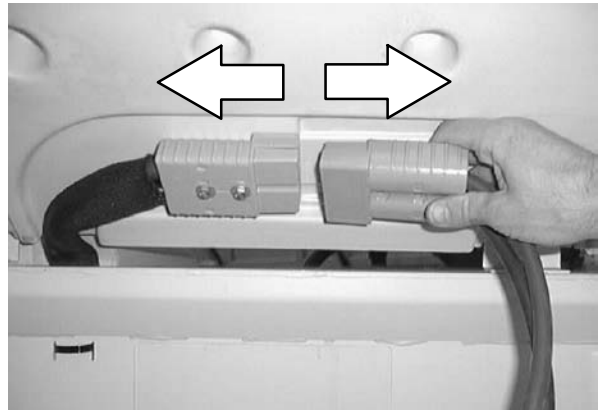

3. Remove the hopper cover, debris filter, and access panel.



4. Locate the hopper lift cylinder at the center of the machine, next to the steering support.



5. Mark, disconnect, and plug the two hydraulic hoses leading to the lift cylinder.

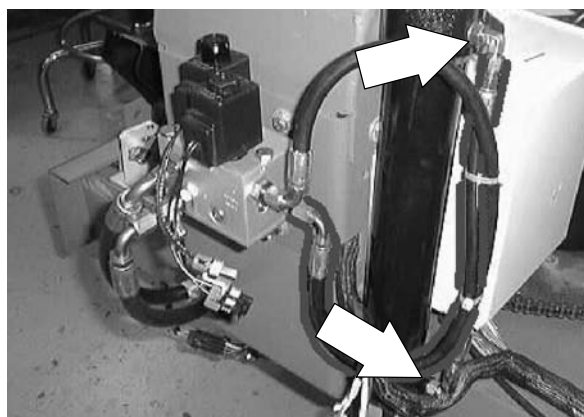

6. Remove the large "C" clip on the clevis pin at the bottom of the lift cylinder. Remove the clevis pin from the cylinder.



7. Remove the hex screw holding the upper clevis pin to the lift arm lug.

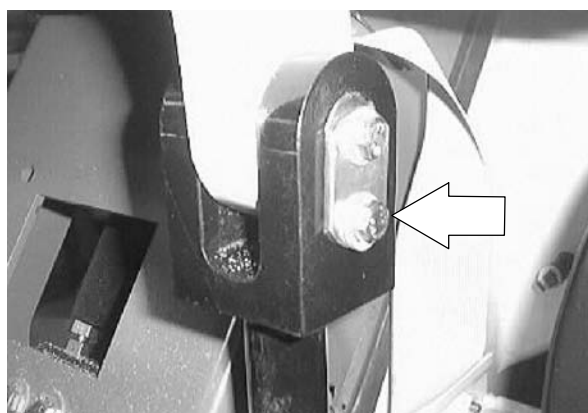

HYDRAULICS

8. Hold the cylinder and remove the upper clevis pin.

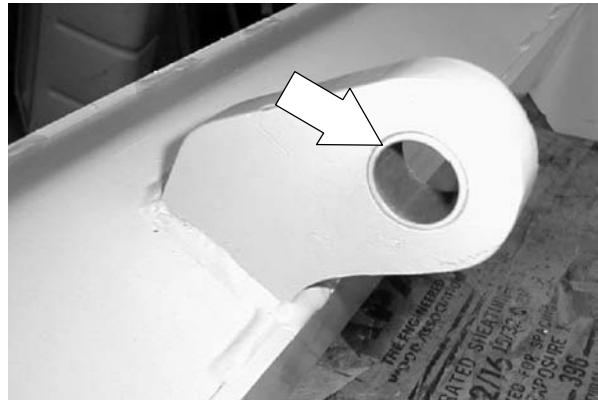

9. Remove the cylinder from the machine through the opening between the lift arm and the frame lintel.



10. Remove the hydraulic fittings from the existing cylinder and install in the new cylinder in the same orientation.

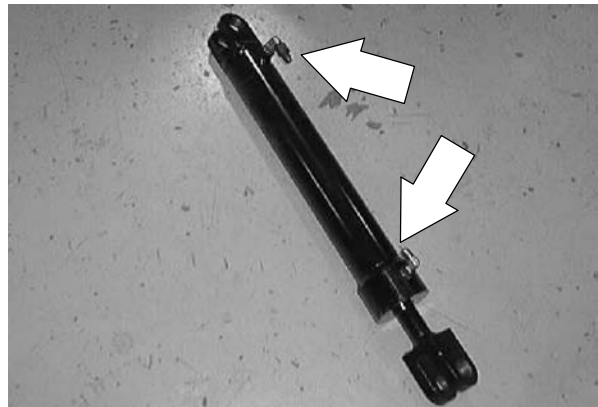

11. Position the new cylinder into the machine through the opening between the lift arm and the frame lintel.



12. Reinstall the upper cylinder pin. Reinstall the hex screw and tighten to 8 - 10 Nm (6 - 8 ft lb).

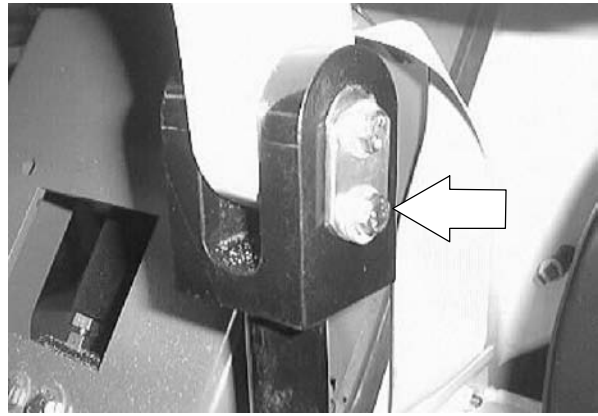

13. Reinstall the lower clevis pin and "C" clip.



14. Reconnect the hydraulic hoses to the new lift cylinder. See schematic in this section.

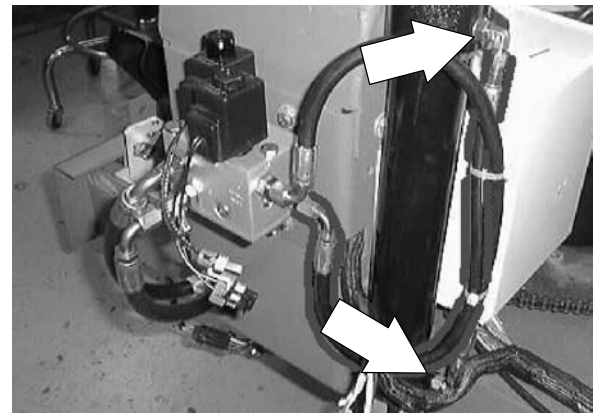

15. Plug in the battery connector. Close the battery cover.

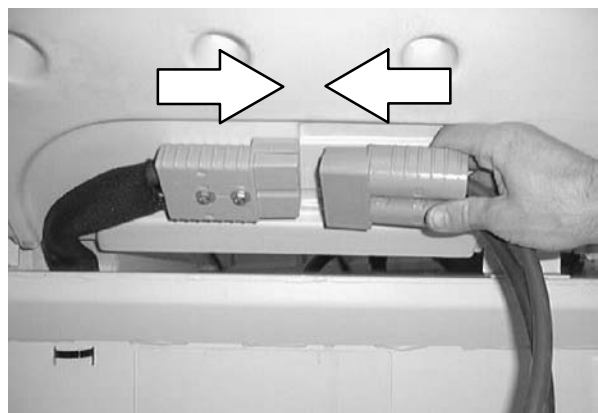

HYDRAULICS

16. Reinstall the access panel, debris filter, and hopper cover.

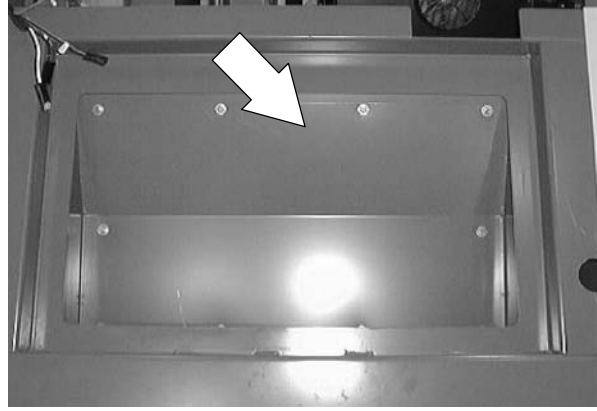

17. Start the machine and raise the hopper. Disengage the prop arm. Lower the hopper. Check the lift cylinder for proper operation.



HYDRAULIC SCHEMATIC

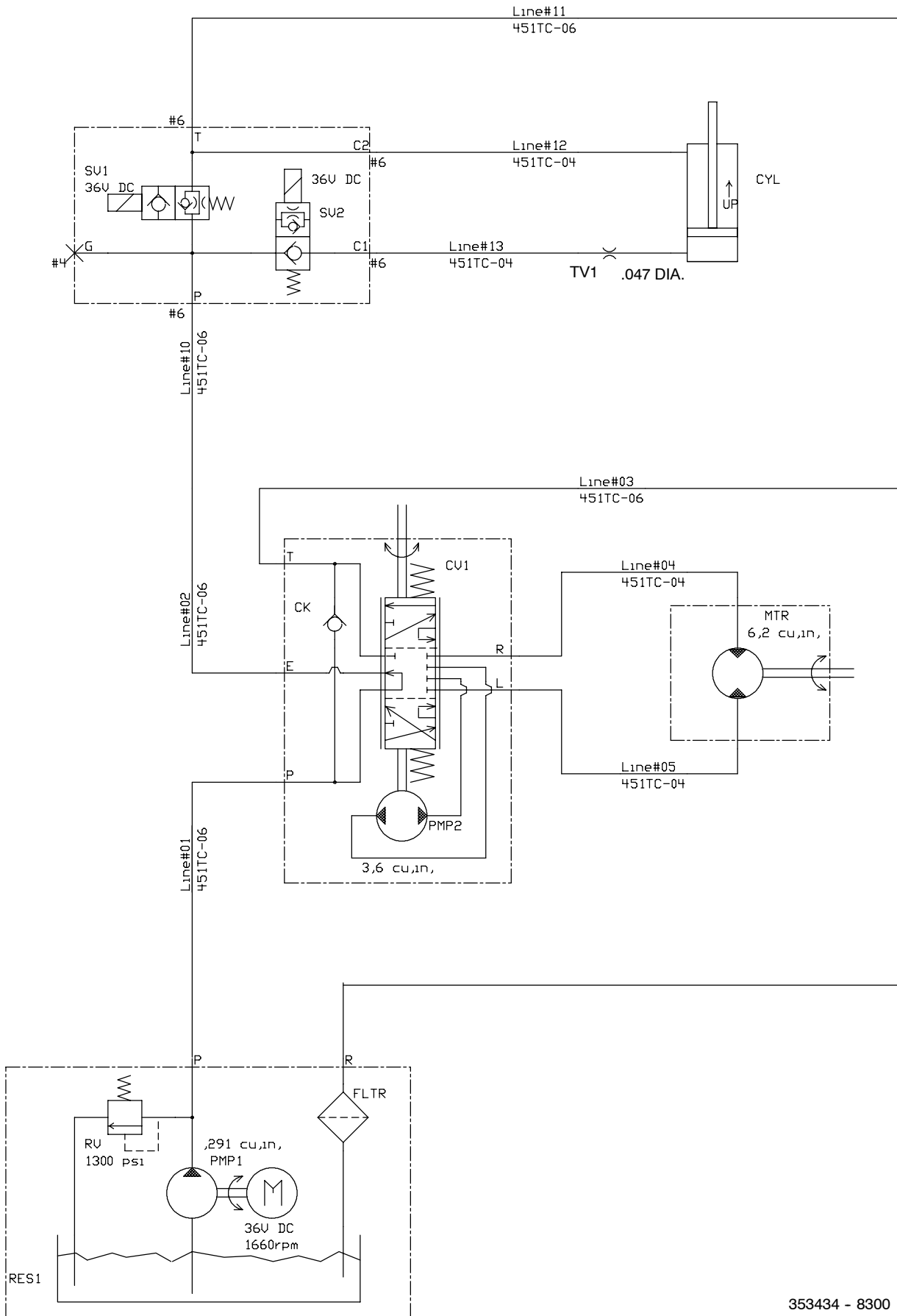

353434 - 8300

HYDRAULIC HOSE DIAGRAM

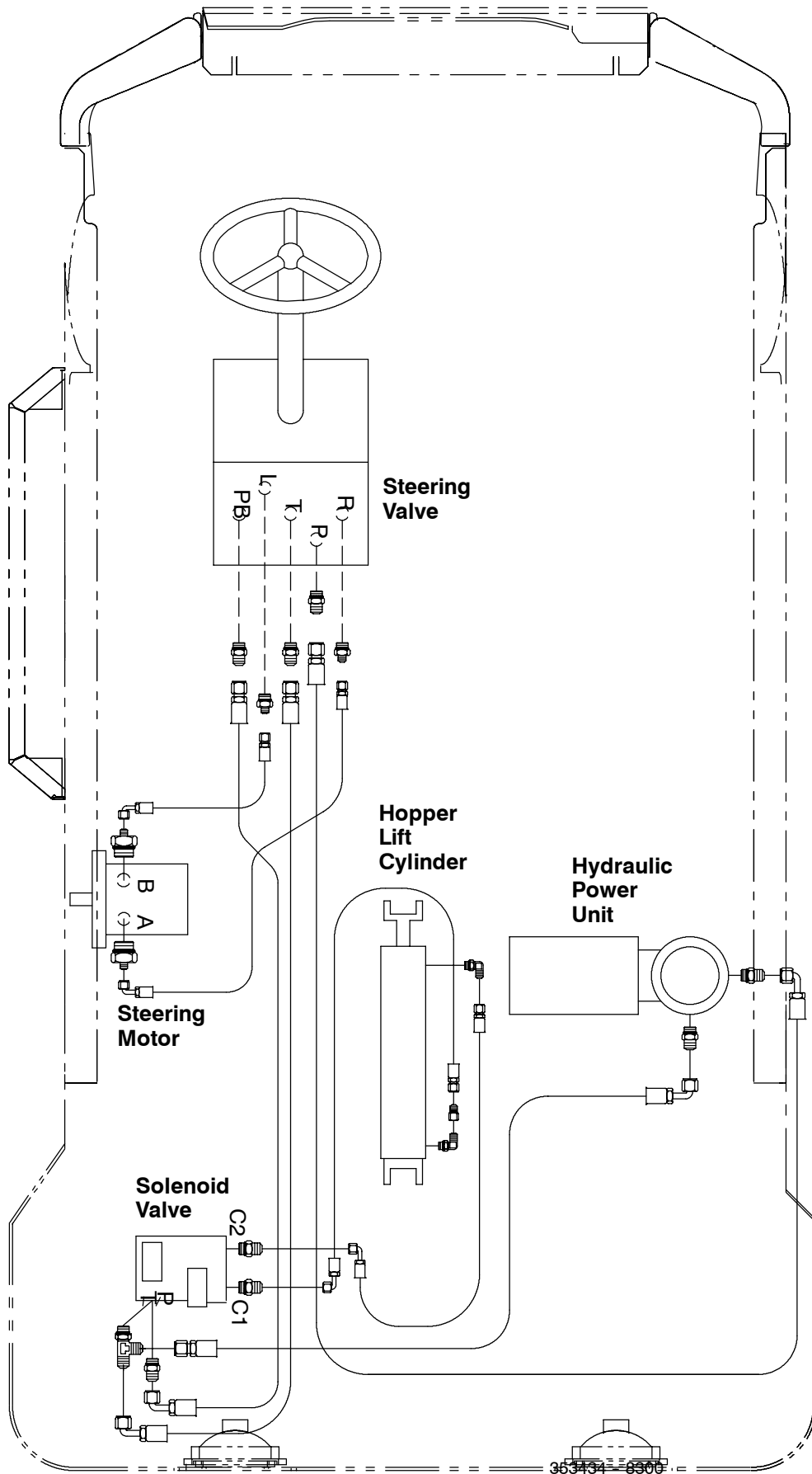

363454-0500



Repair Information

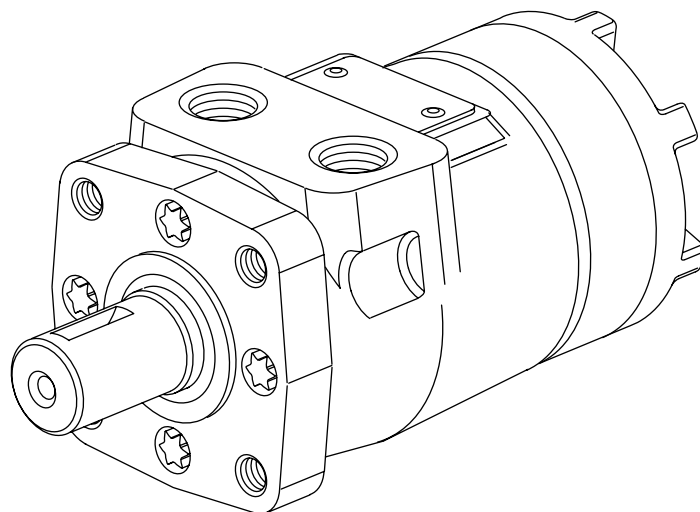

T Series
General Purpose Geroler[®] Motor

001

Parts Drawing

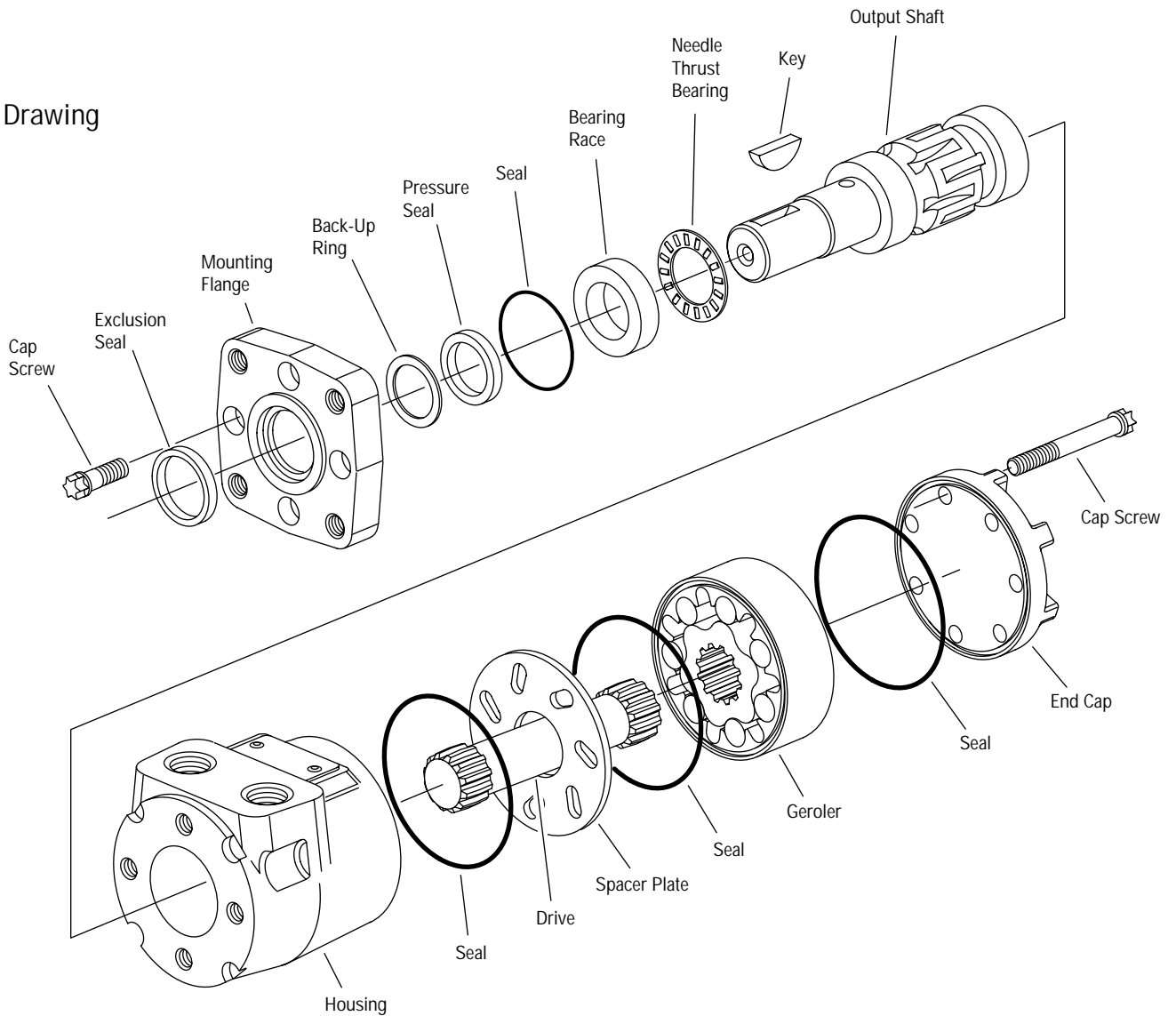

Tools Required

- Torque wrench (34 Nm [300 lb-in] capacity)
- 300 - 400 mm [12 - 16 in.] breaker bar
- 5/16 in. – 6 point (E10 Drive) socket no. 64489-000* (Heavy Duty 56 Nm [500 lb-in] capacity)
- Small blade screwdriver
- 3/16 in. hex key
- Shaft seal installation tool P/N 600523*
- Shaft sleeve or bullet
 - P/N 600304* for 1 inch dia. shaft
 - P/N 600466* for 7/8 inch dia. shaft

*Tools available, through Eaton order entry department.

T Series Geroler Motors

Disassembly

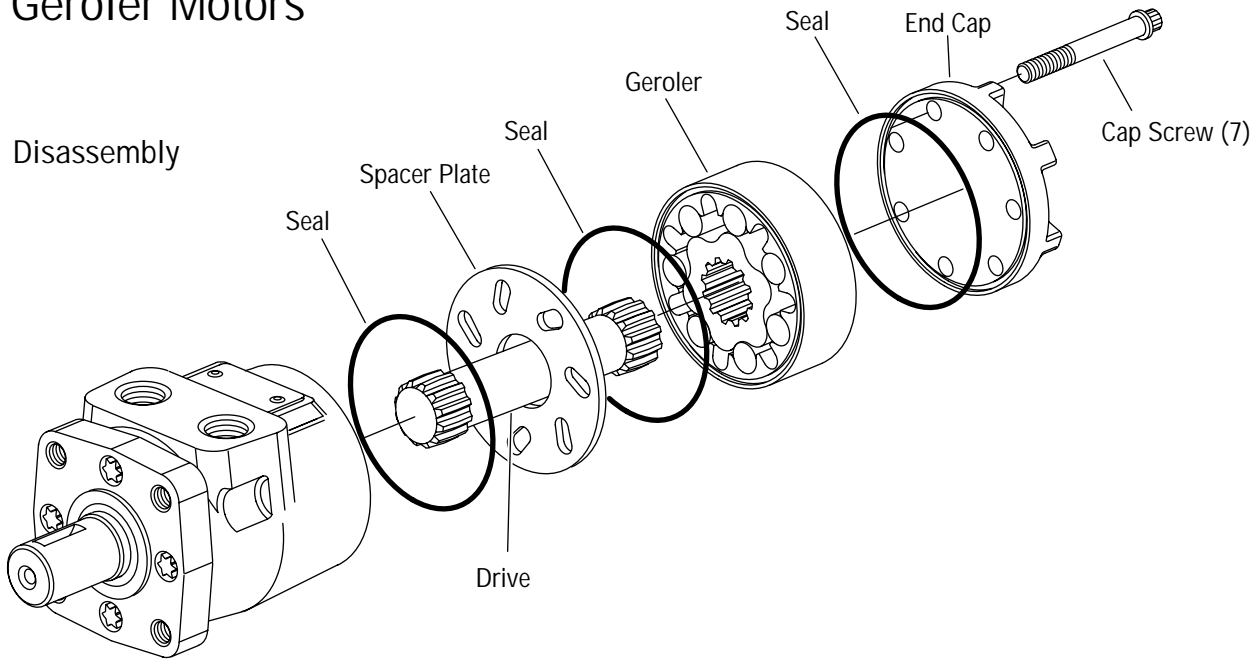

Figure 1

Cleanliness is extremely important when repairing hydraulic motors. Work in a clean area. Before disconnecting the hydraulic lines, clean the port area of the motor. Before disassembly, drain the oil from the motor. Then plug the ports and thoroughly clean the exterior of the motor. Check the output shaft, remove any burrs, nicks, or sharp edges.

1 Clamp the motor in a vise so the shaft is vertical and the end cap is on top. Clamp on the mounting flange using just enough clamping force to hold the motor securely. Protect the mounting flange with soft vise jaws.

2 Remove the seven cap screws from the end cap and disassemble the motor as shown in Figure 1. Do not disassemble the Geroler.

3 Un-clamp the motor and remove the output shaft, thrust needle bearing, and thrust bearing race (see Figure 2).

4 Clamp the motor in a vise so the mounting flange is on top. Clamp across the port area. Do not clamp on the motor housing. Use just enough clamping force to hold the motor securely.

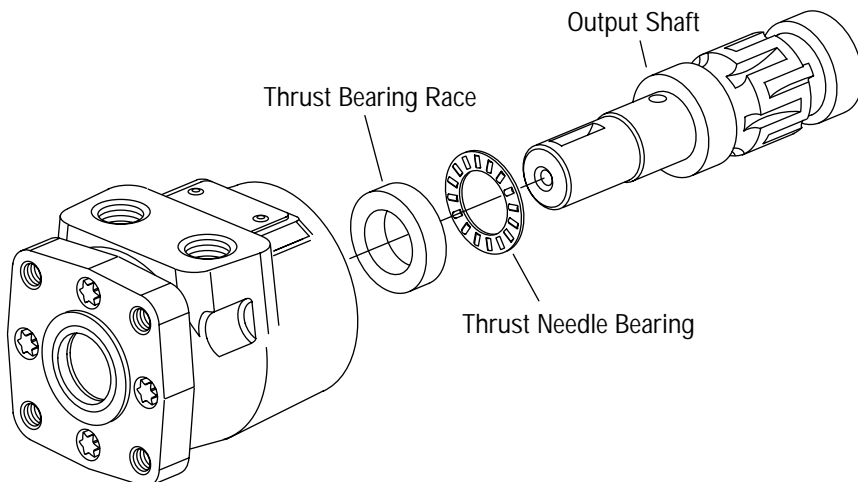

Figure 2

Disassembly

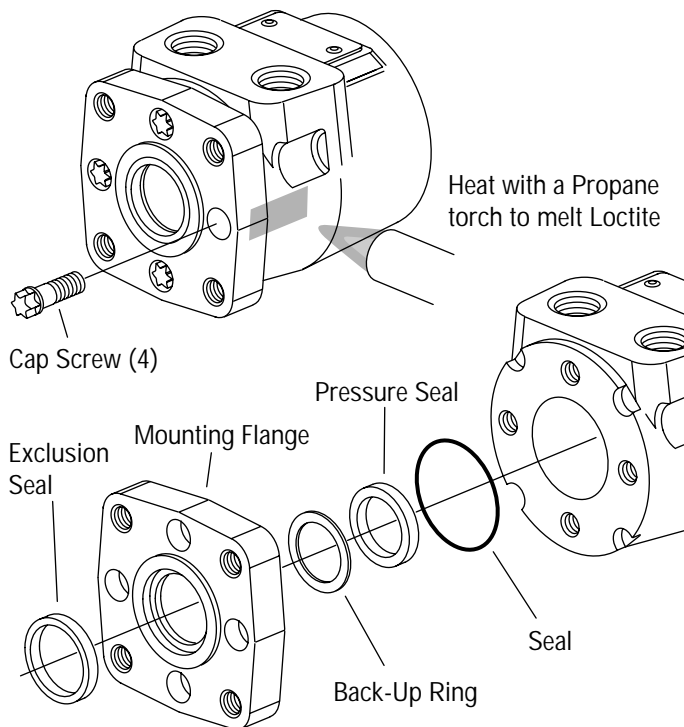

Figure 3

5 Remove the four cap screws that hold the mounting flange to the motor housing.

Caution: These screws were Loctited during assembly. Do Not exceed 56 Nm [500 lb-in] of removal torque.

If the Loctite is holding the screws too tightly, heat the motor housing, with a propane torch, while turning the screw. Apply heat to where the screw threads into the motor housing, see figure 3. Apply just enough heat to remove the screw, do not overheat the motor housing or mounting flange.

6 Remove the mounting flange from the motor housing. The exclusion seal, pressure seal, and back-up ring will come off with the mounting flange.

7 Carefully remove the exclusion seal, pressure seal, and back-up ring from the mounting flange. A seal removal tool may be fabricated by bending and rounding the end of a small blade screwdriver, see figure 4.

Important: Do not damage the mounting flange where the shaft passes through it.

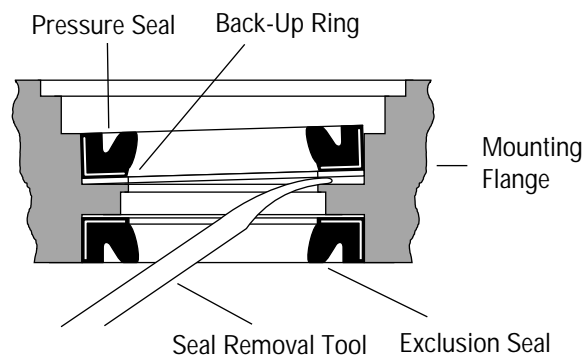

Figure 4

Reassembly

Check all mating surfaces. Replace any parts with scratches or burrs that could cause leakage. Wash all metal parts in clean solvent. Blow them dry with pressurized air. Do not wipe parts dry with paper towels or cloth as lint in a hydraulic system will cause damage. Check the key way and chamfered area of the output shaft; remove any nicks, burrs, or sharp edges that could damage the shaft seals during reassembly.

Note: Always use new seals when reassembling hydraulic motors. Refer to parts list 6-146 for seal kit part numbers, replacement parts, and ordering information.

Important: During reassembly lubricate the new seals with a petroleum jelly such as Vaseline®. Also lubricate machined surfaces and bearings with clean hydraulic fluid.

8 Remove all of the old Loctite® from the mounting flange cap screws and their threaded holes. The threads must be clean and dry for the new Loctite to hold properly.

9 Lubricate and install the output shaft, needle thrust bearing, and bearing race into the housing.

Important: Do not permit oil to get into the four threaded holes.

10 Lubricate the exclusion seal and press it into its seat in the mounting flange. Figure 5 shows the correct seal orientation.

T Series Geroler Motors

Reassembly

11 Lubricate and install the back-up ring and pressure seal. Use seal installation tool no. 600523 to press the pressure seal into place (see Figure 5).

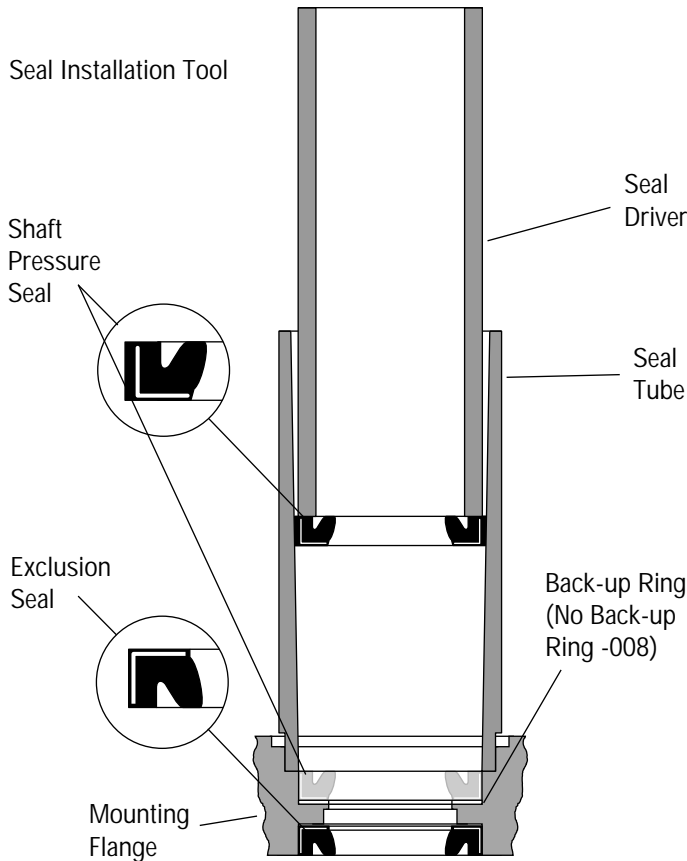

Figure 5

Important: Be sure the exclusion seal and pressure seal are undamaged and properly seated.

12 Apply three or four drops of Loctite 277 to the threads of the four holes in the motor housing where the mounting flange will be attached. Apply the Loctite so that it coats the threads. Remove all excess Loctite.

13 Install a protective sleeve or bullet over the output shaft. Lubricate the inner edges of the exclusion and pressure seals. Lubricate and install the 49 mm [1 15/16 in.] diameter o-ring seal on the mounting flange. Then slide the mounting flange down over the shaft.

14 Remove the protective sleeve and install the four cap screws. Tighten the cap screws, in a criss-cross pattern, to 28 Nm [250 lb-in]. Be sure the output shaft does not fall out of the housing.

Important: The Loctite must cure completely before the motor is put into service. Loctite curing time is six hours. Use of Loctite Primer reduces curing time to 15 minutes. Follow the instructions on the Loctite package.

15 Clamp the motor in the vise so the output shaft is vertical and down. Clamp on the mounting flange.

16 Pour clean hydraulic fluid into the motor to provide start-up lubrication.

17 Lubricate and install one of the three largest diameter seals in the groove in the motor housing.

18 Install the drive.

Note: If the splined ends of the drive are different lengths, install the longer end into the shaft.

Motor Timing

19 Align shaft timing dot with any bolt hole. Bolt hole will be used for timing reference.

20 Install spacer plate, and note the position of the threaded hole in housing aligned with the timing dot on shaft.

Important: Be sure the slots in the spacer plate provide passage for hydraulic fluid as well as the cap screws. If the spacer plate is flipped the motor will not operate.

21 Lightly stretch, lubricate and install the second of three large diameter seals in the groove in the Geroler.

22 Install the Geroler.

Standard Timing Align any star point with the threaded hole noted for the location of the timing dot (see Figure 6).

Reverse Timing Align any star valley with the threaded hole noted for the location of the timing dot (see Figure 6).

23 Rotate the geroler to align the screw holes and install drive spacer if applicable.

24 Lubricate and install the last one of the three large diameter seals in the groove in the end cap.

25 Install the end cap and seven cap screws.

26 Tighten the cap screws in a criss-cross pattern, to 27-28 Nm [235-250 lb-in].

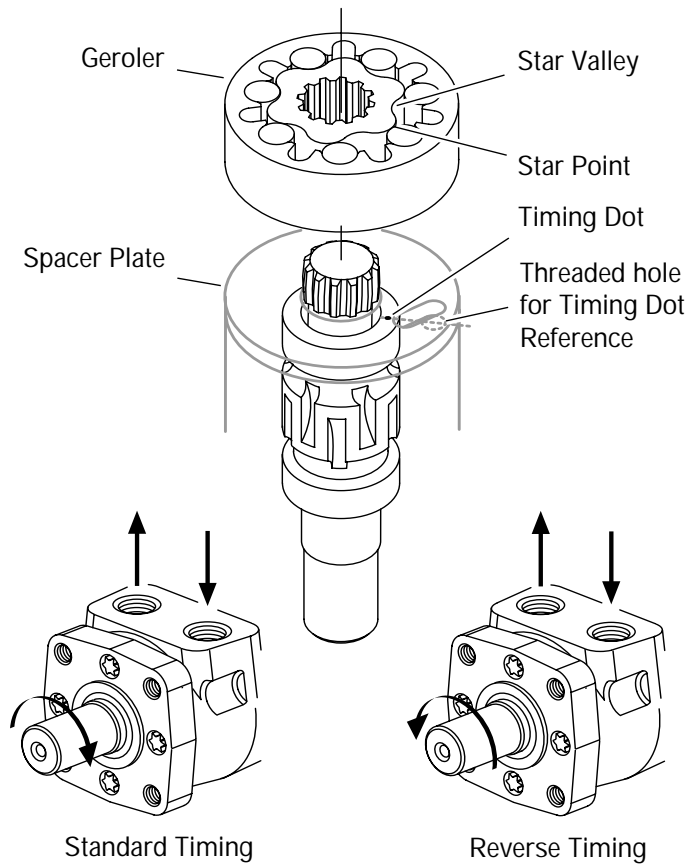
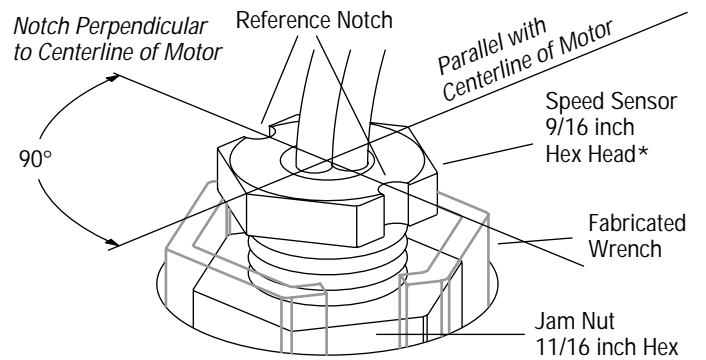

Figure 6

Speed Sensor Installation



*Turn Speed Sensor in to bottom (making sure jam nut is backed off sufficiently), back off 1/4 turn (CCW) and if reference notch(s) is not positioned as shown above continue turning (CCW) to align reference notch 90° off of centerline of motor or perpendicular to motor shaft. Hold speed sensor in this position and tighten jam nut to 8,5 — 14 Nm [75 — 125 lb-in].

General Purpose Motors

How to Order Replacement Parts

Each Order Must Include the Following:

1. Product Number
2. Date Code
3. Part Name
4. Part Number
5. Quantity of Parts

For More Detailed Information Contact Eaton Corp. Hydraulics Division 15151 Highway 5 Eden Prairie, MN 55344.

- Specifications and performance Data, Catalog No. 11-885
- Replacement Part Numbers and Kit Information — Parts Information No. 6-146

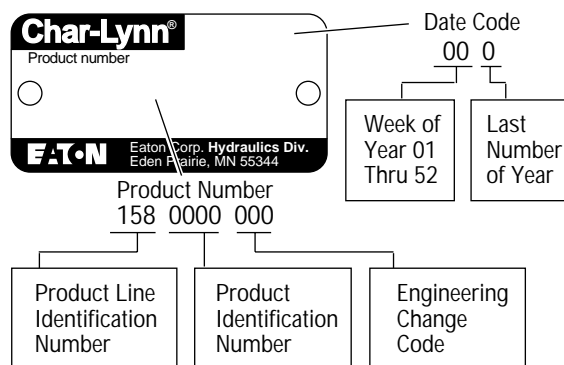

Product Numbers—T Series -001

Add three digit prefix —158—to four digit number from chart for complete product number—Example 158-1068.

Mounting	Shaft	Ports	Displ. cm ³ /r [in ³ /r] Product Number 158-xxxx											
			36 [2.2]	49 [3.0]	66 [4.0]	80 [4.9]	102 [6.2]	131 [8.0]	157 [9.6]	195 [11.9]	244 [14.9]	306 [18.7]	370 [22.6]	
2 Bolt Flange	1 in. Straight w/Woodruff Key	7/8-14 O-ring	158-	—	—	-1537	-1034	-1035	-1538	-1036	-1037	-1038	-1039	-1040
		1/2 NPTF	158-	—	—	-1540	-1026	-1027	-1541	-1028	-1029	-1030	-1031	-1032
		Manifold	158-	—	—	-1543	-1042	-1043	-1544	-1044	-1045	-1046	-1047	-1048
2 Bolt Flange	1 in. SAE 6B Splined	7/8-14 O-ring	158-	—	—	-1552	-1082	-1083	-1553	-1084	-1085	-1086	-1087	-1088
		1/2 NPTF	158-	—	—	-1555	-1074	-1075	-1556	-1076	-1077	-1078	-1079	-1080
		Manifold	158-	—	—	-1558	-1090	-1091	-1559	-1092	-1093	-1094	-1095	-1096
4 Bolt Flange	1 in. Straight w/Woodruff Key	7/8-14 O-ring	158-	—	—	-1570	-1010	-1011	-1571	-1012	-1013	-1014	-1015	-1016
		1/2 NPTF	158-	—	—	-1573	-1002	-1003	-1574	-1004	-1005	-1006	-1007	-1008
		Manifold	158-	—	—	-1576	-1018	-1019	-1577	-1020	-1021	-1022	-1023	-1024
4 Bolt Flange	1 in. SAE 6B Splined	7/8-14 O-ring	158-	—	—	-1579	-1058	-1059	-1580	-1060	-1061	-1062	-1063	-1064
		1/2 NPTF	158-	—	—	-1582	-1050	-1051	-1583	-1052	-1053	-1054	-1055	-1056
		Manifold	158-	—	—	-1585	-1066	-1067	-1586	-1068	-1069	-1070	-1071	-1072

158-1068

Eaton Corporation
Hydraulics Division
15151 Hwy. 5
Eden Prairie, MN 55344
Telephone 612/937-9800
Fax 612/937-7130

Eaton Ltd.
Hydraulics Division
Glenrothes, Fife
Scotland, KY7 4NW
Telephone 01-592-771-771
Fax 01-592-773-184

Eaton GmbH
Hydraulics Products
Am Schimmersfeld 7
40880 Ratingen, Germany
Telephone 02102-406-830
Fax 02102-406-800



Quality System Certified
Products in this catalog are manufactured
in an ISO-9001-certified site.



TENNANT COMPANY
 Technical Publications #15
 701 North Lilac Drive
 P.O. Box 1452
 Minneapolis, MN 55440-9947

POSTAGE WILL BE PAID BY ADDRESSEE

BUSINESS REPLY MAIL
 FIRST CLASS MAIL PERMIT NO. 94 MINNEAPOLIS, MN



NO POSTAGE
 NECESSARY
 IF MAILED
 IN THE
 UNITED STATES

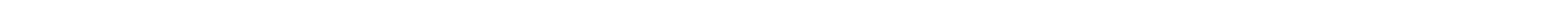
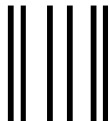

Fold along dotted lines

Tape here

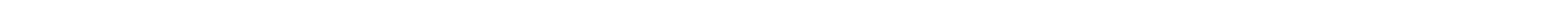



TENNANT COMPANY
 Technical Publications #15
 701 North Lilac Drive
 P.O. Box 1452
 Minneapolis, MN 55440-9947

POSTAGE WILL BE PAID BY ADDRESSEE

BUSINESS REPLY MAIL
 FIRST CLASS MAIL PERMIT NO. 94 MINNEAPOLIS, MN



NO POSTAGE
 NECESSARY
 IF MAILED
 IN THE
 UNITED STATES

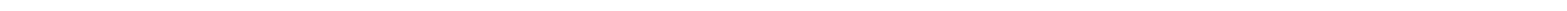
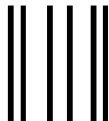

Fold along dotted lines

Tape here

