

# PARTS LIST

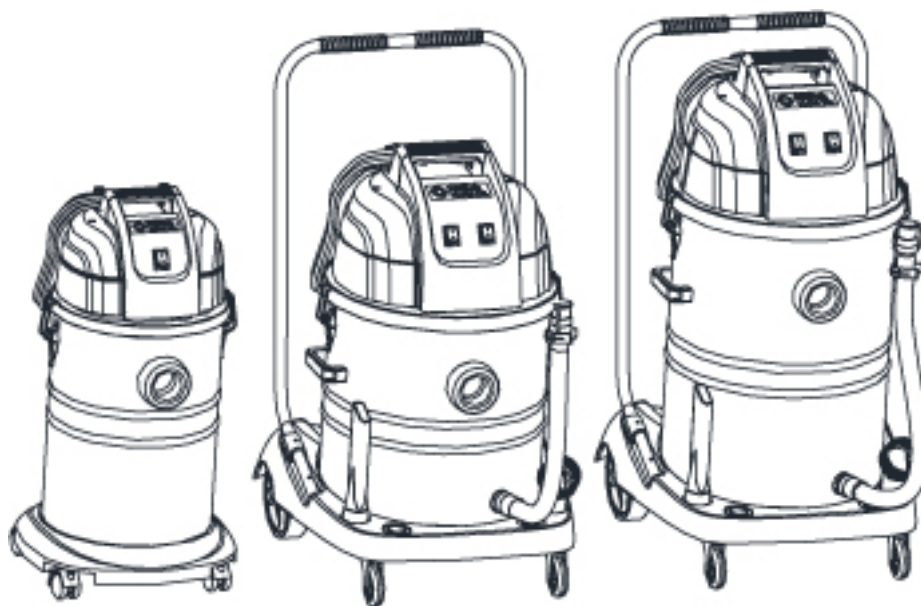

2021.08.02

# TABLE OF CONTENTS

---

Overview .....	1
Accessories .....	3
Wear and tear parts .....	5

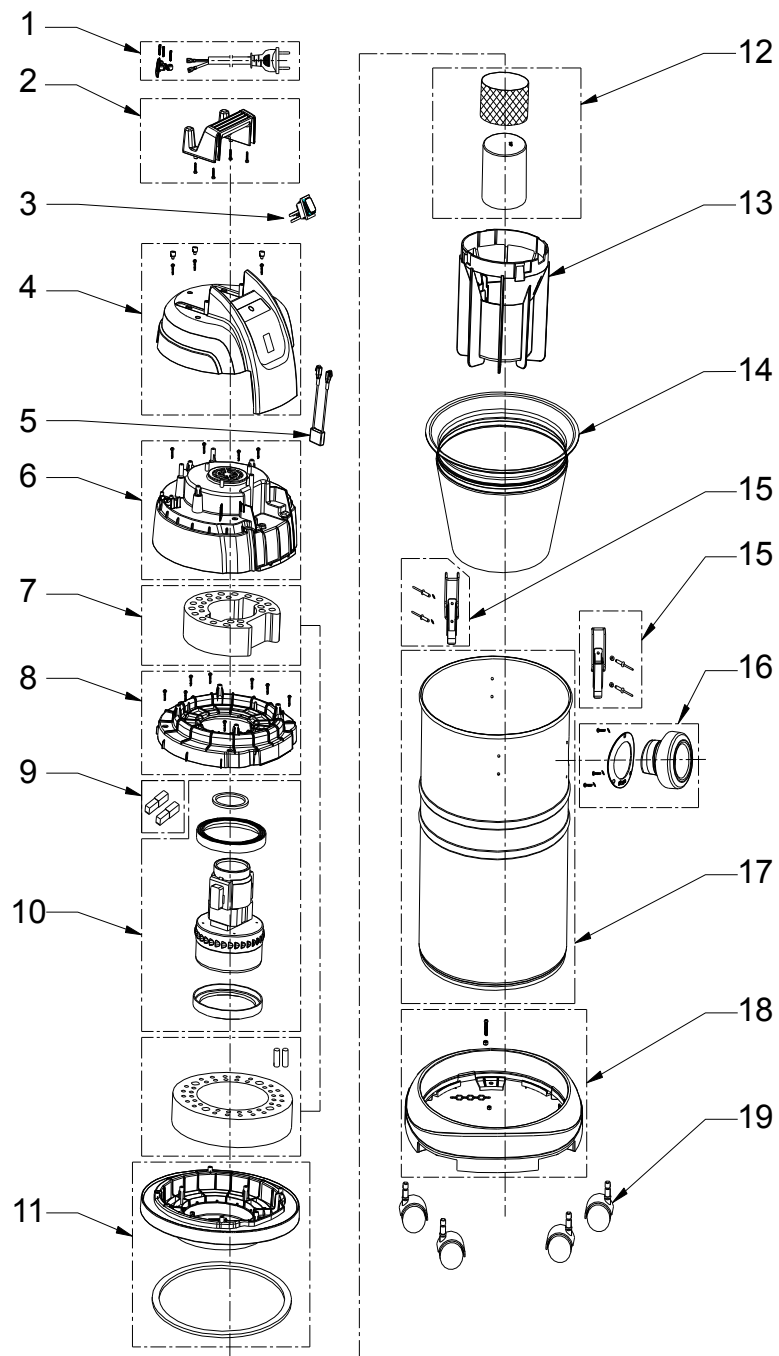

Pos.	Artikel-Nr.	Menge	Variante	Notes
1	VA81996	1	VL100 35L UK POWER CORD+SLEEVE KIT	
1	VA81997	1	VL100 35L EU POWER CORD+SLEEVE KIT	
2	VA81981	1	HANDLE+M4 SCREW KIT	
3	VA81940	1	WATERPROOF SWITCH	
4	VA81982	1	MACHINE HEAD COVER+SCREW KIT	
5	VA80095	1	ELECTRIC CAPACITOR	
6	VA81984	1	MOTOR COVER+SCREW KIT	
7	VA81985	1	MIDDLE SPONGE+DOWN SPONGE KIT	
8	VA81986	1	MOTOR PRESS PLATE+SCREW KIT	
9	ZD89002	1	Kohlebürste	
10	VA81987	1	MOTOR+RUBBER WASHER KIT	
11	VA82026	1	MOTOR MOUNTING+RUBBER BAR KIT	
12	VA81087	1	FLOAT CUP PP+FILTER NET METAL KIT	
13	VA81905	1	FLOAT CUP HOLDER	
14	VA81990	1	Stofffiltereinsatz 35l	
15	VA80734	2	TANK CATCH KIT	
16	VA81991	1	HOSE INLET KIT	
17	VA80064-001	1	VL100 35 LTR STAINLESS STEEL CONTAINER	
18	VA80737	1	Bodenring für Fahrgestell 35L	
19	VA60303	4	FRONT CASTOR GVD15 GV25 GV35 SD18	

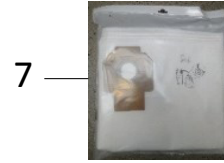

---

Pos.	Artikel-Nr.	Menge	Variante	Notes
1	107407308	1	Saugschlauch kpl. Ø 32 mmx1,9 m	
2	107407309	2	Saugrohr, Edelstahl, Ø 32 mmx0,5 m	
3	VA82025	1	WET FLOOR NOZZLE Ø32 RUBBER STRIP	
4	107407311	1	Hartbodendüse Ø 32 mm, Bürste	
5	107407312	1	Bürstendüse Ø 32 mm	
6	107407334	1	Fugendüse Ø 32 mm	
7	VA82062-P5	1	CLOTH DUST BAG 5PCS FOR 35L VAC.	

---



---

Pos.	Artikel-Nr.	Menge	Variante	Notes
	VA81990	1	Stofffiltereinsatz 35l	
	VA81940	1	WATERPROOF SWITCH	
	VA60303	4	FRONT CASTOR GVD15 GV25 GV35 SD18	
	VA80734	2	TANK CATCH KIT	
	VA82062-P5	1	CLOTH DUST BAG 5PCS FOR 35L VAC.	
	ZD89002	1	Kohlebürste	



