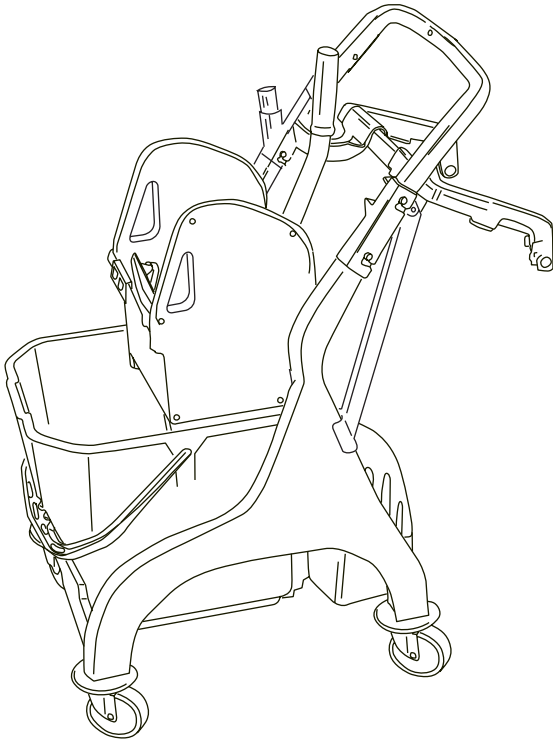
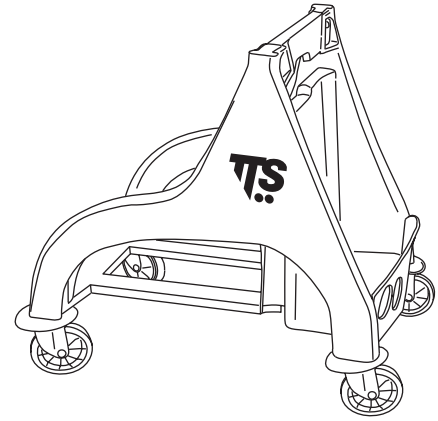
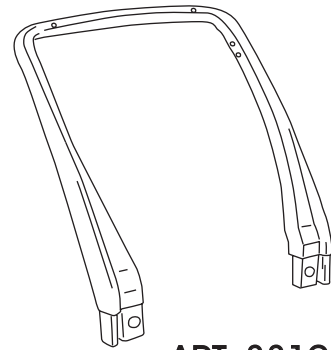
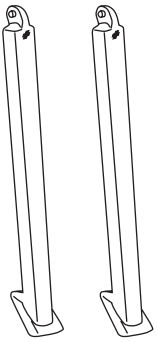
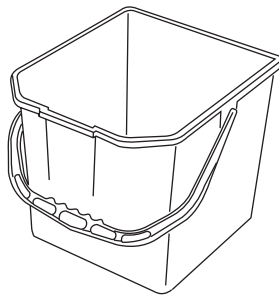
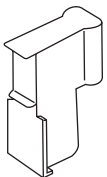
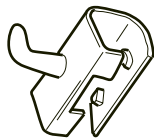
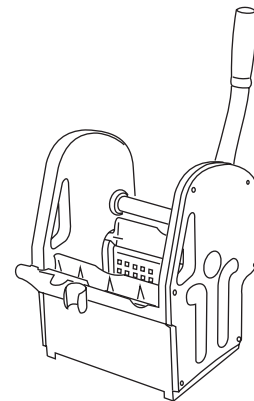
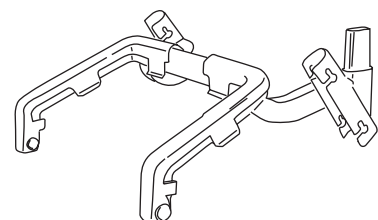

T.S.**NICK
Plus****ART. 00006509****ART. L030049****ART. 3310****ART. 3315****ART. 000B3500****ART. S070030****ART. S070050****ART. 3724****ART. S070100****T.S.**ASSEMBLY INSTRUCTION
SCHEDA DI MONTAGGIO

REV.1

DATE - DATA
01/12/04

CODE - CODICE

00006509APPROVAL
APPROVAZIONE

PRODUCT - PRODOTTO

NICK PLUS 10

