

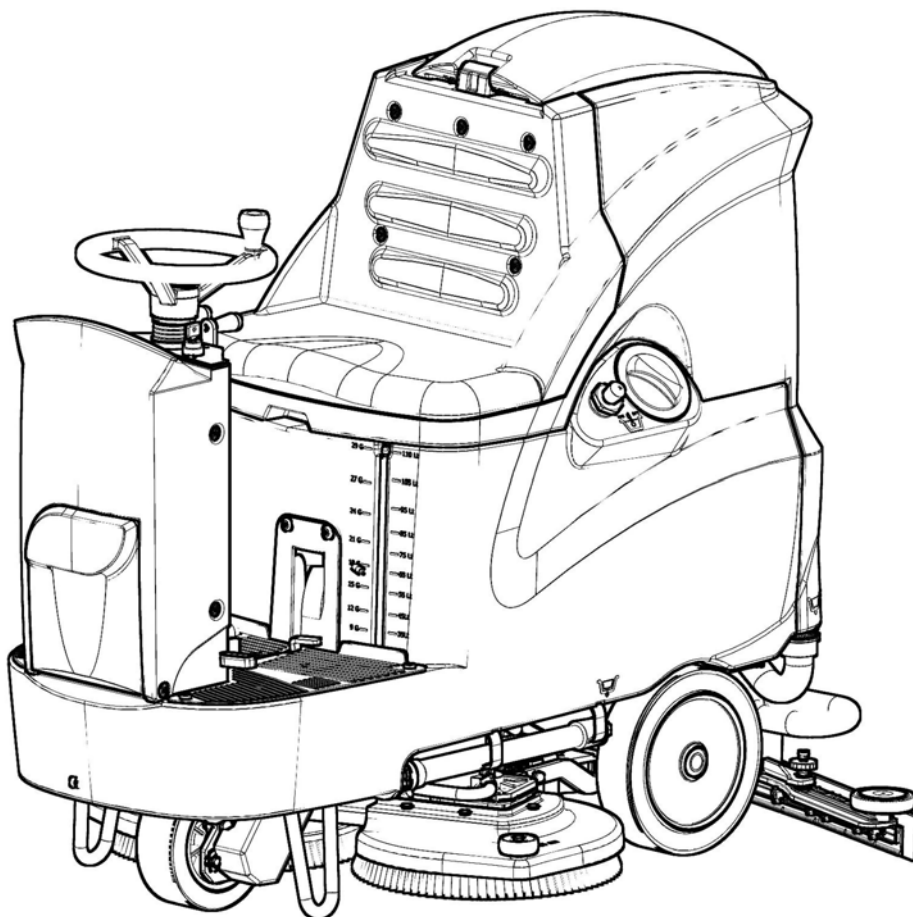

WORKSHOP HANDBOOK

MR



Version: **AA**
Date: **July 24, 2014**
Document Number: **10049552**

ATTENTION

This document is valid starting from serial number:

214005544

Contents

I	Product Introduction	5
1	Serial Number and Technical Support	6
1.1	The Serial Tag	6
1.2	Serial Tag location	6
2	Main Technical Features	7
II	Anomalies Resolution Guide	9
3	Trouble-shooting for the most common anomalies	10
3.1	Electrical system: what to do if.	10
3.2	Mechanical scrubbing system: what to do if.	12
3.3	Drying system: what to do if.	14
3.4	Frame and traction system: what to do if.	16
3.5	Solution delivery system: what to do if.	17
4	Disassembling Procedures	18
4.1	Electrical Installation	19
4.2	Mechanical Friction System	24
4.3	Drying System	28
4.4	Frame and Traction System	33
4.5	Solution Delivery System	37
III	Machine Description	40
5	Electrical System	41
5.1	Structure	41
5.2	Description	41
5.3	Location of Electrical Components	42
5.4	Adjustments	47
5.5	Maintenance and Checks	50
5.6	Alarm Table - Traction Card	51
5.7	Menu tables - Traction Card	52
5.8	Technical Features	56
5.9	Recommended Spare Parts	56

6	Mechanical Rubbing System	57
6.1	Description:	57
6.2	Adjustments	59
6.3	Maintenance and checks	60
6.4	Technical Features	62
6.5	Consumable Spare Parts	62
6.6	Recommended Spare Parts	64
7	Drying System	65
7.1	Structure	65
7.2	Description	65
7.3	Adjustments	66
7.4	Maintenance and Checks	67
7.5	Technical Features	70
7.6	Consumable Spare Parts	70
7.7	Recommended Spare Parts	70
8	Machine Frame and Traction System	71
8.1	Structure	71
8.2	Description	71
8.3	Adjustments	72
8.4	Maintenance and Checks	73
8.5	Technical Features	75
8.6	Consumable Spare Parts	75
8.7	Recommended Spare Parts	75
9	Cleaning Solution Supply System	76
9.1	Structure	76
9.2	Description:	76
9.3	Maintenance and Checks	77
9.4	Technical Features	79
9.5	Recommended Spare Parts	79
IV	Accessories and Add-On	80
10	Accessories	81
10.1	Accessories List	81
10.2	Blinking Kit - 221648	81
10.3	Onboard Charger Kit - 219613	83
10.4	Fast Filling Kit - 219464	84
10.5	3 Stages Vacuum Motor Kit - 219646	84
10.6	Splashguard Kit w/rubbers, MR65(221973), MR75(221974), MR85(221975)	85
10.7	Plastic squeegee Kit, MR65-75(219381), MR85-100(219382)	86
10.8	Consumable Spare Parts	87
10.9	Recommended Spare Parts	87

Part I

Product Introduction

Chapter 1

Serial Number and Technical Support

1.1 The Serial Tag

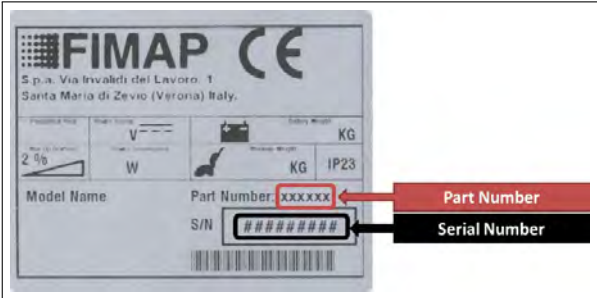

1.2 Serial Tag location

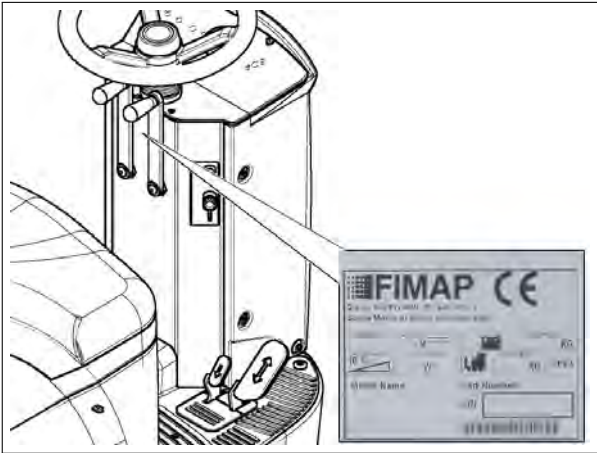

The serial number plate is located on the steering column, next to the brush head and squeegee lifting levers.

The Serial Number is an extremely important information which has to be provided each time a Technical Support is required or is necessary to buy spare parts or accessories. The serial number is the only way to identify the machine by model, production date type equipments in general.

Chapter 2

Main Technical Features

Technical Data

TECHNICAL DESCRIPTION	U/M	MR				
		60	65	75	85	100
Working width	mm	610	650	750	850	1010
Working capacity, up to	$\frac{m^2}{h}$	3660	3900	4500	5100	6000
Steering Diameter	mm	1910	1910	1910	1910	1910
Maximum Ramp Gradient	%	10	10	10	10	10
Total Power	W	1160	1610	1610	1610	1910
Machine Length	mm	1495	1495	1495	1495	1495
Machine Height	mm	1320	1320	1320	1320	1320
Machine Height <i>with optional blinking kit</i>	mm	1390	1390	1390	1390	1390
Machine Width <i>(with squeegee)</i>	mm	800	990	990	1105	1105
Machine Width <i>(without squeegee)</i>	mm	680	680	780	860	1030
Wheel Base	mm	820	820	820	820	820
Wheel Track	mm	610	610	610	610	610
Footrest height from the ground	mm	405	405	405	405	405
Seat height from the footrest	mm	460	460	460	460	460
Handlebar distance from the back seat	mm	480	480	480	480	480
Sound pressure level <i>(ISO 11201)</i>	LpA dB (A)	-	-	-	-	-
Hand vibration level <i>(ISO 5349)</i>	$\frac{m}{s^2}$	-	-	-	-	-
Body vibration level <i>(ISO 2631)</i>	$\frac{m}{s^2}$	-	-	-	-	-

Weights and Pressures¹

TECHNICAL DESCRIPTION	U/M	MR				
		60	65	75	85	100
Machine Weight <i>(empty and without batteries)</i>	kg	210	213	213	213	230
Gross Weight of the machine in work conditions <i>(machine + batteries + water + operator)</i>	kg	530	535	535	535	555

TECHNICAL DESCRIPTION	U/M	MR
Weight front wheel	kg	≤ 146.0
Front wheel pressure	$\frac{kg}{cm^2}$	≤ 7.4
Weight rear right wheel	kg	≤ 204.0
Rear right wheel pressure	$\frac{kg}{cm^2}$	≤ 11.9
Weight rear left wheel	kg	≤ 202.0
Rear left wheel pressure	$\frac{kg}{cm^2}$	≤ 11.2

¹Weight and Pressures depends on how much water there is in the tanks and on what type of battery the machine fits.

Part II

Anomalies Resolution Guide

Chapter 3

Trouble-shooting for the most common anomalies

3.1 Electrical system: what to do if...

The machine doesn't switch on	
1. The key is in position 0	⇒ <i>Rotate the key in position I.</i>
2. The key switch is not properly connected	⇒ <i>Restore the proper connections.</i>
3. The key switch doesn't work	⇒ <i>Replace the key switch (see section 4.1.1 at page 19).</i>
4. The machine is not supplied	⇒ <i>Check the proper section (see section 3.1 at page 10).</i>
5. The machine is powered properly	⇒ <i>Check the charge level of the batteries and if necessary perform a recharge cycle or replace them.</i>

The machine has a very limited working autonomy	
1. The BDI (Battery Discharge Indicator) is not properly adjusted	⇒ <i>Verify the type of battery used on the machine and adjust properly the BDI.</i>
2. Batteries have been working for several cycles	⇒ <i>Replace the batteries.</i>

The batteries don't work properly

- | | | |
|--|---|---|
| 1. The batteries are not properly connected | ⇒ | <i>Restore the proper battery connections.</i> |
| 2. The batteries are discharged | ⇒ | <i>Perform a complete charge cycle.</i> |
| 3. Battery terminals are oxidized | ⇒ | <i>Disconnect the batteries, clean the batteries terminals and reconnect properly the batteries protecting the connections with grease.</i> |
| 4. With the machine in working conditions one battery has a voltage lower (difference higher than 2 V) than the other ones | ⇒ | <i>Replace the battery with lower voltage.</i> |
| 5. The power wires are damaged | ⇒ | <i>Replace the damaged wires.</i> |
| 6. The battery charger doesn't work | ⇒ | <i>Check the proper section (see section 3.1 at page 11).</i> |
-

The battery charger doesn't work

- | | | |
|---|---|--|
| 1. The battery charger is not connected to the power supply | ⇒ | <i>Connect the charger to a supplied electric socket.</i> |
| 2. The battery charger is not connected to the batteries | ⇒ | <i>Connect the charger to the batteries.</i> |
| 3. The battery charger is not properly adjusted | ⇒ | <i>Verify the type of battery in use and adjust the battery charger properly following the instructions (see section 5.4.4 at page 49).</i> |
| 4. The battery charger has one or more lights (or LEDs) blinking continuously | ⇒ | <i>The battery charger is in error conditions, verify the alarm tables and solve the issue by following the related instructions (see section 5.4.4 at page 49).</i> |
| 5. The battery charger is properly connected but it doesn't switch on | ⇒ | <i>Replace the battery charger.</i> |
-

3.2 Mechanical scrubbing system: what to do if...

The machine doesn't clean well

- | | | |
|--|---|---|
| 1. The machine is switched off | ⇒ | <i>Switch on the machine.</i> |
| 2. The machine doesn't switch on | ⇒ | <i>Refer to the proper section (see section 3.1 at page 10).</i> |
| 3. The machine is not in working condition | ⇒ | <i>Switch on the machine.
Lower the scrubbing base.
Press the traction pedal.</i> |
| 4. The brush doesn't rotate in the correct direction | ⇒ | <i>Check the motor connections.</i> |
| 5. The microswitch of the traction pedal doesn't work | ⇒ | <i>Replace the microswitch (see section 4.1.9 at page 21).</i> |
| 6. The brush is not properly engaged | ⇒ | <i>Release and engage properly the brush.</i> |
| 7. The brush deck is not properly adjusted | ⇒ | <i>Check and proceed a proper adjustment of the brush deck following the instructions (see section 6.2.2 at page 59).</i> |
| 8. The machine does not clean properly | ⇒ | <i>Check/use the brush deck extra pressure Lever (only on MR 65, 75, 85).</i> |
| 9. The solution flow rate is not correct or not enough | ⇒ | <i>Refer to the proper section (see section 3.5 at page 17).</i> |
-

The brush motor does not work properly

- | | | |
|---|---|--|
| 1. The brush motor is switched off | ⇒ | <i>Switch on the brush motor.</i> |
| 2. The brush motor is not supplied | ⇒ | <i>Verify the motor connections.</i> |
| 3. The microswitch of the scrubbing base lifting lever doesn't work | ⇒ | <i>Replace the microswitch (see section 4.1.8 at page 21).</i> |
| 4. The carbon brushes are worn out | ⇒ | <i>Replace the carbon brushes (see section 6.3.3 at page 60).</i> |
| 5. The brush motor is not powered although the microswitches are functioning properly | ⇒ | <i>Verify the electric wiring and the proper functioning of the Relay card and if necessary replace it (see section 4.1.5 at page 20).</i> |
| 6. The brush motor is supplied but it doesn't work | ⇒ | <i>Replace the motor (see section 4.2.3 at page 24) (see section 4.2.5 at page 25).</i> |
-

The brush deck doesn't move

- | | | |
|--|---|--|
| 1. The brush deck Lever doesn't move | ⇒ | <i>Check that there are no mechanical obstacles to the movement of the lever.</i> |
| 2. The lever moves but the brush deck doesn't move | ⇒ | <i>Check that the lifting cable runs in its sheath and the chain is free to move. Check that the brush deck lifting arms are free to move.</i> |
| 3. The brush deck is lowered but it doesn't touch the ground | ⇒ | <i>Check the settings of the lifting cable.</i> |
| 4. The base does not lift properly | ⇒ | <i>Check for proper operation of the brush deck extra pressure Lever (only on MR 65, 75, 85).</i> |
-

3.3 Drying system: what to do if...

The machine doesn't dry well

1.	The machine is switched off	⇒	Switch on the machine.
2.	The machine doesn't switch on	⇒	Refer to the proper section (see section 3.1 at page 10).
3.	The machine is not in working condition	⇒	Switch on the machine. Lower the squeegee to the ground.
4.	The recovery tank is full	⇒	Empty the recovery tank following the proper procedure.
5.	The squeegee is lifted up from the floor	⇒	Lower down the squeegee.
6.	The squeegee rubber blades are worn out or broken	⇒	Rotate or replace the squeegee rubber blades (see section 7.4.1 at page 67).
7.	The squeegee is not properly adjusted	⇒	Adjust the squeegee properly following the proper procedure (see section 7.3.1 at page 66).
8.	The squeegee vacuum chamber is stuck or dirty	⇒	Clean the squeegee vacuum chamber.
9.	The squeegee adapter is stuck or dirty	⇒	Clean the squeegee adapter.
10.	The vacuum hose is stuck or broken	⇒	Clean or replace the vacuum hose.
11.	The vacuum hose is not properly fitted in	⇒	Connect the vacuum hose properly.
12.	The vacuum filter is dirty or stuck	⇒	Disassemble and clean the vacuum filter (see section 7.4.5 at page 68).
13.	The vacuum cover is not well positioned	⇒	Position properly the vacuum cover.
14.	The vacuum cover gasket doesn't adhere properly	⇒	Replace the vacuum cover gasket.

The vacuum motor doesn't work properly

- | | | |
|---|---|--|
| 1. The vacuum motor is switched off | ⇒ | Switch on the vacuum motor. |
| 2. The vacuum motor is not powered properly | ⇒ | Check the power connections on the vacuum motor. |
| 3. The microswitch on the squeegee lifting lever doesn't work | ⇒ | Replace the microswitch (see section 4.1.8 at page 21). |
| 4. The vacuum motor carbon brushes are worn out | ⇒ | Replace the vacuum motor carbon brushes (see section 7.4.7 at page 69). |
| 5. The vacuum motor is not powered although the control microswitch is functioning properly | ⇒ | Verify the electric wiring and the proper functioning of the Relay card and if necessary replace it (see section 4.1.5 at page 20). |
| 6. The vacuum motor is supplied but it doesn't work | ⇒ | Replace the vacuum motor (see section 4.3.11 at page 32). |
-

The squeegee doesn't move

- | | | |
|--|---|---|
| 1. The squeegee Lever doesn't move | ⇒ | Check that there are no mechanical obstacles to the movement of the lever. |
| 2. The lever moves but the squeegee doesn't move | ⇒ | Check that the lifting cable runs in its sheath and the chain and the rear lever is free to move. |
| 3. The squeegee is lowered but it doesn't touch the ground | ⇒ | Check the settings of the lifting cable. |
-

3.4 Frame and traction system: what to do if...

The traction motor doesn't work properly

1.	The machine is switched off	⇒	Switch on the machine.
2.	The machine doesn't switch on	⇒	Check the proper section (see section 3.1 at page 10).
3.	The batteries are discharged	⇒	Connect the battery charger and perform a complete charge cycle.
4.	The operator is not sitting on the seat	⇒	The operator must sit on the seat.
5.	The operator is sitting on the seat	⇒	Check and / or replace the deadman seat microswitch (see section 4.1.7 at page 20).
6.	The pedal is not pressed	⇒	Press the pedal depending on the required speed.
7.	The pedal is pressed	⇒	Check and / or replace the potentiometer or the microswitch connected to the pedal (see section 4.1.10 at page 22) (see section 4.1.9 at page 21).
8.	The traction motor is not supplied	⇒	Check the power connections of the motor.
9.	The traction motor carbon brushes are worn out	⇒	Replace the carbon brushes (see section 8.4.4 at page 74).
10.	The traction motor is supplied but it doesn't work	⇒	Replace the motor (see section 4.4.5 at page 35).
11.	The parking brake doesn't disengage	⇒	Check the mechanical components of the parking brake.
12.	The parking brake disengages but the machine does not proceed; The red LED on the dashboard stays lit	⇒	Check and/or replace electrical wiring or the parking brake microswitch (see section 4.1.13 at page 23).
13.	The LED of the traction card blinks intermittently	⇒	Check the number of blinks, identify the type of alarm solve the related issue by following the proper instructions (see section 5.6 at page 51).
14.	The display on the traction card programmer shows an alarm message	⇒	Check which alarm message is shown and solve the related issue by following the proper instructions (see section 5.6 at page 51).
15.	The card drive is not powered	⇒	Check the electrical wiring and the related safety relay.

3.5 Solution delivery system: what to do if...

The delivered solution is not correct or not enough

1.	The machine is switched off	⇒	<i>Switch on the machine.</i>
2.	The machine doesn't switch on	⇒	<i>Refer to the proper section (see section 3.1 at page 10).</i>
3.	The solution tank is empty	⇒	<i>Fill up the solution tank.</i>
4.	The water valve for the solution flow adjustment is completely closed	⇒	<i>Open the water valve to the desired position.</i>
5.	The hose that connects the solution tank to the filter is stuck	⇒	<i>Clean the hose.</i>
6.	The solution filter is stuck	⇒	<i>Clean the solution filter.</i>
7.	The brush deck is not in working conditions	⇒	<i>Lower the brush deck to the floor. Press the traction pedal to start the washing.</i>
8.	The solenoid valve doesn't work	⇒	<i>Check the connections of the solenoid valve and the proper functioning of the Relay Card and the control microswitches and eventually replace the non-functioning components (see section 4.5.4 at page 39).</i>
9.	The detergent is not suitable for the type of dirt	⇒	<i>Replace the detergent with a proper one.</i>

Chapter 4

Disassembling Procedures

WARNING: BEFORE TO PERFORM ANY OPERATION DESCRIBED BELOW VERIFY THAT THE MACHINE TANKS ARE COMPLETELY EMPTY, THE MACHINE HAS TO BE TURNED OFF. DISCONNECT THE BATTERIES AND REMOVE THEM FROM THE MACHINE. AT LAST, VERIFY THAT THE PARKING BRAKE IS ENGAGED AND THE MACHINE IS IN A TOTALLY SAFE CONDITION.

4.1 Electrical Installation

4.1.1 Key Switch

- Put the machine in safe conditions.
- Remove the screws that secure the front carter to the steering column (see fig. 4.1.1-1).
- Unscrew the nuts securing the electrical system support plate and remove it (see fig. 4.1.1-2).
- Disconnect the wires connected to the key switch.
- Unscrew the ring nut that secures the key switch to the steering column (see fig. 4.1.1-3).
- Remove the key switch.
- Proceed at reverse to refit the part.

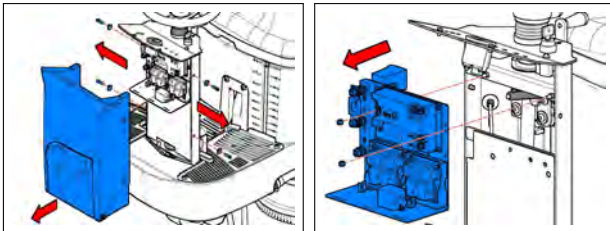

4.1.1-1

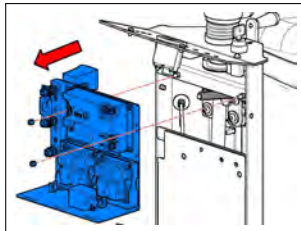

4.1.1-2

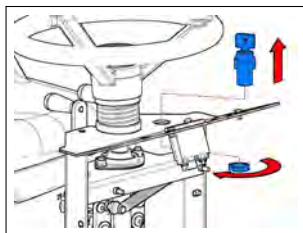

4.1.1-3

4.1.2 Hourmeter

- Put the machine in safe conditions.
- Remove the screws that secure the front carter to the steering column (see fig. 4.1.2-4).

- Disconnect the connector of the hourmeter.
- Unscrew the retaining bolts that secure the hourmeter to the machine dashboard and remove it (see fig. 4.1.2-5).
- Proceed at reverse to refit the part.

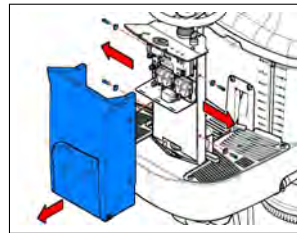

4.1.2-4

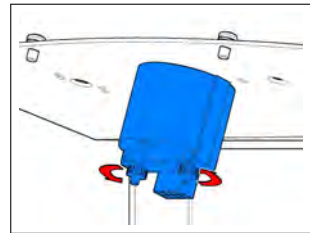

4.1.2-5

4.1.3 Buzzer

- Put the machine in safe conditions.
- Remove the screws that secure the front carter to the steering column.
- Unscrew the nuts securing the electrical system support plate and remove it (see fig. 4.1.3-6).
- Disconnect the buzzer cables.
- Loosen the screws that secure the buzzer to the support bracket and remove it (see fig. 4.1.3-7).
- Proceed at reverse to refit the part.

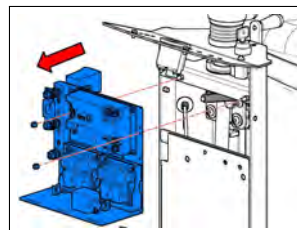

4.1.3-6

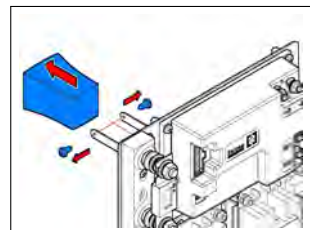

4.1.3-7

4.1.4 Traction card

- Put the machine in safe conditions.
- Remove the screws that secure the front carter to the steering column (see fig. 4.1.4-8).
- Disconnect the power cables and control cables traction motor.
- Disconnect the connector.
- Remove the screws securing the traction card to the machine and remove it (see fig. 4.1.4-9).
- Proceed at reverse to refit the part.

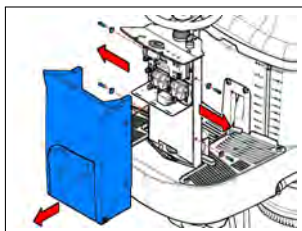

4.1.4-8

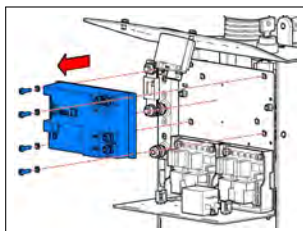

4.1.4-9

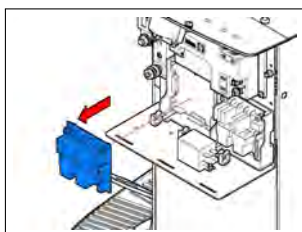

4.1.4-10

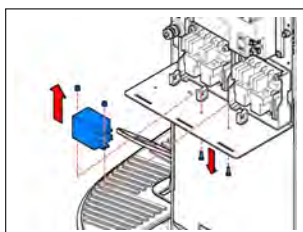

4.1.4-11

4.1.5 Relay card

- Put the machine in safe conditions.
- Remove the screws that secure the front carter to the steering column (see fig. 4.1.4-8).
- Disconnect the power cord of the card and the power cord of the brush motor and vacuum motor.
- Disconnect all the connectors of the relay card.

- Unhook the card from its holder to remove it (see fig. 4.1.4-10).
- Proceed at reverse to refit the part.

4.1.6 Traction relay

- Put the machine in safe conditions.
- Remove the screws that secure the front carter to the steering column (see fig. 4.1.4-8).
- Disconnect the wires connected to the relay.
- To remove the relay, unscrew the two screws and remove the device (see fig. 4.1.4-11).
- Proceed at reverse to refit the part.

4.1.7 Dead Man Switch (Seat microswitch)

- Put the machine in safe conditions.
- Remove the seat from the machine (see section 4.4.11 at page 37).
- Remove the switch connecting joints.
- Remove the dead man Switch (ATTENTION: The dead man Switch is glued to the lubritene spacer).
- Proceed at reverse to refit the part.

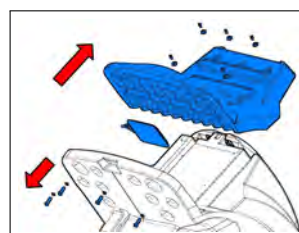

4.1.7-12

4.1.8 Lever microswitch

- Put the machine in safe conditions.
- Remove the screws that secure the front carter to the steering column.
- Unscrew the nuts securing the electrical system support plate and remove it.
- Remove the bottom panel of the electrical system (see fig. 4.1.8-13).
- Unhook the lever return spring (see fig. 4.1.8-14).
- Remove the brush base and squeegee lifting levers (see fig. 4.1.8-15).
- Remove the lever lifting plates (see fig. 4.1.8-16).
- Disconnect the wires connected to the microswitch.
- To remove the microswitch, unscrew the two screws and remove the device (see fig. 4.1.8-17).
- Proceed at reverse to refit the part.

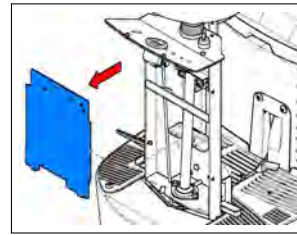

4.1.8-13

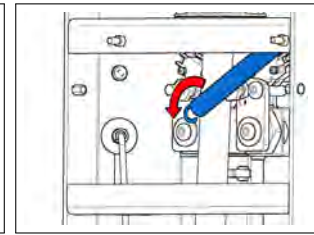

4.1.8-14

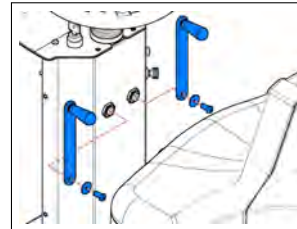

4.1.8-15

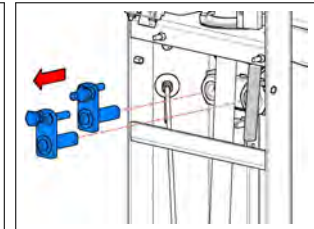

4.1.8-16

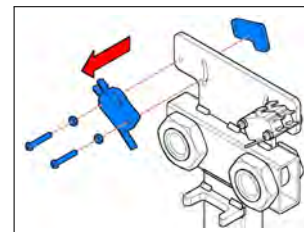

4.1.8-17

4.1.9 Forward pedal microswitch

- Put the machine in safe conditions.
- Remove the screws that secure the right footrest and remove it (see fig. 4.1.9-18).
- Disconnect the head register connected to the traction pedal and to the threaded rod (see fig. 4.1.9-19).
- Disconnect the wires connected to microswitches on the supporting plate potentiometer.
- Unscrew the nuts securing the support plate potentiometer to the machine (see fig. 4.1.9-20).
- Unscrew the two fixing screws and remove the microswitch (see fig. 4.1.9-21).
- Proceed at reverse to refit the part.

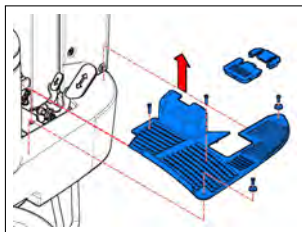

4.1.9-18

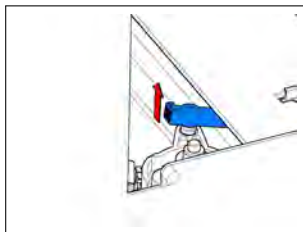

4.1.9-19

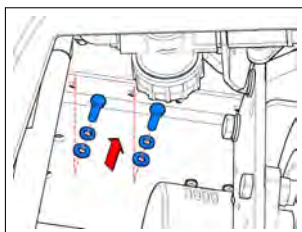

4.1.9-20

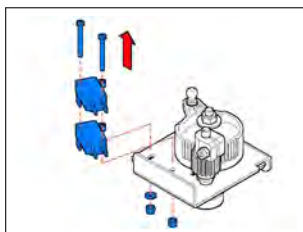

4.1.9-21

4.1.10 Potentiometer

- Put the machine in safe conditions.
- Remove the pedal covers.
- Remove the screws that secure the right footrest and remove it.
- Disconnect the head register connected to the traction pedal and to the threaded rod.
- Disconnect the wires connected to microswitches on the supporting plate potentiometer.
- Unscrew the nuts securing the support plate potentiometer to the machine (see fig. 4.1.10-22).
- Unscrew the fixing screw to remove the pinion from the shaft of the potentiometer together with the toothed cam (see fig. 4.1.10-23).
- Unscrew the locking ring of the potentiometer to the support plate (see fig. 4.1.10-24).
- Cut the wires of the potentiometer to replace it.

- Proceed at reverse to refit the part (ATTENTION: The potentiometer wires previously cut must be restored).

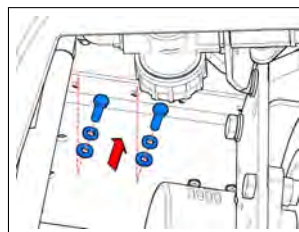

4.1.10-22

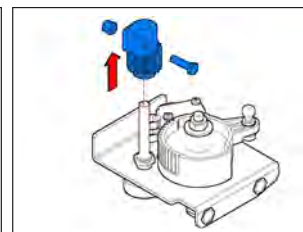

4.1.10-23

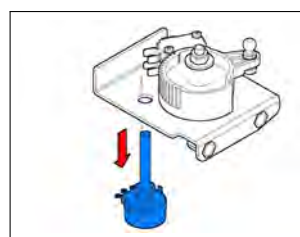

4.1.10-24

4.1.11 Backward pedal microswitch

- Put the machine in safe conditions.
- Remove the screws that secure the right footrest and remove it (see fig. 4.1.11-25).
- Disconnect the wires connected to microswitches.
- Unscrew the screws fixing the microswitch to the plate on the frame and remove it (see fig. 4.1.11-26).
- Proceed at reverse to refit the part.

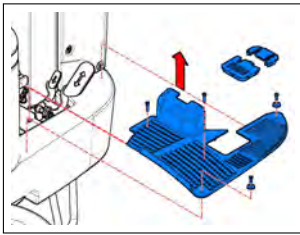

4.1.11-25

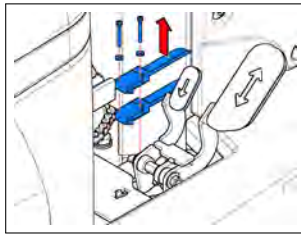

4.1.11-26

4.1.12 Extra pressure microswitch

- Put the machine in safe conditions.
- Unscrew the screws that secure both footrests and remove them (see fig. 4.1.11-25) (see fig. 4.1.12-27).
- Unscrew the screws fixing the extra pressure carter and remove it (see fig. 4.1.12-28).
- Unscrew the screws fixing the microswitch to its support plate and remove it (see fig. 4.1.12-29) (see fig. 4.1.12-30).
- Proceed at reverse to refit the part.

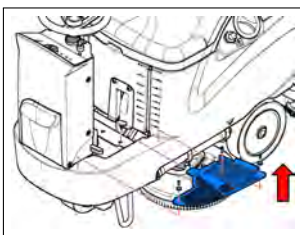

4.1.12-27

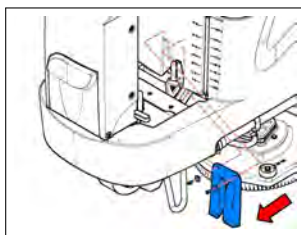

4.1.12-28

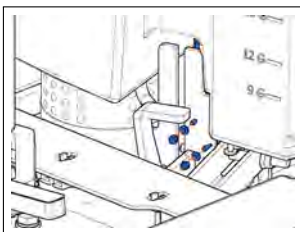

4.1.12-29

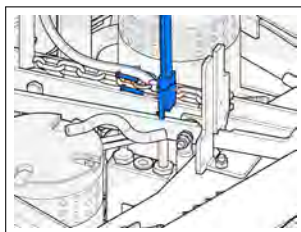

4.1.12-30

4.1.13 Parking brake microswitch

- Put the machine in safe conditions.
- Remove the screws that secure the right footrest and remove it (see fig. 4.1.13-31).
- Remove the screws that secure the front carter to the steering column (see fig. 4.1.13-32).
- Remove the bottom panel of the electrical system (see fig. 4.1.13-33).
- Disconnect the wires connected to microswitches.
- Unscrew the screws fixing the microswitch and remove it (see fig. 4.1.13-34).
- Proceed at reverse to refit the part.

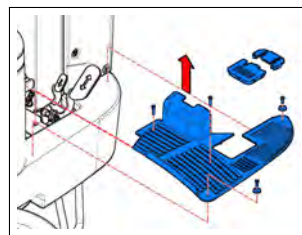

4.1.13-31

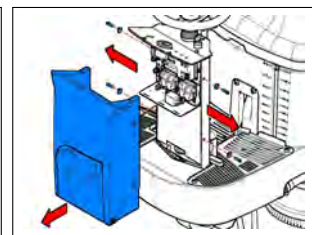

4.1.13-32

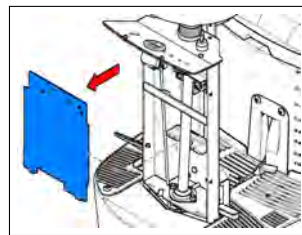

4.1.13-33

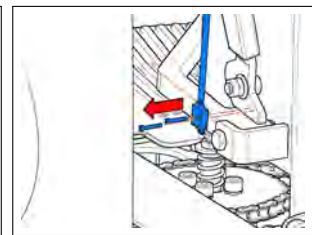

4.1.13-34

4.2 Mechanical Friction System

4.2.1 Brush Deck Assembly

- Release the brush/es from the Brush Deck.
- Put the machine in safe conditions.
- Lower the brush deck to the floor.
- Remove the lifting arms from the brush deck (see section 4.2.7 at page 26).
- Remove the screws that secure the right footrest and remove it.
- Disconnect the electrical connector of the brush/es motor/s.
- Disconnect the electrical connector of the solenoid valve.
- Disconnect the solution supply hose.
- Disconnect the lift chain from the brush plate.
- Lift the front wheel in order to lift the front part of the machine of about 20cm (see fig. 4.2.1-35).
- Pull off the brush deck sideways to the machine (see fig. 4.2.1-36).
- Proceed at reverse to refit the part.

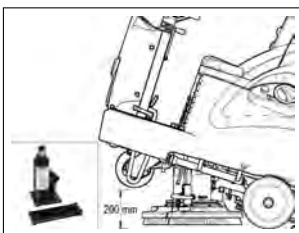

4.2.1-35

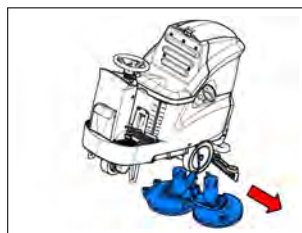

4.2.1-36

4.2.2 Brush Coupling Flange

- Put the machine in safe conditions.
- Disassemble the Brush Deck from the machine (see section 4.2.1 at page 24).
- Unscrew the Coupling Flange rotating it in the same direction as the brush in standard working conditions (see fig. 4.2.2-37).
- Remove the brush retaining spring (see fig. 4.2.2-38).
- Proceed at reverse to refit the part.
- Before to refit the part lubricate the thread in order to prevent blockings because of dirt or oxide.

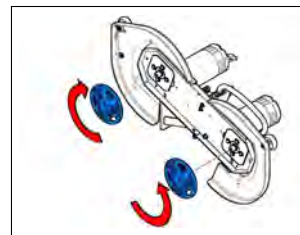

4.2.2-37

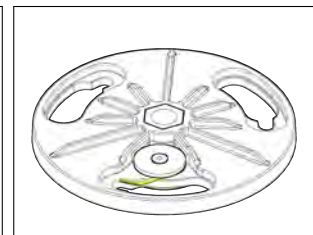

4.2.2-38

4.2.3 Motor MR 60, MR 65, MR 75, MR 85

- Put the machine in safe conditions.
- Disassemble the Brush Deck from the machine (see section 4.2.1 at page 24).
- Unscrew the Coupling Flange from the motor shaft (see section 4.2.2 at page 24).
- Unscrew the screws fixing the motor/s to the brush deck and remove the motor/s (see fig. 4.2.3-39) (see fig. 4.2.3-40).
- Proceed at reverse to refit the part (Apply thread lock liquid on the screws fixing the motor to the brush deck, before the assembling).

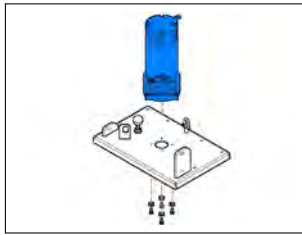

4.2.3-39

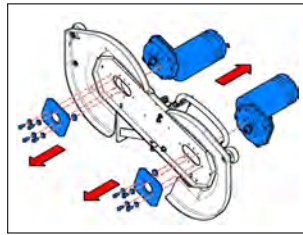

4.2.3-40

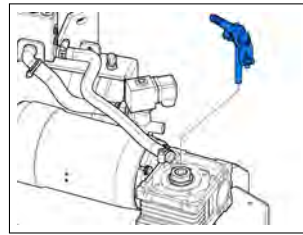

4.2.4-41

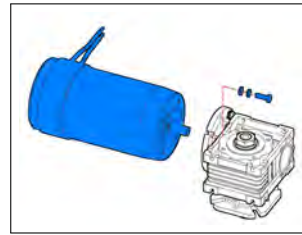

4.2.4-42

4.2.4 Reduction gear MR 100

- Put the machine in safe conditions.
- Disassemble the brush Deck from the machine (see section 4.2.1 at page 24).
- Unscrew the Coupling Flange from the motor shaft (see section 4.2.2 at page 24).
- Unscrew the screws fixing the water fitting support (see fig. 4.2.4-41).
- Unscrew the screws fixing the reduction gear to the motor (see fig. 4.2.4-42).
- Unscrew the screws fixing the reduction gear to the brush deck (see fig. 4.2.4-43).
- Proceed at reverse to refit the part (Apply thread lock liquid on the screws fixing the reduction gear to the brush deck, before the assembling).

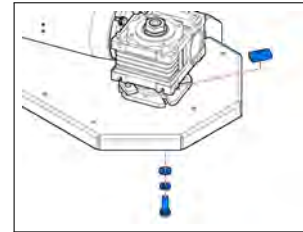

4.2.4-43

4.2.5 Motor MR 100

- Put the machine in safe conditions.
- Disassemble the brush Deck from the machine (see section 4.2.1 at page 24).
- Unscrew the Coupling Flange from the reduction gear shaft (see section 4.2.2 at page 24).
- Disassemble the reduction gear (see section 4.2.4 at page 25).
- Remove the motor paying attention to the key on the motor shaft.
- Proceed at reverse to refit the part (Apply thread lock liquid on the screws fixing the motor to the brush deck, before the assembling).

4.2.6 Brush deck body

- Put the machine in safe conditions.
- Disassemble the brush Deck from the machine (see section 4.2.1 at page 24).
- Unscrew the Coupling Flange from the reduction gear shaft (see section 4.2.2 at page 24).
- Remove the motor/s (see section 4.2.3 at page 24) (see section 4.2.5 at page 25).
- Remove the solenoid valve (see section 4.5.4 at page 39).
- Remove the water distributor (see section 4.5.5 at page 39).
- Proceed at reverse to refit the part.

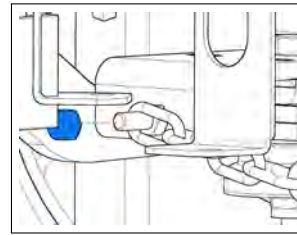

4.2.7-44

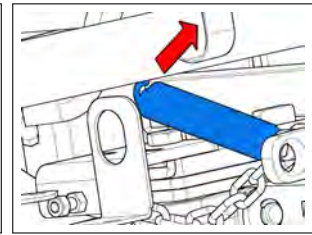

4.2.7-45

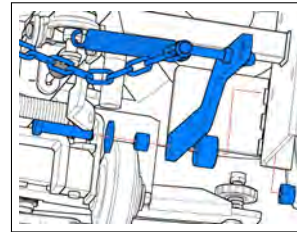

4.2.7-46

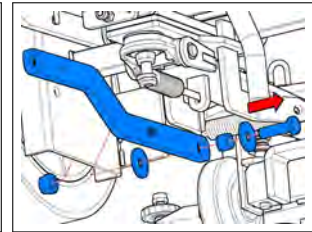

4.2.7-47

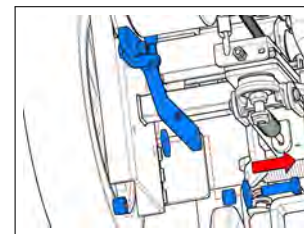

4.2.7-48

4.2.7 Brush deck lifting arms

- Put the machine in safe conditions.
- Lower the brush deck to the floor.
- Unlock the limit chain and release the brush deck return spring (see fig. 4.2.7-44) (see fig. 4.2.7-45).
- Unscrew the screws fixing the lift arms to the brush deck body.
- Unscrew the screws fixing the lift arms to the machine frame (see fig. 4.2.7-46) (see fig. 4.2.7-47) (see fig. 4.2.7-48).
- Proceed at reverse to refit the part (apply some lubricating grease on the bushings for a smooth movement of the arms).

4.2.8 Brass Bushings

- Put the machine in safe conditions.
- Disassemble the brush deck lifting arms (see section 4.2.7 at page 26).
- Replace worn out bushings with new ones (see fig. 4.2.8-49).
- Proceed at reverse to refit the part.
- Before fixing the lift arms, proceed to lubricate the bushings with grease.

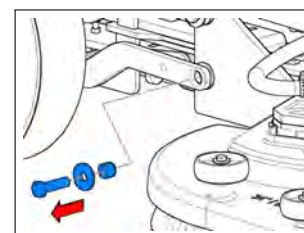

4.2.8-49

4.2.9 Brush Deck lifting Cable / Chain

- Put the machine in safe conditions.
- Lower the brush deck to the floor.
- Remove the screws that secure the front carter to the steering column.
- Remove the bottom panel of the electrical system.
- Remove the screws that secure the left footrest and remove it.
- Loosen the screw that secures the cable to the internal lifting lever (see fig. 4.2.9-50).
- Loosen the nut and locknut that secure the cable to the steering column (see fig. 4.2.9-51).
- Loosen the nut and locknut that secure the cable to the lower part of the frame (see fig. 4.2.9-52).
- Loosen the nut and locknut that secure the chain to the brush deck.
- Remove the chain joint that connects the chain to the lifting cable (see fig. 4.2.9-53).
- Remove the chain and the lifting cable.
- Proceed at reverse to refit the part.

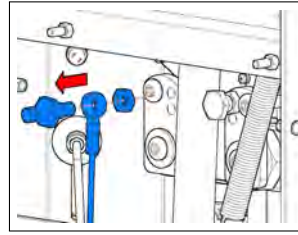

4.2.9-50

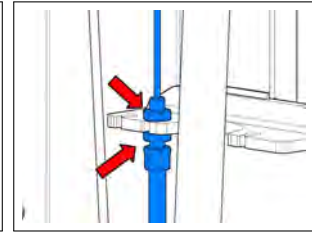

4.2.9-51

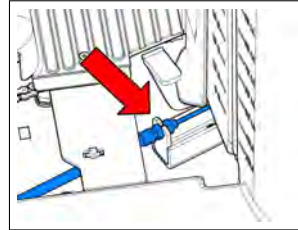

4.2.9-52

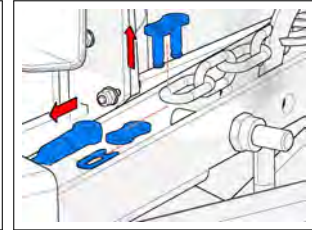

4.2.9-53

4.2.10 Brush deck and squeegee lifting levers

- Put the machine in safe conditions.
- Lower the brush deck to the floor.
- Remove the screws that secure the front carter to the steering column.
- Remove the screws that secure the electrical system support bracket to the steering column and loosen the electrical system. Be careful not to disconnect any cables (see fig. 4.2.10-54).
- Remove the fixing screws of the lever (see fig. 4.2.10-55).
- Proceed at reverse to refit the part (apply some lubricating grease on the bushings for a smooth movement of the levers).

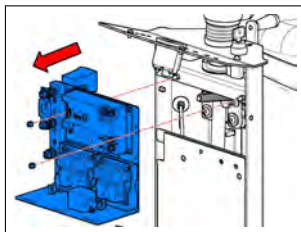

4.2.10-54

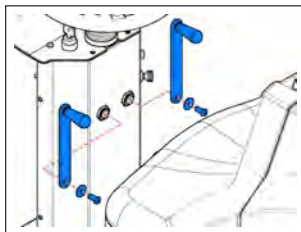

4.2.10-55

4.2.11 Extra pressure gas spring MR65, MR75, MR85

- Put the machine in safe conditions.
- Lower the brush deck to the floor.
- Remove the extra pressure carter.
- Remove the fixing fork of the gas spring to the brush deck (see fig. 4.2.11-56).
- Remove the fixing screw of the gas spring to the extra pressure lever (see fig. 4.2.11-57).
- Proceed at reverse to refit the part.

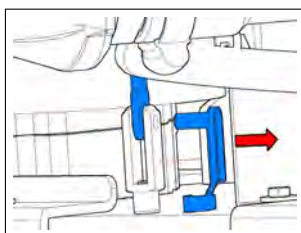

4.2.11-56

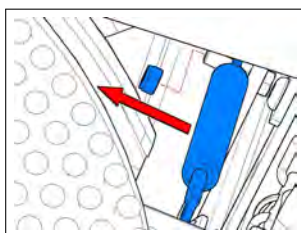

4.2.11-57

4.3 Drying System

4.3.1 Squeegee

- Put the machine in safe conditions.
- Unplug the Vacuum Hose.
- Loose the knobs that block the Squeegee to the Squeegee Support (see fig. 4.3.1-58).
- Move the squeegee sideways to release it from the squeegee support.
- Proceed at reverse to refit the part.
- Check the adjustment of the squeegee support.

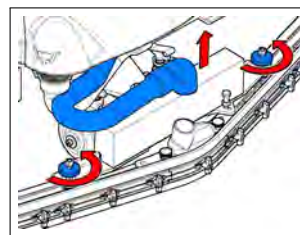

4.3.1-58

4.3.2 Squeegee wheels

- Put the machine in safe conditions.
- Remove the squeegee (see section 4.3.1 at page 28).
- Remove the screw that fix the wheel support to the squeegee support remove it (see fig. 4.3.2-59).
- Loosen the wing nut securing the wheel (see fig. 4.3.2-60).
- Remove the screw, the washer and the nut securing the wheel to the support (see fig. 4.3.2-61).
- Proceed at reverse to refit the part.
- Check the adjustment of the squeegee support.

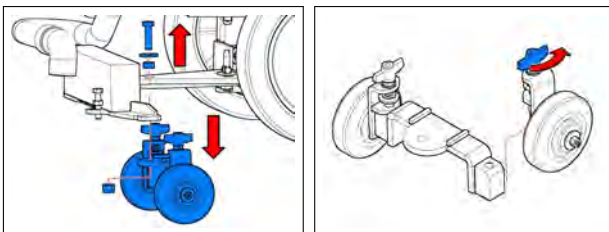

4.3.2-59

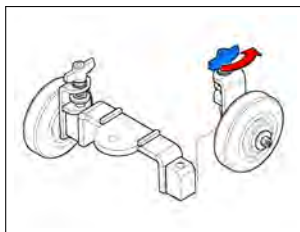

4.3.2-60

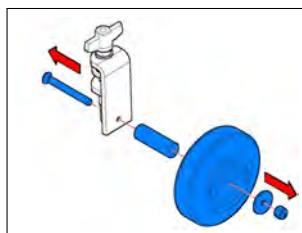

4.3.2-61

4.3.3 Squeegee Support

- Put the machine in safe conditions.
- Disassemble the Squeegee from the Machine (see section 4.3.1 at page 28).
- Remove the squeegee wheel support (see section 4.3.2 at page 29).
- Remove the fixing shackle of the squeegee lifting chain (see fig. 4.3.3-62).
- Unhook the tension spring connected to the back of the squeegee support.
- Remove the screw securing the tension spring (see fig. 4.3.3-63).
- Remove the squeegee support (see fig. 4.3.3-64).
- Proceed at reverse to refit the part.

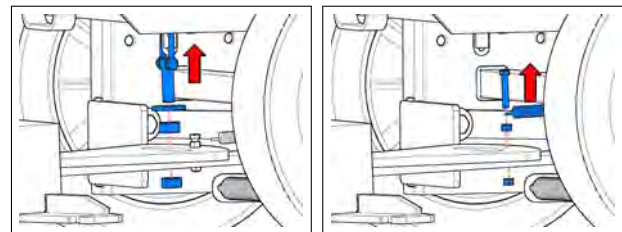

4.3.3-62

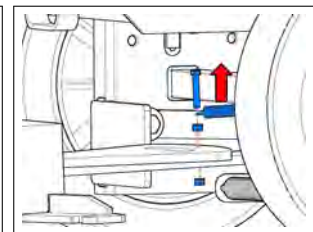

4.3.3-63

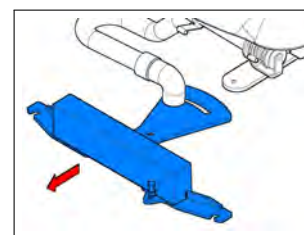

4.3.3-64

4.3.4 Squeegee front support

- Put the machine in safe conditions.
- Disassemble the Squeegee from the Machine (see section 4.3.1 at page 28).
- Remove the squeegee support (see section 4.3.3 at page 29).
- Unhook the tension spring connected to the back of the squeegee support (see fig. 4.3.4-65).
- Unhook the plates tension spring (see fig. 4.3.4-66).
- Disconnect the fixing pin of the squeegee front support with the squeegee support, removing the fastening seeger ring (see fig. 4.3.4-67).
- Remove the squeegee front support (see fig. 4.3.4-68).
- Proceed at reverse to refit the part.

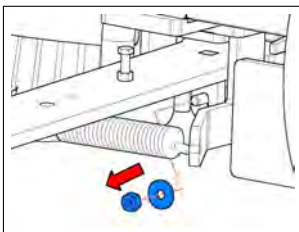

4.3.4-65

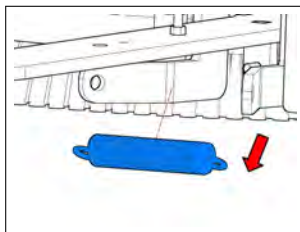

4.3.4-66

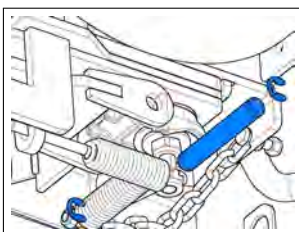

4.3.4-67

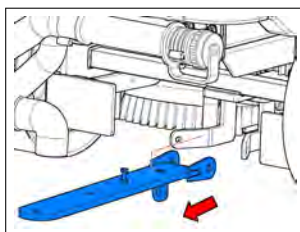

4.3.4-68

4.3.5 Squeegee coupling and top and bottom plates

- Put the machine in safe conditions.
- Remove the squeegee front support (see section 4.3.4 at page 30).
- Remove the fixing screw of the squeegee coupling and top and bottom plates (see fig. 4.3.5-69) (see fig. 4.3.5-70).
- Remove the squeegee coupling and top and bottom plates (see fig. 4.3.5-71).
- Proceed at reverse to refit the part.

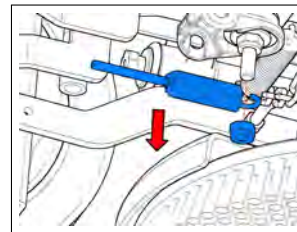

4.3.5-69

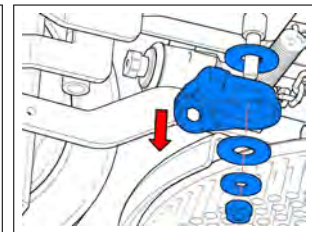

4.3.5-70

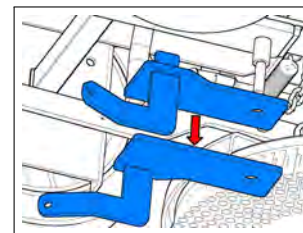

4.3.5-71

4.3.6 Squeegee lifting chain

- Put the machine in safe conditions.
- Remove the squeegee support (see section 4.3.3 at page 29).
- Disconnect the chain from the fixing shackle (see fig. 4.3.6-72).
- Disconnect the chain from the lifting cable (see fig. 4.3.6-73).
- Remove the lifting chain.
- Proceed at reverse to refit the part.

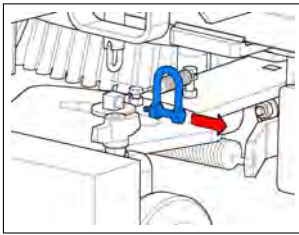

4.3.6-72

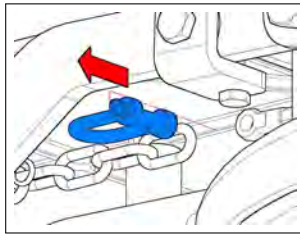

4.3.6-73

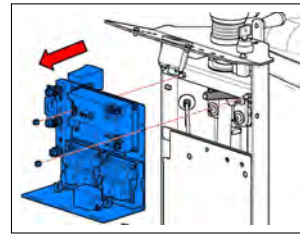

4.3.7-74

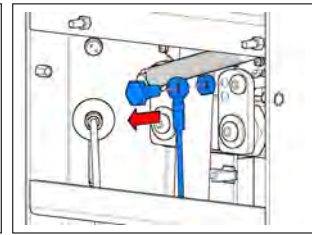

4.3.7-75

4.3.7 Squeegee lifting cable

- Put the machine in safe conditions.
- Lower the brush deck to the floor.
- Remove the screws that secure the front carter to the steering column.
- Remove the screws that secure the electrical system support bracket to the steering column and loosen the electrical system. Be careful not to disconnect any cables (see fig. 4.3.7-74).
- Remove the bottom panel of the electrical system.
- Remove the screw that secures the cable to the internal lifting lever (see fig. 4.3.7-75).
- Loosen the nut and locknut that secure the cable to the steering column (see fig. 4.3.7-76).
- Loosen the nut and locknut that secure the cable to the machine frame (see fig. 4.3.7-78).
- Remove the squeegee support (see section 4.3.3 at page 29).
- Open the shackle that connects the squeegee lifting cable with the chain (see fig. 4.3.7-77).
- Pull out the squeegee lifting cable.
- Proceed at reverse to refit the part.

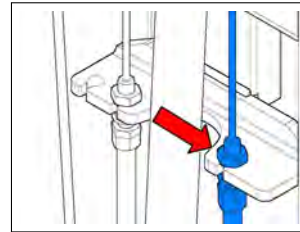

4.3.7-76

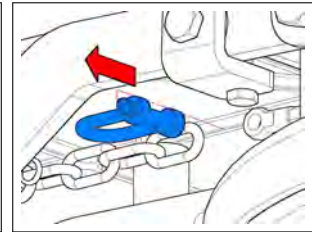

4.3.7-77

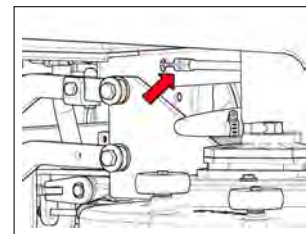

4.3.7-78

4.3.8 Vacuum Hose

- Put the machine in safe conditions.
- Unplug the Vacuum Hose from the Squeegee (see fig. 4.3.8-79).
- Uncouple the Vacuum Hose from the Recovery tank upper Inlet (see fig. 4.3.8-80).
- Slip off the hose from its housing.
- Proceed at reverse to refit the part.

4.3.9 Drain Hose

- Put the machine in safe conditions.
- Disconnect the drain hose of the recovery tank, removing the screw clamp (see fig. 4.3.8-81).
- Proceed at reverse to refit the part.

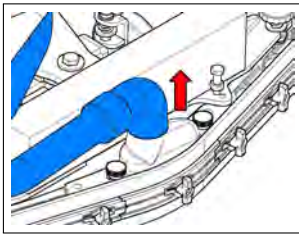

4.3.8-79

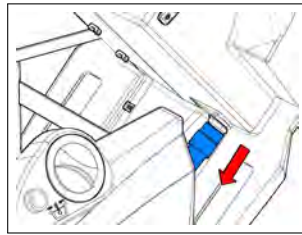

4.3.8-80

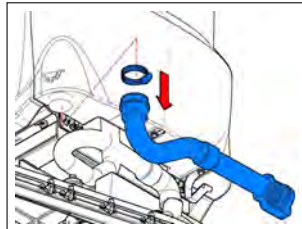

4.3.8-81

4.3.10 Suction hood

- Put the machine in safe conditions.
- Remove the screws securing the vacuum motor crankcase (see fig. 4.3.10-82).
- Disconnect the electrical connector for power supply.
- Remove the fixing screws of support platelets of the suction hood and remove it (see fig. 4.3.10-83) (see fig. 4.3.10-84).
- Proceed at reverse to refit the part.

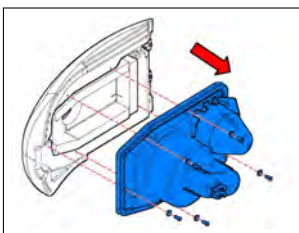

4.3.10-82

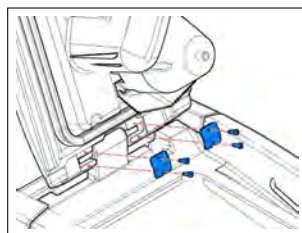

4.3.10-83

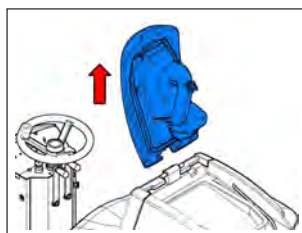

4.3.10-84

4.3.11 Vacuum Motor

- Put the machine in safe conditions.
- Remove the screws securing the vacuum motor crankcase (see fig. 4.3.11-85).
- Disconnect the power cords of the Vacuum Motor.
- Remove the vacuum motor (see fig. 4.3.11-86).
- Proceed at reverse to refit the part.

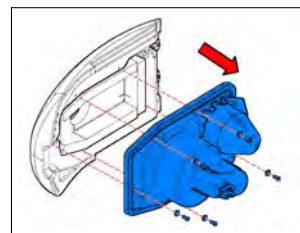

4.3.11-85



4.3.11-86

4.3.12 Recovery Tank

- Make sure that the recovery tank is completely empty, otherwise provide to empty it.
- Put the machine in safe conditions.
- Remove the suction hood (see section 4.3.10 at page 32).
- Remove the vacuum hose (see section 4.3.8 at page 31).
- Remove the drain hose (see section 4.3.9 at page 31).
- Remove the seat (see section 4.4.11 at page 37).
- Remove the deadman switch (see section 4.1.7 at page 20).
- Disconnect the wiring harness.
- Remove the safety lever (see fig. 4.3.12-87).
- Unscrew the screws holding the opening hinges to the recovery tank (see fig. 4.3.12-88).
- Remove the recovery tank.
- Remove all components attached to the recovery tank (fixing cable sideburns, pipe supports, etc.).
- Proceed at reverse to refit the part.

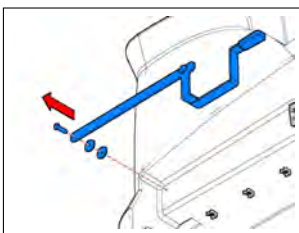

4.3.12-87

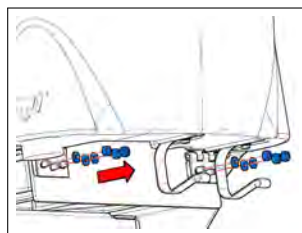

4.3.12-88

4.4 Frame and Traction System

4.4.1 Rear Wheels

- Put the machine in safe conditions.
- Lift up the related rear wheel from the ground.
- Remove the hub cap by levering with a small flat screwdriver.
- Loosen the fixing bolt of the wheel to the support on the frame (see fig. 4.4.1-89).
- Remove the wheel.
- Proceed at reverse to refit the part.

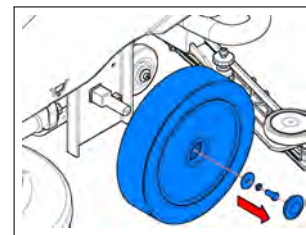

4.4.1-89

4.4.2 Front Wheel

- Put the machine in safe conditions.
- Lift up the front wheel from the ground.
- Remove the screws that secure the wheel support plate to the wheel holder.
- Remove the screw that secures the wheel to the pinion (see fig. 4.4.2-90).
- Remove the wheel support plate.
- Remove the wheel from its axle (see fig. 4.4.2-91).

- Proceed at reverse to refit the wheel (Use the thread lock liquid on the screw during the assembling).

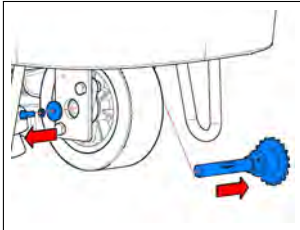

4.4.2-90

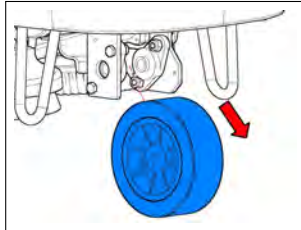

4.4.2-91

4.4.3 Brake plate

- Put the machine in safe conditions.
- Remove the front wheel (see section 4.4.2 at page 33).
- Remove the screw securing the brake pedal.
- Remove the round head screw with the relative spring (see fig. 4.4.3-92).
- Pull out the brake plate from its housing (see fig. 4.4.3-93).
- Proceed at reverse to refit the part.

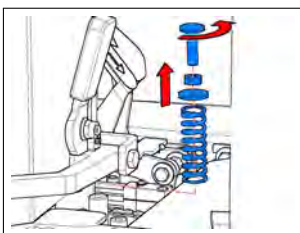

4.4.3-92

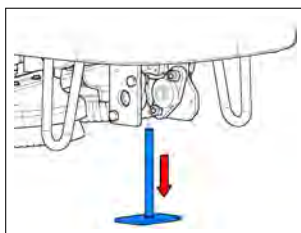

4.4.3-93

4.4.4 Pinion and shaft traction wheel

- Put the machine in safe conditions.
- Remove the protective cover of the traction wheel (see fig. 4.4.4-94).
- Remove the drive chain (see fig. 4.4.4-95).
- Remove the screw securing the pinion to the traction motor (see fig. 4.4.4-96).
- Remove the traction wheel shaft (see fig. 4.4.4-97).
- Proceed at reverse to refit the part.

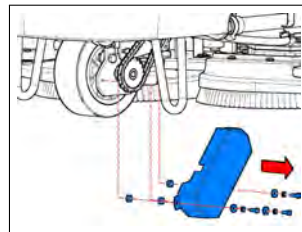

4.4.4-94

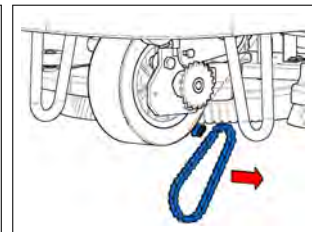

4.4.4-95

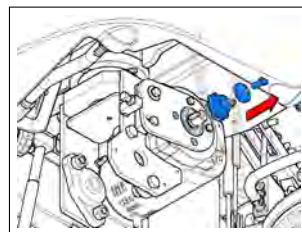

4.4.4-96

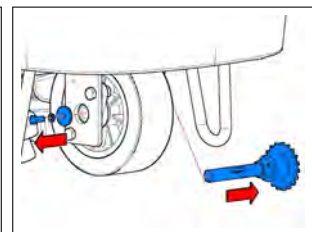

4.4.4-97

4.4.5 Traction gearmotor

- Put the machine in safe conditions.
- Remove the traction pinion only (see section 4.4.4 at page 34).
- Remove the screws securing the Traction Gearmotor to the plate (see fig. 4.4.5-98).
- Remove the traction gearmotor paying attention to the little key (see fig. 4.4.5-99).
- Proceed at reverse to refit the part.

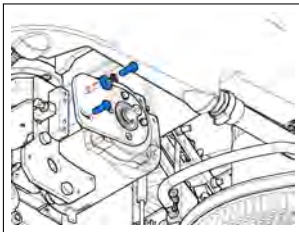

4.4.5-98

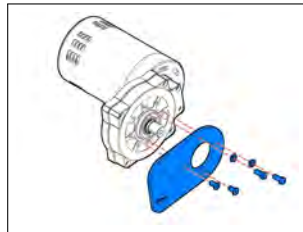

4.4.5-99

- Pull out the steering shaft from the upper support (see fig. 4.4.6-104).
- Proceed at reverse to refit the part.

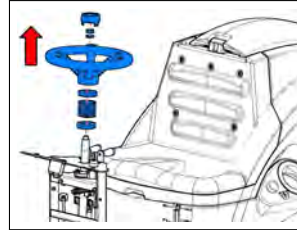

4.4.6-100

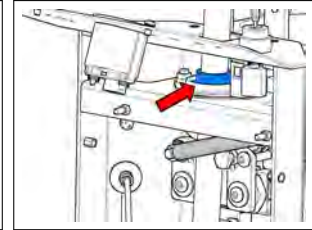

4.4.6-101

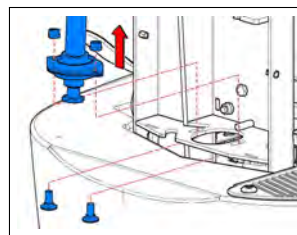

4.4.6-102

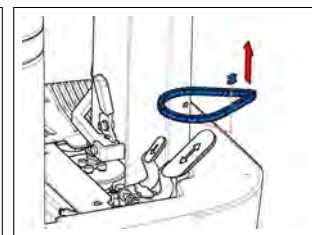

4.4.6-103

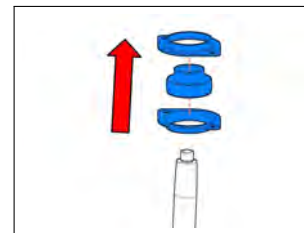

4.4.6-104

4.4.6 Steering shaft

- Put the machine in safe conditions.
- Remove the screws that secure the front carter to the steering column.
- Unscrew the nuts securing the electrical system support plate and remove it.
- Remove the steering wheel from the machine (see fig. 4.4.6-100).
- Loosen the fixing screws of the steering shaft upper support (see fig. 4.4.6-101).
- Remove the flange of the the steering shaft lower support (see fig. 4.4.6-102).
- Remove the chain from the steering shaft (see fig. 4.4.6-103).

4.4.7 Steering bearing

- Put the machine in safe conditions.
- Remove the steering shaft (see section 4.4.6 at page 35).
- Remove the screws of the bearing locking flange (see fig. 4.4.6-104).
- Remove the bearing.
- Proceed at reverse to refit the part.

4.4.8 Steering Chain

- Put the machine in safe conditions.
- Remove the screws that secure the front carter to the steering column.
- Loosen the screws that secure the lower support of the steering shaft (see fig. 4.4.8-105).
- Remove the chain joint (see fig. 4.4.8-106).
- Remove the chain from the sprocket.
- Proceed at reverse to refit the part.

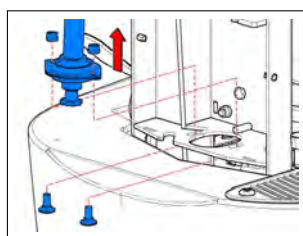

4.4.8-105

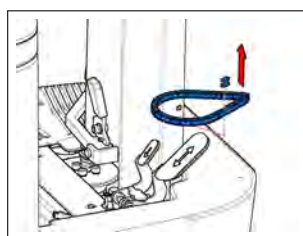

4.4.8-106

4.4.9 Steering Sprocket

- Put the machine in safe conditions.
- Remove the screws that secure the front carter to the steering column.
- Remove both footrests.
- Remove the parking brake pedal.
- Remove the footrest support (see fig. 4.4.9-107) (see fig. 4.4.9-108).
- Remove the steering chain (see section 4.4.8 at page 36).
- Remove the screws securing the sprocket to the wheel hub (see fig. 4.4.9-109).
- Remove the steering sprocket.
- Proceed at reverse to refit the part.



4.4.9-107

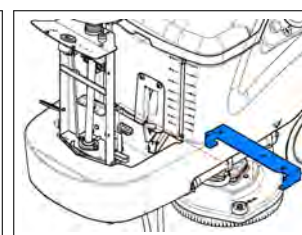

4.4.9-108

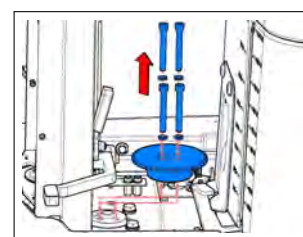

4.4.9-109

4.4.10 Traction Pedals

- Put the machine in safe conditions.
- Remove the right footrest.
- Unhook the pedal return spring (see fig. 4.4.10-110).

- Remove the fixing screws of the pedals to the support plate (see fig. 4.4.10-111).
- Disconnect the pedals from the threaded rod.
- Remove the pedals from the support plate.
- Proceed at reverse to refit the part.

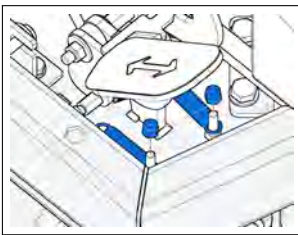

4.4.10-110

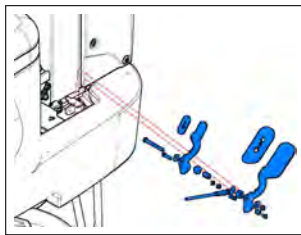

4.4.10-111

4.4.11 Seat

- Put the machine in safe conditions.
- Unscrew the lower screws and the rear screws that fix the seat (see fig. 4.4.11-112).
- Remove the seat from the machine.
- Proceed at reverse to refit the part.

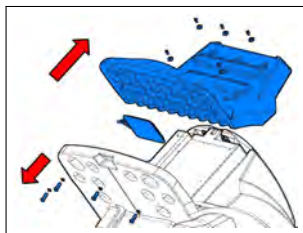

4.4.11-112

4.5 Solution Delivery System

4.5.1 Solution Tank

- Make sure that the solution tank is completely empty, otherwise provide to empty it.
- Put the machine in safe conditions.
- Remove the recovery tank (see section 4.3.12 at page 33).
- Remove both footrests.
- Remove the footrest support (see fig. 4.5.1-113).
- Remove the screws that secure the front carter to the steering column.
- Disconnect the outlet water hose from the tank (see fig. 4.5.1-114).
- Remove the battery tray (see fig. 4.5.1-115).
- Remove the screws that secure the solution tank to the machine frame and remove it (see fig. 4.5.1-116).
- Proceed at reverse to refit the part.

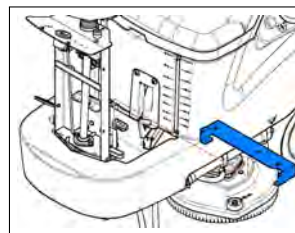

4.5.1-113

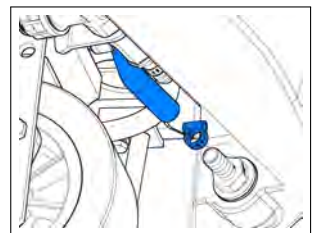

4.5.1-114

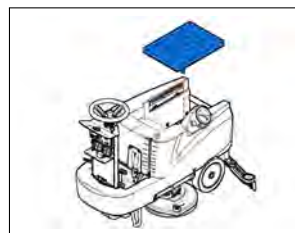

4.5.1-115

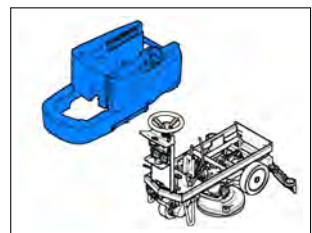

4.5.1-116

4.5.2 Hoses

- Put the machine in safe conditions.
- Loosen the clamps that hold the hose to the fitting.
- Cut any eventual clamps that secure the hose to the machine body.
- Remove the hose from the fitting.
- Proceed at reverse to refit the part.

4.5.3 Water Valve / Solution Filter

- Make sure that the solution tank is completely empty, otherwise provide to empty it.
- Put the machine in safe conditions.
- Disconnect the control rod from the water valve (see fig. 4.5.3-117).
- Disconnect the hose from the fitting, attached to the water valve (see fig. 4.5.3-118).
- Disconnect the hose from the fitting attached to the solution filter (see fig. 4.5.3-119).
- Loosen the screws that hold the support plate to the solution filter and remove it together with the water valve (see fig. 4.5.3-120).
- Unscrew the straight fitting attached to the water valve.
- Unscrew the water valve from the nipple fitting and remove it.
- Remove the solution filter (see fig. 4.5.3-121).
- Proceed at reverse to refit the part.

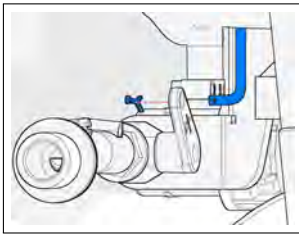

4.5.3-117

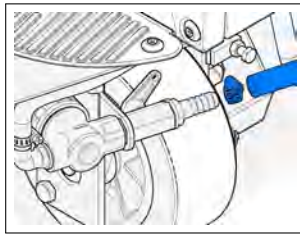

4.5.3-118

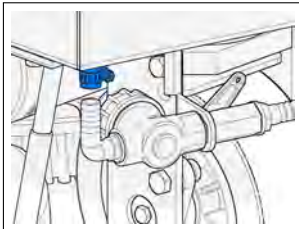

4.5.3-119

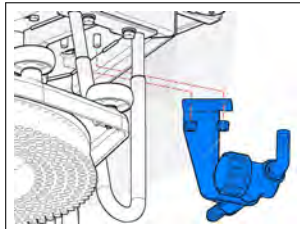

4.5.3-120

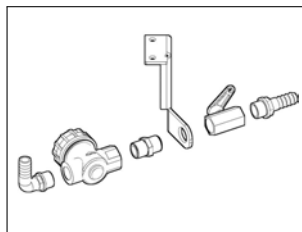

4.5.3-121

4.5.4 Solenoid Valve

- Put the machine in safe conditions.
- Remove the hoses connected to the solenoid valve.
- Unscrew the nut that secures the solenoid valve to its support.
- Loosen the screw that secures the solenoid connector and disconnect the connector from the solenoid coil (see fig. 4.5.5-122).
- Proceed at reverse to refit the part.

4.5.5 Water Distributor

- Put the machine in safe conditions.
- Remove the hoses connected to the distributor.
- Remove the screws that secures the distributor to the elbow fitting (see fig. 4.5.5-123).
- Proceed at reverse to refit the part.

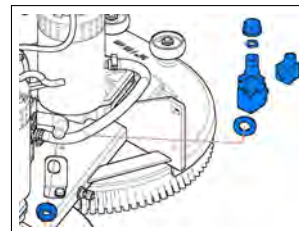

4.5.5-122

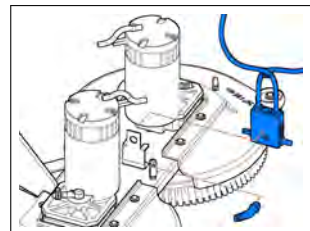

4.5.5-123

Part III

Machine Description

Chapter 5

Electrical System

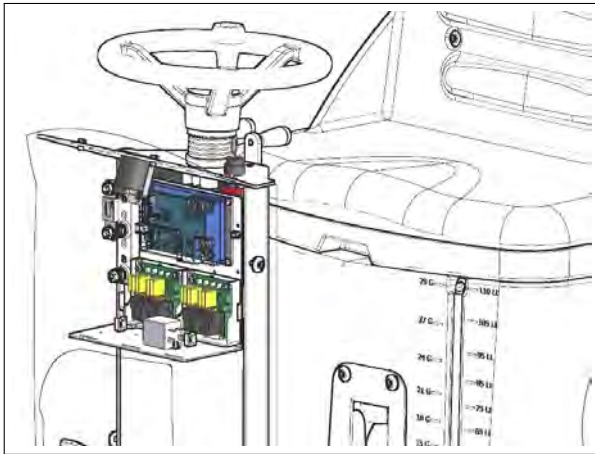

5.1 Structure

- Hourmeter
- Key switch
- Horn
- Traction Card
- Relay Card
- Traction relay
- Microswitches: brush motor, vacuum motor, backward disabling, deadman switch, traction switch, forward/reverse switch, brush head switch, solution switch, parking brake and extra pressure
- Potentiometer
- Batteries and battery charger

5.2 Description

The key switch supply the power to the entire electrical system of the machine.

The washing and drying functions are managed by the relay cards. The microswitches actuated by the lifting levers on the steering column and by the traction pedal gives the consent to work.

The traction is managed by a dedicated traction card, according to the signals received from the electronic devices of the machine.

In particular, the micro switches related to the traction of the machine are those driven by the traction pedal, the deadman microswitch, the potentiometer to adjust the traction speed and the backward disabling micro in case of lowered squeegee.

Upstream of all incoming signals to traction card, there is a relay that supplies power to the card itself when the machine is powered.

5.3 Location of Electrical Components

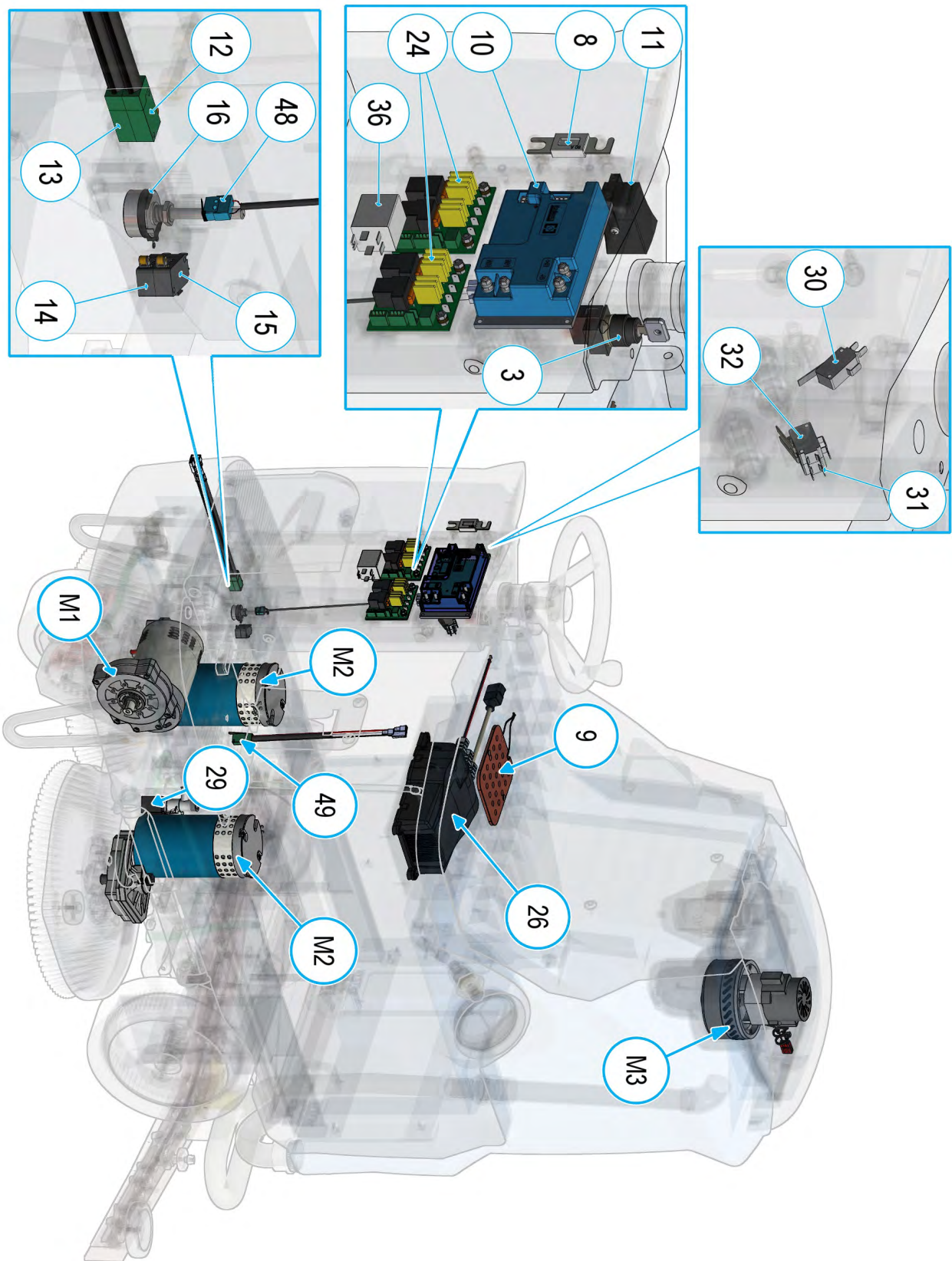

5.3.1 List of Components

- 3 Key switch
- 8 Main fuse (80 Amps)
- 9 Deadman microswitch
- 11 Horn
- 10 Traction card
- 12 Solution microswitch
- 13 Forward/reverse microswitch
- 14 Brush head microswitch
- 15 Traction microswitch
- 16 Pedal microswitch potentiometer
- 24 Relay card
- 26 Battery charger ¹
- 29 Solenoid Valve
- 30 Brush motor microswitch
- 31 Vacuum motor microswitch
- 32 Backward disabling microswitch with squeegee down
- 36 Traction relay
- 48 Parking brake microswitch
- 49 Extra pressure microswitch
- M1 Traction motor
- M2 Brush motor
- M3 Vacuum motor

¹Optional

5.3.2 Hourmeter

The machine is provided with an electronic hourmeter installed on the control panel which, in addition to counting the time of use of the machine (only when it is in traction), it allows to display in real time the battery charge level by means of a series of LEDs. The device also allows to interrupt the working cycle of the machine in the case the threshold of discharge of the battery is close to levels that can affect its life cycle. The device can be adjusted according to the type of batteries installed on the machine.

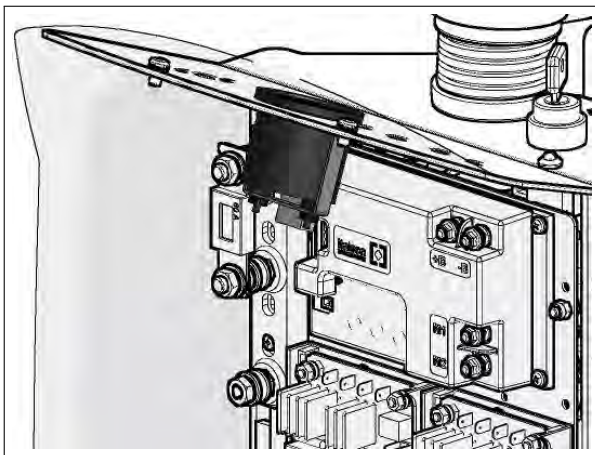

5.3.3 Key switch

The key switch provides the power supply to the whole machine.

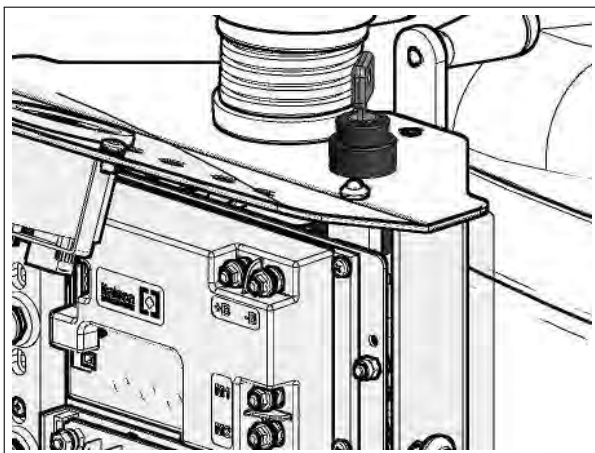

5.3.4 Buzzer

The buzzer is a safety device that is activated when the reverse traction is engaged. The same device also has the function of a horn.

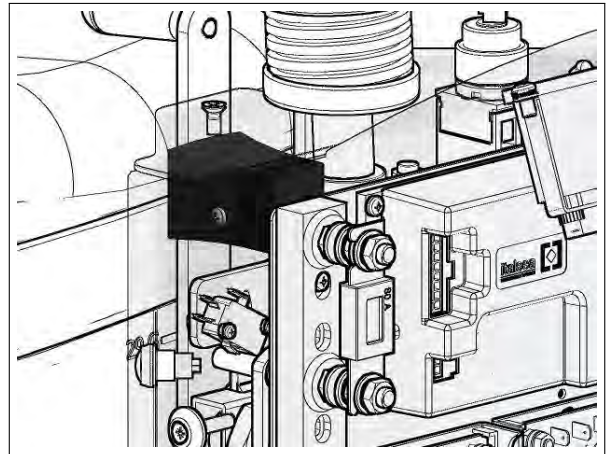

5.3.5 Traction Card

The traction card handles all the signals from the micro switches and the potentiometer, in order to supply current to the traction motor. The traction relay provides the positive power supply to the traction card, while the negative supply is taken directly from the battery. The traction motor is directly connected to the card.

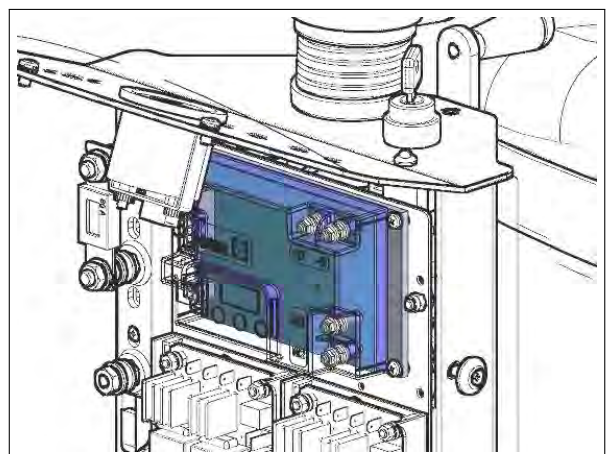

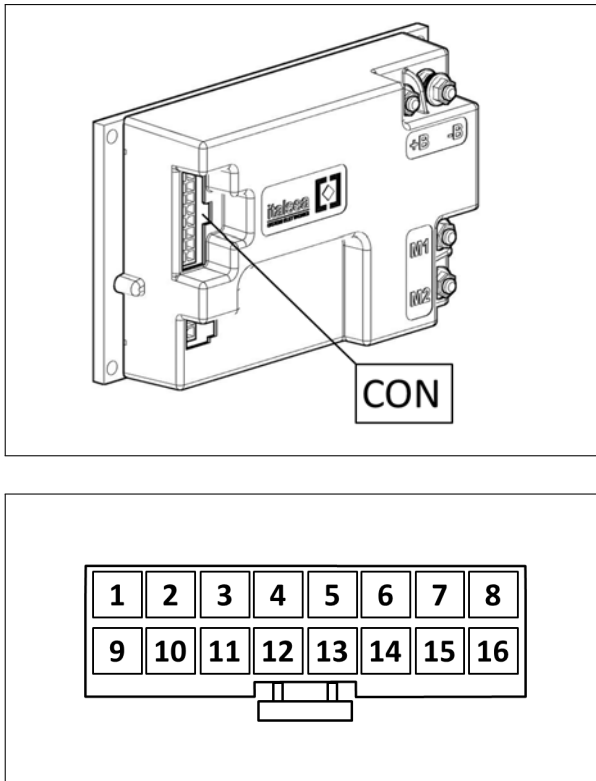

Figure 5.1: Traction card connector inputs

Input signals

The input signals to the traction card are:

Input signals	
1	Potentiometer (+)
2	Potentiometer (C)
3	Potentiometer (-)
4	Not used
5	Deadman microswitch
6	General negative
7	Not used
8	Positive buzzer
9	Negative buzzer
10	Not used
11	Not used
12	Forward traction microswitch
13	Backward disabling microswitch
14	Traction microswitch
15	Key contact
16	General Positive through hourmeter

5.3.6 Microswitches

The machine is provided with a series of microswitches to enable/disable certain functions or to send signals to the traction card. In particular:

- **Brush motor Microswitch** (see fig. 5.3.6-1). The micro is on the brush deck lifting lever. With lowered brush deck lifting lever and closed micro the deck goes down to the floor and the brush motor starts running (as long as the gear pedal is pressed). The cleaning function is active.
- **Vacuum motor Microswitch** (see fig. 5.3.6-2). The micro is on the squeegee lifting lever. With lowered squeegee lifting lever and closed micro the squeegee goes down to the floor and the vacuum motor starts running. The drying function is active.
- **Backward disabling Microswitch** (see fig. 5.3.6-3). The micro is coupled to the vacuum motor microswitch. With lowered squeegee lever and activated drying function (closed microswitch) the backward traction is inhibited.
- **Deadman Microswitch** (see fig. 5.3.6-4). The micro switch is located below the seat. With the operator on board, the traction can be activated.
- **Traction Microswitch** (see fig. 5.3.6-5). The micro is located on the base connected to the accelerator pedal. When the accelerator pedal is pressed and the micro is closed, the traction card is enabled (as long as the deadman micro is pressed).

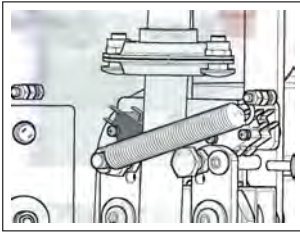

5.3.6-1

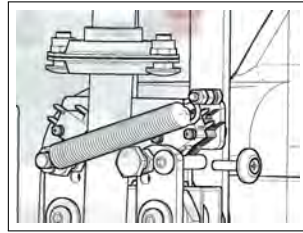

5.3.6-2

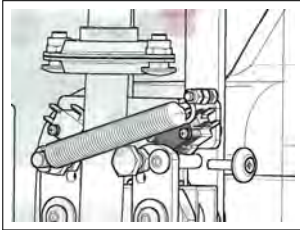

5.3.6-3

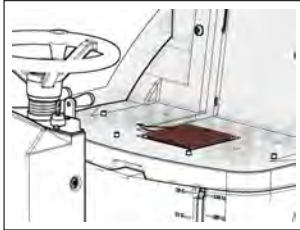

5.3.6-4

• **Forward/Reverse Microswitch** (see fig. 5.3.6-6). The micro is directly connected to the backward pedal. When the reverse pedal is not pressed, the traction card receives the signal to the forward direction (as long as the accelerator pedal is pressed). With the reverse pedal pressed (in conjunction with the accelerator pedal), the traction card receives the signal to the backward direction.

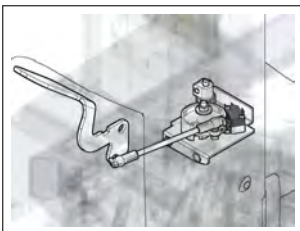

5.3.6-5

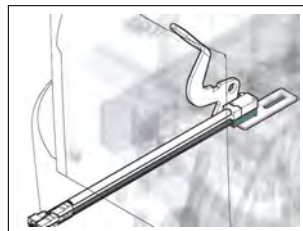

5.3.6-6

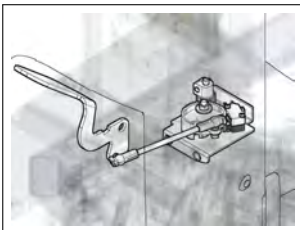

5.3.6-7

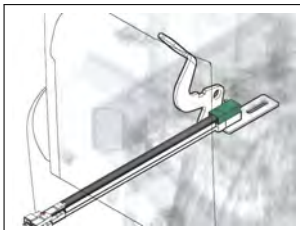

5.3.6-8

• **Brush deck Microswitch** (see fig. 5.3.6-7). The micro is located on the base connected to the accelerator pedal. With traction pedal pressed and closed micro, the brush deck is enabled (as long as the brush deck lever is lowered).

• **Solution Microswitch** (see fig. 5.3.6-8). The micro is connected to the backward pedal. With backward pedal not pressed the micro opens the solenoid valve for the water flow (as long as the brush deck lever is lowered).

• **Parking brake Microswitch** (see fig. 5.3.6-9). The micro is located near the parking brake lever. When the brake is activated the traction of the machine is disabled (both forward and backward). On the control panel a red light turns on.

• **Extra pressure Microswitch** (see fig. 5.3.6-10). The micro is close to the extra pressure actuating lever. With extra pressure lever activated, on the control panel a green light turns on.

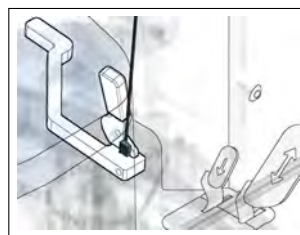

5.3.6-9

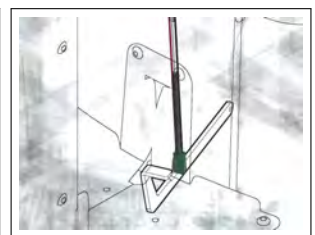

5.3.6-10

5.3.7 Potentiometer

The micro is located on the base connected to the accelerator pedal. The potentiometer provides the speed signal to the traction card.

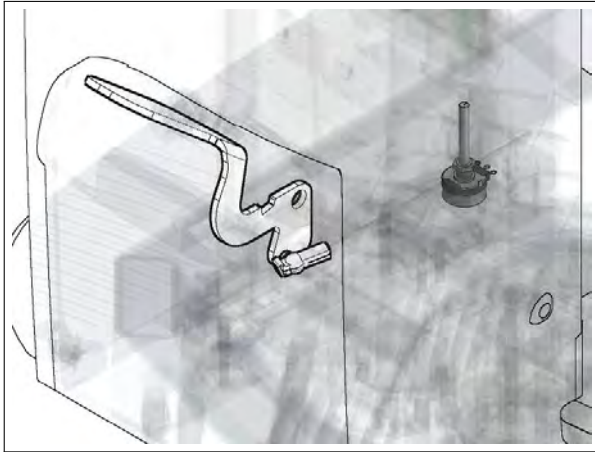

5.3.8 Batteries and battery charger

The machine is available with the optional battery charger. To get access to the battery charger and the battery compartment is enough to lift the recovery tank which is provided with a specific safety lever.

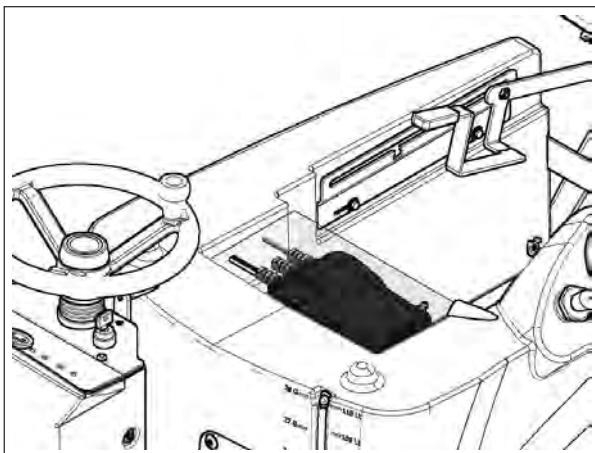

5.4 Adjustments

5.4.1 Traction card

The Traction card is properly adjusted during assembly of the machine. All the parameters for the traction of the machine, are set and controlled during assembly and testing.

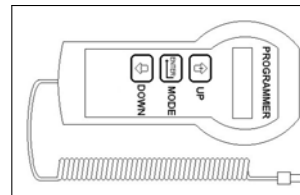

5.4.1-11

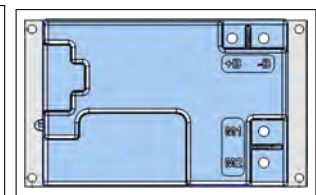

5.4.1-12

If it is necessary to replace the traction card or the speed potentiometer, it is **ALWAYS** necessary to calibrate the potentiometer, so that the machine can work properly. The calibration of the speed potentiometer is performed by checking and setting the parameters correctly in the traction card, with the appropriate console.

Procedure:

- Put the machine in safe conditions.
- Remove the steering wheel carter.
- When the machine is turned Off, connect the console to the traction card.
- Turn on the machine.
- Enter into the parameters list using the MODE button.
- Select the parameter “Speed Reference”.
- Select the “single-ended” option and confirm with MODE button.

- Put the pedal in the idle condition and confirm its value using the MODE button.

- Press completely the traction pedal and while it is pressed, confirm the value using the MODE button.

IMPORTANT: this operation must be done with footrest installed correctly.

- Turn off the machine.
- Disconnect the console from the traction card.
- Restore the steering wheel carter.

5.4.2 Microswitch

Check functionality and conditions of the microswitches. Check that with microswitch pressed, remains about 0.5 mm clearance between the lever and the body of the microswitch. Make sure the lever of the micro is working properly. Otherwise, proceed as follows:

- Unscrew the fixing screws.
- Move the microswitches using the loop adjustment.
- Fix the screws to lock the microswitches taking care not to over tighten in order not to ruin the devices.
- When the setting is finished, verify the correct functionality of the microswitches.

5.4.3 Hour meter

Check operation and condition of the hourmeter.

Make sure that as soon as you press the accelerator pedal to move or work with the machine, the hourmeter actually starts counting the working hours.

An hourglass will flash on the display near the working hours.

Check the correct setting of the battery control card with the installed batteries.

When the machine is turned On, the battery control card illuminate a single yellow LED corresponding to the setting of the card. The LED display will be:

Setting of battery type	
LED	Battery type
1	Lead Acid Batteries
4	GEL or AGM Batteries

To properly adjust the battery control card, proceed as follows:

- Put the machine in safe conditions.
- Remove the steering wheel carter.
- On the back of the hourmeter, turn the round micro in the desired position. The possible adjustment positions ranging from 0 to 7.
- Restore the steering wheel carter.

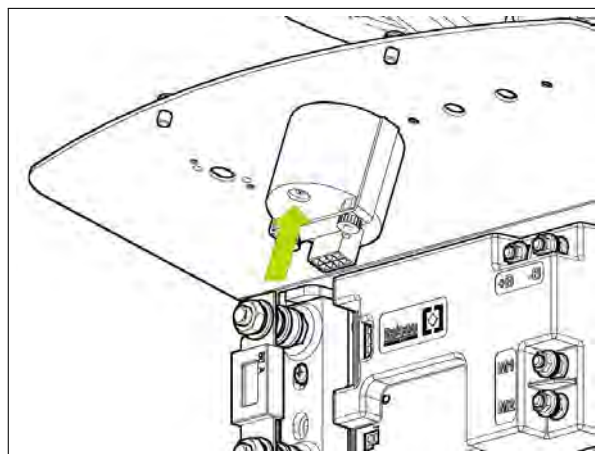

5.4.4 Battery Charger (CB)

The battery charger is located inside the battery compartment, underneath the operator seat and is easily accessible by lifting the recovery tank. At the start of the charging cycle, the charger indicates the selected charging algorithm by the LED flashing.

A Proper Charging cycle follows the below phases order.

Charging cycle		
Phase	LED	Description
A	Red	2 Flashes, set for Lead Acid Batteries
	Green	2 Flashes, set for GEL or AGM Batteries
B	Red	First charging phase
C	Yellow	Second charging phase
D	Green	Charged battery

Check if the charger is properly set according to the installed batteries.

Charging curve SetUp

To set up the charger, follow the instructions:

- Lift the label on the charger.
- Set-up the internal dipswitches according to the following table

The dipswitches are divided in two couple. The left couple are the dipswitches 1 and 2, the right couple are the dipswitches 3 and 4. The following table shows how to setup the dipswitches 1 and 2.

DP3: OFF (not used)
DP4: OFF (not used)



5.4.4-13

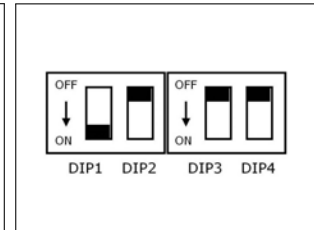

5.4.4-14

Set-up of Charging Curve

DP1	DP2	Set Up	Flash
OFF	OFF	Exide Sonnenschein	2 Green
ON	ON	Trojan	2 Green
OFF	ON	GEL / AGM / Crown	2 Green
ON	OFF	Wet Cell	2 Red

Error Codes of Charger

The charger have an alarm system through successive flashes of the LEDs.

Error code	
Flash	Description
Yellow	Unsuitable battery Battery not connected Output short circuit
Red	Safety timer exceeded Internal short circuit

5.5 Maintenance and Checks

5.5.1 Electrical System

Check (to perform every **150h**)

Check the functions and the proper connections of the switches, microswitches, motors, solenoid valve, power fuses, thermal fuses, battery loop wires, relay cards and traction card. Check periodically, the wiring connections status. To get access to the electrical system, remove the steering wheel carter.

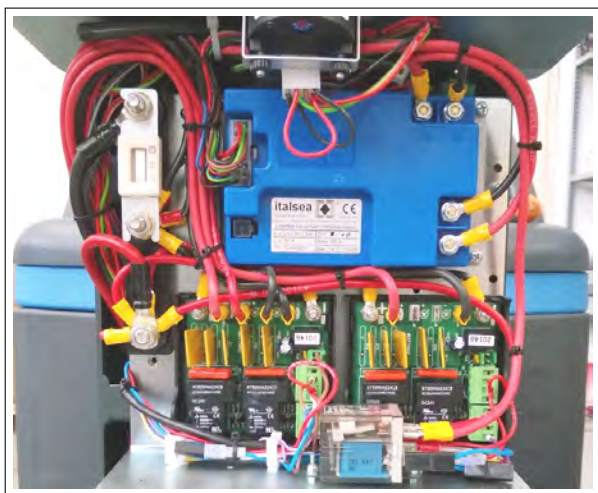
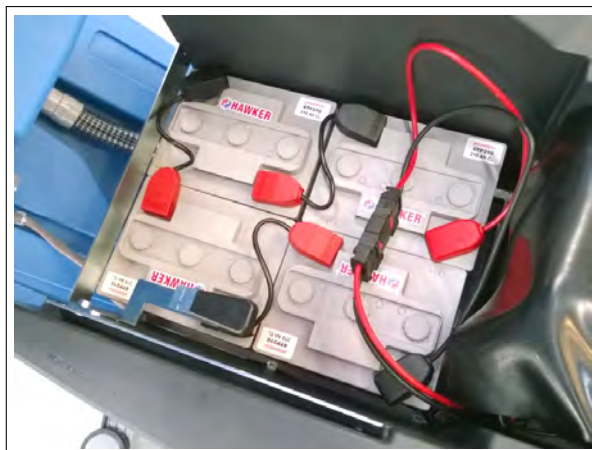

5.5.2 Batteries

Check (to perform every **150h**)

Check the proper connection of the Loop wire on the batteries and the cleanliness of the contacts. Verify that there is no rust on the battery connections.

5.6 Alarm Table - Traction Card

Id Alarm	Meaning	Solution
ALARM A1 FW Switch ON	Forward micro-switch turned on	Put the potentiometer in idle position and check that the forward micro-switch is open.
ALARM A2 BW Switch ON	Backward micro-switch turned on	Let the pedal stay in idle position and open the backward micro-switch.
ALARM A3 Pot. FAULT	Potentiometer error	Check the potentiometer harness.
ALARM A4 Ref OUT Neutral	Potentiometer not correctly positioned	Put the potentiometer in the idle position or if it already is in the right position, adjust the potentiometer program.
ALARM A5 Overtemperature	Thermal protection	Wait for 5 minutes and then check the traction motor absorption rate.
ALARM A6 POWER STAGE	Damaged power stage	Replace the traction card.
ALARM A7 OVERCURRENT	Overcurrent	Check the motor cables: If connections are regular and repeat the alarm, replace the traction card.
ALARM A8 POWER FUSE/ RELAY	Power fuse or internal contactor damaged	Check the fuse on the + battery and wiring, replace the traction card if it persists (General relay damaged).
ALARM A9 UNDERVOLTAGE	Undervoltage	Check the batteries for poor voltage.
ALARM A10 OVERVOLTAGE	Overvoltage	Battery voltage greater than 45V: check battery status.
ALARM A11 Overload Current	Current protection	Check the motor current and possibly trim the electronic current control.
ALARM A12 DISABLE ON	Disabling active	Check the status of the disabling Input.
ALARM A13 KEY-OFF	Turn off sequence active	Check the wiring on the ignition power.
ALARM A14 EEPROM FAIL	EEProm data reading failed	Check the settings: if the alarm is repeated, replace the traction card.

5.7 Menu tables - Traction Card

5.7.1 Menu scheme

- Make sure the machine is turned off.
- Connect the console to the traction card via the connector on the board.
- Turn on the machine and operate with the console.
- When finish, exit from all the parameters and turn Off the machine.
- Disconnect the console from the machine.

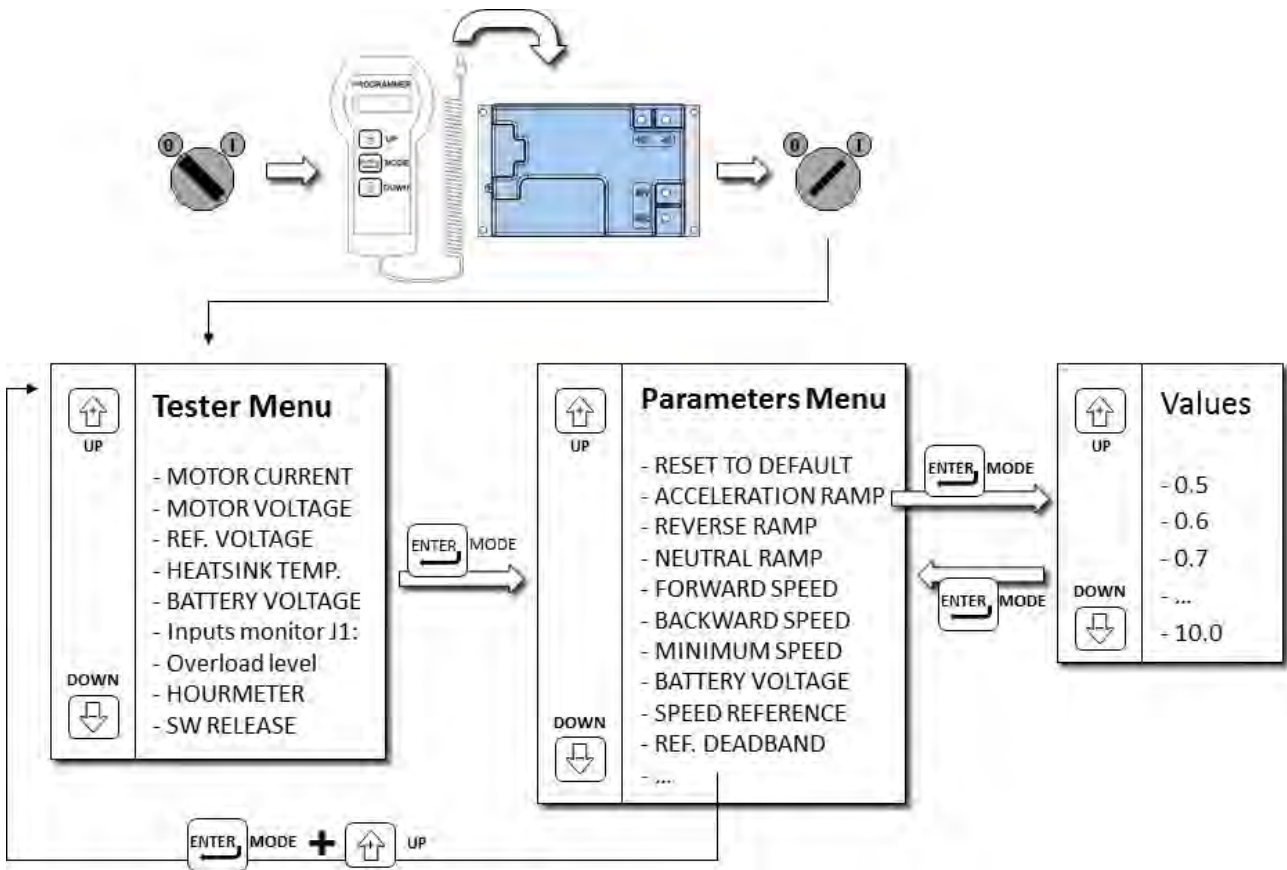

- For the submenus of the Parameter Menu, refer to the specific tables.

5.7.2 Tester Menu

MENU	DESCRIPTION
SW RELEASE 7CH4Q90F.10	Software release number.
MOTOR CURRENT Imot= ## Amps	Motor Current.
MOTOR VOLTAGE Vmot = ##.# Volts	Motor Voltage.
REF. VOLTAGE Vref = ##.# Volts	Speed reference voltage (potentiometer).
HEATSINK TEMP. T= ##C / ###F	Internal heat-sink temperature.
BATTERY VOLTAGE Vbatt= ##.# Volts	Battery supply voltage.
Inputs monitor J1: #, #, #, #, #, #	Connector's Inputs status.
Overload level: ##% (at ##Amps)	Ammeter protection (overload) level; at 100% alarm A11 is active.
HOURLY METER #### hrs, ## min	Measure of worked time (when motor is running).

5.7.3 Parameters Menu

Main Parameters

Parameter	Default	Min ÷ Max	Description
RESET TO DEFAULT #####	0	- ÷ -	Reset all parameters to the default settings.
ACCELERATION RAMP #. # seconds	3.0	0.5 ÷ 10.0	Time from stop position to max speed.
REVERSE RAMP #. # seconds	1.5	0.5 ÷ 10.0	Time from the current direction to reverse direction.
NEUTRAL RAMP #. # seconds	1.0	0.5 ÷ 10.0	Time from max speed to stop position.
FORWARD SPEED ### % of Supply	100	20 ÷ 100	Forward direction maximum speed (in % of battery voltage).
BACKWARD SPEED ### % of Forward	60	10 ÷ 100	Backward direction maximum speed (in % of forward direction max speed).
MINIMUM SPEED ### % of Supply	0	0 ÷ 50	Minimum speed (in % of battery voltage).
BATTERY VOLTAGE Supply ## V	24	24 ÷ 36	Battery supply voltage.
SPEED REFERENCE #####	single-ended	- ÷ -	Speed reference type.

Speed and Safety Parameters

Parameter	Default	Min ÷ Max	Description
REF. DEADBAND ### mV	50	10 ÷ 500	Potentiometer deadband.
BRAKE DELAY #. # seconds	0.5	0.0 ÷ 30.0	Braking time of the machine when the traction pedal is released.
MODE1 SPEED ### % of Supply	50	20 ÷ 100	Parameter not managed.
MODE1 CURRENT ## Amperes	45	15 ÷ 90	Parameter not managed.
BW SAFETY TIME #. # seconds	0.0	0.0 ÷ 5.0	Parameter not managed.
BW SAFETY SPEED ### % of Supply	0	0 ÷ 50	Parameter not managed.
LOW BATTERY ## Volts	19	15 ÷ 36	Low battery level.
RxI Compensation ### mV/A	0	0 ÷ 500	Motor Voltage compensation when the motor current raises.
RUN-AWAY ## Volts	14	10 ÷ 15	Machine's free-run protection.
CURRENT LIMIT ## Amperes	90	30 ÷ 90	Maximum output motor's current.
RATED CURRENT ## Amperes	25	5 ÷ 35	Motor rated current.
OVERLOAD TIME ## seconds	60	2 ÷ 60	Motor overload time.
BOOST CURRENT ### Amperes	90	15 ÷ 110	Overcurrent temporary limit (Max 10 seconds).

Input Configuration Parameters

Parameter	Default	Min ÷ Max	Description
5-J1 HW CONFIG.	N.O.	N.C. ÷ N.O.	Pin 5 – J1 hardware configuration.
6-J1 HW CONFIG.	N.C.	N.C. ÷ N.O.	Pin 6 – J1 hardware configuration.
11-J1 HW CONFIG.	N.O.	N.C. ÷ N.O.	Pin 11 – J1 hardware configuration.
2-J1 P.up-down	Pull down	P. Up ÷ P. down	Pin 2 – J1 hardware configuration.
5-J1 P.up-down	Pull down	P. Up ÷ P. down	Pin 5– J1 hardware configuration.
6-J1 P.up-down	Pull Up	P. Up ÷ P. down	Pin 6– J1 hardware configuration.
11-J1 P.up-down	Pull down	P. Up ÷ P. down	Pin 11– J1 hardware configuration.
12-J1 P.up-down	Pull down	P. Up ÷ P. down	Pin 12– J1 hardware configuration.
13-J1 P.up-down	Pull down	P. Up ÷ P. down	Pin 13– J1 hardware configuration.
SELF CUT-OFF ## minutes	0	0 ÷ 60	Time to switch Off of the machine when not used.
ENABLE ALARM 1	ENABLE	EN ÷ DIS	Alarm 1 enabling.
ENABLE ALARM 2	ENABLE	EN ÷ DIS	Alarm 2 enabling.
ENABLE ALARM 3	ENABLE	EN ÷ DIS	Alarm 3 enabling.
ENABLE ALARM 4	ENABLE	EN ÷ DIS	Alarm 4 enabling.
ENABLE ALARM 12	DISABLE	EN ÷ DIS	Alarm 12 enabling.
PASSWORD	0	0 ÷ -	Password.

5.8 Technical Features

TECHNICAL DESCRIPTION	U/M	MR
Battery compartment dimensions (l x W x h)	mm	384x520x340
Batteries Rated Voltage	V	24
Batteries Max weight	kg	136

5-56

5.9 Recommended Spare Parts

PN	Description	MR				
		60	65	75	85	100
431309	TRACTION CARD 90A 7CH4Q90N	✓	✓	✓	✓	✓
427687	RELAY CARD 24V	✓	✓	✓	✓	✓
426356	ELECTRONIC HOURMETER D=51,5 L=49	✓	✓	✓	✓	✓
210516	COMPLETE KEY SWITCH	✓	✓	✓	✓	✓
409503	SEAT MICROSWITCH	✓	✓	✓	✓	✓
409491	MICROSW.10A 3X22	✓	✓	✓	✓	✓
409249	POTENTIOMETER ABJ 2.5 KOHM	✓	✓	✓	✓	✓
409499	MICROSW. 3X22 L.C.FLAT	✓	✓	✓	✓	✓
216691	COMPLETE MICROSW. WATERPROOF	✓	✓	✓	✓	✓
222013	MICROSW. WATERPROOF ABJ 2612609 CABLATO	✓	✓	✓	✓	✓
434207	BATTERY CHARGER SPE CBHD3 24V	✓	✓	✓	✓	✓
216999	MICROSW. ABV1612613 EXTRA PRESSURE		✓	✓	✓	

Chapter 6

Mechanical Rubbing System

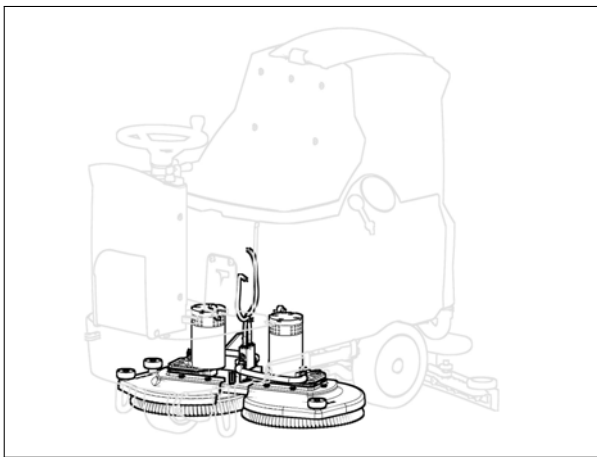

6.1 Description:

The washing function of the machine is obtained by the interaction of the cleaning solution with the dirt present on the floor.

To facilitate and enhance this interaction, is used a system of mechanical rubbing which consists in a device which rubs on the floor.

This device can be of various nature (pad or brush), in each case, its function is to mechanically remove the dirt from the ground and facilitate the reaction between the dirt and cleaning solution.

One or more direct current electric motor connected to a case of gear reduction provides the rotational movement of the brush coupling flange.

To the flange is coupled the brush (or the pad holder provided with pad) that rotates together with the flange. After lowering the brush deck to the ground, the brushes touch and rub on the floor providing the desired mechanical rubbing.

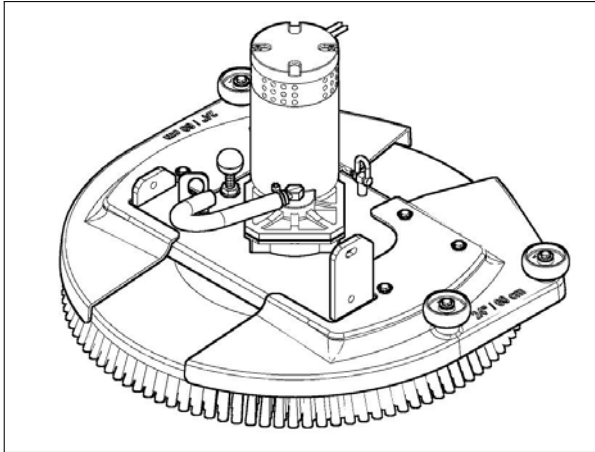

Figure 6.1: MR 60 Brush Deck

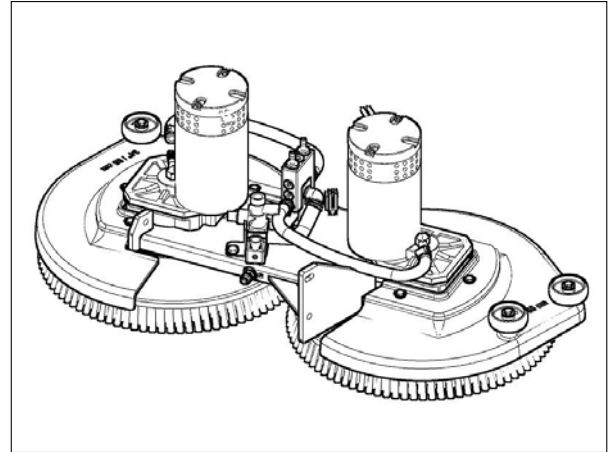

Figure 6.2: MR 65-75-85 Brush Deck

6.1.1 Structure MR 60

- Motor
- Brush Deck
- Brush coupling Flange
- Brush release lever
- Brass bushings
- Splashguard carter

6.1.2 Description MR 60:

The brush head of the 60 version is equipped with one disc brush.

It is composed from a deck on which is fixed centrally a gearmotor which threaded shaft connected to the flange and to the brush holder, provides the rotational movement.

On the plate of the deck is assembled a pin with a knob that if pressed it has the function of facilitate the release of the brush or the pad holder.

6.1.3 Structure MR 65-75-85

- Motors
- Brush Deck
- Brush coupling Flanges
- Brass bushings
- Splashguard carter

6.1.4 Description MR 65-75-85

The brush head of the 65-75-85 version is equipped with two disc counterrotating brushes with conveying to the center. **It is composed** from a deck on which are fixed two gearmotors which threaded shaft connected to the flanges, provides the rotational movement.

The brush deck, allows to change the working width by changing the position of the gearmotors in the predisposed holes.

For installation instructions see the document 10029065/ATE/AA.

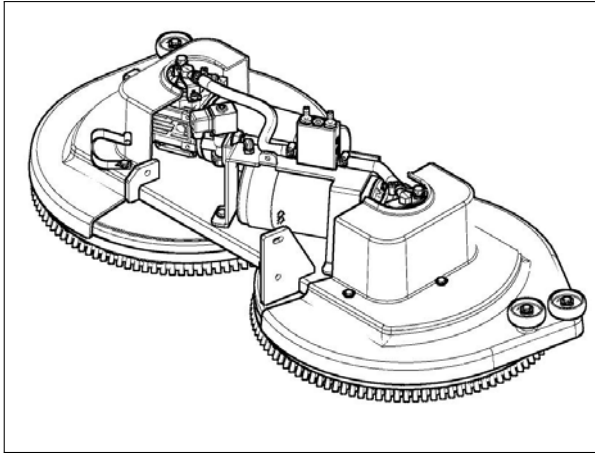

Figure 6.3: MR 100 Brush Deck

6.1.5 Structure MR 100

- Motors
- Reduction gears
- Brush Deck
- Brush coupling Flanges
- Brass bushings
- Splashguard carter

6.1.6 Description MR 100

The brush head of the 100 version is equipped with two disc counterrotating brushes with conveying to the center.

It is composed from a deck on which are fixed horizontally two motors connected to two endless screw gearboxes, which threaded shaft connected to the flanges provides the rotational movement.

6.2 Adjustments

6.2.1 Brush deck lifting cable

Adjust the lifting cable using the appropriate register on the sheath so that when the base is in the raised position the brush has a chance to pass under the base in an easy manner. In any case, the lowest part of the deck, must have a height from the ground of at least 7 cm.

6.2.2 Brush deck plate

The brush deck must be free to move pivoted to its support so that the brush acts parallel to the floor. This allows the brush to evenly lean to the ground and perform its function properly.

The deck is tilting in the transverse direction and must be adjusted inclined in the longitudinal direction compared to the machine so that the brush/es have a distance of about 3-5mm from the floor greater on the front side than on the back side. This is to make sure that during the work, the brush/es are parallel to the floor. This allows the brush/es to rest evenly on the ground and properly perform their function.

Requirements: Mounted brush/es, switched off machine.

Procedure:

- Hook the brush/es to the base.
- Loosen the screw securing the deck to the upper right support arm (see fig. 6.2.2-1).
- Interpose on the front side of the brush, between the brush itself and the floor, a spacer of about 3-5mm (see fig. 6.2.2-2).
- Lower the brush deck to the ground so that the brush/es lies uniformly and parallel to the floor.

- Tighten the fixing screw of the upper right arm.

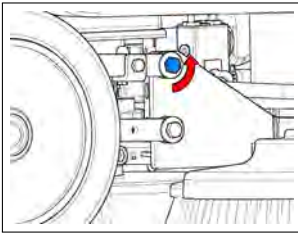

6.2.2-1

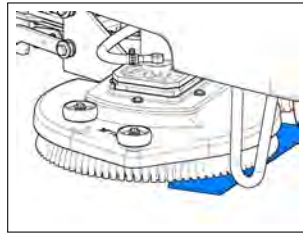

6.2.2-2

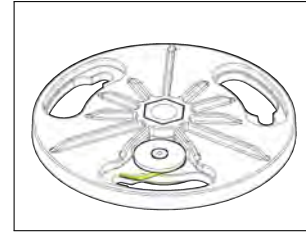

6.3.2-3

6.3.3 Motor

Check (to perform every **150h**)

Remove the brush/es.

Slightly lower the brush deck so that it **does not touch** the floor, and turn on the motor/s; the current absorption measured on the **single motor** must be less than 4 Amps (MR 60-65-75-85) and less than 7 Amps (MR 100).

The motor should rotate evenly and smoothly and doesn't have to produce unusual noises. The motor contacts have to be clean, they have not to show signs of wear or heating in general.

The motor wires insulation has to be intact in all its parts and does not show signs of cracks. The single cable have to be flexible.

The carbon brushes must be 4-6 mm long and they have not to be abnormally worn out.

Maintenance (to perform every **600h**)

Motor carbon brushes replacement

Procedure:

- Put the machine in safe conditions.
- Remove the brush deck from the machine (see section 4.2.1 at page 24).
- Loosen the screws that secure the collar brush guard.
- Disconnect the Carbon brushes from the input power line to the motor.
- Replace the carbon brushes being careful not to ruin them during assembly.

6.3 Maintenance and checks

6.3.1 Brush deck plate

Check (to perform every **150h**)

The Brush deck plate have to be kept clean and undamaged. A ruined plate can be dangerous for the machine and the operator that uses it.

If necessary, proceed to replace it.

6.3.2 Brush coupling flange

Check (to perform every **150h**)

The brush coupling flange is not subject to particular wear. Like the other components its cleanliness is essential to allow the brush to engage and disengage smoothly. It is also essential that the brush locking spring has full functionality in order to keep the brush in the correct position.

If necessary, proceed to replace it.

- Proceed to the reverse operations to reassemble it all.

6.3.4 Brass bushings

Check (to perform every **150h**)

The brass bushings allow a fluid and little tiring rotational movement of the base support arms. To prevent the base is locked in a position without the possibility of movement, is important that the brass bushings are in good condition and clean. In case of excessive wear it is necessary to proceed with the replacement.

Maintenance (to perform every **900h**)

Brass bushings replacement: *Procedure:*

- Put the machine in safe conditions.
- Lower the brush deck to the ground
- Loosen the screws that fix the arms to the brush deck
- Remove the bushings and replace them with new bushings. Sprinkle the new bushings with lubricating grease before mounting.
- Proceed to the reverse operations to reassemble it all.
- Adjust to the base once finished.

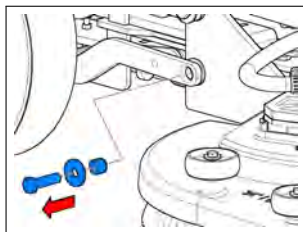

6.3.4-4

6.3.5 Lifting mechanism

Check (to perform every **150h**)

The lifting mechanism should be clean and lubricated. The lubrication of the cables must be done with silicone spray, it should not be used any grease or oil to prevent that the dirt paste itself to the classics lubricants, and lock the mechanism. The lubrication of chain must be done with lubricant grease.

6.4 Technical Features

TECHNICAL DESCRIPTION	U/M	MR				
		60	65	75	85	100
Maximum diameter of the active part of the brush/es	ϕ mm	610	650	750	850	1010
Brush turns	rpm	170	170	170	170	120
Brush motor/s voltage	V	24	24	24	24	24
Brush motors (<i>Num./Power</i>)	Nr/W	1/450	2/450	2/450	2/450	2/600
Max weight on brush	kg	30	30-60	30-60	30-60	30

6.5 Consumable Spare Parts

MR 60					
PN	Description	ϕ (mm)	Bristle	ϕ Bristle (mm)	Colour
404627	BRUSH PPL 0,3	610	PPL	0,3	Blue
405630	BRUSH PPL 0,6	610	PPL	0,6	White
405629	BRUSH PPL 0,9	610	PPL	0,9	Black
405628	BRUSH TYNEX	610	ABRASIVE	0,9	Gray
405519	PAD HOLDER	585	-	-	-
Carbon Brushes					
409412	BR.MOT.CARBON BR.	-	-	-	-

MR 65					
PN	Description	ϕ (mm)	Bristle	ϕ Bristle (mm)	Colour
422189	BRUSH PPL 0,3	340	PPL	0,3	Blue
422971	BRUSH PPL 0,6	340	PPL	0,6	White
422972	BRUSH PPL 0,9	340	PPL	0,9	Black
422981	BRUSH TYNEX	340	ABRASIVE	0,9	Gray
422973	PAD HOLDER	330	-	-	-
Carbon Brushes					
409412	BR.MOT.CARBON BR.	-	-	-	-

MR 75

PN	Description	ϕ (mm)	Bristle	ϕ Bristle (mm)	Colour
427715	BRUSH PPL 0,3	390	PPL	0,3	Blue
427716	BRUSH PPL 0,6	390	PPL	0,6	White
427717	BRUSH PPL 0,9	390	PPL	0,9	Black
427719	BRUSH TYNEX	390	ABRASIVE	0,9	Gray
427718	PAD HOLDER	380	-	-	-

Carbon Brushes

409412	BR.MOT.CARBON BR.	-	-	-	
--------	-------------------	---	---	---	--

MR 85

PN	Description	ϕ (mm)	Bristle	ϕ Bristle (mm)	Colour
430696	BRUSH PPL 0,3	430	PPL	0,3	Blue
430697	BRUSH PPL 0,6	430	PPL	0,6	White
430698	BRUSH PPL 0,9	430	PPL	0,9	Black
430699	BRUSH TYNEX	430	ABRASIVE	0,9	Gray
431122	PAD HOLDER	410	-	-	-

Carbon Brushes

409412	BR.MOT.CARBON BR.	-	-	-	
--------	-------------------	---	---	---	--

MR 100

PN	Description	ϕ (mm)	Bristle	ϕ Bristle (mm)	Colour
436310	BRUSH PPL 0,3	510	PPL	0,3	Blue
436311	BRUSH PPL 0,6	510	PPL	0,6	White
436312	BRUSH PPL 0,9	510	PPL	0,9	Black
436314	BRUSH TYNEX	510	ABRASIVE	0,9	Gray
436316	PAD HOLDER	490	-	-	-

Carbon Brushes

409420	BR.MOT.CARBON BR.	-	-	-	
--------	-------------------	---	---	---	--

6.6 Recommended Spare Parts

PN	Description	MR				
		60	65	75	85	100
428364	GEAR MOTOR 24V 400W 140RPM H2O LEFT THR.	✓	✓	✓	✓	
430830	GEAR MOTOR 24V 400W 140RPM H2O RIGHT THR.		✓	✓	✓	
407717	MOTOR 24V 600W 1800G MP80M					✓
436325	REDUCTOR NMRV-040-FD-15-71B14-18					✓
205990	BRUSH FLANGE 60	✓				
432020	RIGHT BRUSH FLANGE D=128		✓	✓	✓	✓
432021	LEFT BRUSH FLANGE D=128		✓	✓	✓	✓
209269	BUMPING WHEEL DIAM.60X21	✓	✓	✓	✓	✓

Chapter 7

Drying System

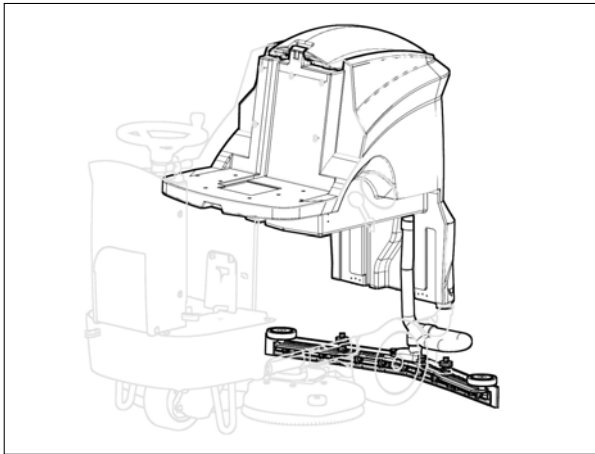

7.1 Structure

- Squeegee
- Squeegee Support
- Vacuum Hose
- Recovery Tank
- Filter and Floating
- Vacuum Motor
- Drain Hose

7.2 Description

The machine dries the floor using an integrated Drying System.

After the washing, the solution used with the mechanical action of the brush to remove the dirt, is collected by a system which vacuum it out from the floor.

The system is basically made by a vacuum motor which produces a vacuum pressure in the system. This vacuum pressure causes an air flow which flows in the whole vacuum circuit.

The air that flows in the squeegee (when it is lowered on the floor) allows it to collect the water on the floor mixing it with the water and, via the vacuum system, is brought to the recovery tank.

In the recovery tank the water mixed with the dirt stops and the air keep flowing throughout the circuit reaching the vacuum motor and being discharged in the environment.

7.3 Adjustments

7.3.1 Squeegee Support

The Squeegee Support has to be adjusted when lowered on the floor and vacuum system on. The goal of the adjustment is to let the squeegee blade be angled 45 degrees to the floor for its whole length.

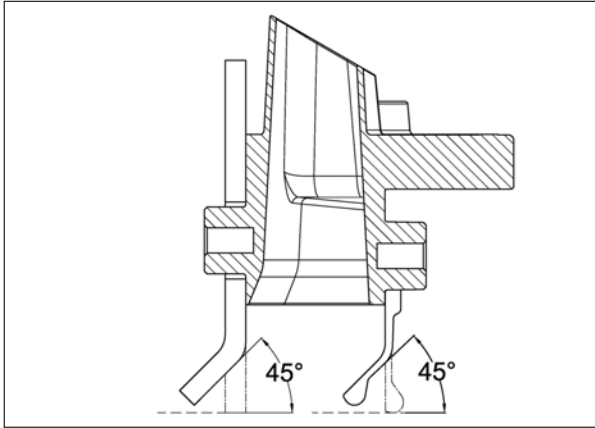

To obtain the proper squeegee adjustment act on the wheels of the squeegee support (A) to move the squeegee in the A direction and on the inclination screw (B) to adjust the B movement.

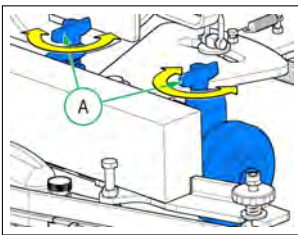

7.3.1-5

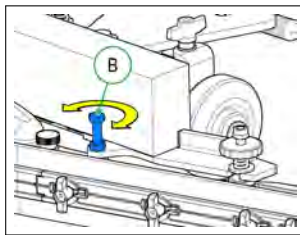

7.3.1-6

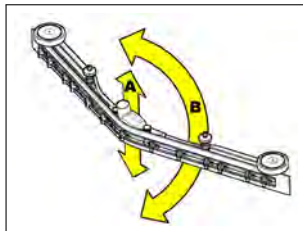

7.3.1-7

Procedure

- Lower the squeegee on the floor.
- Loosen the nuts holding the wheels of the squeegee support.
- Drive slowly pressing the accelerator pedal.
- During the advancement, adjust the squeegee support with the knobs (A) and the screw (B) so as to let the squeegee blade be angled 45 degrees to the floor for its whole length.
- Verify with a functional test the obtained adjustment.

7.3.2 Squeegee lifting cable

Adjust the squeegee lifting cable using the adjuster on the sheath so that when the squeegee is lowered to the floor, it can move laterally in all its possible excursion.

7.4 Maintenance and Checks

7.4.1 Squeegee

Check (to perform every 4h)

To have a good performance of the squeegee the blades have to be in a good conditions. The squeegee chamber and the squeegee adapter have to be clean and completely free from debris. Blades have to adhere perfectly to the squeegee body and have to be kept in that position by the plastic blade holder which are kept by the plastic wing nuts.

Maintenance (to perform every 45h)

- Put the machine in safe conditions.
- Remove the squeegee from the machine (see section 4.3.1 at page 28).
- Rotate the wing nut that block the blade holders.
- Remove the blade holder.
- Remove the front blade and replace it with a new one.
- Repeat the same operations for the rear blade. The rear blade can be used 4 times (one for each edge) before being replaced.
- Proceed at reverse to reinstall properly the blade holders.

7.4.2 Squeegee Support

Check (to perform every 150h)

The squeegee support has to be completely free to move to lie perfectly on the floor. It is important that it can rotate freely around the fixing central axle. It is also necessary that the support wheels are in perfect condition and free

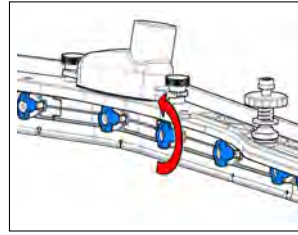

7.4.1-8

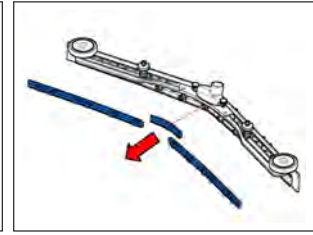

7.4.1-9

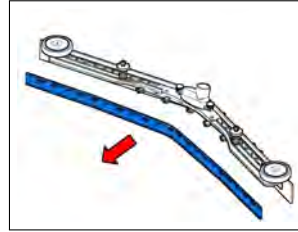

7.4.1-10

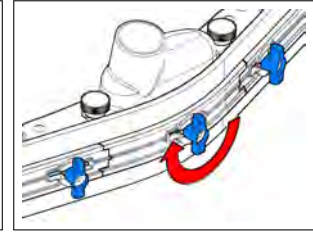

7.4.1-11

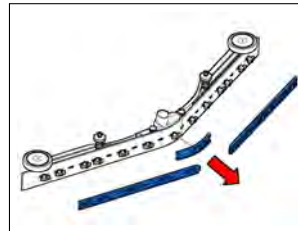

7.4.1-12

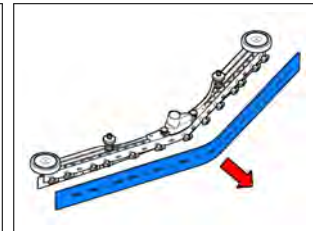

7.4.1-13

to rotate from any obstruction.

Maintenance (to perform every 600h)

- Put the machine in safe conditions.
- Remove the squeegee from the squeegee support (see section 4.3.1 at page 28).
- Completely unscrew the nuts holding the squeegee support wheels (see section 4.3.2 at page 29).
- Remove and replace the squeegee support wheels.
- Proceed at reverse to reinstall the parts.
- At the end of the assembling perform the proper squeegee adjustment (see section 7.3.1 at page 66).

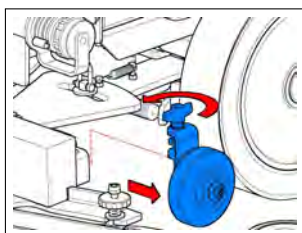

7.4.2-14

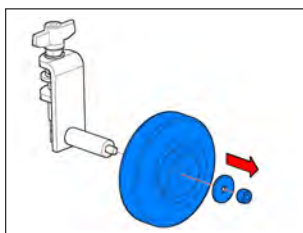

7.4.2-15



7.4.4-16

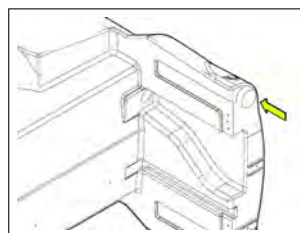

7.4.4-17

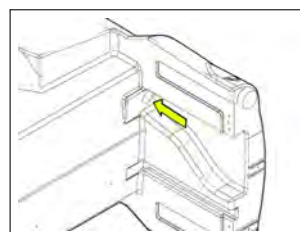

7.4.4-18

7.4.3 Vacuum Hose

Check (to perform every 4h)

The vacuum hose has to be clean and intact. It is mandatory that the hose has no crack to not decrease the vacuum pressure. The suction hose is particularly sensitive in the coupling areas between the pipe and couplings and in tight curves.

7.4.4 Recovery Tank

Check (to perform every 150h)

The recovery tank has to be clean and has not to have cracks or, in general, any kind of damage. The Lid housing has to be even and flat to allow the gasket to adhere perfectly to the tank to avoid any air infiltration. The hose fittings have to be in optimum condition in order to avoid any dirty water leakage or any pressure drop during the job.

7.4.5 Filter and Floater

Check (to perform every 4h)

The filter has to be clean and it is important that nothing blocks or reduces the floater mobility. The filter has to be clean to avoid that water or dirt goes inside the vacuum motor, the floater has to be free to move and has to block completely the air flow when it is in blocking position (UP).

Maintenance (to perform every 4h)

- Put the machine in safe conditions.
- Lift the vacuum assembly.
- Remove the filter protection cover.
- Remove the filter with floater.
- Clean (replace if necessary) the filter.
- Proceed at reverse to restore the parts.

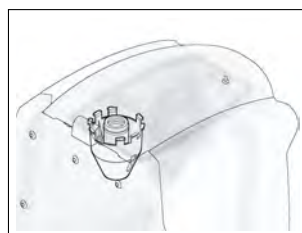

7.4.5-19

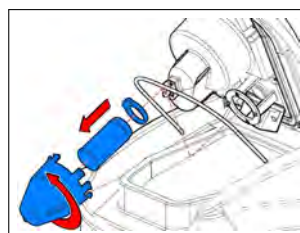

7.4.5-20

7.4.6 Vacuum Cover

Check (to perform every 4h)

The gasket inside the vacuum cover must be in good condition, clean and free from damages, to allow an optimum depression inside the recovery tank.

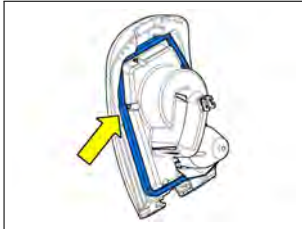

7.4.6-21

7.4.7 Vacuum Motor

Check (to perform every 150h)

The vacuum motor with the inlet completely open has to absorb less than 15 Amps.

The motor should rotate evenly and smoothly and doesn't have to produce unusual noises. The motor contacts have to be clean, they have not to show signs of wear or heating in general.

The motor wires insulation has to be intact in all its parts and does not show signs of cracks. The single cable have to be flexible.

The magnetic circuit of the motor has to be in good conditions and clean.

The carbon brushes must be 6-8 mm long and they have not to be abnormally worn out.

Maintenance (to perform every 450h)

Motor carbon brushes replacement

Procedure:

- Put the machine in safe conditions.
- Disassemble the motor from the machine (see section 4.3.11 at page 32).
- Remove the cooler fan plastic cover from the motor.

- Slip off the motor carbon brushes
- Replace the worn out carbon brushes with new ones.
- Proceed at reverse to restore the parts.

7.4.8 Drain Hose

Check (to perform every 4h)

The Drain Hose and its cap have to seal perfectly to avoid any pressure drop or dirty water leakage. The Drain Manifold has to be flexible and has to have no cracks to avoid any break down during the bending to drain the machine.



7.4.8-22

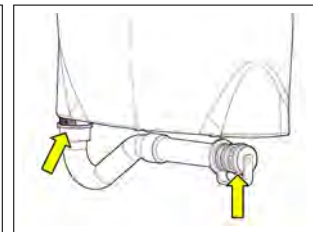

7.4.8-23

7.5 Technical Features

TECHNICAL DESCRIPTION	U/M	MR				
		60	65	75	85	100
Squeegee width	mm	800	990	990	1105	1105
Recovery Tank	l	125	125	125	125	125
Vacuum Motor Stages	Nr	2	2	2	2	2
Vacuum Motor Voltage	V	24	24	24	24	24
Vacuum Motor Power	W	310	310	310	310	310
Vacuum Motor Depression	<i>mmH₂O</i>	700	700	700	700	700

7.6 Consumable Spare Parts

7-70

PN	Description	MR				
		60	65	75	85	100
219454	RUBBER KIT 33 SHORE	✓				
219455	RUBBER KIT 40 SHORE POLIURETANO	✓				
219456	LATEX RUBBER KIT	✓				
219457	RUBBER KIT 33 SHORE		✓	✓		
219458	RUBBER KIT 40 SHORE POLIURETANO		✓	✓		
219459	LATEX RUBBER KIT		✓	✓		
219460	RUBBER KIT 33 SHORE				✓	✓
219461	RUBBER KIT 40 SHORE POLIURETANO				✓	✓
219462	LATEX RUBBER KIT				✓	✓
405689	WHEEL DIAM.100X30 GRAY	✓	✓	✓	✓	✓
Carbon Brushes						
424210	VACUUM MOTOR CARBON BRUSHES	✓	✓	✓	✓	✓

7.7 Recommended Spare Parts

PN	Description
219723	VACUUM MOTOR 24V 310W H950 2ST
432091	VACUUM HOSE 38X1080
431081	DRAIN HOSE D.38X595 D.50 W/CAP
430957	STRAIGHT OPENING D=40
436120	BUMPER WHEEL D=100 H=20

Chapter 8

Machine Frame and Traction System

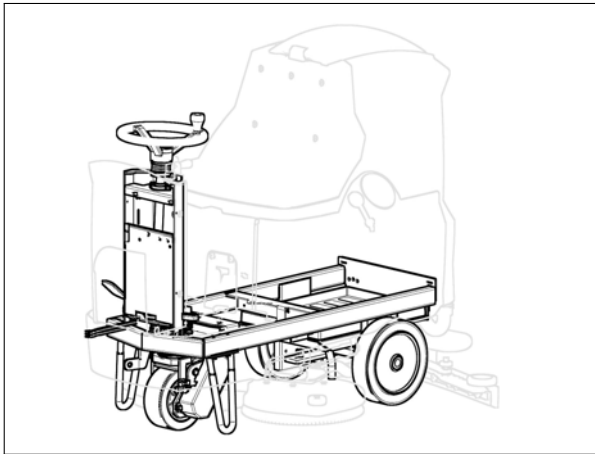

8.1 Structure

- Squeegee and Brushdeck Levers
- Steering column
- Front Wheel
- Traction Motor
- Rear Wheels
- Brake

8.2 Description

The frame is a unique structure in painted steel.

On it are coupled the steering system including the levers for the activation of the drying system and mechanical friction system, and the traction system.

The steering system is composed by a steering column connected to a steering wheel, which acts directly on the front wheel. The steering is ensured by a pinion and a sprocket, connected by a chain.

The pinion is welded directly onto the steering, while the sprocket is installed on the assembly front wheel.

On top of the steering column, there are the levers for the activation of the squeegee and the mechanical friction system.

To ensure the proper functioning of the two systems, in the steering column are installed some microswitches that act directly on the affected systems.

The traction of the machine is guaranteed by an electric motor installed in combination with a gear and a chain, whose output shafts act directly on the front wheel of the machine, ensuring traction.

Both the front wheel the rear wheels are **non-marking** and **antiskid**.

8.3 Adjustments

8.3.1 Steering wheel

The steering wheel should be adjusted when there is too much clearance between the chain that acts on the pinion connected to the steering bar of the steering wheel and the sprocket mounted on the front wheel.

Procedure

- Put the machine in safe conditions.
- Remove the steering wheel cover.
- Loosen the nuts securing the bottom support plate of the steering shaft.
- Release the grains locking nuts, set the optimum tension of the chain by acting on the grains, lock the adjustment by tightening the locking nuts.
- Once found the optimum tension tighten the fixing nuts to lock the bottom supporting plate of the steering shaft.
- Restore the steering wheel cover.

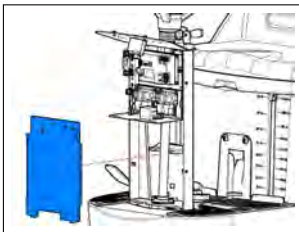

8.3.1-24

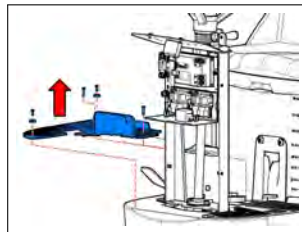

8.3.1-25

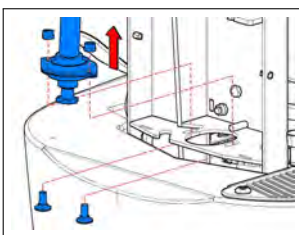

8.3.1-26

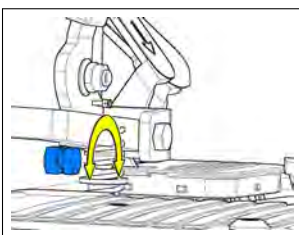

8.3.1-27

8.3.2 Brake

The brake must be adjusted when the braking is no longer effective. The adjustment have to be performed by giving more or less pressure on the plate that presses on the front wheel, acting as a brake.

Procedure

- Put the machine in safe conditions.
- Remove the right footrest.
- Adjust the height of the brake plate, acting on the adjusting screw. **IMPORTANT:** The plate must be adjusted so that when not pressed, it doesn't touch the front wheel at all.
- Restore the right footrest.

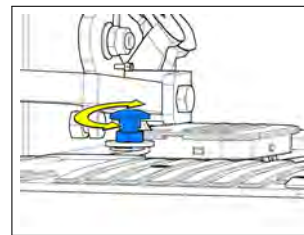

8.3.2-28

8.3.3 Motorwheel Chain

The Motorwheel chain should be adjusted when there is too much clearance between the chain that acts on the pinion connected to the front wheel and the pinion that is coupled to the motorwheel. The adjustment must be done by giving the proper chain tension.

Procedure

- Put the machine in safe conditions.
- Remove the motorwheel protection cover.

- Loosen the screws A, B, and the locknut C.
- Tighten or loosen the screw D to respectively tighten or loosen the chain.
- With a functional check, verify that the chain is not noisy and is properly tight.
- Tighten the screws A, B and the locknut C to secure the adjustment.
- Restore the motorwheel protection cover. **IMPORTANT:** Pay attention to the spacers on the cover.
- Lower the squeegee and the brush deck to the floor.
- Unscrew the screws that hold the levers to the steering column and remove the internal levers.
- Proceed with the removal of the bushings and replace them with new bushings.
- Restore the steering wheel cover.

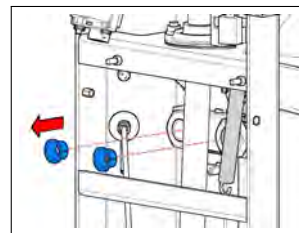
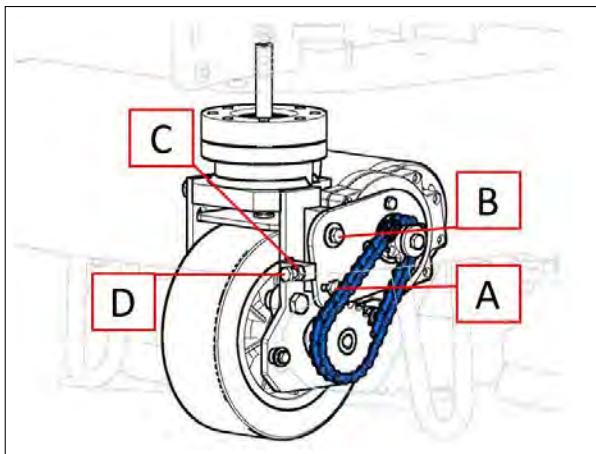

8.4.1-29

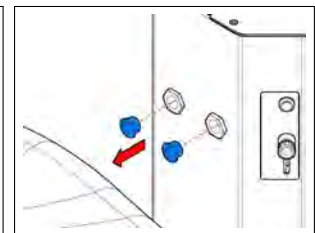

8.4.1-30

8.4 Maintenance and Checks

8.4.1 Levers

Check (to perform every 150h)

The operating levers of the squeegee and the brush deck, must always be operated with ease and without excessive effort from the operator.

Maintenance (to perform every 600h)

Replacement of the brass laminated bushings:

- Put the machine in safe conditions.
- Remove the steering wheel cover.

8.4.2 Steering

Check (to perform every 150h)

The steering must always be precise and free to rotate smoothly. Check that the ring and the pinion coupling chain has no excessive clearance and is not noisy.

Maintenance (to perform every 600h)

Periodically grease the ring and pinion coupling chain. If the chain is too loose, adjust the chain tension as described in the "Settings" paragraph.

8.4.3 Front Wheel

Check (to perform every **150h**)

The wheel must be free to rotate smoothly without friction. The wheel surface, must always be in good condition.

Maintenance (to perform every **600h**)

Periodically check the wheel bearings status. Periodically grease the wheel bearings.

8.4.4 Traction motor

Check (to perform every **150h**)

With the drive wheel lifted from the floor, the current absorption must be less than 5 Amps.

ATTENTION – At the start and when accelerating the absorption current of the motor is much higher.

The motor should rotate evenly and smoothly and doesn't have to produce unusual noises. The motor contacts have to be clean, they have not to show signs of wear or heating in general.

The motor wires insulation has to be intact in all its parts and does not show signs of cracks. The single cable have to be flexible.

The carbon brushes must be 4-6 mm long and they have not to be abnormally worn out.

Maintenance (to perform every **600h**)

Motor carbon brushes replacement

Procedure:

- Put the machine in safe conditions.
- Loosen the screws that secure the collar brush guard.
- Disconnect the carbon brushes from the electrical connection to the motor.

- Replace the carbon brushes being careful not to ruin them during assembly.

- Proceed to reverse operations for re-assembly.

8.4.5 Rear Wheels

Check (to perform every **150h**)

The wheels must be free to rotate smoothly without friction. The wheel surface must always be in good condition.

8.4.6 Brake

Check (to perform every **150h**)

The brake pedal have to be easily pushable. The locking lever of the brake pedal have to be easy to engage. With the parking brake released, the plate doesn't have to touch the front wheel. If the plate touches the front wheel, adjust its height as described in the "Settings" paragraph

8.5 Technical Features

TECHNICAL DESCRIPTION	U/M	MR
Traction motor Voltage	V	24
Traction motor Power	W	400
Maximum forward speed	km/h	6.0
Maximum reverse speed	km/h	3.6 (Default)
Traction wheel <i>(num/diam/width)</i>	Nr/ ϕ mm/mm	1/220/80
Rear wheels <i>(num/diam/width)</i>	Nr/ ϕ mm/mm	2/300/70
Wheels material		Thermoplastic Polyurethane
Wheel hardness	Sh	85

8.6 Consumable Spare Parts

PN	Description
430857	FRONT WHEEL D=220 S=80
430836	REAR WHEEL D=300 S=70
Carbon Brushes	
422462	TR. MOTOR CARBON BRUSHES

8.7 Recommended Spare Parts

PN	Description
212394	TRACTION MOTOR 24V 400W 240G IP20 MRP6

Chapter 9

Cleaning Solution Supply System

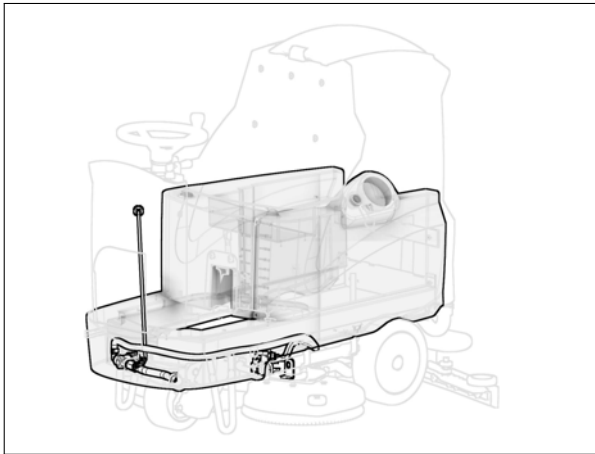

9-76

9.1 Structure

- Solution Tank
- Hoses
- Water Valve
- Solution Filter
- Solenoid Valve
- Distributor

9.2 Description:

The Cleaning Solution Supply System is made by a tank commonly called solution tank or clean water tank.

In this tank the clean water is mixed with the detergent to create the cleaning solution that the machine will use to clean.

The solution is then canalized to the filter and the water valve.

The filter is used to stop debris that could stuck the hose system and compromise the proper functioning of the system, **the water valve** is used to adjust the solution that will fall on the floor in order to have the correct amount of solution required for washing.

The water valve is placed upstream of the filter to allow the filter cleaning even with fully or partially full solution tank.

Once passed through the water valve the solution arrive to the solenoid valve that blocks the delivery when the brush is not working and allow the flow while brush works.

The end of the solution path is the distributor that canalizes the flow in the middle of the brush.

The solution tank is also equipped with a drain hose to empty it in case of need.

9.3 Maintenance and 9.3.3 Water Valve Checks

9.3.1 Solution Tank

Check (to perform every 50h)

The solution tank has to be clean and intact. It has not to have cracks or any other kind of damage. Verify, when the tank is completely filled up, that there are not leakage. If necessary replace the Solution Tank.

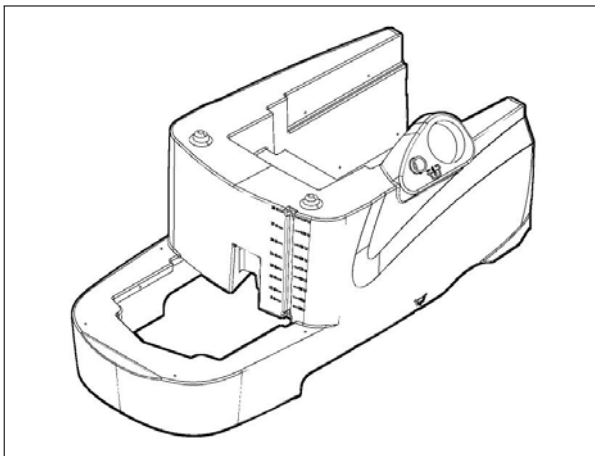

9.3.2 Hoses

Check (to perform every 50h)

Every single hose has to be intact and has not to be worn out. It is extremely important that the hoses kept the original flexibility and they haven't suffered any chemical reaction with the detergent used with the machine. If necessary proceed with the replacement of the damaged hoses.

Check (to perform every 50h)

It is extremely important that when adjusted at minimum the valve blocks completely the water flow and that the adjustment lever is mechanically free to move for its whole stroke.

9.3.4 Clean Water Filter

Check (to perform every 4h)

The filter has to be periodically cleaned. When it is fitted on the machine no leakage has to be present. The filter cartridge has to be intact and has not to present any anomaly.

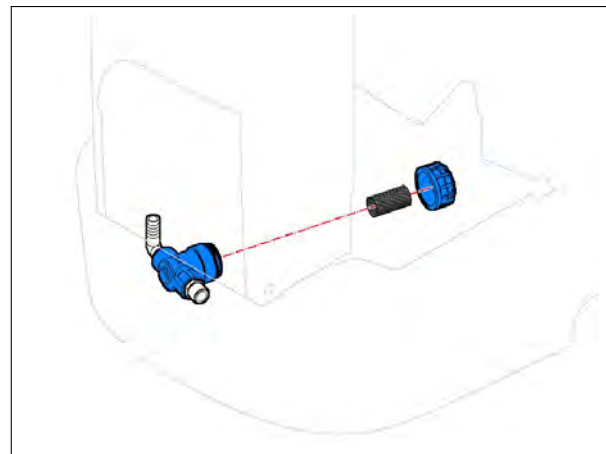

9.3.5 Solenoid Valve

Check (to perform every **50h**)

The solenoid valve has to block completely the solution flow when the brush deck is not working. Viceversa it has to grant the full flow rate when the brush deck is working.

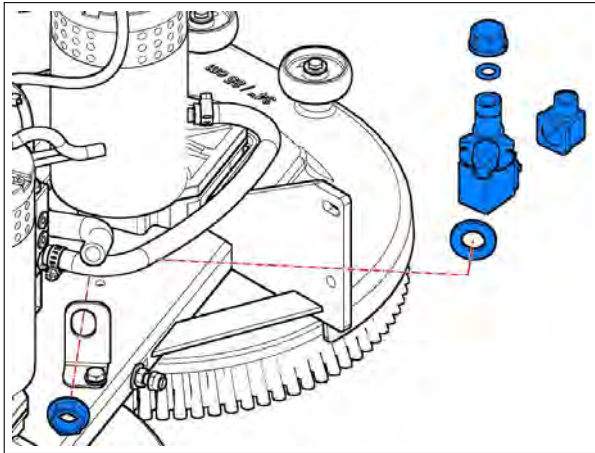

9.3.6 Distributor

Check (to perform every **150h**)

The distributor must be intact and must allow full passage of solution without losses in the gearbox of the motor brushes. The amount of water distributed in the two brushes versions, must be the same on both brushes.

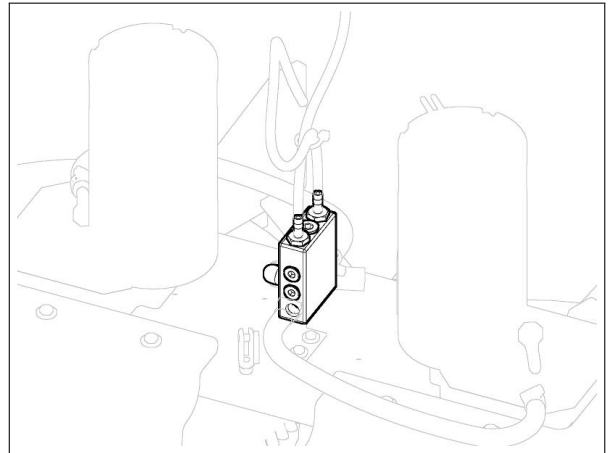

9.4 Technical Features

TECHNICAL DESCRIPTION	U/M	MR
Solution Tank	1	110
Clean Water Filter		Steel cartridge
Water Valve		Steel ball valve

9.5 Recommended Spare Parts

PN	Description
407887	COMPLETE SOLENOID 24V 1/2" ACL 3
212616	CLEAN WATER FILTER 1/2" F/F COMPL.
420950	GASKET OR 2X38 MM

Part IV

Accessories and Add-On

9-80

Chapter 10

Accessories

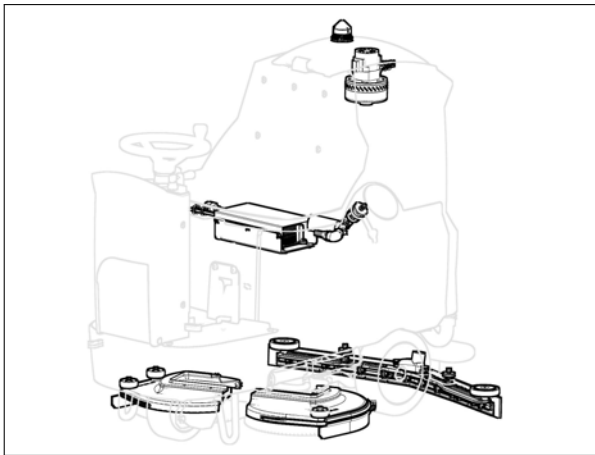

10.1 Accessories List

- Blinking Kit
- On-board Charger Kit
- Fast Filling Kit
- 3 Stages Vacuum Motor Kit
- Splashguard Kit w/rubbers
- Plastic squeegee Kit

10.2 Blinking Kit - 221648

10.2.1 Description

The kit consists of a signal flashing yellow light. Although this light is not considered mandatory by law, if the user requires it for their particular needs is possible to equip the machine with this accessory.

10.2.2 Machine Preparation

Before to start the kit installation it is mandatory to put the machine in safe condition. Release the brush, switch off the machine and unplug the batteries.

10.2.3 Installing instructions

- Unplug the power cable of the batteries.
- Open the vacuum cover and remove the screws (six) that secure the vacuum motor carter to the vacuum cover (five screws are easily visible, while the sixth screw is positioned near the water conveyor) (see fig. 10.2.3-31).
- Remove the cover and cut the band that secures the electrical wiring of the motor (see fig. 10.2.3-32) (see fig. 10.2.3-33).
- Remove the Flashing Kit wire harness sheath to find a blue and a brown wire.



10.2.3-31



10.2.3-32



10.2.3-33



10.2.3-34

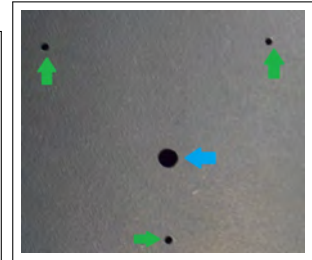

10.2.3-35

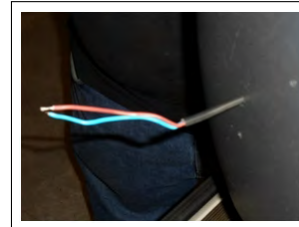

10.2.3-36

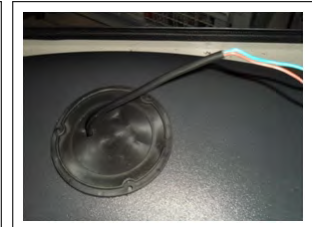

10.2.3-37



10.2.3-38



10.2.3-39

- Place the rubber base that came with the kit to the center of the suction cap and proceed to perform three holes for the blinker support fixing screws (see fig. 10.2.3-34) (see fig. 10.2.3-35). In the same way drill the holes of the cover for the power cables of the blinker (see fig. 10.2.3-36).
- Pass the power cables of the blinker through the center hole drilled in the vacuum cover, place the rubber base of the cap Flashing Kit on the cover (see fig. 10.2.3-37).
- Place the blinker on the vacuum cover and connect the brown wire to the slot number 1 and the blue wire to the slot number 3 of the power connector (see fig. 10.2.3-38).
- Fasten the blinker to the vacuum cover by means of the three screws (see fig. 10.2.3-39).
- Restore the vacuum cover attaching the carter to the cover with the six

screws.

- Reconnect the battery cables and proceed to a functional check of the machine.

10.3 Onboard Charger Kit - 219613

10.3.1 Description

The machine is available in "CB" version which is the version with the built in charger. Anyway, in a standard machine, the battery charger can be fitted acting as follows.

10.3.2 Machine Preparation

Before to start the kit installation it is mandatory to put the machine in safe condition. Switch off the machine and unplug the batteries.

10.3.3 Installing instructions

- Unplug the power cable of the batteries.
- Collect the cables coming from the charger in a beam, with the exception of the power cord, and insert them within the heatshrinkable sheath as shown in figure (see fig. 10.3.3-40).
- Assemble the rubber protection to the support of the charger by applying the plastic black rivets (see fig. 10.3.3-41).
- Attach the charger to the adaptation bracket/support (see fig. 10.3.3-42) (see fig. 10.3.3-43).



10.3.3-40

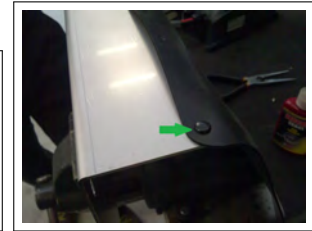

10.3.3-41



10.3.3-42



10.3.3-43



10.3.3-44

- Attach the battery charger and its support bracket into the slot on the machine as shown in the figure (see fig. 10.3.3-45) (see fig. 10.3.3-46) (see fig. 10.3.3-47).
- Slide the power supply cables of the charger to the side of the solution tank until it meets the predisposition of the electrical wiring near the scrub deck (see fig. 10.3.3-48).
- Connect the power cord to the electrical wiring of the machine as shown in figure (see fig. 10.3.3-49) (see fig. 10.3.3-50) (see fig. 10.3.3-51).
- Reconnect the battery cables and proceed to a functional check of the machine.

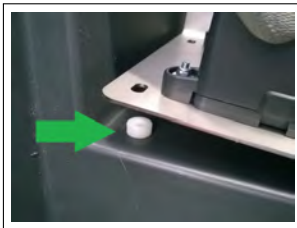

10.3.3-45

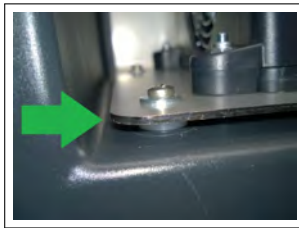

10.3.3-46



10.3.3-47



10.3.3-48

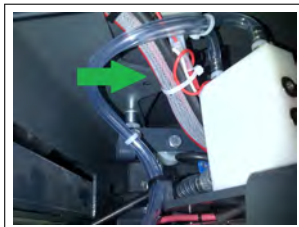

10.3.3-49

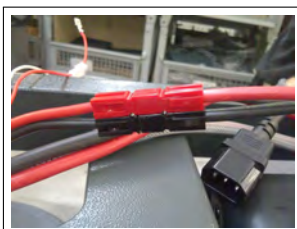

10.3.3-50

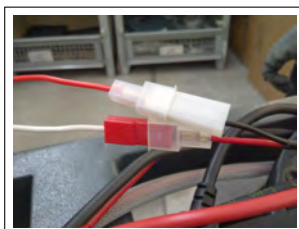

10.3.3-51

10.4 Fast Filling Kit - 219464

10.4.1 Description

In order to optimize the filling procedure of the solution tank it is now available a rapid filling kit as an optional.

10.4.2 Machine Preparation

Before to start the fast filling kit installation it is mandatory to put the machine in safe condition. Switch off the machine and unplug the batteries.

10.4.3 Installing instructions

- Unplug the power cable of the batteries.
- Remove the hose retainer cap from the solution tank.
- Remove the filter and tank cap from the solution tank (see fig. 10.4.3-53).



10.4.3-52



10.4.3-53

- Loose the brass fitting from the kit (see fig. 10.4.3-54).
- Put on the brass fitting thread some sealer liquid (see fig. 10.4.3-55).
- Put the kit FFF in tank as shown in the picture (see fig. 10.4.3-56).
- Put the black plastic fitting just below the hose retainer hole (see fig. 10.4.3-57).
- Screw up the brass fitting to the black plastic fitting tightly.
- Put back the filter and the cap on the solution tank (see fig. 10.4.3-58) (see fig. 10.4.3-59).

10.5 3 Stages Vacuum Motor Kit - 219646

10.5.1 Description

In order to reduce the noise of the vacuum motor in working conditions and to optimize the performance of the machine it is possible to use a 3-stage vacuum motor of 650 watts power.



10.4.3-54



10.4.3-55



10.4.3-56



10.4.3-57



10.4.3-58



10.4.3-59

10.5.2 Machine Preparation

Before to start the 3-stage vacuum motor installation it is mandatory to put the machine in safe condition. Switch off the machine and unplug the batteries.

10.5.3 Installing instructions

- Unplug the power cable of the batteries.
- Remove the vacuum motor by its COVER (see section 4.3.11 at page 32).
- Position the new motor in the vacuum cover.
- Assemble again the vacuum cover.
- Reconnect the battery cables and proceed to a functional check of the machine.

10.6 Splashguard Kit w/rubbers, MR65(221973), MR75(221974), MR85(221975)

10.6.1 Description

Even if the solution output is in the middle of the brush, on particular not absorbing kind of floors could be necessary a Splashguard in order to avoid the dispersing of the solution outside of the scrubbing path. The Functioning of this kit is absolutely equal to the other ones similar to it.

10.6.2 Machine Preparation

Before to start the splashguard kit w/rubbers installation it is mandatory to put the machine in safe condition. Switch off the machine, unplug the batteries and uncouple the brushes.

10.6.3 Installing instructions

- Unplug the power cable of the batteries.
- Remove the protective carters fixed to the scrub deck by turning the screws (four screws for each carter) (see fig. 10.6.3-60) (see fig. 10.6.3-62).
- Position the carter with the rubbers supplied with the kit fixing the four mounting screws (see fig. 10.6.3-61) (see fig. 10.6.3-63).
- Couple the brushes, reconnect the battery cables and proceed to a functional check of the machine.

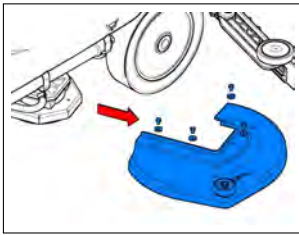

10.6.3-60

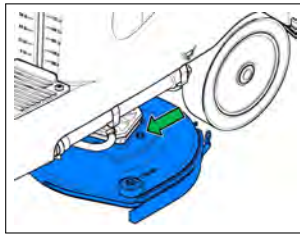

10.6.3-61

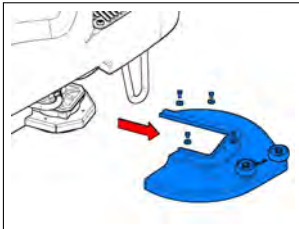

10.6.3-62

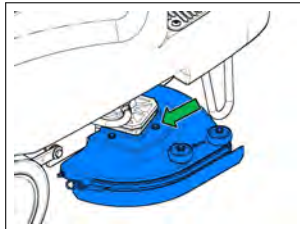

10.6.3-63

- Check the adjustment of the squeegee support.

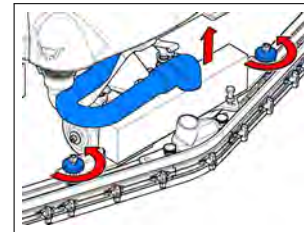

10.7.3-64

10.7 Plastic squeegee Kit, MR65-75(219381), MR85-100(219382)

10.7.1 Description

For the 2 brushes models only, it is available also the complete squeegee assembly with plastic body.

10.7.2 Machine Preparation

Before to start the plastic squeegee installation it is mandatory to put the machine in safe condition. Switch off the machine and unplug the batteries.

10.7.3 Installing instructions

- Put the machine in safe conditions.
- Unplug the Vacuum Hose.
- Loose the knobs that block the Squeegee to the Squeegee Support (see fig. 10.7.3-64).
- Move the squeegee sideways to release it from the squeegee support.
- Proceed at reverse to install the plastic squeegee.

10.8 Consumable Spare Parts

PN	Description	MR				
		60	65	75	85	100
435437	SPLASHGUARD RUBBER L=400		✓	✓	✓	
435438	SPLASHGUARD RUBBER L=500			✓		
219457	RUBBER KIT 33 SHORE		✓	✓		
219460	RUBBER KIT 33 SHORE				✓	✓
405689	WHEELDIAM.100X30 GRAY		✓	✓	✓	✓
Carbon Brushes						
409409	3-ST. VAC. MOTOR CARBON BRUSHES	✓	✓	✓	✓	✓

10.9 Recommended Spare Parts

PN	Description	MR				
		60	65	75	85	100
430957	STRAIGHT OPENING D=40		✓	✓	✓	✓
436120	BUMPER WHEEL D=100 H=20		✓	✓	✓	✓



10-88

Fimap S.p.A.
Workshop Handbook MR

Fimap S.p.A. Via Invalidi del Lavoro, 1 - 37050 S.Maria di Zevio Verona - ITALY
Tel. +39 045 6060411 - Fax +39 045 6060417
Edition: July 24, 2014