

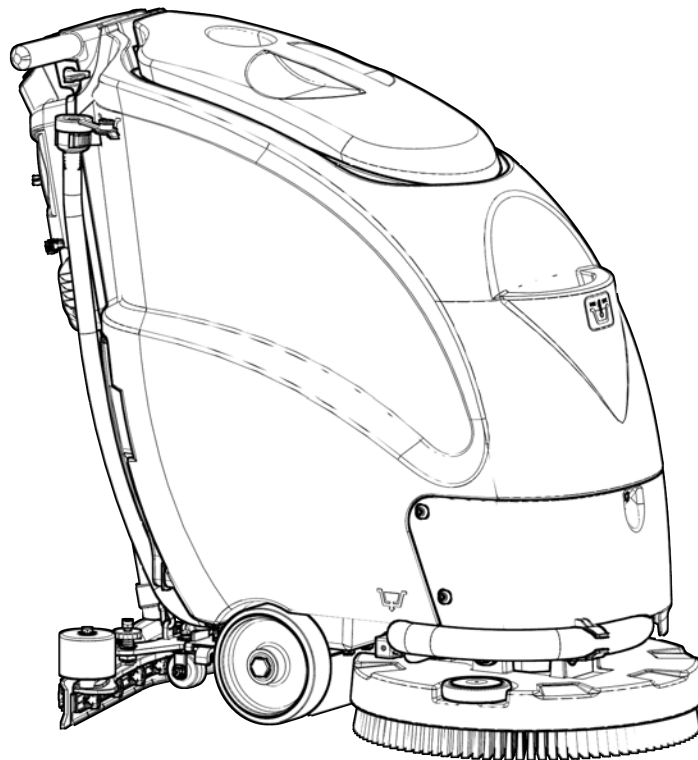

WORKSHOP HANDBOOK

My50



Version: **AA**

Date: **September 29, 2014**

Document Number: **10050486**

ATTENTION

This document is valid starting from serial number:

214009154

Contents

I	Product Introduction	4
1	Serial Number and Technical Support	5
1.1	The Serial Tag	5
1.2	Serial Tag location	5
2	Main Technical Features	6
II	Anomalies Resolution Guide	7
3	Trouble-shooting for the most common anomalies.	8
3.1	Electrical system: what to do if.	8
3.2	Mechanical scrubbing system: what to do if.	10
3.3	Drying system: what to do if.	11
3.4	Frame and traction system: what to do if.	13
3.5	Solution delivery system: what to do if.	14
4	Disassembling Procedures	15
4.1	Electrical Installation	16
4.2	Mechanical Friction System	20
4.3	Drying System	22
4.4	Frame and Traction System	27
4.5	Solution Delivery System	27
III	Machine Description	29
5	Electrical System	30
5.1	Structure	30
5.2	Description	30
5.3	Location of Electrical components	31
5.4	Operator Lever Microswitches	33
5.5	Hourmeter	33
5.6	Charger	33
5.7	Batteries	33
5.8	Adjustments	34
5.9	Maintenance and Checks	36
5.10	Technical Features	37
5.11	Recommended Spare Parts	37

6	Mechanical Rubbing System	38
6.1	Structure	38
6.2	Description	38
6.3	Adjustments	39
6.4	Maintenance and checks	39
6.5	Technical Features	42
6.6	Consumable Spare Parts	42
6.7	Recommended Spare parts	42
7	Drying System	43
7.1	Structure	43
7.2	Description	43
7.3	Adjustments	44
7.4	Maintenance and Checks	44
7.5	Technical Features	48
7.6	Consumable Spare Parts	48
7.7	Recommended Spare Parts	48
8	Machine Frame and Traction System	49
8.1	Structure	49
8.2	Description	49
8.3	Maintenance and Checks	49
8.4	Technical Features	50
8.5	Consumable Spare Parts	50
9	Cleaning Solution Supply System	51
9.1	Structure	51
9.2	Description	51
9.3	Maintenance and Checks	52
9.4	Technical Features	54
9.5	Recommended Spare Parts	54
IV	Accessories and Add-On	55
10	Accessories	56
10.1	Accessories List	56
10.2	Onboard Charger Kit - 220851	56

Part I

Product Introduction

Chapter 1

Serial Number and Technical Support

1.1 The Serial Tag

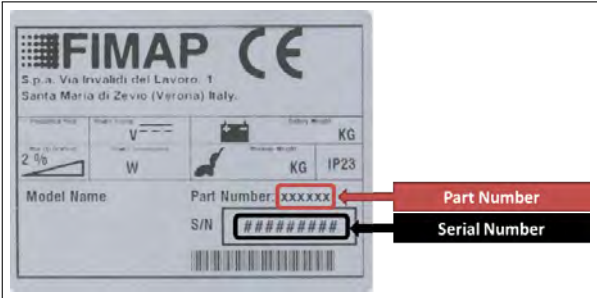

1.2 Serial Tag location

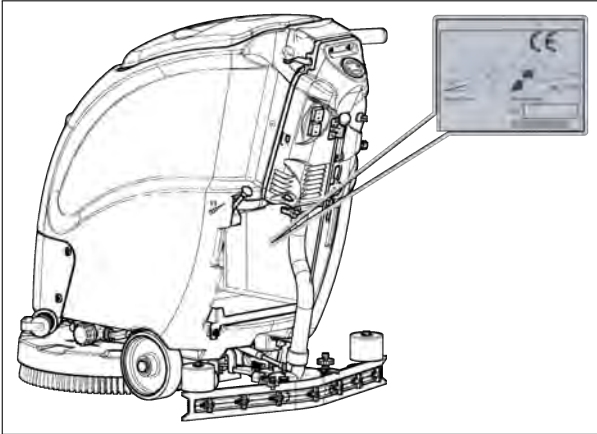

The serial tag is located inside the battery compartment. The Serial Number is an extremely important information which has to be provided each time a Technical Support is required or is necessary to buy spare parts or accessories. The serial number is the only way to identify the machine by model, production date type equipments in general.

Chapter 2

Main Technical Features

Technical Data

TECHNICAL DESCRIPTION	U/M	My50 B
Working width	mm	508
Working capacity, up to	$\frac{m^2}{h}$	1450
Maximum Ramp Gradient	%	2
Steering Diameter	mm	1200
Total power	W	810
Machine Length	mm	1125
Machine Height	mm	995
Machine Width <i>(without squeegee)</i>	mm	525
Machine Width <i>(with squeegee)</i>	mm	680
Machine Width <i>(with optional squeegee)</i>	mm	780
Sound pressure level <i>(ISO 11201)</i>	LpA dB (A)	52.9
Hand vibration level <i>(ISO 5349)</i>	$\frac{m}{s^2}$	≤ 0.66

Weights and Pressures¹

TECHNICAL DESCRIPTION	U/M	My50 B
Machine Weight <i>(empty and without batteries)</i>	kg	61.50
Machine Gross Weight, work condition <i>(machine + batteries + water)</i>	kg	152.00
Weight on front right wheel	kg	51.00 ÷ 71.50
Weight on front left wheel	kg	49.00 ÷ 71.00
Weight on rear wheel	kg	29.00 ÷ 51.00

¹Weight and Pressures depends on how much water there is in the tank and on the battery type.

Part II

Anomalies Resolution Guide

Chapter 3

Trouble-shooting for the most common anomalies.

3.1 Electrical system: what to do if...

The machine doesn't switch on

- | | | |
|--|---|---|
| 1) The main switch is in position 0 | ⇒ | <i>Push the main switch in position I.</i> |
| 2) The main switch is not properly connected | ⇒ | <i>Restore the proper connections.</i> |
| 3) The main switch doesn't work | ⇒ | <i>Replace the main switch (see section 4.1.5 at page 17).</i> |
| 4) The machine is not powered properly | ⇒ | <i>Refer to the proper section (see section 3.1 at page 9).</i> |
-

The machine has a very limited working autonomy

- | | | |
|---|---|---|
| 1) The BDI (Battery Discharge Indicator) is not properly adjusted | ⇒ | <i>Verify the type of battery used on the machine and adjust properly the BDI (see section 5.8.2 at page 34).</i> |
| 2) Batteries have been working for several cycles | ⇒ | <i>Replace the batteries.</i> |
-

The batteries don't work properly

- | | | |
|--|---|--|
| 1) The batteries are not properly connected | ⇒ | <i>Restore the proper battery connections.</i> |
| 2) Battery are discharged | ⇒ | <i>Perform a complete charge cycle.</i> |
| 3) Battery terminal are oxidized | ⇒ | <i>Disconnect the batteries, clean the batteries terminals and reconnect properly the batteries.</i> |
| 4) With the machine in working conditions one battery has a voltage lower (difference higher than 2 V) than the other ones | ⇒ | <i>Replace the battery with lower voltage.</i> |
| 5) The power wires are damaged | ⇒ | <i>Replace the damaged wires.</i> |
| 6) The battery charger is not properly adjusted | ⇒ | <i>Adjust properly the battery charger (see section 5.8.3 at page 35).</i> |
| 7) The battery charger doesn't work | ⇒ | <i>Check the proper section (see section 3.1 at page 9).</i> |
-

The battery charger doesn't work

- | | | |
|---|---|--|
| 1) The battery charger is not connected to the power supply | ⇒ | <i>Connect the charger to a supplied electric socket.</i> |
| 2) The battery charger is not connected to the batteries | ⇒ | <i>Connect the charger to the batteries.</i> |
| 3) The battery charger has one or more lights (or LEDs) blinking continuously | ⇒ | <i>The battery charger is in error conditions, verify the alarm tables and solve the issue by following the related instructions (see section 5.8.3 at page 36).</i> |
| 4) The battery charger is properly connected but it doesn't switch on | ⇒ | <i>Replace the battery charger.</i> |
-

3.2 Mechanical scrubbing system: what to do if...

The machine doesn't clean well

1)	The machine is switched off	⇒	<i>Switch on the machine.</i>
2)	The machine doesn't switch on	⇒	<i>Refer to the proper section (see section 3.1 at page 8).</i>
3)	The dead man switch doesn't work	⇒	<i>Replace the dead man switch (see section 4.1.8 at page 18).</i>
4)	The brush deck motor is not supplied	⇒	<i>Verify the motor connections.</i>
5)	The carbon brushes are worn out	⇒	<i>Replace the carbon brushes (see section 6.4.1 at page 39).</i>
6)	The brush motor is supplied but it doesn't work	⇒	<i>Replace the motor (see section 4.2.4 at page 21).</i>
7)	The brush rotates in opposite way	⇒	<i>Check the motor connections.</i>
8)	The brushdeck is lifted from the floor	⇒	<i>Tilt down the machine to let the brush touch the floor.</i>
9)	The brush is not properly engaged	⇒	<i>Release and engage properly the brush.</i>
10)	The solution flow rate is not correct or not enough	⇒	<i>Refer to the proper section (see section 3.5 at page 14).</i>

3.3 Drying system: what to do if...

The machine doesn't dry well

1)	The machine is switched off	⇒	Switch on the machine.
2)	The machine doesn't switch on	⇒	Refer to the proper section (see section 3.1 at page 8).
3)	The recovery compartment of the tank is full	⇒	Empty the recovery compartment following the proper procedure.
4)	The vacuum motor doesn't switch on	⇒	Refer to the proper section (see section 3.3 at page 12).
5)	The squeegee is lifted up from the floor	⇒	Lower the squeegee.
6)	The squeegee rubber blades are worn out or broken	⇒	Rotate or replace the squeegee rubber blades (see section 7.4.1 at page 44).
7)	The squeegee is not properly adjusted	⇒	Adjust the squeegee properly following the proper procedure (see section 7.3.1 at page 44).
8)	The squeegee vacuum chamber is stuck or dirty	⇒	Clean the squeegee vacuum chamber.
9)	The squeegee adapter is stuck or dirty	⇒	Clean the squeegee adapter.
10)	The vacuum hose is stuck or broken	⇒	Clean or replace the vacuum hose.
11)	The vacuum hose is not properly fitted in	⇒	Connect the vacuum hose properly.
12)	The intake manifold is stuck or broken	⇒	Clean or replace the intake manifold.
13)	The intake manifold is not properly connected	⇒	Connect the intake manifold properly.
14)	The vacuum filter is dirty or stuck	⇒	Disassemble and clean the vacuum filter (see section 4.3.8 at page 25).
15)	The vacuum cover is not well positioned or is missing	⇒	Position properly the vacuum cover.
16)	The vacuum cover gasket doesn't adhere properly	⇒	Replace the vacuum cover gasket.

The vacuum motor doesn't work properly

- 1) The vacuum motor is switched off ⇒ *Switch on the vacuum motor.*
 - 2) The vacuum motor is not powered properly ⇒ *Check the power connections on the vacuum motor.*
 - 3) The vacuum motor switch doesn't work ⇒ *Replace the switch (see section [4.1.5](#) at page [17](#)).*
 - 4) The vacuum motor carbon brushes are worn out ⇒ *Replace the vacuum motor carbon brushes (see section [7.4.6](#) at page [47](#)).*
 - 5) The vacuum motor is supplied but it doesn't work ⇒ *Replace the vacuum motor.*
-

3.4 Frame and traction system: what to do if...

The machine doesn't move forward

- | | | |
|--|---|--|
| 1) The machine is switched off | ⇒ | <i>Switch on the machine.</i> |
| 2) The machine doesn't switch on | ⇒ | <i>Check the proper section (see section 3.1 at page 8).</i> |
| 3) The dead man lever is not pressed | ⇒ | <i>Push the dead man lever.</i> |
| 4) The dead man switch is not properly connected | ⇒ | <i>Restore the proper connection to the dead man switch.</i> |
| 5) The dead man switch doesn't work | ⇒ | <i>Replace the dead man switch (see section 4.1.8 at page 18).</i> |
-

The machine doesn't move straight

- | | | |
|--|---|---|
| 1) The brush is not properly engaged | ⇒ | <i>Release the brush and engage it properly.</i> |
| 2) The brush deck is not properly adjusted | ⇒ | <i>Adjust properly the brush deck (see section 6.3.1 at page 39).</i> |
-

3.5 Solution delivery system: what to do if...

The delivered solution is not correct or not enough

1)	The machine is switched off	⇒	<i>Switch on the machine.</i>
2)	The machine doesn't switch on	⇒	<i>Refer to the proper section (see section 3.1 at page 8).</i>
3)	The clean water compartment of the tank is empty	⇒	<i>Fill up the clean water compartment.</i>
4)	The water valve is adjusted at minimum	⇒	<i>Open the water valve to the desired position.</i>
5)	The solenoid valve doesn't work	⇒	<i>Check the solenoid valve connections and, if necessary, replace it (see section 4.5.5 at page 28).</i>
6)	The solution filter is stuck	⇒	<i>Clean the solution filter.</i>
7)	The detergent doesn't fit the type of dirt	⇒	<i>Replace the detergent with a proper one.</i>

Chapter 4

Disassembling Procedures

WARNING: BEFORE TO PERFORM ANY OPERATION DESCRIBED BELOW VERIFY THAT THE MACHINE TANK COMPARTMENTS ARE COMPLETELY EMPTY, THE MACHINE HAS TO BE TURNED OFF. DISCONNECT THE BATTERIES AND REMOVE THEM FROM THE MACHINE. AT LAST, VERIFY THAT THE PARKING BRAKE IS ENGAGED AND THE MACHINE IS IN A TOTALLY SAFE CONDITION.

4.1 Electrical Installation

4.1.1 Function Dashboard

- Put the machine in safe conditions.
- Lower the Squeegee to the floor.
- Remove the cable and the bushing from the squeegee lifting lever by loosening the screw (see fig. 4.1.1-1).
- Open the external dashboard by loosening the screws (see fig. 4.1.1-2).
- Loose the screws that block the Function Dashboard to the machine (see fig. 4.1.1-3).
- Remove the function Dashboard.
- Proceed at reverse to refit the part.

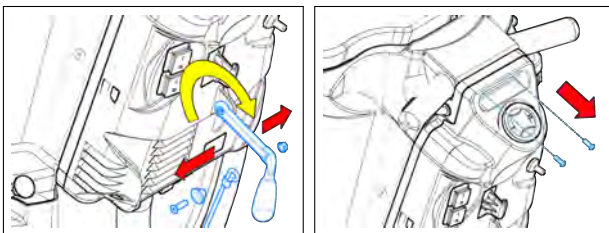

4.1.1-1

4.1.1-2

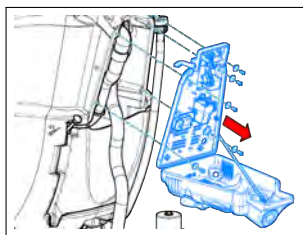

4.1.1-3

4.1.2 External dashboard retaining cable

- Put the machine in safe conditions.
- Open the external dashboard by loosening the screws (see fig. 4.1.1-2).

- After having provided a support for the dashboard, remove the screws that secure the ends of the retaining cable (see fig. 4.1.2-4) (see fig. 4.1.2-5).
- Proceed at reverse to refit the part.

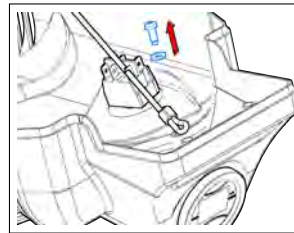

4.1.2-4

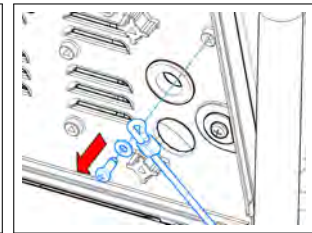

4.1.2-5

4.1.3 External Dashboard

- Put the machine in safe conditions.
- Low the Squeegee on the floor and remove the squeegee lifting lever (see section 4.3.11 at page 26).
- Open the external dashboard by loosening the screws (see fig. 4.1.3-6).
- Unplug all the wires and cables that connect the electrical devices on the external Dashboard.
- Loose the screws that block the retaining cable to the dashboard (see fig. 4.1.3-7).
- Loose the screws that block the external dashboard to the machine (see fig. 4.1.3-8).
- Remove the External Dashboard (see fig. 4.1.3-9).
- Proceed at reverse to refit the part.

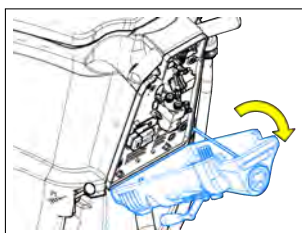

4.1.3-6

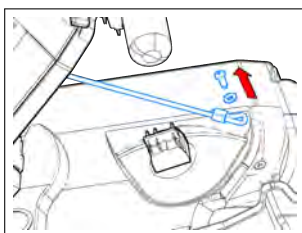

4.1.3-7

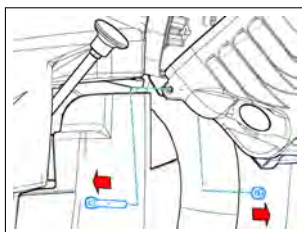

4.1.3-8

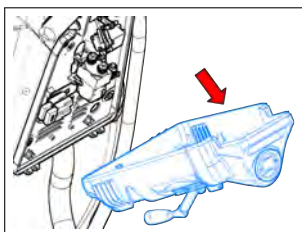

4.1.3-9

4.1.4 BDI (Battery Discharge Indicator)

- Put the machine in safe conditions.
- Open the external dashboard by loosening the screws.
- Unplug the multipolar connector from the BDI (Ref.2) (see section 5.3 at page 32).
- Loosen the knobs that block the BDI to its bracket.
- Remove the BDI from the Function Dashboard (see fig. 4.1.4-10).
- Proceed at reverse to refit the part.

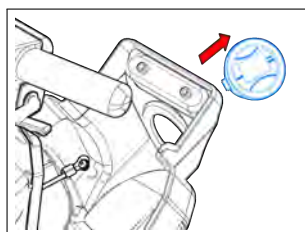

4.1.4-10

4.1.5 Function Switch

- Put the machine in safe conditions.
- Open the external dashboard by loosening the screws.
- Unplug all the wires and cables connected to the Function Switch (Ref.7;8) (see section 5.3 at page 32).
- Remove the Function Switch from the external dashboard (see fig. 4.1.6-11).
- Proceed at reverse to refit the part.

4.1.6 Brush Release Switch

- Put the machine in safe conditions.
- Open the external dashboard by loosening the screws.
- Unhook the levers tension spring.
- Loosen the Rubber Cap that protect the Brush Release Switch.
- Disconnect the cables connected to the switch (Ref.18) (see section 5.3 at page 32).
- Unscrew the ring nut and remove the Brush Release Switch (see fig. 4.1.6-12).
- Proceed at reverse to refit the part.

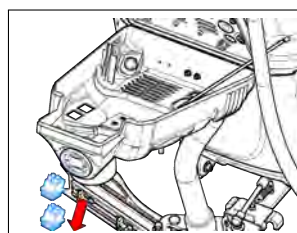

4.1.6-11

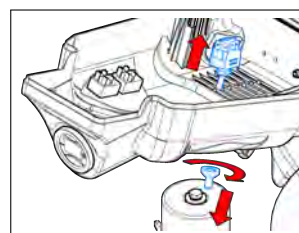

4.1.6-12

4.1.7 Operator control levers

- Put the machine in safe conditions.
- Open the external dashboard by loosening the screws.
- Remove the screws that secure the right and left control levers to the central cam and remove the levers (see fig. 4.1.7-13).
- Loosen the screw that holds the tension spring and remove it along with the cam (see fig. 4.1.7-14).
- Remove the screw, the dowel and the nuts from the cam (see fig. 4.1.7-15).
- Proceed at reverse to refit the part.

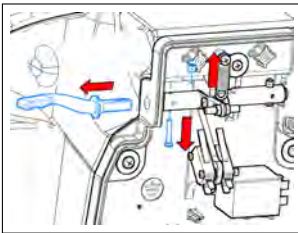

4.1.7-13

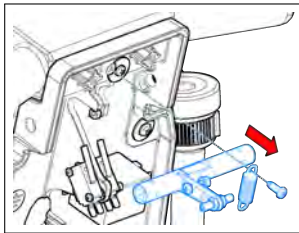

4.1.7-14

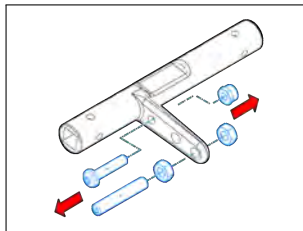

4.1.7-15

4.1.8 Microswitches

- Put the machine in safe conditions.
- Open the external dashboard by loosening the screws.
- Disconnect all the cables connected to the microswitch (Ref.3;4) (see section 5.3 at page 32).
- Loosen the screws that block the microswitch to the internal dashboard (see fig. 4.1.9-16).
- Remove the microswitch.
- Proceed at reverse to refit the part.

4.1.9 Vacuum Motor Contactor

- Put the machine in safe conditions.
- Open the external dashboard by loosening the screws.
- Unplug the wires connected to the Vacuum Motor Contactor (Ref.12) (see section 5.3 at page 32).
- Loosen the screws that block the Vacuum Motor Contactor to the internal dashboard (see fig. 4.1.9-17).
- Remove the Vacuum Motor Contactor.
- Proceed at reverse to refit the part.

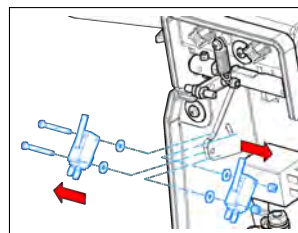

4.1.9-16

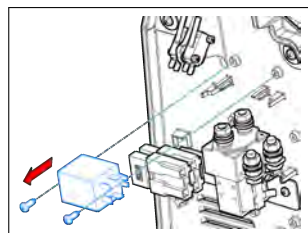

4.1.9-17

4.1.10 Brush Gearmotor Contactor

- Put the machine in safe conditions.
- Open the external dashboard by loosening the screws.
- Unplug the wires connected to the brush gearmotor contactor (Ref.11) (see section 5.3 at page 32).
- Loose the screws that block the support plate to the internal dashboard (see fig. 4.1.10-18).
- Loose the screws that block the brush gearmotor contactor to the support plate (see fig. 4.1.10-19).
- Remove the brush gearmotor contactor.
- Proceed at reverse to refit the part.

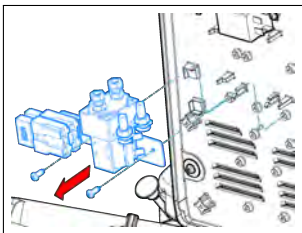

4.1.10-18

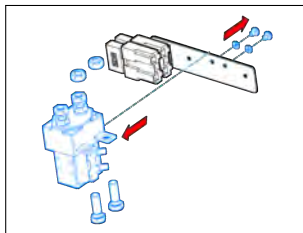

4.1.10-19

4.1.11 Battery Charger

- Put the machine in safe conditions.
- Open the external dashboard by loosening the screws.
- Disconnect the power cables of the charger from the electrical harness (Ref.20) (see section 5.3 at page 32).
- Disconnect the safety cables of the charger from the electrical harness.
- Loose the screws that block the Battery Charger to the internal Dashboard and remove it (see fig. 4.1.11-20).
- Proceed at reverse to refit the part.

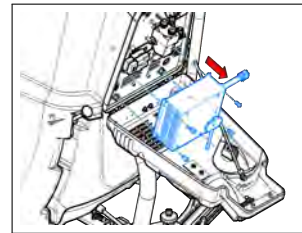

4.1.11-20

4.2 Mechanical Friction System

4.2.1 Brush Deck Assembly

- Release the brush from the Brush Deck (see fig. 4.2.1-21).
- Put the machine in safe conditions.
- Remove the front cover by unscrewing the fixing screws (see fig. 4.2.1-22).
- Disconnect the solution hose from the filter.
- Disconnect the electrical connector of the vacuum motor and the solenoid (see fig. 4.2.1-23).
- Remove the left screw securing the scrubbing base support to the frame (see fig. 4.2.1-24).
- Remove the right screws securing the scrubbing base support to the frame (see fig. 4.2.1-25).
- Tilt the machine till the parking position and remove the Complete Brush Deck with a rototranslatory movement (see fig. 4.2.1-26).
- Disconnect the intake manifold from the vacuum motor.
- Proceed at reverse to refit the part.

Note: If necessary, remove the electrical connections of the brush gearmotor.

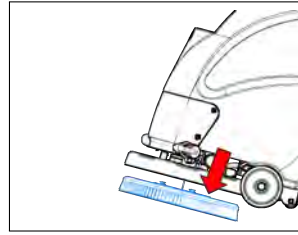

4.2.1-21

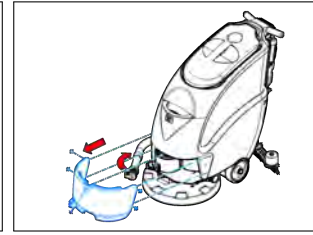

4.2.1-22

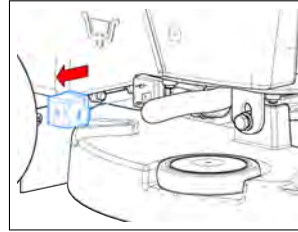

4.2.1-23

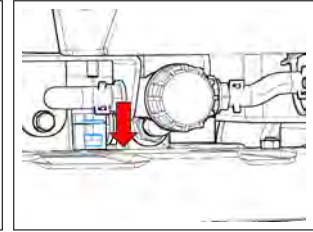

4.2.1-24

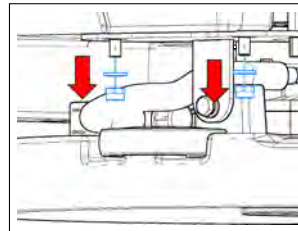

4.2.1-25

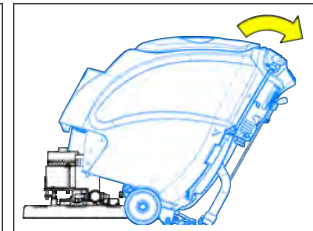

4.2.1-26

4.2.2 Brush Coupling Flange

- Put the machine in safe conditions.
- Disassemble the Brush Deck from the machine (see section 4.2.1 at page 20).
- Lay the Brush Deck inclined to let it be rest on the base and on the cover of brush gearmotor.
- Unscrew the Coupling Flange rotating it in the same direction as the brush in standard working conditions (see fig. 4.2.3-27).
- Remove the spacer.
- Proceed at reverse to refit the part.

Note: Before to refit the part lubricate the thread in order to prevent blockings because of dirt or oxide.

4.2.3 Brush Stopper Spring

- Put the machine in safe conditions.
- Disassemble the Brush Deck from the machine (see section 4.2.1 at page 20).
- Disassemble the Brush Coupling Flange (see section 4.2.2 at page 20).
- Loose the screw that block the Brush Stopper Spring.
- Remove the Brush Stopper Spring (see fig. 4.2.3-28).
- Proceed at reverse to refit the part.

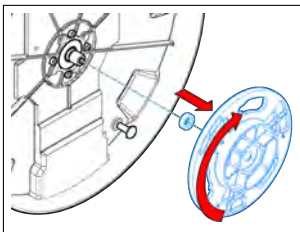

4.2.3-27

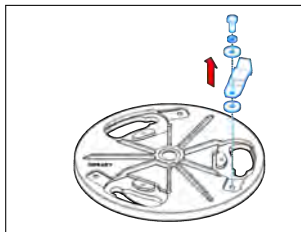

4.2.3-28

4.2.4 Brush Gearmotor

- Put the machine in safe conditions.
- Disassemble the Brush Deck from the machine (see section 4.2.1 at page 20).
- Disassemble the Brush Coupling Flange (see section 4.2.2 at page 20).
- Unplug the Hose that connects the Filter to the solenoid Valve (see fig. 4.2.4-29).
- Remove the vacuum motor support plate by loosening the screws (see fig. 4.2.4-30).
- Unplug the Hose that connects the Solenoid Valve to the Brush gearmotor (see fig. 4.2.4-31).
- Loose the 4 blocking screws and remove the Brush gearmotor (see fig. 4.2.4-32).
- Proceed at reverse to refit the part, taking care to use the non-countersunk holes.

Note: Use the thread lock liquid on the screws during the assembling.

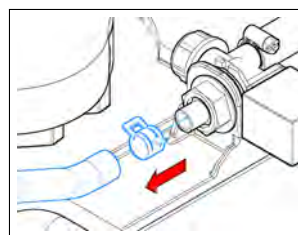

4.2.4-29

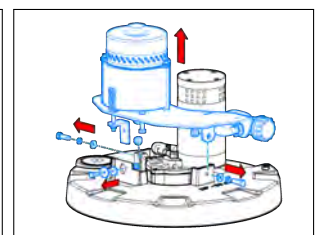

4.2.4-30

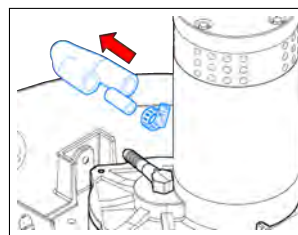

4.2.4-31

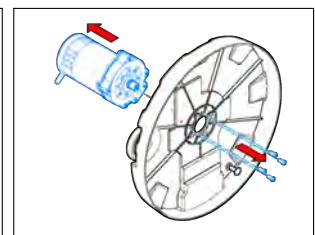

4.2.4-32

4.2.5 Bumper Wheel

- Release the Brush from the Brush deck (see fig. 4.2.5-33).
- Put the machine in safe conditions.
- Tilt the machine in the parking conditions.
- Loose the upper bushing of the Bumper Wheel (see fig. 4.2.5-34).
- Remove the Bumper Wheel paying attention to the spacer.
- Proceed at reverse to refit the part.

Note: Use the thread lock liquid on the screw during the assembling.

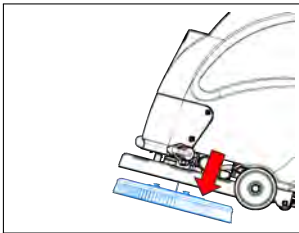

4.2.5-33

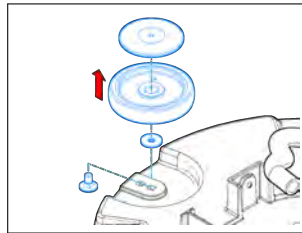

4.2.5-34

4.3 Drying System

4.3.1 Squeegee

- Put the machine in safe conditions.
- Lower the Squeegee to the floor.
- Unplug the Vacuum Hose from the squeegee.
- Loose the knob that blocks the Squeegee to the Squeegee Support (see fig. 4.3.1-35).
- Remove the Squeegee from the Squeegee Support (see fig. 4.3.1-36).
- Proceed at reverse to refit the squeegee.
- Perform the adjustment procedure for the Squeegee (see section 7.3.1 at page 44).

Note: The Squeegee has to be refit on the machine with the washer on the upper part of the Squeegee Support (see fig. 4.3.1-37).

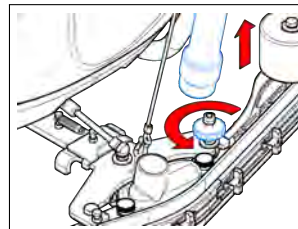

4.3.1-35

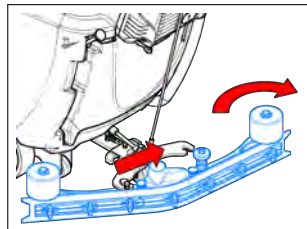

4.3.1-36

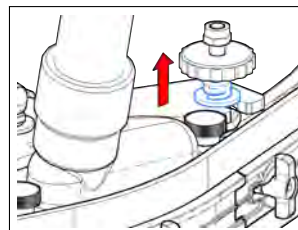

4.3.1-37

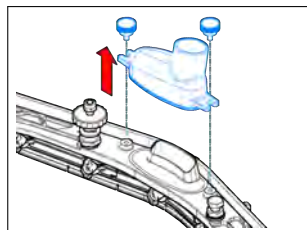

4.3.1-38

4.3.2 Squeegee Adapter

- Put the machine in safe conditions.
- Disassemble the Squeegee from the Machine (see section 4.3.1 at page 22).
- Loose the knobs that block the Squeegee Adapter to the Squeegee (see fig. 4.3.1-38).
- Remove the Squeegee Adapter.
- Proceed at reverse to refit the part.

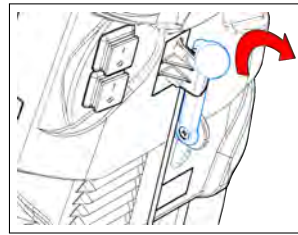

4.3.3-39

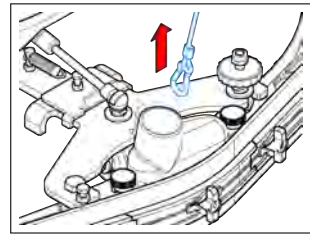

4.3.3-40

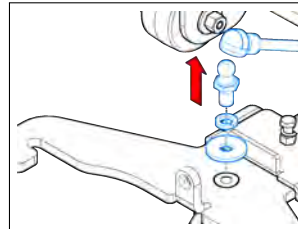

4.3.3-41

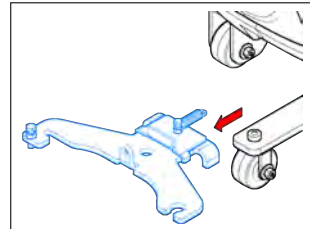

4.3.3-42

4.3.3 Squeegee Support

- Put the machine in safe conditions.
- Disassemble the Squeegee from the Machine (see section 4.3.1 at page 22).
- Remove the lifting cable from the support by releasing the hook (see fig. 4.3.3-40).
- Remove the gas spring from the hub by lifting it carefully (see fig. 4.3.3-41).
- Unscrew and remove the hub of the gas spring (see fig. 4.3.3-41).
- Release the traction spring and remove the squeegee support (see fig. 4.3.3-42).
- Proceed at reverse to refit the part.

4.3.4 Front arm and squeegee wheel

- Put the machine in safe conditions.
- Remove the squeegee support (see section 4.3.3 at page 23).
- Remove the circlips that hold the arm pivot and remove it (see fig. 4.3.4-43).
- Loosen the screw securing the wheel to the support and remove it together with the bushing (see fig. 4.3.4-44).
- Proceed at reverse to refit the part taking care about the bushing positioning.

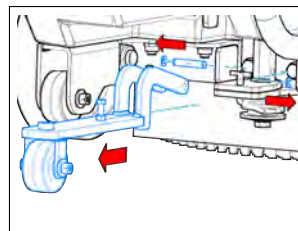

4.3.4-43

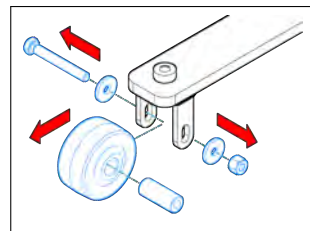

4.3.4-44

4.3.5 Vacuum Hose

- Put the machine in safe conditions.
- Remove the function dashboard (see section 4.1.1 at page 16).
- Unplug the Vacuum Hose from the Squeegee (see fig. 4.3.5-45).
- Unplug the Vacuum Hose from the recovery compartment upper Inlet (see fig. 4.3.5-46).
- Proceed at reverse to refit the part.

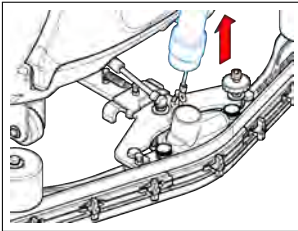

4.3.5-45

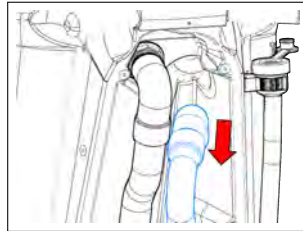

4.3.5-46

4.3.6 Tank

- Put the machine in safe conditions.
- Remove the function dashboard (see section 4.1.1 at page 16).
- Uncouple the Vacuum Hose and the Intake Manifold from the Recovery compartment Inlet.
- Disassemble the Brush Deck from the machine (see section 4.2.1 at page 20).
- Remove the electrical connections of the brush gearmotor.
- Disconnect the hose clamp that secures the intake manifold to the vacuum motor inlet (see fig. 4.3.6-47).
- Remove the vacuum motor cap (see fig. 4.3.6-48).
- Remove the nuts securing the tank to the frame (see fig. 4.3.6-49).
- Remove the tank from the machine frame (see fig. 4.3.6-50).
- Proceed at reverse to refit the part.

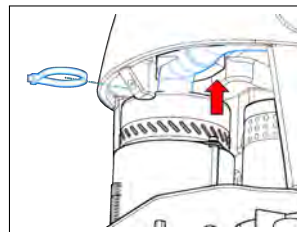

4.3.6-47

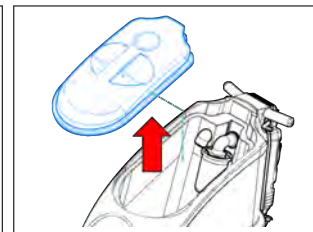

4.3.6-48

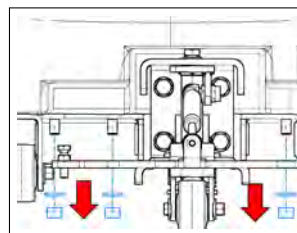

4.3.6-49

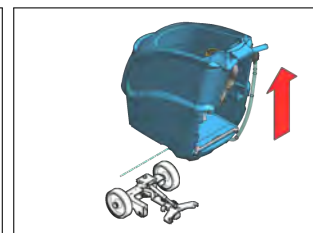

4.3.6-50

4.3.7 Drain Hose

- Put the machine in safe conditions.
- Disassemble the Brush Deck from the machine (see section 4.2.1 at page 20).
- Rest the front part of the tank to a support.
- Loosen the clamp that blocks the Drain Hose to the Tank (see fig. 4.3.7-51).
- Unplug the Drain Hose from the Tank.
- Proceed at reverse to refit the part.

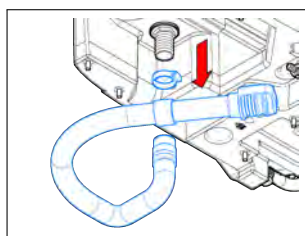

4.3.7-51

4.3.8 Vacuum Filter

- Put the machine in safe conditions.
- Remove the Lid of the recovery compartment (see fig. 4.3.8-52).
- Uncouple the Filter Cover and remove the Vacuum Filter pulling it down (see fig. 4.3.8-53).
- Proceed at reverse to refit the part.



4.3.8-52

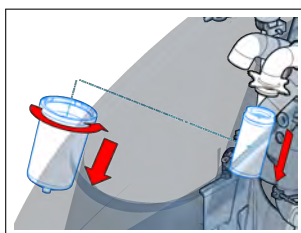

4.3.8-53

4.3.9 Vacuum Motor

- Put the machine in safe conditions.
- Disassemble the Brush Deck from the machine (see section 4.2.1 at page 20).
- Remove the vacuum motor from the bracket by unscrewing the screws on the mounting studs (see fig. 4.3.9-54).
- Remove the sound-absorbing Sponge.
- Loosen the screws to remove the Vacuum Motor Bracket (see fig. 4.3.9-55).
- Proceed at reverse to refit the part.

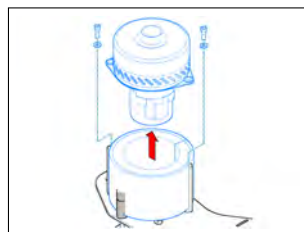

4.3.9-54

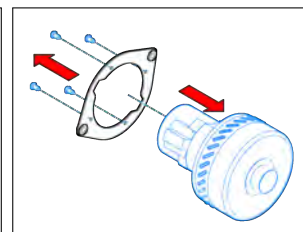

4.3.9-55

4.3.10 Squeegee Lifting cable

- Put the machine in safe conditions.
- Lower the Squeegee to the floor.
- Disconnect the lifting cable from the lever by removing the screw (see fig. 4.3.10-56).
- Disconnect the lifting cable from the squeegee support by removing the hook (see fig. 4.3.10-57).
- Remove the squeegee lifting cable.
- Proceed at reverse to refit the part.

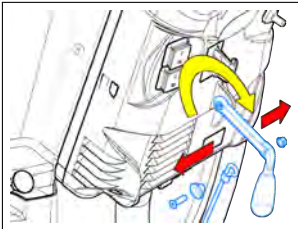

4.3.10-56

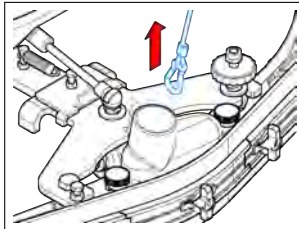

4.3.10-57

4.3.11 Squeegee Lifting Lever

- Put the machine in safe conditions.
- Lower the Squeegee to the floor.
- Remove the Squeegee Lifting Lever from the external dashboard by removing the screw (see fig. 4.3.11-58).
- Remove the lifting cable and the bushing from the lever by removing the screw (see fig. 4.3.11-59).
- Proceed at reverse to refit the part.

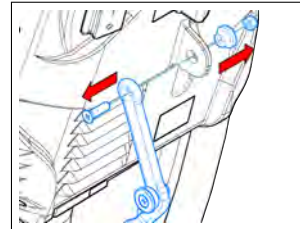

4.3.11-58

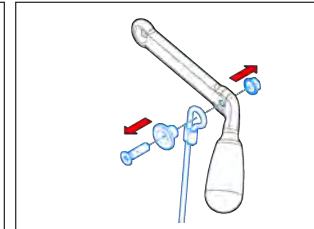

4.3.11-59

4.4 Frame and Traction System

4.4.1 Wheels

- Put the machine in safe conditions.
- Lift up the wheel from the ground.
- Unscrew the screw pin of the wheel (see fig. 4.4.1-60).
- Remove the wheel.
- Proceed at reverse to refit the part (Lubricate the screw pin during assembly).

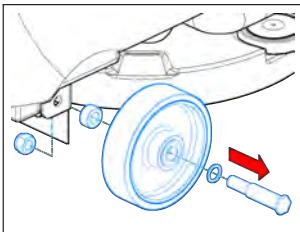

4.4.1-60

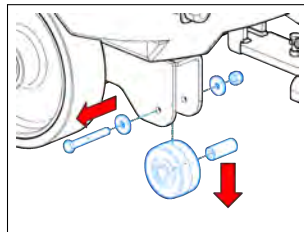

4.4.1-61

4.4.2 Parking Wheel

- Put the machine in safe conditions.
- Tilt the machine to lower the brush deck on the floor.
- Loose the screw and the nut that blocks the wheel to the Machine Frame (see fig. 4.4.1-61).
- Remove the Parking Wheel.
- Remove the bushing from the wheel.
- Proceed at reverse to refit the part.

Note: Lubricate the bushing during assembly.

4.5 Solution Delivery System

4.5.1 Tank

- Remove the tank (see section 4.3.6 at page 24).

4.5.2 Hoses

- Put the machine in safe conditions.
- Loose the clamps that block the hose to the fitting.
- Slip off the hose from the fitting.
- Proceed at reverse to refit the part.

4.5.3 Solution Filter

- Put the machine in safe conditions.
- Disconnect the hoses from the fittings connected to the filter.
- Unscrew the fitting and the filter and remove it from its housing (see fig. 4.5.3-62).
- Proceed at reverse to refit the part.

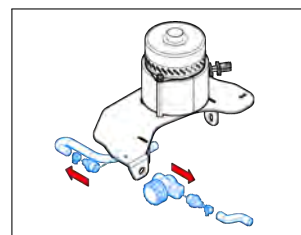

4.5.3-62

4.5.4 Water Valve

- Put the machine in safe conditions.
- Unplug the rubber hose from the Water Valve loosening the hose clamps (see fig. 4.5.4-63).
- Remove the the circlips that secures the adjustment rod tap (see fig. 4.5.4-64).
- Remove the Water valve and the fitting by unscrewing them from the tank (see fig. 4.5.4-65).
- Proceed at reverse to refit the part (Use sealing liquid on the fitting to refit the part).

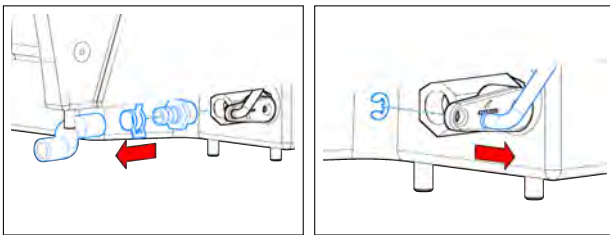

4.5.4-63

4.5.4-64

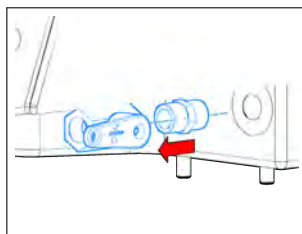

4.5.4-65

4.5.5 Solenoid Valve

- Put the machine in safe conditions.
- Disassemble the Brush Deck from the machine (see section 4.2.1 at page 20).
- Unplug the hoses connected to the Solenoid Valve (see fig. 4.5.5-66).
- Loose the ring nut that block the Solenoid Valve to its support (see fig. 4.5.5-67).
- Loose the solenoid Valve cap and remove the OR gasket (see fig. 4.5.5-68).
- Proceed at reverse to refit the part (Position the spacer washer properly to refit the valve on the brush deck).

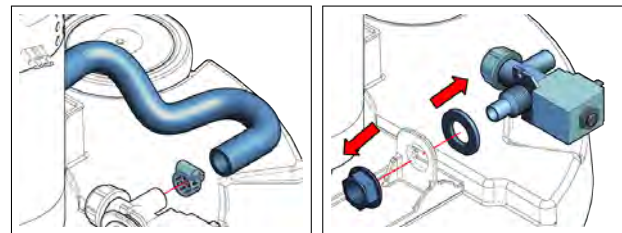

4.5.5-66

4.5.5-67



4.5.5-68

Part III

Machine Description

Chapter 5

Electrical System

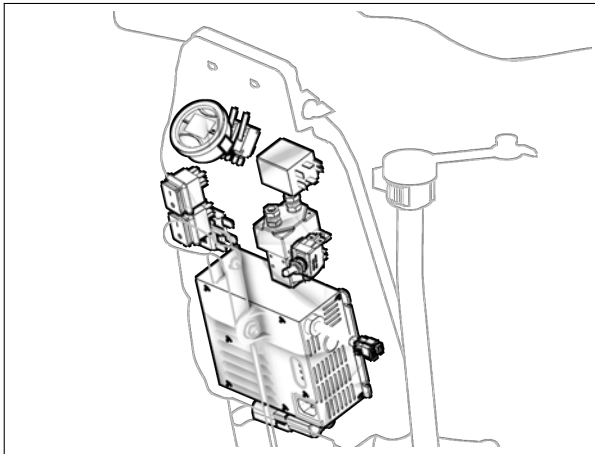

5.1 Structure

- Vacuum Relay
- Brush remote control switch
- Fuses
- Brush release switch
- Control switches
- Hourmeter/Battery control card
- Charger
- Operator lever microswitch
- Batteries

5.2 Description

To wash and dry the floor you have to press the buttons present on the dash board of the machine.

With the buttons you can switch ON or OFF the brush base, the solenoid valve and the vacuum motor.

These signal are combined by electromechanical logic together with the operator lever microswitch; they act in order to operate in the best way and in absolute safety for the operator.

On the dash board there is a switch to release the brush.

5.3 Location of Electrical components

5-32

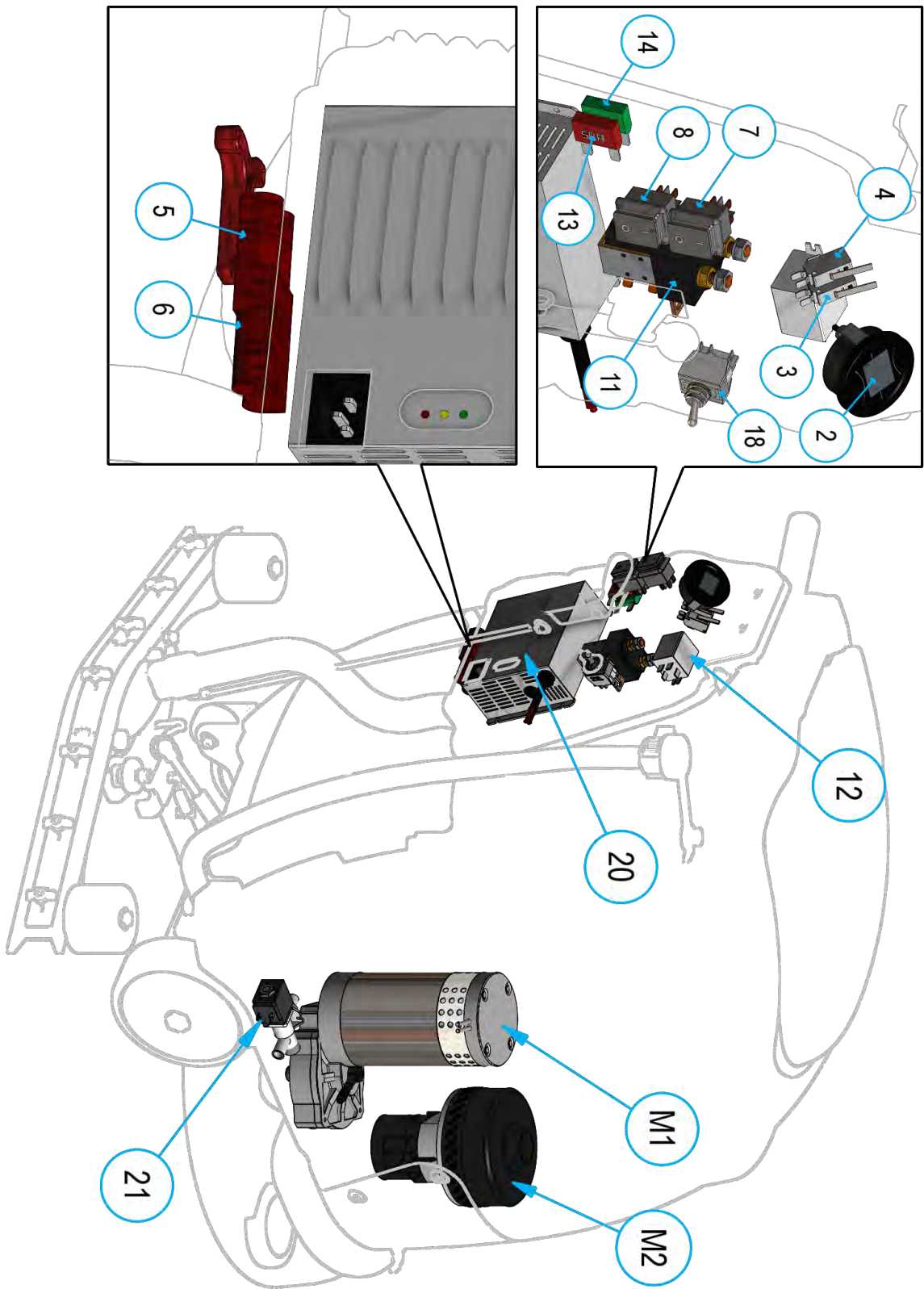

List of Components

- 2 Hourmeter and Battery control card
- 3 Hourmeter activation Microswitch
- 4 Brush gearmotor and solenoid activation Microswitch
- 5 50A Female Connector
- 6 50A Male Connector
- 7 Vacuum Motor Switch
- 8 Main switch
- 11 Brush gearmotor Remote control switch
- 12 Vacuum Motor Relay
- 13 Brush gearmotor Fuse
- 14 Vacuum Motor Fuse
- 18 Brush Release Switch
- 20 Charger¹
- 21 Solenoid Valve
- M1 Brush Gearmotor
- M2 Vacuum Motor

¹Optional

5.4 Operator Lever Microswitches

My50 is equipped with Safety microswitches, located on the handle of the machine and operated by the levers. **These microswitches** allow to activate the hourmeter and the mechanical rubbing system together with the solenoid valve.

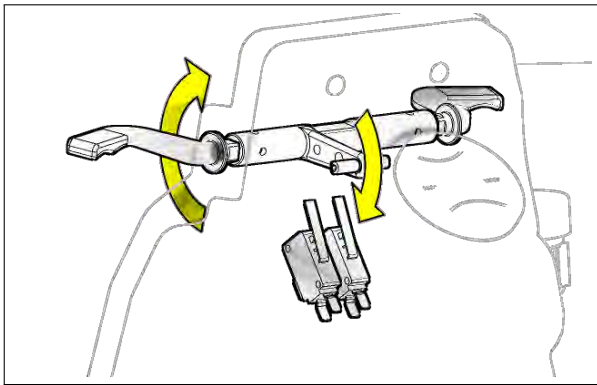

5.5 Hourmeter

The machine is equipped with an **electronic hourmeter** installed on the dashboard. The hourmeter shows the **total worked hours** of the machine and the **battery charge level** on the display. The hourmeter can stop the machine if the residual charge of the batteries is under a minimum threshold which could compromise its life cycle. **The hourmeter** can be set up according to the battery type fitted on the machine.

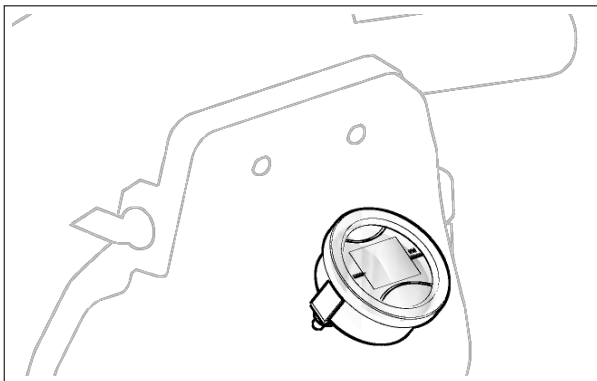

5.6 Charger

The charger is available as optional. The charger is located inside the housing of the machine's electrical system, with free access to connect the charger to the power supply.

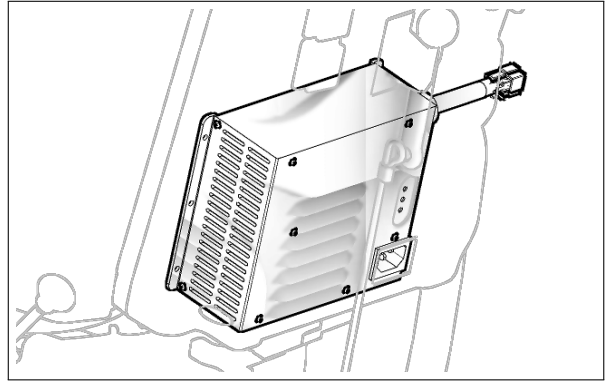

5.7 Batteries

On the machine is possible to install different type of batteries. The battery compartment is suitably equipped with a containment strap and a metal bracket.

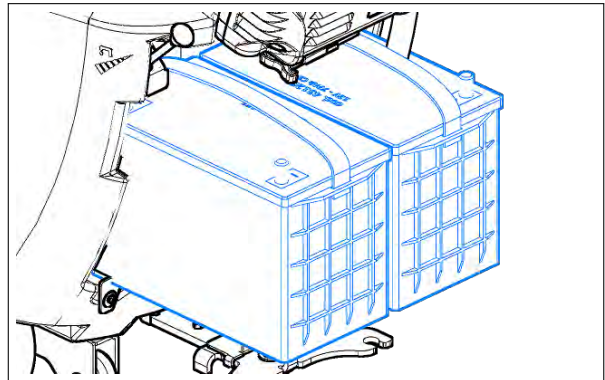

5.8 Adjustments

5.8.1 Operator Lever microswitches

Check the functionality and the status of the safety microswitches. When the microswitch is pressed, it have to remain **0,5 mm** of free space, between the lever and the microswitch. Check the functionality of the lever. If not working properly, replace the microswitch.

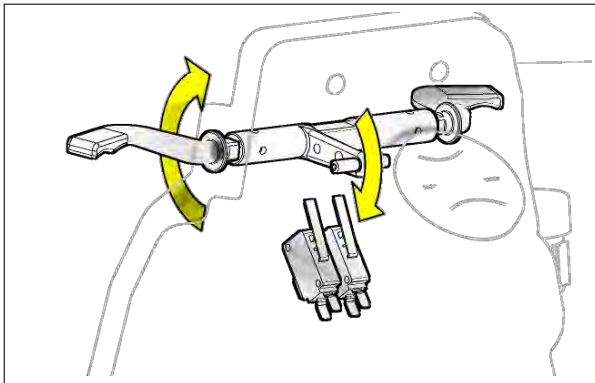

5.8.2 Battery Control Card

Check that, when switching on the machine, the battery control card (included in the hourmeter) has the following starting sequence:

- For the first 2 seconds, display the setting of the dip switches
- Then display the total worked hours and level of residual charge of the battery

It is possible to check the settings of the battery control card, simply turning the machine on and check for the first 2 seconds the reading on the display. The value on the left indicates the rated voltage set for the battery (eg. 24V). The value on the right indicates the maximum threshold of discharge (eg. 20.2V).

For **Wet Cell** batteries the value of the right must be equal to **20.2V**, For **GEL/AGM** batteries instead, the value of the right must be equal to **21.8V**. To adjust the battery control card depending on the batteries installed, set the microswitch located behind the hourmeter, (Picture) as shown in the table.



Hourmeter Dip switch Setting						
1	2	3	4	5	6	Setup
OFF	ON	OFF	OFF	OFF	OFF	Wet Cell
OFF	ON	ON	OFF	OFF	OFF	GEL / AGM

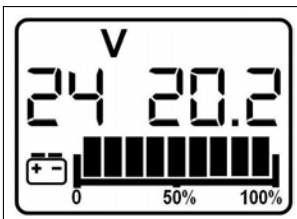

5.8.2-69 Switch On

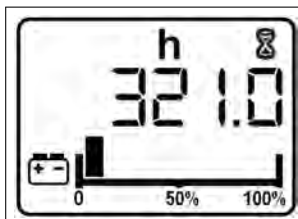

5.8.2-70 After 2 seconds

5.8.3 Charger (CB)

The charger is located in the control dashboard of the machine and easy to access for the operator. When connected to the power supply, a red led will blink once, the yellow led blink once and the green led blink depending of the type of battery for which the charger is set.

- Set-up the internal dip switches according to the following table.

The dip switches are divided in two couples. The higher couple are the dip switches 1 and 2, the couple down are the dip switches 3 and 4. The following table shows how to setup the dip switches 1 and 2.



Set-up of Charging Curve			
DP1	DP2	Set-up	Flash
OFF	OFF	Wet cell batteries	1
ON	ON	Gel TROJAN	2
OFF	ON	Generic GEL or AGM batteries	3
ON	OFF	Gel EXIDE SON-NENSCHHEIN	4

DP3: OFF (not used)

DP4: OFF (not used)

Restore the the small black plastic cup.

A Proper Charging cycle follows the below phases order.

Phase	LED	Description
A	Red	Blinking, check of battery status
B	Red	First charging phase
C	Yellow	Second charging phase
D	Green	Charged battery

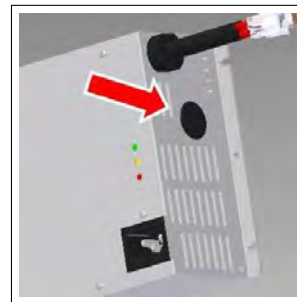

5.8.3-71 Cap

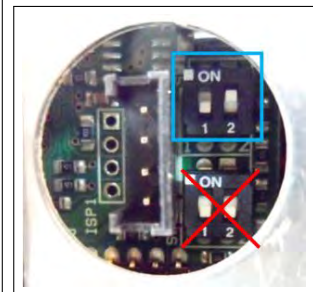

5.8.3-72 Dip switch

Check if the charger is properly set according to the installed batteries, by following the setting instructions.

Charging curve SetUp

To set up the charger, follow the instructions:

- Open the external dashboard by loosening the screws.
- Use a screwdriver to remove the small black plastic cap.

Error Codes of Charger

The charger have an alarm system. The alarm code is shown by blinks of the yellow led.

Error code	
Flash	Description
1	Wrong battery, Inverted polarity, short circuit to the exit
2	Timeout alarm, Defect of the battery
3	Defect of the Charger
4	Overtemperature alarm

5.9 Maintenance and Checks

5.9.1 Electrical System

Check (to perform every **150h**)

Check the functions and the proper connections of the switches, microswitches, motors, solenoid valve, contactor, relay, fuses, thermal fuses and cables. Check periodically, the wiring connections. To check the wiring, unscrew the screws that secure the rear panel.

5.9.2 Batteries

Check (to perform every **150h**)

Check the proper connection of the plug cable, the contacts of the batteries connecting cables not to result oxidized.

5.10 Technical Features

TECHNICAL DESCRIPTION	U/M	My50 B
Dimension of Battery compartment (l x L x h)	mm	330x345x270
Batteries Rated Voltage	V	24
Maximum batteries weight	kg	54

5-38

5.11 Recommended Spare Parts

PN	Description
407578	DOUBLE REMOTE CONTR SW. 24V 100A SW84-P
407580	RELAY FINDER 65.31 30 A, 24 V SUCT. MOT.
409607	FUSE 30A
409612	FUSE 50A
440063	ELECTRONIC HOURMETER D=51,5 L=25
417622	SWITCH BLACK
409499	MICROSWITH 16A 3x22
434431	SWITCH ON-MOM 645H/2 10A 250V
437657	CHARGER NE286 24V 11A

Chapter 6

Mechanical Rubbing System

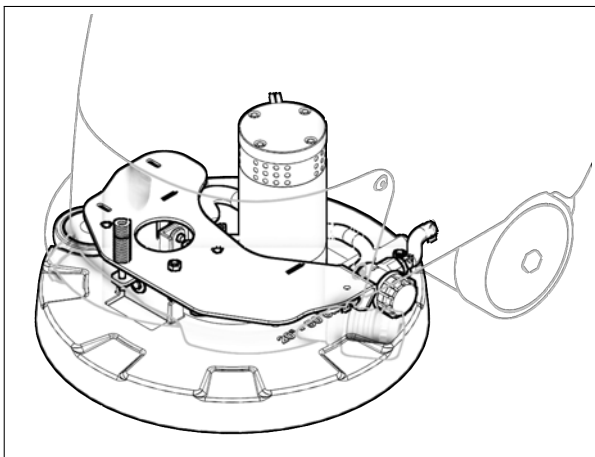

6.1 Structure

- Gearmotor
- Brass bushings
- Bumping Wheel
- Brush Base
- Brush coupling Flange
- Adjustment system

6.2 Description

The washing function of the machine is obtained by the interaction of the cleaning solution with the dirt present on the floor.

To facilitate and enhance this interaction, is used a system of mechanical rubbing which consists in a device which rubs on the floor.

This device can be of various nature (pad or brush), in each case, its function is to mechanically remove the dirt from the ground and facilitate the reaction between the dirt and cleaning solution.

A direct current electric motor connected to a case of gear reduction provides the rotational movement of the brush coupling flange.

To the flange is coupled the brush (or the pad holder provided with pad) that rotates together with the flange. After lowering the base to the ground, the brush touches and rubs on the floor providing the desired mechanical rubbing.

6.3 Adjustments

6.3.1 Brush Deck

The brush deck must be free to move pivoted to its support so that the brush acts parallel to the floor.

This allows the brush to evenly lean to the ground and perform its function properly.

Requirements: Mounted brush, Switched off machine.

Procedure:

- Hook the brush to the base.
- Adjust the direction adjusting screw (see fig. 6.3.1-73) so that it comes out **4 mm** from the nut below.
- Adjust the tilt adjusting screw (see fig. 6.3.1-74) in order to have **5 mm** clearance between the screw head and the scrubdeck.
- Switch on the machine, advance slowly in working condition and act on the screws so that the brush lies uniformly and parallel to the floor.

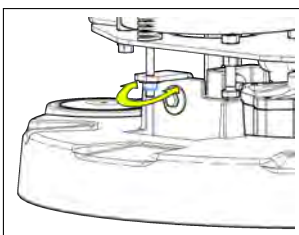

6.3.1-73 Direction

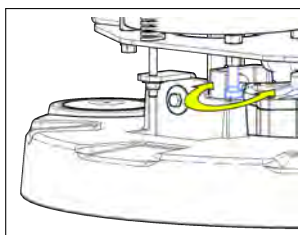

6.3.1-74 Tilting

6.4 Maintenance and checks

6.4.1 Gearmotor

Check (to perform every **150h**)
Remove the brush/es.

Tilt the machine in resting conditions and turn on the motor; the **current absorption** measured on the single motor must be less than **3,2 Amps**.

The motor should rotate evenly and smoothly and doesn't have to produce unusual noises. The motor contacts have to be clean, they have not to show signs of wear or heating in general.

The motor wires insulation has to be intact in all its parts and does not show signs of cracks. The single cable have to be flexible.

The carbon brushes must be 4-6 mm long and they have not to be abnormally worn out.

Maintenance (to perform every **600h**)

Motor carbon brushes replacement:

Procedure:

- Secure the machine.
- Remove the base from the machine.



- Loosen the screws that secure the collar brush guard.

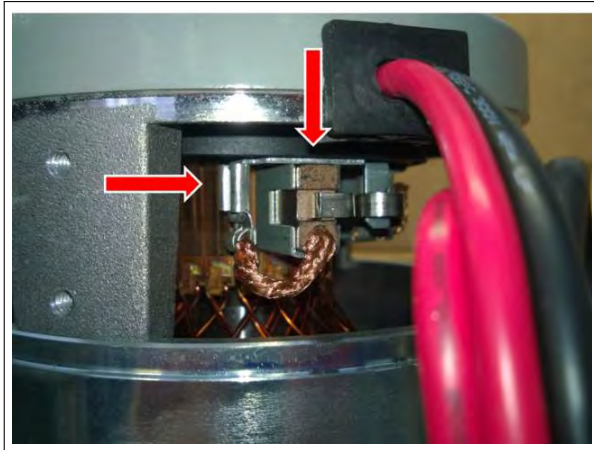

- Unscrew the Carbon brushes connector from the input power line to the motor.

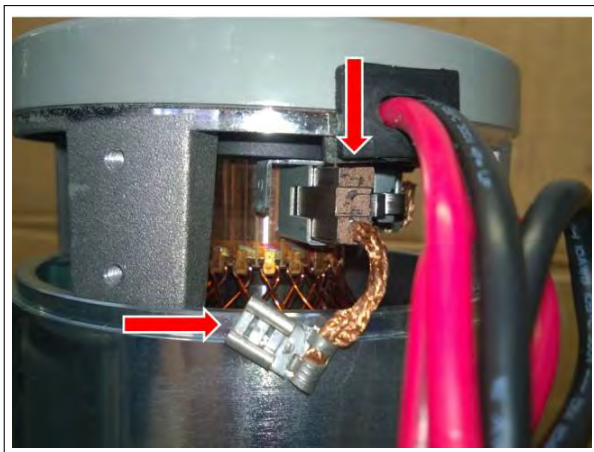

- Replace the carbon brushes being careful not to ruin them during assembly.
- Proceed to the reverse operations to reassemble it all.

6.4.2 Brass bushings

Check (to perform every 150h)

The brass bushings allow a fluid and little tiring rotational movement of the base. To prevent the base is locked in a position without the possibility of movement, is important that the brass bushings are in good condition and clean. In case of excessive wear it is necessary to proceed with the replacement.

Maintenance (to perform every 900h)

Brass bushings replacement:

Procedure:

- Secure the machine.
- Remove the screws that secure the Brush Deck to the Brush Deck support and tilt the machine till the parking position.
- Remove the bushings and replace them with new bushings.
- Proceed to the reverse operations to reassemble it all, sprinkle the new bushings with lubricating grease before mounting.

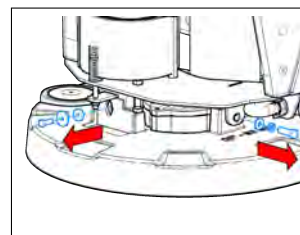

6.4.2-75 Vacuum motor support

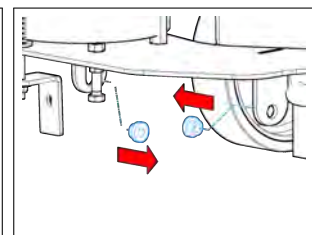

6.4.2-76 Bushings

6.4.3 Bumping Wheel

Check (to perform every 150h)

The bumping wheel must be free to rotate and its diameter must not be too small due to wear. A bumping wheel in poor condition can lead to cracking of the brush deck when working skimming some obstacles (walls, shelving, etc).

If necessary, replace it (see section 4.2.5 at page 22).

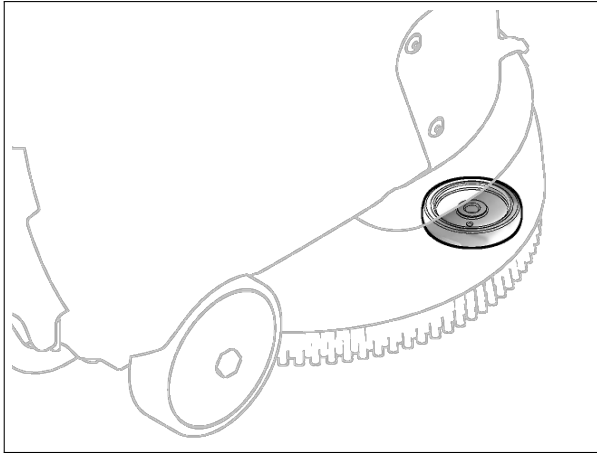

6.4.4 Brush Base

Check (to perform every 150h)

The basement must be kept clean and intact. A ruined basement may be dangerous to the machine and the operator that uses it.

If necessary, replace it (see section 4.2.4 at page 21).

6.4.5 Brush coupling flange

Check (to perform every 150h)

Like the other components the cleanliness of the brush coupling flange is essential to allow the brush to engage and disengage smoothly. It is also essential that the brush locking spring has full functionality in order to keep the brush in the correct position. If necessary, replace it (see section 4.2.2 at page 20).

6.4.6 Fixing and adjustment plate

Check (to perform every 150h)

The fixing plate must be in good condition, must not show signs of corrosion or deformation. An incorrect fixing and adjustment plate does not allow the entire Mechanical Rubbing group to work properly.

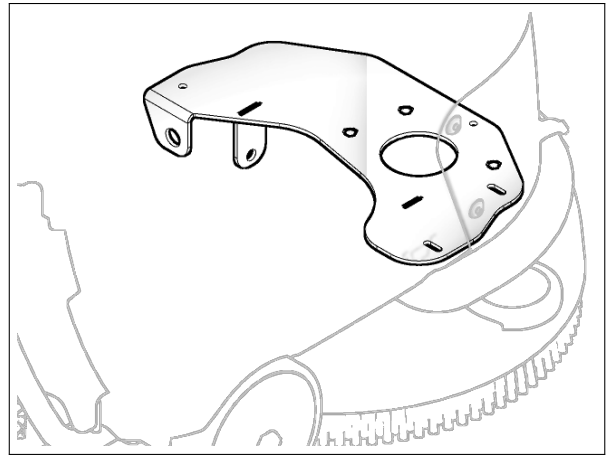

6.5 Technical Features

TECHNICAL DESCRIPTION	U/M	My50 B
Maximum diameter of the active part of the brush	ϕ mm	508
Brush turns	rpm	166
Brush motor voltage	V	24
Brush motor power	W	500
Max weight on brush in working condition	kg	32

6.6 Consumable Spare Parts

PN	Description	ϕ (mm)	Bristle	ϕ Bristle (mm)	Colour
404654	BRUSH PPL 0,3	508	PPL	0,3	Blue
405631	BRUSH PPL 0,6	508	PPL	0,6	White
404653	BRUSH PPL 0,9	508	PPL	0,9	Black
405632	BRUSH TYNEX	508	ABRASIVE	0,9	Gray
405527	PAD HOLDER	500	-	-	-
Carbon Brushes					
422462	BR.MOT.CARBON BR.	-	-	-	-

6.7 Recommended Spare parts

PN	Description
436120	BASE BUMPER WHEEL D=100 H=20
437859	BRUSH FLANGE
438300	GEAR MOTOR 24V 500W 140RPM THREADED SHAFT.

Chapter 7

Drying System

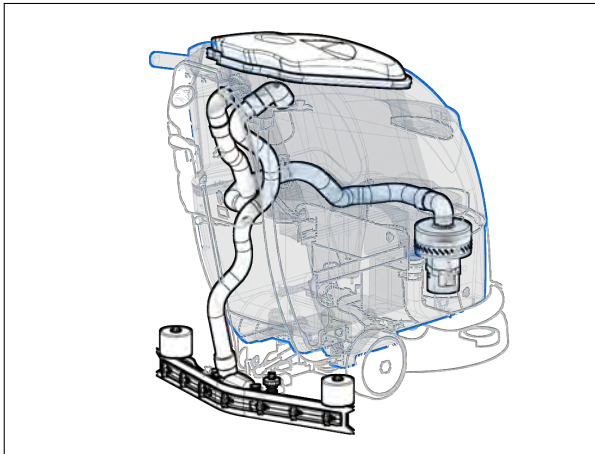

7-44

7.1 Structure

- Squeegee
- Squeegee support
- Vacuum Hose
- Tank Recovery Compartment
- Filter and Floating
- Intake Manifold
- Vacuum Motor

7.2 Description

The machine dries the floor using an integrated Drying System.

After the washing, the solution used with the mechanical action of the brush to remove the dirt, is collected by a system which vacuum it out from the floor.

The system is basically made by a vacuum motor which produces an underpressure in the system. This underpressure causes an air flow which flows in the whole vacuum circuit.

The air that flows in the squeegee (when it is lowered on the floor) allows it to collect the water on the floor mixing it with the water and, via the vacuum system, is brought to the recovery compartment.

In the recovery compartment the water mixed with the dirt stops and the air keep flowing throughout the circuit reaching the vacuum motor and being **discharged** in the environment.

7.3 Adjustments

7.3.1 Squeegee Support

The Squeegee Support has to be adjusted with the Squeegee fitted on and lowered on the floor. The goal of the adjustment is to let the squeegee blade be angled 45 degrees to the floor for its whole length.

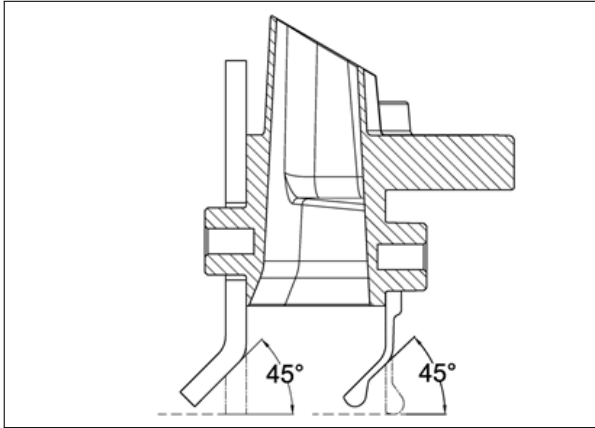

To obtain the proper squeegee adjustment act of the adjusting slot of the squeegee support wheel (see fig. 7.3.1-77) and the support screw (see fig. 7.3.1-78) to let the blade be bended equally for its whole length.

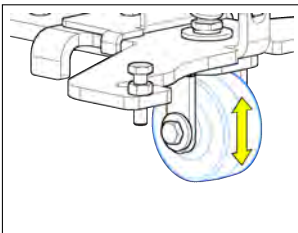

7.3.1-77 Height/Pressure

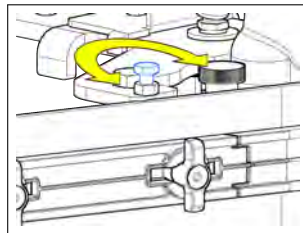

7.3.1-78 Inclination

Procedure

- Lower the squeegee on the floor with the rubber blades in vertical positions.
- Adjust the wheel of the squeegee support through the fixing screw (see fig. 7.3.1-77) until the wheels are lifted 2 mm from the floor ($\pm 0,1$ mm eventually help the adjustment with a spacer of that thickness).
- After having fixed the wheel, switch on the machine, advance slowly in working condition and act on the inclination screw (see fig. 7.3.1-78) in order to let the blade be equally angled for its whole length.
- Check the obtained adjustment with a functional test.

7.4 Maintenance and Checks

7.4.1 Squeegee

Check (to perform every 4h)

To have a good performance of the squeegee the blades have to be in a good conditions. The squeegee chamber and the squeegee adapter have to be clean and completely free from debris. Blades have to adhere perfectly to the squeegee body and have to be kept in that position by the plastic blade holder which are kept by the plastic wing nuts.

Maintenance (to perform every 45h)

- Put the machine in safe conditions.
- Remove the squeegee from the machine.
- Rotate the wing nut that block the blade holders.

- Remove the blade holders (see fig. 7.4.1-81).
- Remove the front blade and replace it with a new one (see fig. 7.4.1-83).
- Repeat the same operations for the rear blade. The rear blade can be used 4 times (one for each edge) before being replaced.
- Proceed at reverse to reinstall properly the blade holders.

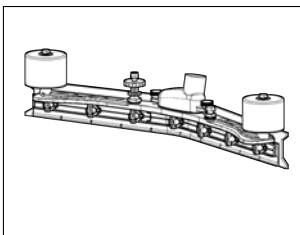

7.4.1-79 Front Rubber

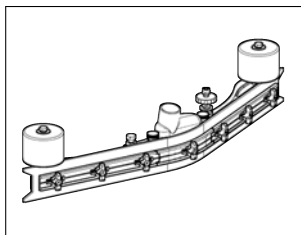

7.4.1-80 Rear Rubber

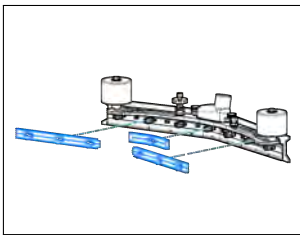

7.4.1-81 Front Rubber

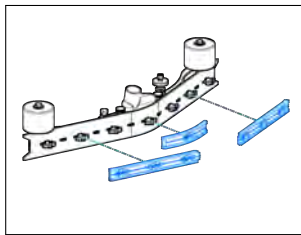

7.4.1-82 Rear Rubber

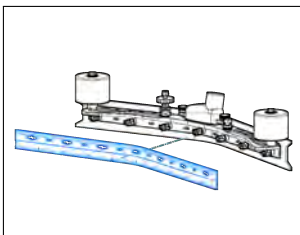

7.4.1-83 Front Rubber

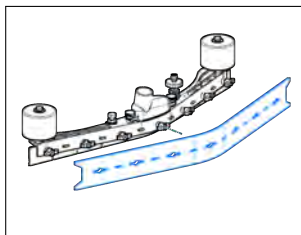

7.4.1-84 Rear Rubber

7.4.2 Squeegee Support

Check (to perform every 150h)

The squeegee support has to be completely free to move to lie perfectly on the floor. It is important that it can rotate freely and it is properly pressed on the floor by the gas spring.

Maintenance (to perform every 600h)

- Put the machine in safe conditions.
- Remove the squeegee from the squeegee support (see fig. 7.4.2-85), (see section 4.3.1 at page 22).
- Remove and replace the squeegee support wheel by loosening the wheel adjustment screw (see fig. 7.4.2-86), (see section 4.3.4 at page 23).

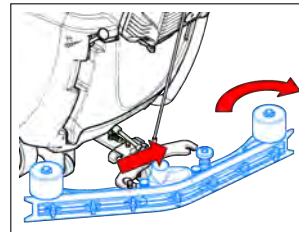

7.4.2-85

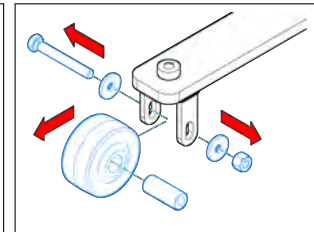

7.4.2-86

- Proceed at reverse to reinstall the parts.
- During the assembling lubricate the squeegee support eyelet.
- At the end of the assembling perform the proper squeegee adjustment (see section 7.3.1 at page 44).

7.4.3 Vacuum Hose

Check (to perform every 4h)

The vacuum hose has to be clean and intact. It is mandatory that the hose has no crack to not decrease the underpressure. To verify the vacuum hose goodness turn on the vacuum motor and block the lower part of the hose with the hand, in this way there must be no air passage.

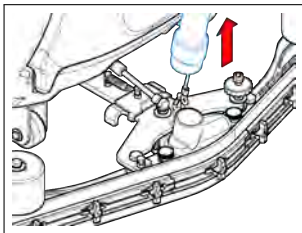

7.4.3-87

7.4.4 Filter and Floater

Check (to perform every 4h)

The filter has to be clean and it is important that nothing blocks or reduces the floater mobility. The filter has to be clean to avoid that water or dirt goes inside the vacuum motor, the floater has to be free to move and has to block completely the air flow when it is in blocking position (UP).

Maintenance (to perform every 4h)

- Put the machine in safe conditions.
- Check that the tank recovery compartment is completely empty.
- Remove the Recovery compartment lid.
- Loose the filter protection and remove the filter. Verify that the filter ball is free to move and intact.

- Remove and clean (replace if necessary) the filter.

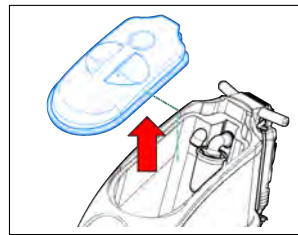

7.4.4-88 Recovery Tank Lid

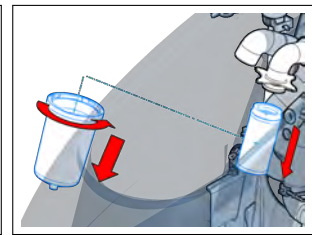

7.4.4-89 Filter Cup and Ball Filter

7.4.5 Tank Recovery Compartment

Check (to perform every 150h)

The recovery tank has to be clean and has not to have cracks or, in general, any kind of damage. The Lid housing has to be even and flat to allow the gasket to adhere perfectly to the tank to avoid any air infiltration. The hose fittings have to be in optimum condition in order to avoid any pressure drop during the suction or dirty water leakage when the machine has finished the labor.

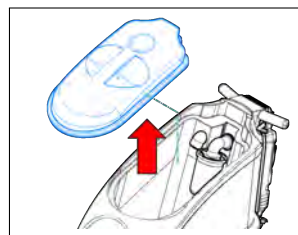

7.4.5-90 Vacuum Cover

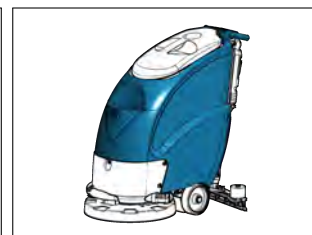

7.4.5-91 Recovery Compartment

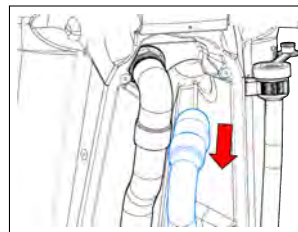

7.4.5-92 Vacuum Hose

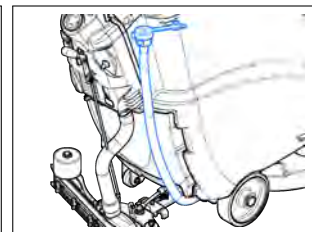

7.4.5-93 Filling Hose

7.4.6 Vacuum Motor

Check (to perform every 150h)

The vacuum motor with the vacuum hose disconnected from the squeegee has to **absorb** less than **13,5 Amps**.

The motor should rotate evenly and smoothly and doesn't have to produce unusual noises. The motor contacts have to be clean, they have not to show signs of wear or heating in general.

The motor wires insulation has to be intact in all its parts and does not show signs of cracks. The single cable have to be flexible.

The magnetic circuit of the motor has to be in good conditions and clean.

The carbon brushes must be 6-8 mm long and they have not to be abnormally worn out.

Maintenance (to perform every 450h)

- Put the machine in safe conditions.
- Disassemble the motor from the machine (see section 4.3.9 at page 25).
- Remove the cooler fan plastic cover from the motor (see fig. 7.4.6-94).
- Slip off the motor carbon brushes (see fig. 7.4.6-95)
- Replace the worn out carbon brushes with new ones.
- Proceed at reverse to restore the parts.

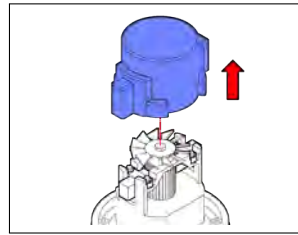

7.4.6-94 Plastic cover re-

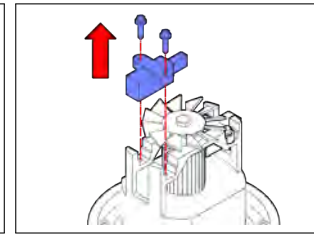

7.4.6-95 Carbon brush re-
moval

7.4.7 Drain Hose

Check (to perform every 4h)

The Drain Hose has to be perfectly fitted in the recovery tank fittings. The Drain Cap has to seal perfectly the hose to avoid any pressure drop or dirty water leakage. The Drain Flexible Manifold has to be flexible and has to have no cracks to avoid any break down during the bending to drain the machine.

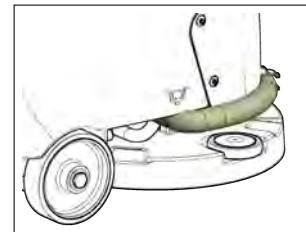

7.4.7-96 Drain Hose

7.5 Technical Features

TECHNICAL DESCRIPTION	U/M	My50 B
Squeegee width	mm	680
Optional Squeegee width	mm	780
Recovery Tank	l	37
Vacuum Motor Stages	Nr	2
Vacuum Motor Power	W	310
Vacuum Motor Voltage	V	24
Vacuum Motor Depression	<i>mmH₂O</i>	1065

7.6 Consumable Spare Parts

PN	Description
680 mm Squeegee	
219451	KIT SQUEEGEE BLADES 33 SHORE
219452	KIT SQUEEGEE BLADES 40 SHORE PU
219453	KIT SQUEEGEE BLADES LATEX
405682	WHEEL
Optional 780 mm Squeegee	
221391	KIT SQUEEGEE BLADES 33 SHORE SP=4
221392	KIT SQUEEGEE BLADES 40 SHORE PU SP=4
221393	KIT SQUEEGEE BLADES LATEX SP=4
405682	WHEEL
Carbon Brushes	
424210	VACUUM MOTOR CARBON BRUSHES

7.7 Recommended Spare Parts

PN	Description
430956	BUMPER WHEEL D=80 d=12 H=60
430957	STRAIGHT ADAPTER D=40
433681	GAS SPRING 200N L=274
219723	VACUUM MOTOR ASSY
433652	FLOATER PROTECTION D.110 x 182
412363	CARTRIDGE FILTER ASSEMBLY D=60 H=130
424552	DRAIN HOSE D.38X985 W/CAP
432150	VACUUM HOSE D. 38X1310 W/ELBOW

Chapter 8

Machine Frame and Traction System

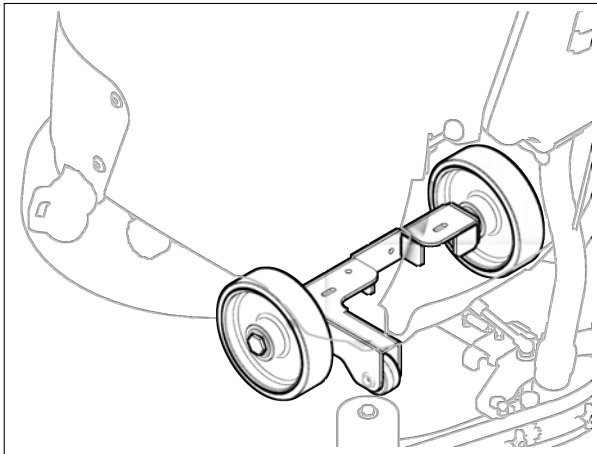

8-50

8.1 Structure

- Frame
- Front Wheels
- Rear Wheel

8.2 Description

The frame is a single structure on which is mounted the tank.

The machine traction is ensured by the mechanical friction system.

The front wheels are directly fixed to the frame with pins, as well as the rear parking wheel.

8.3 Maintenance and Checks

8.3.1 Wheels

Check (to perform every **150h**)

The wheel must be free to rotate smoothly without friction. The wheel surface, must always be in good condition.

Maintenance (to perform every **600h**)

Periodically check the condition of the bearings and bushings of the wheels. If necessary, replace the part (see section [4.4.1](#) at page [27](#)).

8.4 Technical Features

TECHNICAL DESCRIPTION	U/M	My50 B
Front wheel (num/diam/width)	(Nr/ ϕ mm/mm)	2/172.5/45.5
Front wheel material		Thermoplastic Polyurethane
Front wheel hardness	Sh	80

8.5 Consumable Spare Parts

PN	Description
420679	FRONT WHEEL D=172.5 L=45.5 WITH BEARINGS
405682	WHEEL D=52 d=12,5 S=28

Chapter 9

Cleaning Solution Supply System

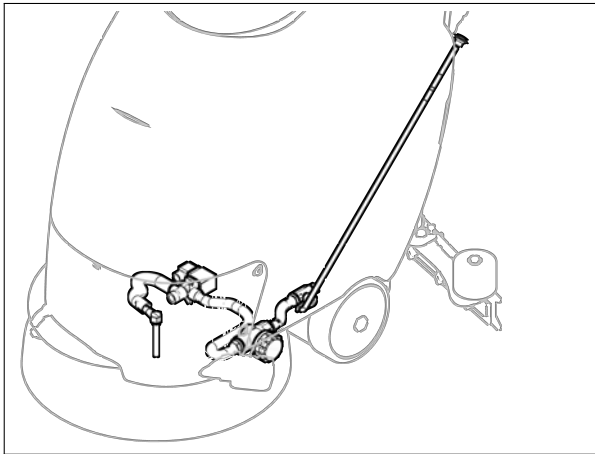

9.1 Structure

- Tank Solution Compartment
- Hoses
- Water Valve
- Solution Filter
- Solenoid Valve
- Distributor

9.2 Description

The Cleaning Solution Supply System is made by a compartment housed in the tank commonly called solution compartment or clean water compartment.

In this compartment the clean water is mixed with the detergent to create the cleaning solution that the machine will use to clean.

The solution is then canalized to the water valve and the filter. **The water valve** is used to adjust the solution that will fall on the floor in order to have the correct amount of solution required for washing. **The filter** is used to stop debris that could stuck the hose system and compromise the proper functioning of the system.

Once passed through the water valve the solution arrive to the solenoid valve that blocks the delivery when the brush is not working and allow the flow while brush works.

The end of the solution path is the distributor that canalizes the flow in the middle of the brush.

9-52

9.3 Maintenance and Checks

9.3.3 Water Valve

9.3.1 Solution Compartment

Check (to perform every 50h)

The solution compartment has to be clean and intact. It has not to have cracks or any other kind of damage. Verify, when the compartment is completely filled up, that there are not leakage. If necessary replace the Tank (see section 4.3.6 at page 24).

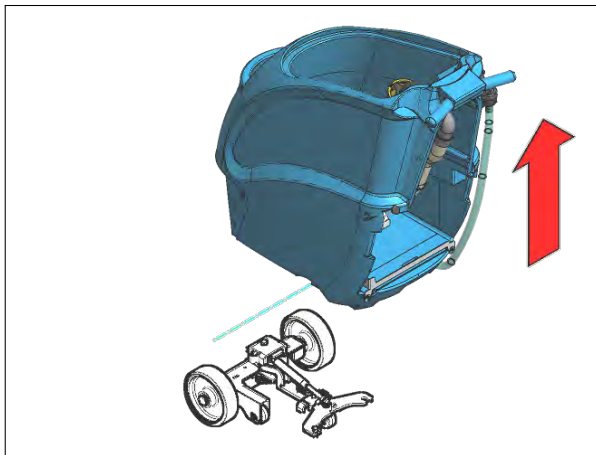

Figure 9.1: Solution compartment

9.3.2 Hoses

Check (to perform every 50h)

Every single hose has to be intact and has not to be worn out. It is extremely important that the hoses kept the original flexibility and they haven't suffered any chemical reaction with the detergent used with the machine. If necessary proceed with the replacement of the damaged hoses (see section 4.5.2 at page 27).

Check (to perform every 50h)

It is extremely important that when adjusted at minimum the valve blocks completely the water flow and it is mechanically free to move for its whole stroke.

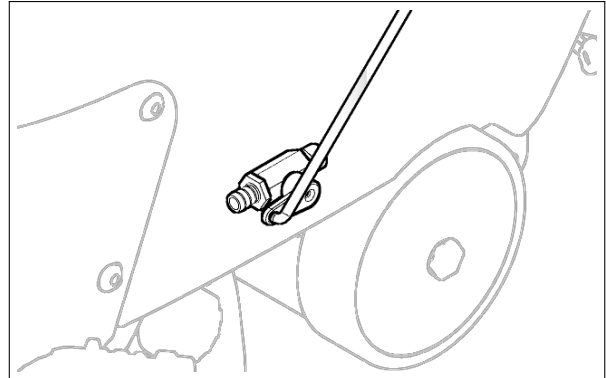

Figure 9.2: Water Valve

9.3.4 Clean Water Filter

Check (to perform every 4h)

The filter has to be periodically cleaned. When it is fitted on the machine no leakage has to be present. The filter cartridge has to be intact and has not to present any anomaly.

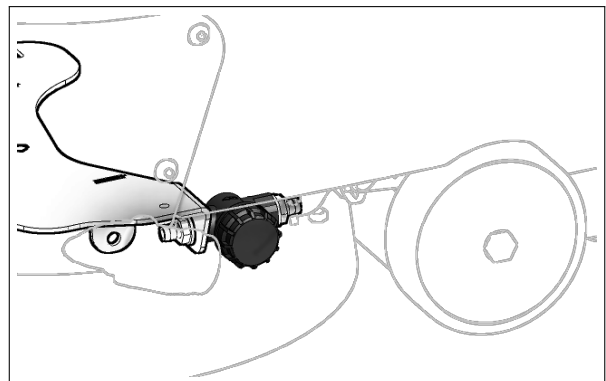

Figure 9.3: Clean Water Filter

9.3.5 Solenoid Valve

Check (to perform every **50h**)

The solenoid valve has to block completely the solution flow when the brush deck is not working. Viceversa it has to grant the full flow rate when the brush deck is working.

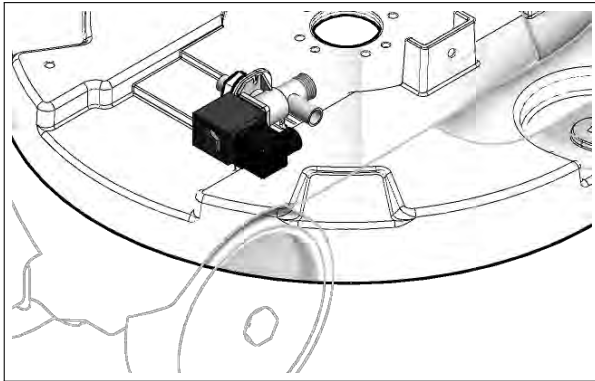

Figure 9.4: Solenoid Valve

9-54

9.3.6 Distributor

Check (to perform every **150h**)

The distributor has to be intact and has to grant the proper solution flow without any leakage in the gearbox.

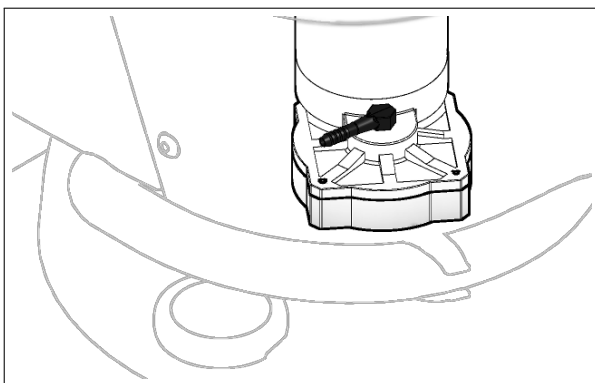

Figure 9.5: Distributor

9.4 Technical Features

TECHNICAL DESCRIPTION	U/M	My50 B
Tank Solution Compartment	1	36
Clean Water Filter		Steel cartridge
Water Valve		Steel ball valve

9.5 Recommended Spare Parts

PN	Description
212616	FILTER 1/2" F/F COMPL.
407887	COMPLETE SOLENOID 24V 1/2"

Part IV

Accessories and Add-On

9-56

Chapter 10

Accessories

10.1 Accessories List

- Onboard Charger Kit

10.2 Onboard Charger Kit - 220851

10.2.1 Description

The machine is available in "CB" version which is the version with the built in charger. Anyway, in a standard machine without the built in charger, it is possible to install the charger afterwards by following the below instructions.

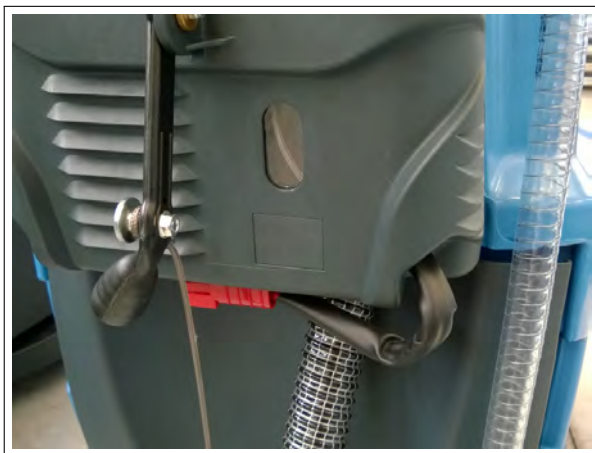

10.2.2 Machine Preparation

Before to start the kit installation is mandatory to put the machine in safe condition. Release the brush, switch off the machine and unplug the battery connector.

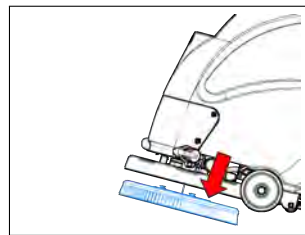

10.2.2-1 Brush release

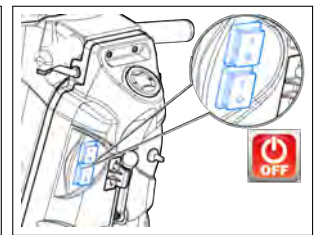

10.2.2-2 Machine switching off

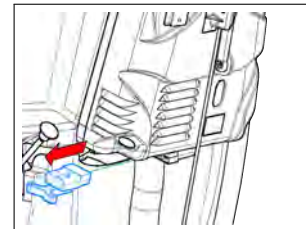

10.2.2-3 Unplug of battery connector

10.2.3 Installing instructions

- Make sure that the set up of the charger matches the type of battery actually installed on the machine (see section 5.8.3 at page 35).
- Lower the Squeegee to the floor.
- Open the external dashboard by loosening the screws.
- Install the charger inside the electrical system compartment and secure it with screws to the provided holes.
- Connect the charger power wires to the machine harness.
- Connect the charger safety wires to the machine harness.
- Bend together the harness with plastic clamps.

- Install the rubber cap for the charger socket.
- Remove the plastic cover from the dashboard to open the entrance of the charger socket.

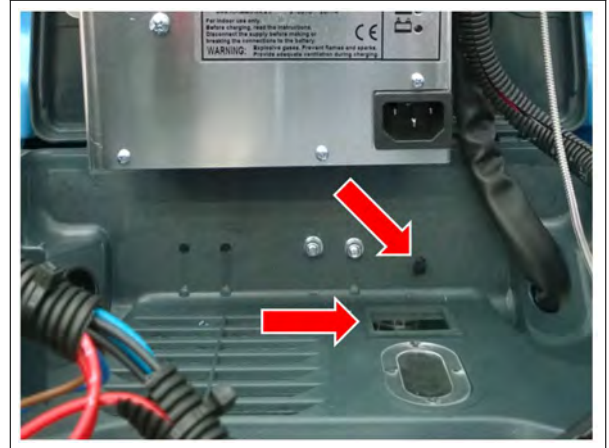

- Close the external dashboard with the screws.
- Perform a functional test.

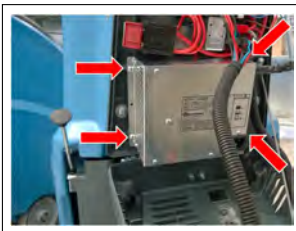

10.2.3-4 Housing



10.2.3-5 Power wires

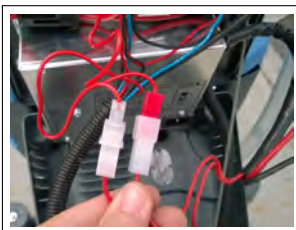

10.2.3-6 Safety wires



10.2.3-7





Fimap S.p.A.
Workshop Handbook My50

Fimap S.p.A. Via Invalidi del Lavoro, 1 - 37050 S.Maria di Zevio Verona - ITALY
Tel. +39 045 6060411 - Fax +39 045 6060417
Edition: September 29, 2014