

PARTS LIST

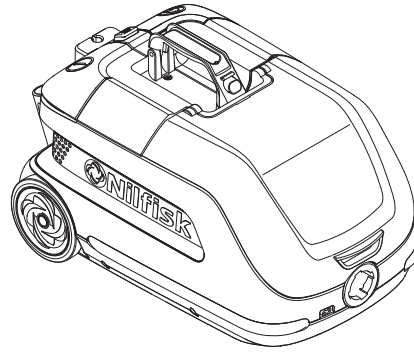

2021.08.30

TABLE OF CONTENTS

Overview	1
Accessories	3
Recommended spare parts	5

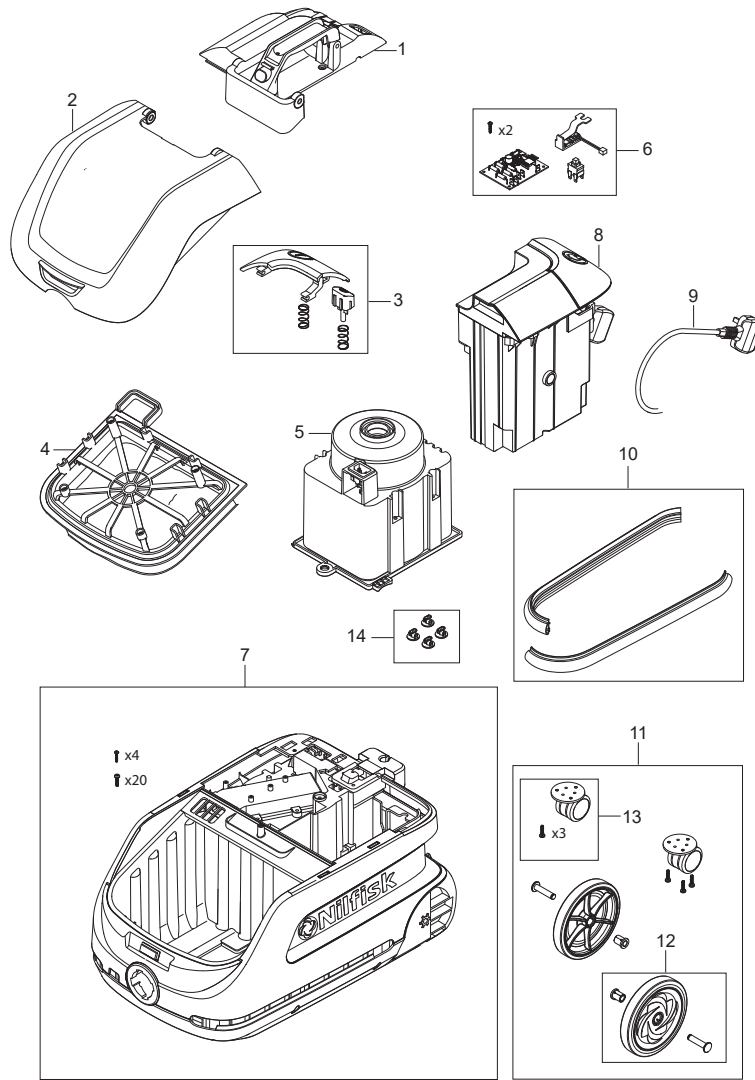

Pos.	Artikel-Nr.	Menge	Variante	Notes
0	107416446	1	BOX KIT FOR VP600	[1]
1	107414237	1	HANDLE KIT WITHOUT DUAL	[2]
1	107413062	1	Griffkit VP600	[3]
2	107413059	1	LID	
3	107413064	1	BOTTON KIT	
4	107413056	1	Einlegetuchfilter	
5	107413052	1	MOTORMODUL EU	
5	107413053	1	MOTORMODUL US	
5	107413054	1	MOTORMODUL JP	
6	107413067	1	PCB KIT EU	[4]
6	107413068	1	PCB KIT CN	[4]
6	107418963	1	PCB KIT ECO	[5]
7	107413058	1	PLASTIC KIT	
7	107413066	1	BODY KIT	
8	107413042	1	POWER MODUL FIXED UK	
8	107413043	1	Netzkabelmodul festes Kabel	
8	107413044	1	Netzkabelmodul steckbar	
8	107413045	1	POWER MODULE DETACH AUS/NZ	
8	107413046	1	POWER MODUL DETACH CN	
8	107413047	1	POWER MODUL DETACH US	
8	107413048	1	Netzkabelmodul Kabelaufwicklung	
8	107413049	1	POWER MODUL REWINDER AUS/NZ	
8	107413050	1	POWER MODUL REWINDER JP	
8	107413051	1	POWER MODUL REWINDER UK	
9	107402678	1	DETACH CORD SET 10M ORG AUS/NZ	
9	140 6800 650	1	Netzkabel fest 10m	
9	140 6643 580	1	CORD SET 10.5M UK	
9	107413071	1	POWERCORD DETACHABLE CN	
9	107402901	1	Netzkabel 15 m, abnehmbar, orange	
9	107413073	1	POWERCORD DETACHABLE US	
10	107413065	1	BUMPER KIT	
11	107413055	1	WHEEL KIT	
12	107413063	1	WHEEL KIT BACK	
13	147 1040 500	1	Drehrad kompl. zuExtreme/GM 430	
14	107413069	1	Q TURN	

Part Notes:

- [1] - 10 pcs.
- [2] - Without dual
- [3] - Dual
- [4] - AE-COM-LI-vac 2015-002 - VP600 PCB
- [5] - ECO

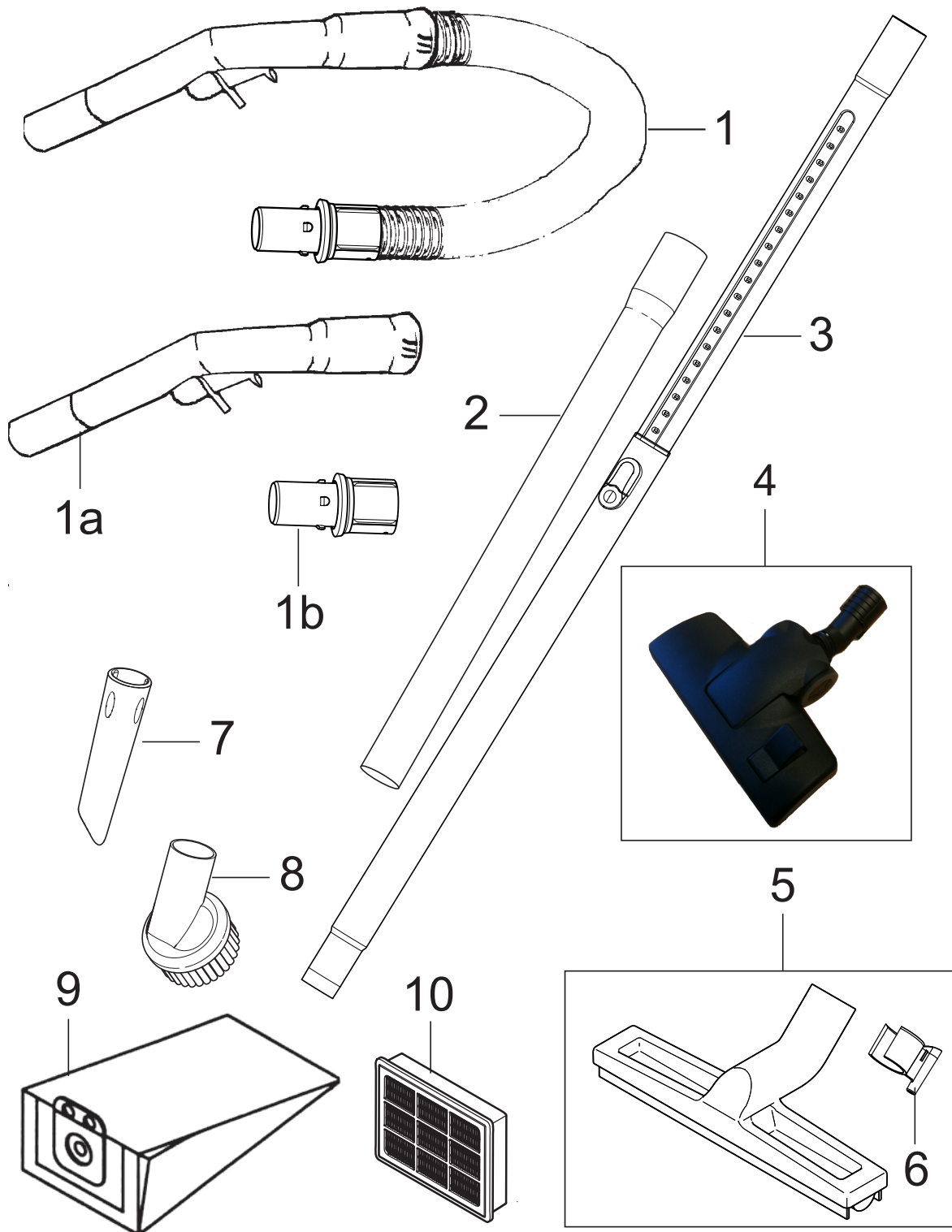

Pos.	Artikel-Nr.	Menge	Variante	Notes
1	107415116	1	Saugschlauch kpl. antist., schwarz 2,5m	
1	147 0765 500	1	Saugschlauch kpl. Ø 32 mmx2,5 m	
1a	107417894	1	BENT END AND CONNECTOR FOR D32	
1b	107416215	1	HOSE CONNECTION ABS	
2	011 6431 500	1	Verlängerungsrohr Alu Ø 32x500 mm	
3	011 8130 500	1	Teleskoprohr Alu Ø 32 mm	
4	107417790	1	Kombibodendüse RD295P mit Clip	[1]
4	107413075	1	Kombidüse Ø 32x292mm	
5	107413081	1	Hartbodendüse 495mm	
5	107413080	1	Hartbodendüse m. Clip, 350 mm, grau	
5	140 6700 540	1	Hartbodendüse Ø 32 mm	
6	147 0585 500	1	Verstauklemme schwarz	
7	147 0146 500	1	Konische Düse Ø 32 mm	
8	140 8244 500	1	Pinseldüse Ø 32 mm	
9	107413076	1	Staubbeutel Vlies, VPE 10	
9	107413077	1	Staubbeutel Papier, VPE 10	
10	107409854	1	HEPA-Filter H14 Elite	
10	147 1250 500	1	HEPA FILTER H13	

Part Notes:

[1] - Only CN

Pos.	Artikel-Nr.	Menge	Variante	Notes
1	107413064	1	BOTTON KIT	
2	107413056	1	Einlegetuchfilter	
3	107413052	1	MOTORMODUL EU	
4	107413053	1	MOTORMODUL US	
5	107413054	1	MOTORMODUL JP	
6	107413067	1	PCB KIT EU	
7	107413068	1	PCB KIT CN	
8	107413042	1	POWER MODUL FIXED UK	
9	107413043	1	Netzkabelmodul festes Kabel	
10	107413044	1	Netzkabelmodul steckbar	
11	107413045	1	POWER MODULE DETACH AUS/NZ	
12	107413046	1	POWER MODUL DETACH CN	
13	107413047	1	POWER MODUL DETACH US	
14	107413048	1	Netzkabelmodul Kabelaufwicklung	
15	107413049	1	POWER MODUL REWINDER AUS/NZ	
16	107413050	1	POWER MODUL REWINDER JP	
17	107413051	1	POWER MODUL REWINDER UK	
18	107402678	1	DETACH CORD SET 10M ORG AUS/NZ	
19	140 6800 650	1	Netzkabel fest 10m	
20	140 6643 580	1	CORD SET 10.5M UK	
21	107413071	1	POWERCORD DETACHABLE CN	
22	107402901	1	Netzkabel 15 m, abnehmbar, orange	
23	107413073	1	POWERCORD DETACHABLE US	
24	107413055	1	WHEEL KIT	
25	107413069	1	Q TURN	

